

# 2020/21

## *STEERING & SUSPENSION PARTS CATALOGUE*

FOR PASSENGER & LIGHT COMMERCIAL VEHICLES



 **teknosa**<sup>®</sup>  
STEERING & SUSPENSION PARTS

[www.teknosa.co.za](http://www.teknosa.co.za)

## **ABOUT US**

Teknosa Automotive is one of the leading suppliers of Automotive Spare Parts in Southern Africa. Our product range is by far the most extensive. our range extends to all vehicles in SADC countries.

We are constantly developing new applications, to meet the demands of the aftermarket industry which is a key success factor for driving our growth.

## **ABOUT OUR PRODUCT**

Our attention to even the smallest detail has made our brand synonymous with Quality & Reliability, making our brand the most popular, by choice.

## **BRAND QUALITY**

Our Automotive Spare Parts are engineered and manufactured in accordance with the highest quality manufacturing standards. All Teknosa Steering and Suspension Parts are manufactured by ISO/TS 16949 and ISO 14001 accredited manufacturers. Our state of the art production facilities feature technologically advanced, ultra-precision equipment and integrated operations to deliver our brand of quality Automotive Spare Parts for most vehicle applications.

## **DISCLAIMER**

The information listed here-in have been compiled to the best of our knowledge and from reliable sources and, is for reference and guide purposes only. Teknosa Automotive cannot be held responsible for errors and interpretation. E&OE

## **WARRANTY**

Our brand is sold with a 12-month warranty against manufacturing defects and malfunction, provided that our product is fitted by accredited fitment centres and qualified technicians. This warranty does not extend to normal wear & tear, neglect and damage.

---

“The Contents of this catalogue are protected by copyright. Unlawful use of the contents will result in prosecution.”

All Teknosa Suspension Parts listed, sold or supplied is offered and sold as replacement parts only.



# CATALOGUE IDENTIFICATION

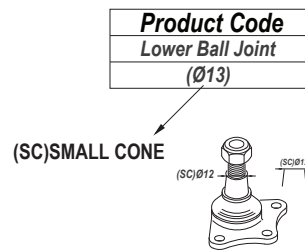
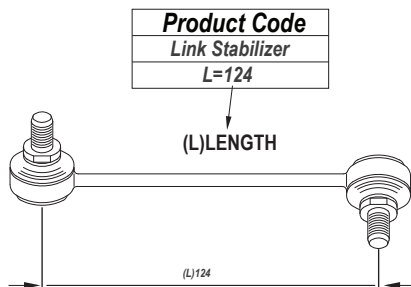
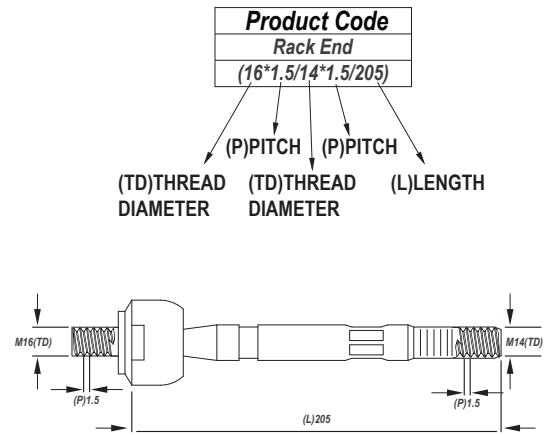
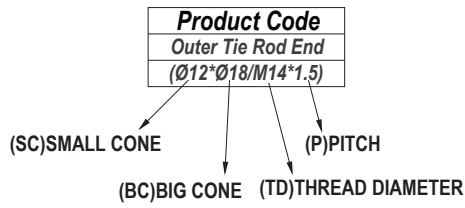

## PARALLELOGRAM STEERING

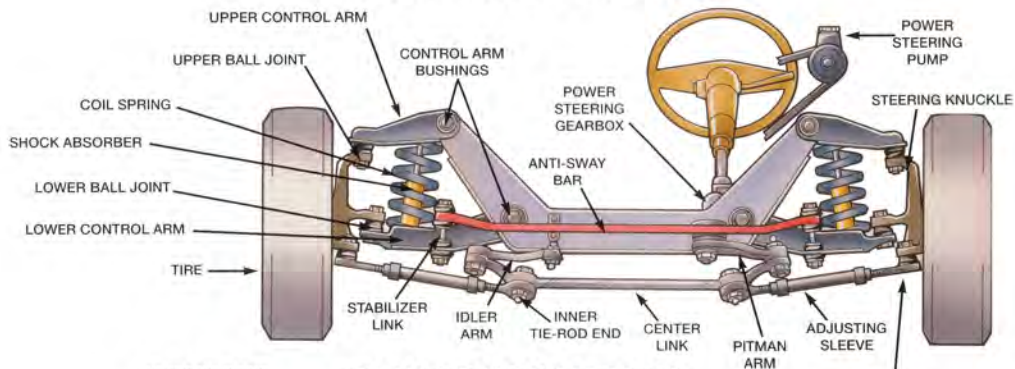

## RACK & PINION STEERING

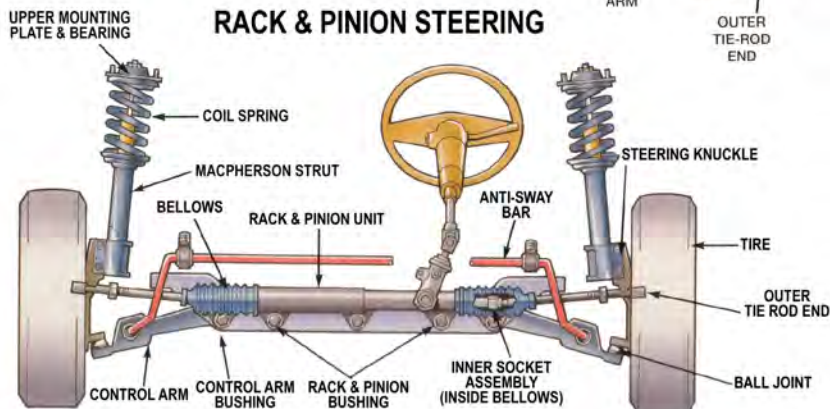

## INDEX

<b>ALFA ROMEO</b>	<b>1</b>	<b>-</b>	<b>8</b>
<b>AUDI</b>	<b>9</b>	<b>-</b>	<b>46</b>
<b>BMW</b>	<b>47</b>	<b>-</b>	<b>94</b>
<b>CAM</b>	<b>95</b>	<b>-</b>	<b>96</b>
<b>CHANA</b>	<b>97</b>	<b>-</b>	
<b>CHERY</b>	<b>98</b>	<b>-</b>	<b>99</b>
<b>CHEVROLER</b>	<b>100</b>	<b>-</b>	<b>110</b>
<b>CHRYSLER</b>	<b>111</b>	<b>-</b>	<b>115</b>
<b>CITROEN</b>	<b>116</b>	<b>-</b>	<b>130</b>
<b>CMC</b>	<b>131</b>	<b>-</b>	
<b>DAEWOO</b>	<b>132</b>	<b>-</b>	<b>136</b>
<b>DAIHATSU</b>	<b>137</b>	<b>-</b>	<b>143</b>
<b>DATSUN</b>	<b>144</b>	<b>-</b>	
<b>DODGE</b>	<b>145</b>	<b>-</b>	<b>147</b>
<b>FIAT</b>	<b>148</b>	<b>-</b>	<b>167</b>
<b>FORD</b>	<b>168</b>	<b>-</b>	<b>206</b>
<b>FOTON</b>	<b>207</b>	<b>-</b>	<b>209</b>
<b>GONOW</b>	<b>210</b>	<b>-</b>	
<b>GWM</b>	<b>211</b>	<b>-</b>	
<b>HONDA</b>	<b>212</b>	<b>-</b>	<b>234</b>
<b>HYUNDAI</b>	<b>235</b>	<b>-</b>	<b>270</b>
<b>ISUZU</b>	<b>271</b>	<b>-</b>	<b>278</b>
<b>IVECO</b>	<b>279</b>	<b>-</b>	
<b>JAGUAR</b>	<b>280</b>	<b>-</b>	<b>286</b>
<b>JEEP</b>	<b>287</b>	<b>-</b>	<b>296</b>
<b>KIA</b>	<b>297</b>	<b>-</b>	<b>324</b>
<b>LAND ROVER</b>	<b>325</b>	<b>-</b>	<b>337</b>
<b>MAHINDRA</b>	<b>338</b>	<b>-</b>	<b>341</b>
<b>MAZDA</b>	<b>342</b>	<b>-</b>	<b>375</b>
<b>MERCEDES</b>	<b>376</b>	<b>-</b>	<b>434</b>
<b>MINI</b>	<b>435</b>	<b>-</b>	<b>438</b>
<b>MITSUBISHI</b>	<b>439</b>	<b>-</b>	<b>453</b>
<b>NISSAN</b>	<b>454</b>	<b>-</b>	<b>494</b>
<b>OPEL</b>	<b>495</b>	<b>-</b>	<b>517</b>
<b>PEUGEOT</b>	<b>518</b>	<b>-</b>	<b>544</b>
<b>PORSCHE</b>	<b>545</b>	<b>-</b>	<b>550</b>
<b>PROTON</b>	<b>551</b>	<b>-</b>	
<b>RENAULT</b>	<b>552</b>	<b>-</b>	<b>580</b>
<b>ROVER</b>	<b>581</b>	<b>-</b>	
<b>SAAB</b>	<b>582</b>	<b>-</b>	<b>587</b>
<b>SEAT</b>	<b>588</b>	<b>-</b>	<b>593</b>
<b>SMART</b>	<b>594</b>	<b>-</b>	<b>595</b>
<b>SSANGYONG</b>	<b>596</b>	<b>-</b>	<b>598</b>
<b>SUBARU</b>	<b>599</b>	<b>-</b>	<b>604</b>
<b>SUZUKI</b>	<b>605</b>	<b>-</b>	<b>614</b>
<b>TATA</b>	<b>615</b>	<b>-</b>	<b>618</b>
<b>TOYOTA</b>	<b>619</b>	<b>-</b>	<b>670</b>
<b>VOLKSWAGEN</b>	<b>671</b>	<b>-</b>	<b>716</b>
<b>VOLVO</b>	<b>717</b>	<b>-</b>	<b>741</b>



**ALFA ROMEO**

145-146

FRONT

2.0 QUADROFOGLIO-2.0TI

Year

1996-2001

**AF1010**  
Outer Tie Rod End  
(Ø12\*Ø13.35/M12\*1.5)



**AF1310**  
Outer Tie Rod End Set  
(Ø12\*Ø13.35/M12\*1.5)

**AF1011**  
Outer Tie Rod End  
(Ø12\*Ø13.35/M12\*1.5)



**AF1410**  
Rack End  
(14\*1.5 /12\*1.5/288)

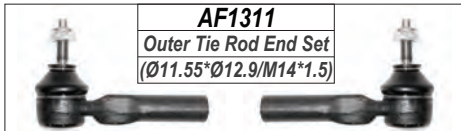

**AF1311**  
Outer Tie Rod End Set  
(Ø11.55\*Ø12.9/M14\*1.5)

**AF1012**  
Outer Tie Rod End  
(Ø11.55\*Ø12.9/M14\*1.5)



**AF1411**  
Rack End  
(14\*1.5 /12\*1.5/270)



**AF1012**  
Outer Tie Rod End  
(Ø11.55\*Ø12.9/M14\*1.5)



**AF1312**  
Outer Tie Rod End Set  
(Ø12.6\*Ø14.5/M18\*1.5)

**AF1013**  
Outer Tie Rod End  
(Ø12.6\*Ø14.5/M18\*1.5)



**AF1412**  
Rack End  
(14\*1.5 /14\*1.5/293)



**AF1014**  
Outer Tie Rod End  
(Ø12.6\*Ø14.5/M18\*1.5)



**AF1015**  
Outer Tie Rod End  
(Ø12\*Ø13.35/M14\*1.5)

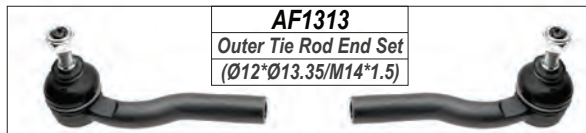

**AF1313**  
Outer Tie Rod End Set  
(Ø12\*Ø13.35/M14\*1.5)

**AF1016**  
Outer Tie Rod End  
(Ø12\*Ø13.35/M14\*1.5)



**AF1510**  
Link Stabilizer  
L=99



**AF2113**  
Stabilizer Bar Bush



**AF2112**  
Lower Control Arm Bush



**AF2113**  
Stabilizer Bar Bush



**AF2010**  
Lower Control Arm

**AF2011**  
Lower Control Arm

**AF2810**  
Shock Mounting



**AF2811**  
Shock Mounting



**AF2110 / AF2111**  
Lower Control Arm Bush

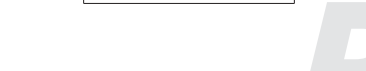

LEFT

RIGHT

**ALFA ROMEO**

147-156-GT

FRONT

1.6TS.2.0 SELESPEED TS.TS.2.0TS.2.5V6

Year

1997-2010

**AF1017**  
Outer Tie Rod End  
(Ø12.57\*Ø18.3/M14\*1.5)

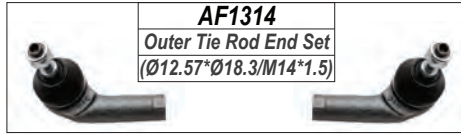

**AF1314**  
Outer Tie Rod End Set  
(Ø12.57\*Ø18.3/M14\*1.5)

**AF1018**  
Outer Tie Rod End  
(Ø12.57\*Ø18.3/M14\*1.5)



**AF1413**  
Rack End  
(16\*1.5/14\*1.5/205)



**AF1511**  
Link Stabilizer  
L=124



**AF1710**  
Upper Control Arm



**AF1711**  
Upper Control Arm

**AF2114**  
Lower Control Arm Bush

**AF2112**  
Lower Control Arm Bush

**AF2114**  
Lower Control Arm Bush



**AF2012**  
Lower Control Arm

**AF2013**  
Lower Control Arm

**AF2812**  
Shock Mounting



**AF2812**  
Shock Mounting



**AF2115 / AF2116**  
Lower Control Arm Bush

147-156-GT

REAR

**AF1512**  
Link Stabilizer  
L=180



**AF1514**  
Link Stabilizer  
L=560



**AF1513**  
Link Stabilizer  
L=594



LEFT

RIGHT

**ALFA ROMEO**

155-GTV SPIDER FRONT

2.0TS.2.5V6

Year

1996-1999

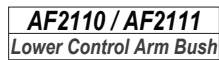
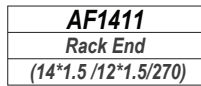
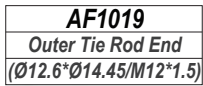
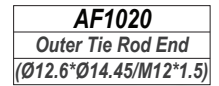
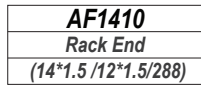
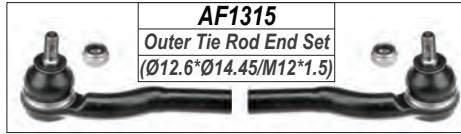

LEFT

RIGHT



**ALFA ROMEO**

159

FRONT

SALOON.SPORTSWAGON

Year

2005-

**AF1021**  
Outer Tie Rod End  
(Ø14.6\*Ø16.6/M20\*1.5)

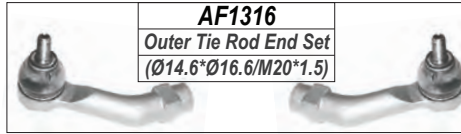

**AF1316**  
Outer Tie Rod End Set  
(Ø14.6\*Ø16.6/M20\*1.5)

**AF1414**  
Rack End  
(16\*1.5 /20\*1.5/213)



**AF1022**  
Outer Tie Rod End  
(Ø14.6\*Ø16.6/M20\*1.5)

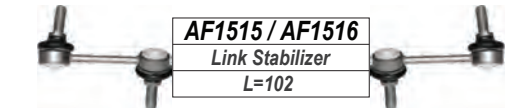

**AF1515 / AF1516**  
Link Stabilizer  
L=102



**AF1517 / AF1518**  
Link Stabilizer  
L=116



**AF1712**  
Upper Control Arm

**AF1713**  
Upper Control Arm



**AF2014**  
Lower Control Arm

**AF2015**  
Lower Control Arm

**AF2813**  
Shock Mounting



**AF2813**  
Shock Mounting



**AF2117/AF2118**  
Lower Control Arm Bush



159

REAR

**AF2814**  
Shock Mounting



**AF2814**  
Shock Mounting



LEFT

RIGHT

**ALFA ROMEO**

164

FRONT

3.0 SUPER

Year

1993-1999

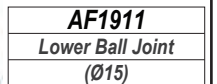
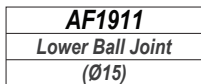
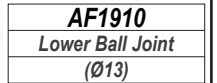
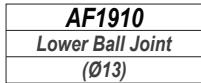
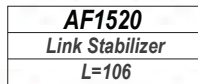
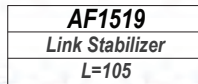
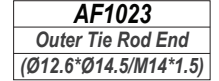
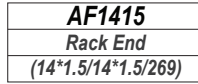
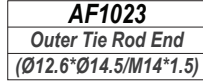

LEFT

RIGHT

**ALFA ROMEO**

166

FRONT

3.0 SPORTRONIC

Year

1998-2007

**AF1017**  
Outer Tie Rod End  
(Ø12.57\*Ø14.4/M14\*1.5)

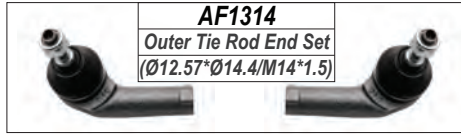

**AF1314**  
Outer Tie Rod End Set  
(Ø12.57\*Ø14.4/M14\*1.5)

**AF1416**  
Rack End  
(16\*1.5/14\*1.5/217)



**AF1018**  
Outer Tie Rod End  
(Ø12.57\*Ø14.4/M14\*1.5)



**AF1524**  
Link Stabilizer  
L=145



**AF1714**  
Upper Control Arm

**AF1715**  
Upper Control Arm



**AF2020**  
Lower Control Arm

**AF2021**  
Lower Control Arm

**AF2812**  
Shock Mounting



**AF2812**  
Shock Mounting



166

REAR

**AF1526**  
Link Stabilizer  
L=180



**AF1522**  
Link Stabilizer  
L=95



**AF2022**  
Lower Control Arm



**AF2023**  
Lower Control Arm



**AF1526**  
Link Stabilizer  
L=180



**AF1523**  
Link Stabilizer  
L=95



**AF1521**  
Link Stabilizer  
L=137



LEFT

RIGHT



**ALFA ROMEO**

GIULIETTA

FRONT

940

Year

2010-

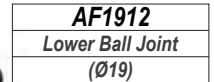
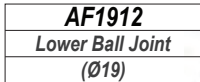
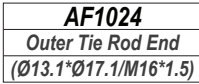
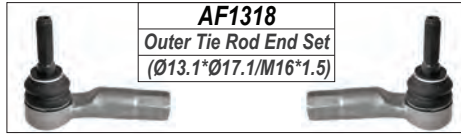

**LEFT**

**RIGHT**

**ALFA ROMEO**

MITO

FRONT

955

Year

2008-

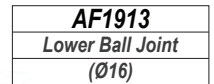
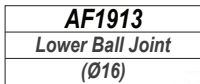
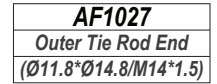
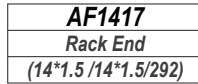
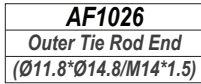
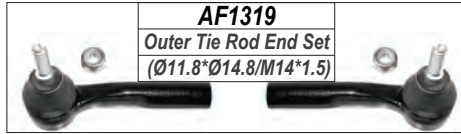

**LEFT**

**RIGHT**

**AUDI**

**500**

**FRONT**

**2.3E.SE.2.8SEL**

*Year*

**1992-1994**

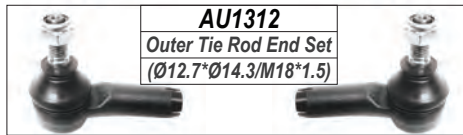
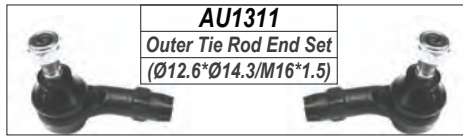

<b>AU1012</b>	
<i>Outer Tie Rod End</i>	
<i>(Ø12.6*Ø14.3/M16*1.5)</i>	



<b>AU1013</b>	
<i>Outer Tie Rod End</i>	
<i>(Ø12.6*Ø14.3/M16*1.5)</i>	



<b>AU1014</b>	
<i>Outer Tie Rod End</i>	
<i>(Ø12.6*Ø14.3/M16*1.5)</i>	



<b>AU1015</b>	
<i>Outer Tie Rod End</i>	
<i>(Ø12.6*Ø14.3/M16*1.5)</i>	



<b>AU1212 / AU1213</b>	
<i>Tie Rod Assembly</i>	



<b>AU2112</b>	
<i>Lower Control Arm Bush</i>	



<b>AU2110</b>	
<i>Lower Control Arm Bush</i>	



<b>AU2014</b>	
<i>Lower Control Arm</i>	



<b>AU2015</b>	
<i>Lower Control Arm</i>	



<b>AU2110</b>	
<i>Lower Control Arm Bush</i>	



**500**

**REAR**

<b>AU1510</b>	
<i>Link Stabilizer</i>	
<i>L=122.50</i>	



<b>AU2310 / AU2311</b>	
<i>Drag Link</i>	



**LEFT**

**RIGHT**



**AUDI**

A1

FRONT

ALL

Year

2011-

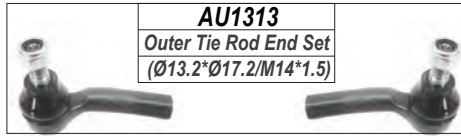

**AU1313**  
Outer Tie Rod End Set  
(Ø13.2\*Ø17.2/M14\*1.5)

**AU1016**  
Outer Tie Rod End  
(Ø13.2\*Ø17.2/M14\*1.5)



**AU1410**  
Rack End  
(14\*1.5 /14\*1.5/310)



**AU1017**  
Outer Tie Rod End  
(Ø13.2\*Ø17.2/M14\*1.5)

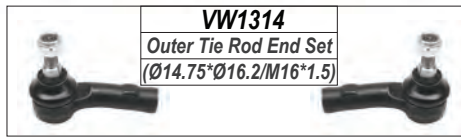

**VW1314**  
Outer Tie Rod End Set  
(Ø14.75\*Ø16.2/M16\*1.5)

**VW1019**  
Outer Tie Rod End  
(Ø14.75\*Ø16.2/M16\*1.5)



**VW1420**  
Rack End  
(14\*1.5 /16\*1.5/293)



**VW1020**  
Outer Tie Rod End  
(Ø14.75\*Ø16.2/M16\*1.5)

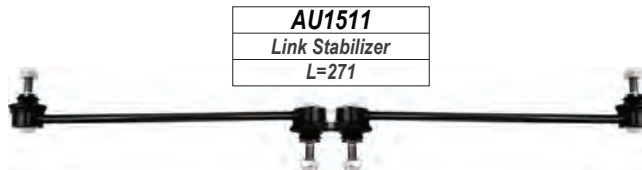

**AU1511**  
Link Stabilizer  
L=271

**AU1913**  
Lower Ball Joint  
(Ø14.9)



**AU2113**  
Lower Control Arm Bush



**AU1914**  
Lower Ball Joint  
(Ø14.9)



**AU2016**  
Lower Control Arm

**AU2017**  
Lower Control Arm

**AU2814**  
Shock Mounting



**AU2114**  
Lower Control Arm Bush



**AU2814**  
Shock Mounting



A1

REAR

**AU2815**  
Shock Mounting



**AU1512**  
Link Stabilizer  
(M10\*1.5/L70.2MM)



**AU2815**  
Shock Mounting



LEFT

RIGHT

**AUDI**

**A3**

**FRONT**

**ALL**

*Year*

**1998-2002**

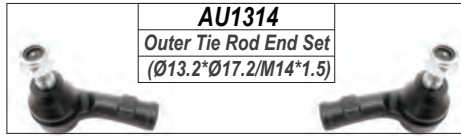

**AU1314**  
Outer Tie Rod End Set  
(Ø13.2\*Ø17.2/M14\*1.5)

**AU1018**  
Outer Tie Rod End  
(Ø13.2\*Ø17.2/M14\*1.5)

**AU1412**  
Rack End  
(16\*1.5 /14\*1.5/341)

**AU1019**  
Outer Tie Rod End  
(Ø13.2\*Ø17.2/M14\*1.5)

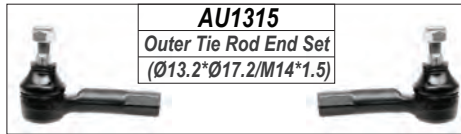

**AU1315**  
Outer Tie Rod End Set  
(Ø13.2\*Ø17.2/M14\*1.5)

**AU1020**  
Outer Tie Rod End  
(Ø13.2\*Ø17.2/M14\*1.5)

**AU1411**  
Rack End  
(16\*1.5 /14\*1.5/320)

**AU1021**  
Outer Tie Rod End  
(Ø13.2\*Ø17.2/M14\*1.5)

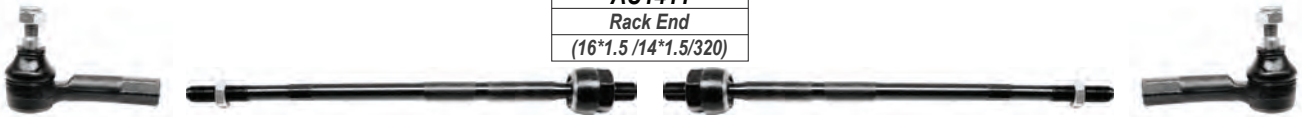

**AU1915**  
Lower Ball Joint  
(Ø14.9)

**AU2113**  
Lower Control Arm Bush

**AU1916**  
Lower Ball Joint  
(Ø14.9)



**AU2019**  
Lower Control Arm

**AU2020**  
Lower Control Arm

**AU1513**  
Link Stabilizer  
L=105.5

**AU1513**  
Link Stabilizer  
L=105.5



**AU1514**  
Link Stabilizer  
L=105.5

**AU2114**  
Lower Control Arm Bush

**AU1514**  
Link Stabilizer  
L=105.5



**AU1515**  
Link Stabilizer  
L=335

**AU2810**  
Stabilizer Bar Bush

**AU1516**  
Link Stabilizer  
L=335



**AU2814**  
Shock Mounting

**AU2814**  
Shock Mounting



**LEFT**

**RIGHT**

**AUDI**

**A3**

**REAR**

**ALL**

*Year*

**1998-2002**

**AU1517**

*Link Stabilizer*

*L=175*



**AU2913**

*Bush*

*(ID: Ø12.2/OD: Ø50)*



**AU2912**

*Bush*

*(ID: Ø12.2/OD: Ø71.5)*



**AU2815**

*Shock Mounting*



**AU2815**

*Shock Mounting*



**LEFT**

**RIGHT**



**AUDI**

**A3**

**FRONT**

**ALL**

*Year*

**2003-2013**

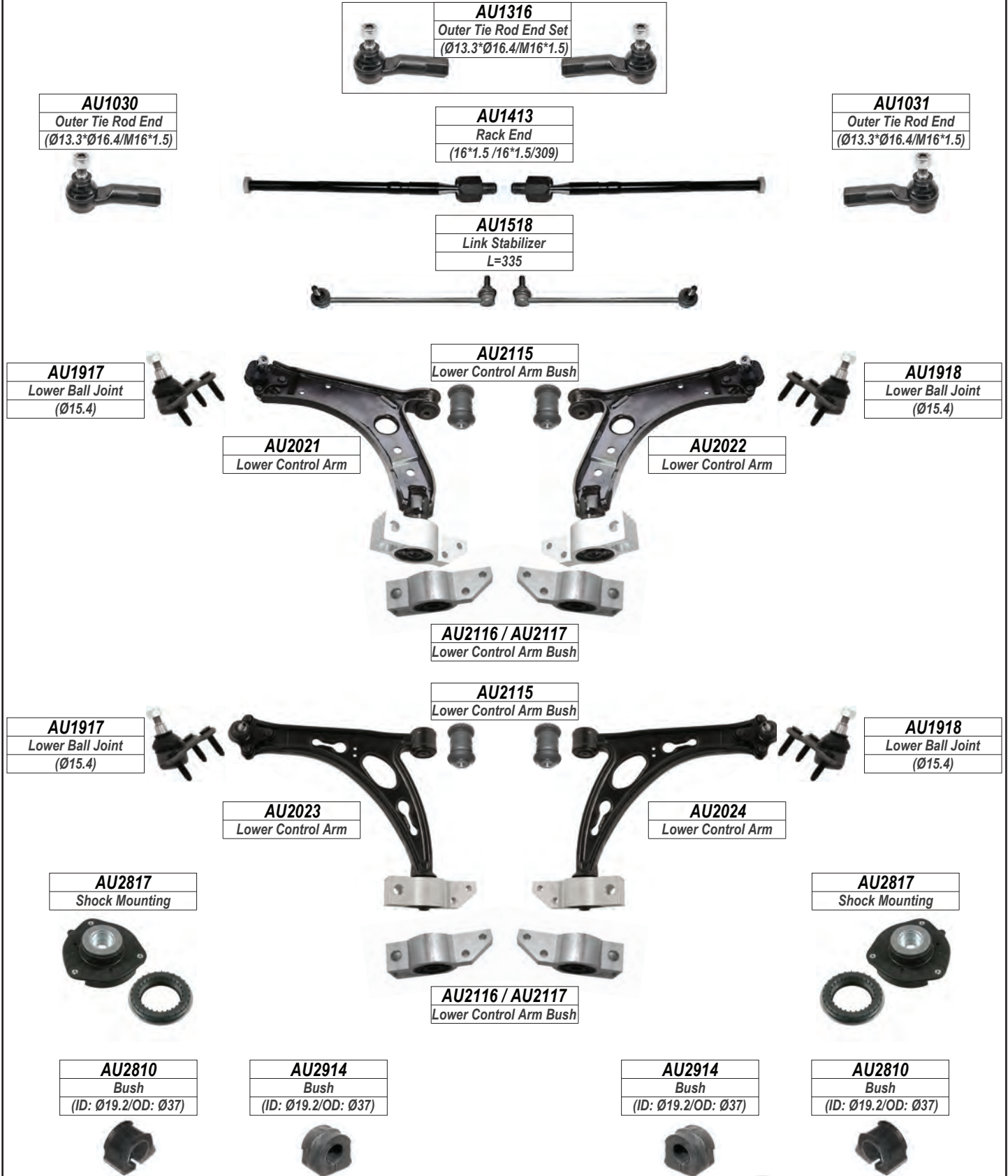

**LEFT**

**RIGHT**

**AUDI**

**A3**

**REAR**

**ALL**

*Year*

**2003-2013**

**AU1519**  
Link Stabilizer  
L=95.5



**AU2915**  
Bush  
(ID: Ø14.3/OD: Ø24.3)



**VW2911**  
Bush



**AU2610**  
Lateral Link



**AU2610**  
Lateral Link

**VW2911**  
Bush



**AU1710**  
Upper Control Arm



**AU2080 / AU2081**  
Lower Control Arm

**VW2114**  
Lower Control Arm Bush



**VW2014**  
Lower Control Arm

**VW2014**  
Lower Control Arm

**AU2818**  
Shock Mounting



**AU2818**  
Shock Mounting



**LEFT**

**RIGHT**

**AUDI**

**A3**

**FRONT**

**ALL**

*Year*

**2012-**

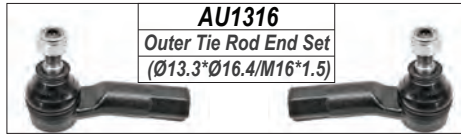

**AU1316**  
Outer Tie Rod End Set  
(Ø13.3\*Ø16.4/M16\*1.5)

**AU1030**  
Outer Tie Rod End  
(Ø13.3\*Ø16.4/M16\*1.5)

**AU1413**  
Rack End  
(16\*1.5 /16\*1.5/309)

**AU1031**  
Outer Tie Rod End  
(Ø13.3\*Ø16.4/M16\*1.5)



**AU1520**  
Link Stabilizer  
L=335



**AU2115**  
Lower Control Arm Bush

**AU1917**  
Lower Ball Joint  
(Ø15.4)



**AU1918**  
Lower Ball Joint  
(Ø15.4)

**AU2027**  
Lower Control Arm

**AU2028**  
Lower Control Arm

**AU2826**  
Shock Mounting



**AU2118**  
Lower Control Arm Bush

**AU2826**  
Shock Mounting

**AU2826**  
Shock Mounting



**A3**

**REAR**

**AU1512**  
Link Stabilizer  
L=70.2

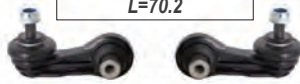

**AU2611**  
Lateral Link



**AU2818**  
Shock Mounting



**AU2818**  
Shock Mounting



**LEFT**

**RIGHT**

**AUDI**

A4

FRONT

8D2.8E5.B5.8D5.D2

Year

1994-2001



**AU1317**  
Outer Tie Rod End Set  
(Ø13.6\*Ø14.8/M14\*1.5)

**AU1022**  
Outer Tie Rod End  
(Ø13.6\*Ø14.8/M14\*1.5)



**AU1414**  
Rack End  
(16\*1.5 /14\*1.5/128)



**AU1022**  
Outer Tie Rod End  
(Ø13.6\*Ø14.8/M14\*1.5)



**AU1523**  
Link Stabilizer  
L=86



**AU1810**  
Upper Control Arm Bush



**AU1523**  
Link Stabilizer  
L=86



**AU1711**  
Upper Control Arm



**AU1712**  
Upper Control Arm

**AU1521**  
Link Stabilizer  
L=90



**AU1810**  
Upper Control Arm Bush



**AU1522**  
Link Stabilizer  
L=90



**AU1713**  
Upper Control Arm



**AU1714**  
Upper Control Arm



**AU2120**  
Lower Control Arm Bush

**AU2121**  
Lower Control Arm Bush

**AU2120**  
Lower Control Arm Bush

**AU2029**  
Lower Control Arm

**AU2029**  
Lower Control Arm



**AU2119**  
Lower Control Arm Bush

**AU2030**  
Lower Control Arm

**AU2031**  
Lower Control Arm

**AU2819**  
Shock Mounting



**AU2819**  
Shock Mounting



A4

REAR

**AU2619 / AU2620**  
Lateral Link



**AU2621**  
Lateral Link



LEFT

RIGHT



**AUDI**

**A4**

**FRONT**

**8E2.B6.8E5**

*Year*

**2001-2008**



**AU1317**  
Outer Tie Rod End Set  
(Ø13.6\*Ø14.8/M14\*1.5)

**AU1022**  
Outer Tie Rod End  
(Ø13.6\*Ø14.8/M14\*1.5)



**AU1414**  
Rack End  
(16\*1.5 /14\*1.5/128)



**AU1022**  
Outer Tie Rod End  
(Ø13.6\*Ø14.8/M14\*1.5)



**AU1523**  
Link Stabilizer  
L=86



**AU1524**  
Link Stabilizer  
L=90



**AU1525**  
Link Stabilizer  
L=90



**AU1523**  
Link Stabilizer  
L=86



**AU1810**  
Upper Control Arm Bush



**AU1711**  
Upper Control Arm

**AU1712**  
Upper Control Arm

**AU1810**  
Upper Control Arm Bush



**AU1713**  
Upper Control Arm

**AU1714**  
Upper Control Arm

**AU2121**  
Lower Control Arm Bush



**AU2122**  
Lower Control Arm Bush  
(ID:Ø12.4/OD:40.2/L=37)

**AU2032**  
Lower Control Arm  
(Ø16.3)

**AU2032**  
Lower Control Arm  
(Ø16.3)

**AU2122**  
Lower Control Arm Bush  
(ID:Ø12.4/OD:40.2/L=37)

**AU2121**  
Lower Control Arm Bush



**AU2120**  
Lower Control Arm Bush  
(ID:Ø12.2/OD:40.2/L=50)

**AU2033**  
Lower Control Arm  
(Ø16.3)

**AU2033**  
Lower Control Arm  
(Ø16.3)

**AU2120**  
Lower Control Arm Bush  
(ID:Ø12.2/OD:40.2/L=50)

**LEFT**

**RIGHT**

**AUDI**

A4

FRONT

8E2.B6.8E5

Year

2001-2008



**AU2820**  
Shock Mounting



**AU2820**  
Shock Mounting



A4

REAR



**AU2821**  
Shock Mounting



**AU2821**  
Shock Mounting



LEFT

RIGHT

**AUDI**

**A4**

**FRONT**

**8K2.B8.8K5**

*Year*

**2008-2016**

**AU1318**

Outer Tie Rod End Set  
(Ø14.7\*Ø19/M16\*1.5)



**AU1023**

Outer Tie Rod End  
(Ø14.7\*Ø19/M16\*1.5)



**AU1415**

Rack End  
(16\*1.5 /16\*1.5/227)



**AU1024**

Outer Tie Rod End  
(Ø14.7\*Ø19/M16\*1.5)



**AU1527**

Link Stabilizer  
L=170



**AU1528**

Link Stabilizer  
L=170



**AU1810**

Upper Control Arm Bush



**AU1715**

Upper Control Arm



**AU1716**

Upper Control Arm



**AU1811**

Upper Control Arm Bush



**AU1717**

Upper Control Arm



**AU1718**

Upper Control Arm



**AU1919**

Lower Ball Joint  
(Ø13.8)(2008-2011)



**AU2125**

Lower Control Arm Bush



**AU2124**

Lower Control Arm Bush



**AU2125**

Lower Control Arm Bush



**AU1919**

Lower Ball Joint  
(Ø13.8)(2008-2011)



**AU2037**

Lower Control Arm  
(Ø13.8)(2008-2011)



**AU2038**

Lower Control Arm  
(Ø13.8)(2008-2011)



**AU1920**

Lower Ball Joint  
(Ø17.3)(2011-)



**AU2125**

Lower Control Arm Bush



**AU2126**

Lower Control Arm Bush



**AU2125**

Lower Control Arm Bush



**AU1920**

Lower Ball Joint  
(Ø17.3)(2011-)



**AU2039**

Lower Control Arm  
(Ø17)(2011-)

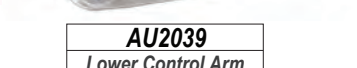

**AU2040**

Lower Control Arm  
(Ø17)(2011-)



**LEFT**

**RIGHT**

**AUDI**

**A4**

**FRONT**

**8K2.B8.8K5**

*Year*

**2008-2016**

**AU2127**  
Lower Control Arm Bush  
(OD:Ø65)



**AU2041**  
Lower Control Arm  
(Ø15)

**AU2127**  
Lower Control Arm Bush  
(OD:Ø65)

**AU2042**  
Lower Control Arm  
(Ø15)



**AU2043**  
Lower Control Arm  
(Ø17)

**AU2128**  
Lower Control Arm Bush  
(OD:Ø75)

**AU2044**  
Lower Control Arm  
(Ø17)



**AU2045**  
Lower Control Arm  
(Ø17)

**AU2046**  
Lower Control Arm  
(Ø17)

**AU2822**  
Shock Mounting



**AU2822**  
Shock Mounting



**A4**

**REAR**

**AU1529**  
Link Stabilizer  
L=90



**AU2623 / AU2624**  
Lateral Link



**AU2047**  
Lower Control Arm

**AU2048**  
Lower Control Arm

**LEFT**

**RIGHT**



**AUDI**

A4

FRONT

8WH.B9

Year

2016-

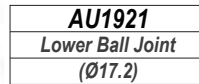
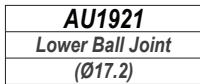
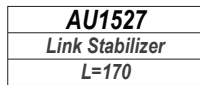
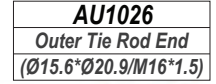
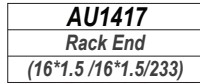
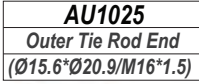
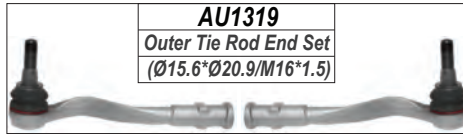

**LEFT**

**RIGHT**

**AUDI**

**A5**

**FRONT**

**8T3.8F7**

*Year*

**2008-2017**

**AU1318**

Outer Tie Rod End Set  
(Ø14.7\*Ø19/M16\*1.5)

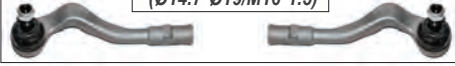

**AU1023**

Outer Tie Rod End  
(Ø14.7\*Ø19/M16\*1.5)



**AU1415**

Rack End  
(16\*1.5 /16\*1.5/227)



**AU1024**

Outer Tie Rod End  
(Ø14.7\*Ø19/M16\*1.5)



**AU1416**

Rack End  
(16\*1.5 /16\*1.5/235)



**AU1530**

Link Stabilizer  
L=110



**AU1528**

Link Stabilizer  
L=170



**AU1530**

Link Stabilizer  
L=110



**AU1527**

Link Stabilizer  
L=170



**AU1527**

Link Stabilizer  
L=170



**AU1810**

Upper Control Arm Bush



**AU1715**

Upper Control Arm



**AU1716**

Upper Control Arm



**AU1811**

Upper Control Arm Bush



**AU1717**

Upper Control Arm



**AU1718**

Upper Control Arm



**AU1919**

Lower Ball Joint  
(Ø13.8)(2008-2011)



**AU2125**

Lower Control Arm Bush



**AU2124**

Lower Control Arm Bush



**AU2125**

Lower Control Arm Bush



**AU1919**

Lower Ball Joint  
(Ø13.8)(2008-2011)



**AU2037**

Lower Control Arm  
(Ø13.8)(2008-2011)

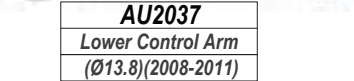

**AU2038**

Lower Control Arm  
(Ø13.8)(2008-2011)

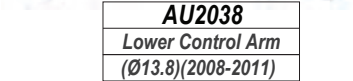

**AU1920**

Lower Ball Joint  
(Ø17.3)(2011-)



**AU2125**

Lower Control Arm Bush



**AU2126**

Lower Control Arm Bush



**AU2125**

Lower Control Arm Bush



**AU1920**

Lower Ball Joint  
(Ø17.3)(2011-)



**AU2039**

Lower Control Arm  
(Ø17)(2011-)

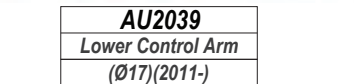

**AU2040**

Lower Control Arm  
(Ø17)(2011-)

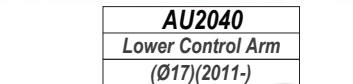

**LEFT**

**RIGHT**

**AUDI**

A5

FRONT

8T3.8F7

Year

2008-2017

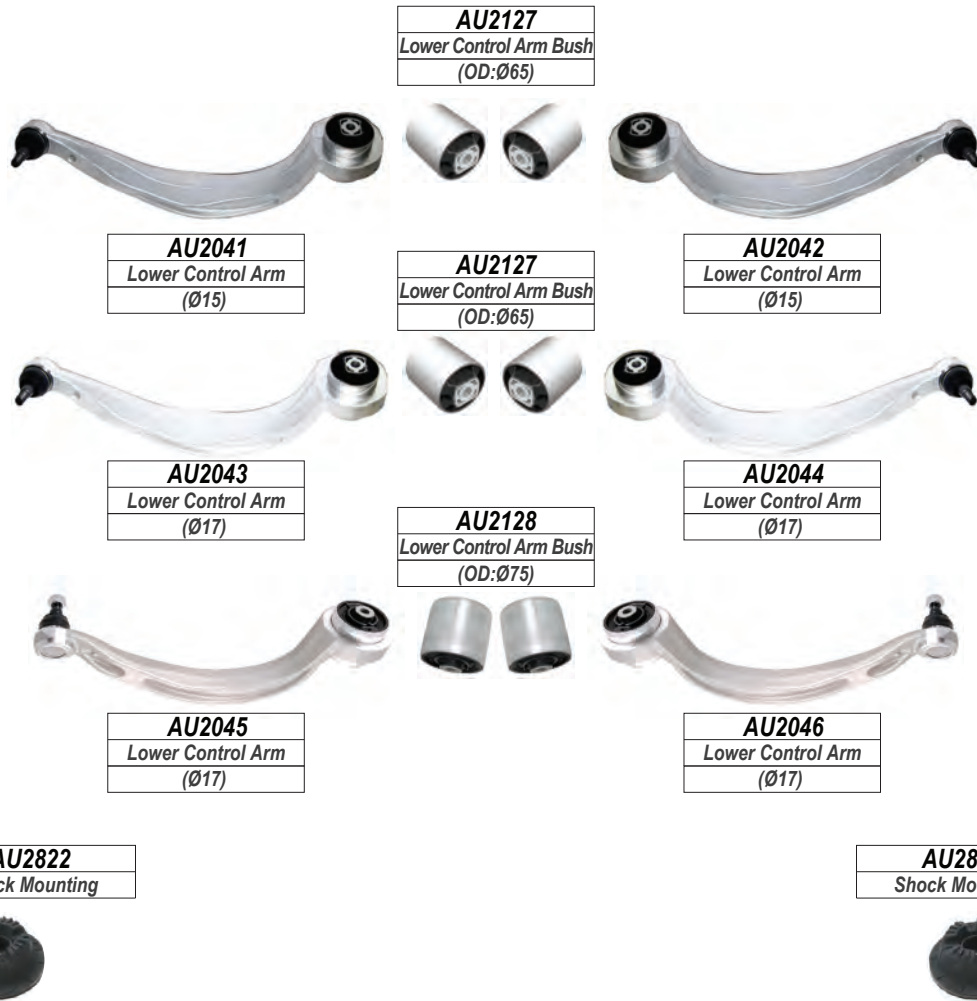

A5

REAR

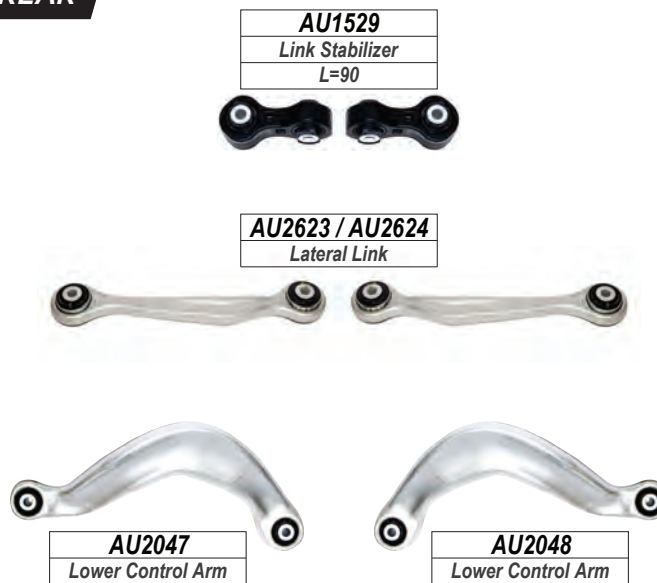

LEFT

RIGHT

**AUDI**

**A5**

**FRONT**

**F5A**

*Year*

**2017-**

**AU1319**

*Outer Tie Rod End Set*  
(Ø15.6\*Ø20.9/M16\*1.5)

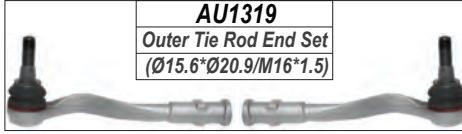

**AU1025**

*Outer Tie Rod End*  
(Ø15.6\*Ø20.9/M16\*1.5)



**AU1417**

*Rack End*  
(16\*1.5 /16\*1.5/233)



**AU1026**

*Outer Tie Rod End*  
(Ø15.6\*Ø20.9/M16\*1.5)



**AU1527**

*Link Stabilizer*  
L=170



**AU1921**

*Lower Ball Joint*  
(Ø17.2)



**AU1921**

*Lower Ball Joint*  
(Ø17.2)



**AU2051**

*Lower Control Arm*



**AU2052**

*Lower Control Arm*



**AU2049**

*Lower Control Arm*



**AU2050**

*Lower Control Arm*



**LEFT**

**RIGHT**



**AUDI**

**A6**

**FRONT**

*Year*

**1994-1997**

**ALL**

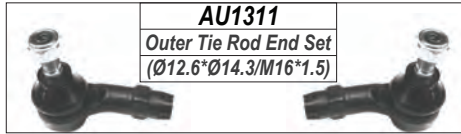

**AU1012**  
Outer Tie Rod End  
(Ø12.6\*Ø14.3/M16\*1.5)



**AU1013**  
Outer Tie Rod End  
(Ø12.6\*Ø14.3/M16\*1.5)



**AU1212 / AU1213**  
Tie Rod Assembly



**AU2310 / AU2311**  
Drag Link



**AU2112**  
Lower Control Arm Bush



**AU2129**  
Lower Control Arm Bush



**AU2014**  
Lower Control Arm

**AU2015**  
Lower Control Arm

**AU2129**  
Lower Control Arm Bush



**AU2823**  
Shock Mounting



**AU2911**  
Bush  
(ID: Ø12.1/OD: Ø63)



**AU2823**  
Shock Mounting



**A6**

**REAR**

**AU1510**  
Link Stabilizer  
L=122.5



**LEFT**

**RIGHT**

**AUDI**

A6

FRONT

ALL

Year

1997-2000



**AU1317**  
Outer Tie Rod End Set  
(Ø13.6\*Ø14.8/M14\*1.5)

**AU1022**  
Outer Tie Rod End  
(Ø13.6\*Ø14.8/M14\*1.5)



**AU1414**  
Rack End  
(16\*1.5 /14\*1.5/128)



**AU1022**  
Outer Tie Rod End  
(Ø13.6\*Ø14.8/M14\*1.5)



**AU1523**  
Link Stabilizer  
L=86



**AU1810**  
Upper Control Arm Bush



**AU1523**  
Link Stabilizer  
L=86



**AU1521**  
Link Stabilizer  
L=90



**AU1711**  
Upper Control Arm



**AU1712**  
Upper Control Arm

**AU1522**  
Link Stabilizer  
L=90



**AU1810**  
Upper Control Arm Bush



**AU1713**  
Upper Control Arm



**AU2121**  
Lower Control Arm Bush

**AU2120**  
Lower Control Arm Bush

**AU2120**  
Lower Control Arm Bush

**AU2029**  
Lower Control Arm



**AU2119**  
Lower Control Arm Bush

**AU2030**  
Lower Control Arm

**AU2031**  
Lower Control Arm

**AU2819**  
Shock Mounting



**AU2819**  
Shock Mounting



A6

REAR

**AU2824**  
Shock Mounting



**AU2824**  
Shock Mounting



LEFT

RIGHT

**AUDI**

A6

FRONT

ALL

Year

2001-2005



**AU1022**  
Outer Tie Rod End  
(Ø13.6\*Ø14.8/M14\*1.5)



**AU1414**  
Rack End  
(16\*1.5 /14\*1.5/128)



**AU1022**  
Outer Tie Rod End  
(Ø13.6\*Ø14.8/M14\*1.5)



**AU1521**  
Link Stabilizer  
L=90



**AU1810**  
Upper Control Arm Bush



**AU1522**  
Link Stabilizer  
L=90



**AU1711**  
Upper Control Arm



**AU1810**  
Upper Control Arm Bush



**AU1712**  
Upper Control Arm



**AU1713**  
Upper Control Arm



**AU1714**  
Upper Control Arm



**AU2120**  
Lower Control Arm Bush  
(ID:Ø12.2/OD:40.2/L=50)



**AU2121**  
Lower Control Arm Bush



**AU2120**  
Lower Control Arm Bush  
(ID:Ø12.2/OD:40.2/L=50)

**AU2029**  
Lower Control Arm  
(Ø20.6)



**AU2029**  
Lower Control Arm  
(Ø20.6)



**AU2122**  
Lower Control Arm Bush  
(ID:Ø12.4/OD:40.2/L=37)



**AU2121**  
Lower Control Arm Bush



**AU2122**  
Lower Control Arm Bush  
(ID:Ø12.4/OD:40.2/L=37)

**AU2032**  
Lower Control Arm  
(Ø16.3)



**AU2032**  
Lower Control Arm  
(Ø16.3)



**AU2119**  
Lower Control Arm Bush



**AU2030**  
Lower Control Arm



**AU2031**  
Lower Control Arm



A6

REAR

**AU2824**  
Shock Mounting



**AU1531**  
Link Stabilizer  
L=57.4



**AU2824**  
Shock Mounting



LEFT

RIGHT

**AUDI**

**A6**

**FRONT**

**ALL**

*Year*

**2005-2011**

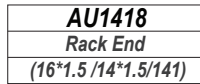
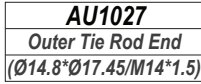

**A6**

**REAR**

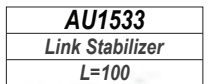
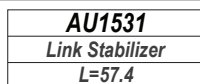

**LEFT**

**RIGHT**



**AUDI**

**A6**

**FRONT**

**ALL**

*Year*

**2011-**

**AU1318**

Outer Tie Rod End Set  
(Ø14.7\*Ø19/M16\*1.5)

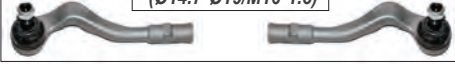

**AU1023**

Outer Tie Rod End  
(Ø14.7\*Ø19/M16\*1.5)



**AU1415**

Rack End  
(16\*1.5 /16\*1.5/227)



**AU1416**

Rack End  
(16\*1.5 /16\*1.5/235)



**AU1024**

Outer Tie Rod End  
(Ø14.7\*Ø19/M16\*1.5)



**AU1530**

Link Stabilizer  
L=110



**AU1528**

Link Stabilizer  
L=170



**AU1530**

Link Stabilizer  
L=110



**AU1527**

Link Stabilizer  
L=170



**AU1810**

Upper Control Arm Bush



**AU1715**

Upper Control Arm



**AU1716**

Upper Control Arm



**AU1811**

Upper Control Arm Bush



**AU1717**

Upper Control Arm



**AU1718**

Upper Control Arm



**AU1919**

Lower Ball Joint  
(Ø13.8)



**AU2125**

Lower Control Arm Bush



**AU2124**

Lower Control Arm Bush



**AU2125**

Lower Control Arm Bush



**AU1919**

Lower Ball Joint  
(Ø13.8)



**AU2037**

Lower Control Arm  
(Ø13.8)



**AU2038**

Lower Control Arm  
(Ø13.8)



**AU1920**

Lower Ball Joint  
(Ø17.3)



**AU2125**

Lower Control Arm Bush



**AU2126**

Lower Control Arm Bush



**AU2125**

Lower Control Arm Bush



**AU1920**

Lower Ball Joint  
(Ø17.3)



**AU2039**

Lower Control Arm  
(Ø17)



**AU2040**

Lower Control Arm  
(Ø17)



**LEFT**

**RIGHT**

**AUDI**

**A6**

**FRONT**

**ALL**

*Year*

**2011-**

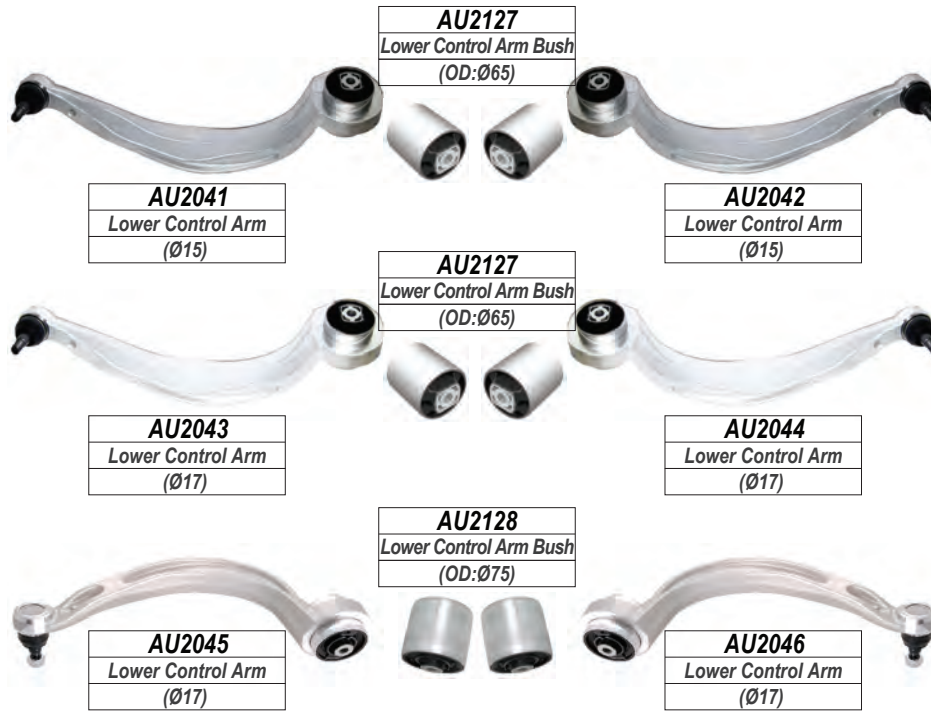

**AU2820**  
Shock Mounting



**AU2820**  
Shock Mounting



**A6**

**REAR**

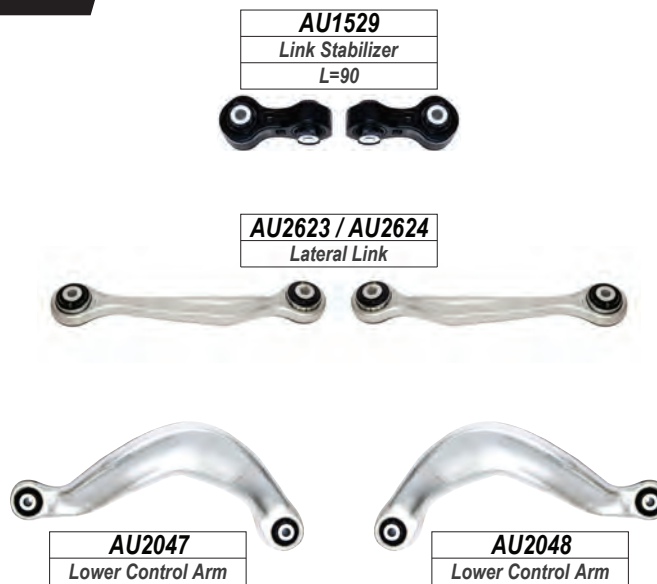

**LEFT**

**RIGHT**

**AUDI**

**A7 SPORTBACK FRONT**

**4GA**

*Year*

**2010-**

**AU1318**

Outer Tie Rod End Set  
(Ø14.7\*Ø19/M16\*1.5)

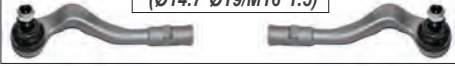

**AU1023**

Outer Tie Rod End  
(Ø14.7\*Ø19/M16\*1.5)



**AU1416**

Rack End  
(16\*1.5 /16\*1.5/235)



**AU1024**

Outer Tie Rod End  
(Ø14.7\*Ø19/M16\*1.5)



**AU1528**

Link Stabilizer  
L=170



**AU1810**

Upper Control Arm Bush



**AU1715**

Upper Control Arm

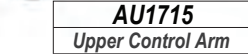

**AU1716**

Upper Control Arm



**AU1811**

Upper Control Arm Bush



**AU1717**

Upper Control Arm

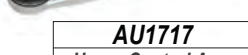

**AU1718**

Upper Control Arm

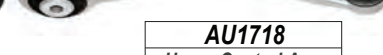

**AU1919**

Lower Ball Joint  
(Ø13.8)



**AU2125**

Lower Control Arm Bush



**AU2124**

Lower Control Arm Bush



**AU2125**

Lower Control Arm Bush



**AU1919**

Lower Ball Joint  
(Ø13.8)



**AU2037**

Lower Control Arm  
(Ø13.8)

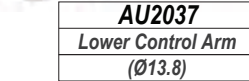

**AU2038**

Lower Control Arm  
(Ø13.8)

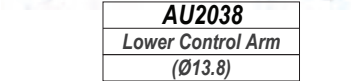

**AU1920**

Lower Ball Joint  
(Ø17.3)



**AU2125**

Lower Control Arm Bush



**AU2126**

Lower Control Arm Bush



**AU2125**

Lower Control Arm Bush



**AU1920**

Lower Ball Joint  
(Ø17.3)



**AU2039**

Lower Control Arm  
(Ø17)

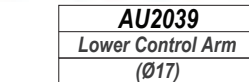

**AU2040**

Lower Control Arm  
(Ø17)

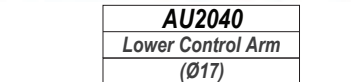

**LEFT**

**RIGHT**

**AUDI**

**A7 SPORTBACK FRONT**

**4GA**

*Year*

**2010-**

**AU2127**  
Lower Control Arm Bush  
(OD:Ø65)



**AU2041**  
Lower Control Arm  
(Ø15)

**AU2127**  
Lower Control Arm Bush  
(OD:Ø65)

**AU2042**  
Lower Control Arm  
(Ø15)



**AU2043**  
Lower Control Arm  
(Ø17)

**AU2128**  
Lower Control Arm Bush  
(OD:Ø75)

**AU2044**  
Lower Control Arm  
(Ø17)



**AU2045**  
Lower Control Arm  
(Ø17)

**AU2046**  
Lower Control Arm  
(Ø17)

**AU2820**  
Shock Mounting



**AU2820**  
Shock Mounting



**A7 SPORTBACK**

**REAR**

**AU1534**  
Lateral Link



**AU2058**  
Lower Control Arm

**AU2059**  
Lower Control Arm

**LEFT**

**RIGHT**

**AUDI**

**A8**

**FRONT**

**ALL**

*Year*

**1994-2001**

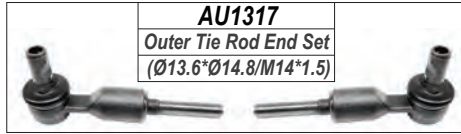

**AU1317**  
Outer Tie Rod End Set  
(Ø13.6\*Ø14.8/M14\*1.5)

**AU1022**  
Outer Tie Rod End  
(Ø13.6\*Ø14.8/M14\*1.5)



**AU1414**  
Rack End  
(16\*1.5 /14\*1.5/128)



**AU1022**  
Outer Tie Rod End  
(Ø13.6\*Ø14.8/M14\*1.5)



**AU1523**  
Link Stabilizer  
L=86



**AU1810**  
Upper Control Arm Bush



**AU1523**  
Link Stabilizer  
L=86



**AU1711**  
Upper Control Arm



**AU1712**  
Upper Control Arm

**AU1532**  
Link Stabilizer  
L=110



**AU1810**  
Upper Control Arm Bush



**AU1532**  
Link Stabilizer  
L=110



**AU1713**  
Upper Control Arm



**AU1714**  
Upper Control Arm

**AU2121**  
Lower Control Arm Bush



**AU2120**  
Lower Control Arm Bush  
(ID:Ø12.2/OD:40.2/L=50)

**AU2029**  
Lower Control Arm  
(Ø20.6)



**AU2029**  
Lower Control Arm  
(Ø20.6)

**AU2120**  
Lower Control Arm Bush  
(ID:Ø12.2/OD:40.2/L=50)



**AU2121**  
Lower Control Arm Bush



**AU2120**  
Lower Control Arm Bush  
(ID:Ø12.2/OD:40.2/L=50)

**AU2033**  
Lower Control Arm  
(Ø16.3)



**AU2033**  
Lower Control Arm  
(Ø16.3)

**AU2120**  
Lower Control Arm Bush  
(ID:Ø12.2/OD:40.2/L=50)



**AU2121**  
Lower Control Arm Bush



**AU2120**  
Lower Control Arm Bush  
(ID:Ø12.2/OD:40.2/L=50)

**AU2034**  
Lower Control Arm  
(Ø20.6)(ALLROAD only)



**AU2034**  
Lower Control Arm  
(Ø20.6)(ALLROAD only)

**AU2120**  
Lower Control Arm Bush  
(ID:Ø12.2/OD:40.2/L=50)



**LEFT**

**RIGHT**



**AUDI**

**A8**

**FRONT**

**ALL**

*Year*

**1994-2001**



**AU2819**  
Shock Mounting



**AU2819**  
Shock Mounting



**A8**

**REAR**



**AU1536 / AU1537**  
Link Stabilizer  
L=62



**AU1538**  
Link Stabilizer  
L=95



**AU2625**  
Lateral Link



**AU2626**  
Lateral Link



**LEFT**

**RIGHT**

**AUDI**

A8

FRONT

ALL

Year

2002-2009

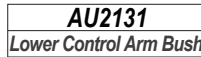
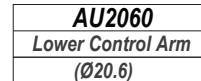
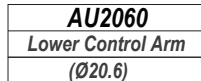
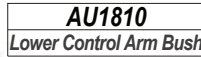
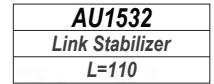
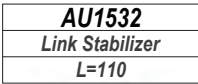
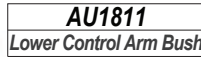
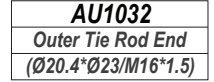
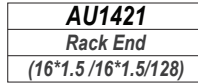
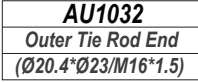
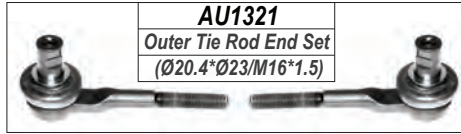

A8

REAR

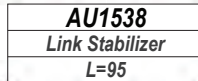

LEFT

RIGHT

**AUDI**

**A8**

**FRONT**

**ALL**

*Year*

**2009-**

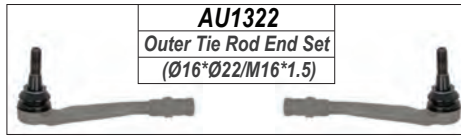

**AU1322**  
Outer Tie Rod End Set  
(Ø16\*Ø22/M16\*1.5)

**AU1033**  
Outer Tie Rod End  
(Ø16\*Ø22/M16\*1.5)



**AU1416**  
Rack End  
(16\*1.5 /14\*1.5/128)



**AU1034**  
Outer Tie Rod End  
(Ø16\*Ø22/M16\*1.5)



**AU1539**  
Link Stabilizer  
L=170



**AU1812**  
Upper Control Arm Bush



**AU1723**  
Upper Control Arm



**AU1724**  
Upper Control Arm



**AU1812**  
Upper Control Arm Bush



**AU1725**  
Upper Control Arm



**AU1726**  
Upper Control Arm



**AU1922**  
Lower Ball Joint  
(Ø18)



**AU2132**  
Lower Control Arm Bush



**AU1922**  
Lower Ball Joint  
(Ø18)



**AU2063**  
Lower Control Arm



**AU2064**  
Lower Control Arm



**AU2128**  
Lower Control Arm Bush



**AU2065**  
Lower Control Arm  
(Ø19)

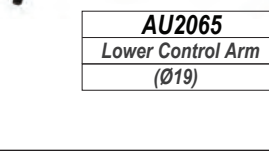

**AU2066**  
Lower Control Arm  
(Ø19)

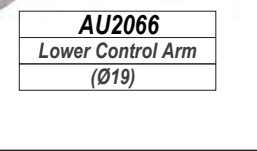

**A8**

**REAR**

**AU2614 / AU2615**  
Lateral Link



**LEFT**

**RIGHT**

**AUDI**

**COUPE QUATTRO FRONT**

Year

**CABRIOLET**

**1982-2000**

**AU1216 / AU1217**  
Tie Rod Assembly



**AU1924**

Lower Ball Joint  
(Ø19)



**AU2133**

Lower Control Arm Bush



**AU1925**

Lower Ball Joint  
(Ø19)



**AU2067**

Lower Control Arm



**AU2068**

Lower Control Arm

**AU1923**

Lower Ball Joint  
(Ø19)



**AU1923**

Lower Ball Joint  
(Ø19)



**AU2910**

Bush

(ID: M8\*1.25/OD: Ø30)



**LEFT**

**RIGHT**

**AUDI**

**Q3**

**FRONT**

**ALL**

**Year**

**2011-**

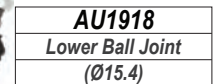
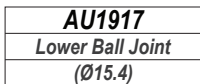
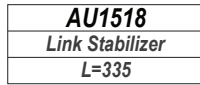
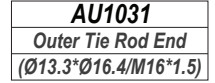
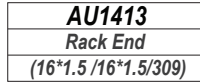
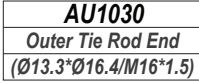
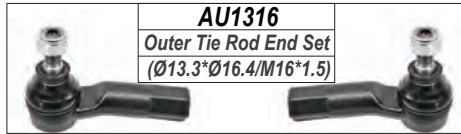

**Q3**

**REAR**

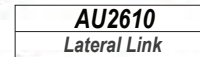
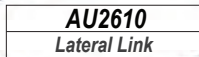
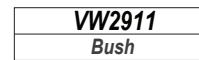
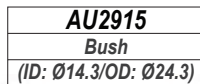

**LEFT**

**RIGHT**



**AUDI**

**Q5**

**FRONT**

**ALL**

**Year**

**2008-**

**AU1318**

Outer Tie Rod End Set  
(Ø14.7\*Ø19/M16\*1.5)

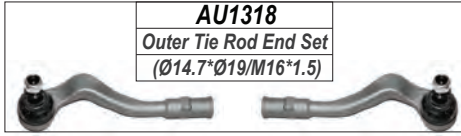

**AU1023**

Outer Tie Rod End  
(Ø14.7\*Ø19/M16\*1.5)



**AU1415**

Rack End  
(16\*1.5/16\*1.5/227)



**AU1024**

Outer Tie Rod End  
(Ø14.7\*Ø19/M16\*1.5)



**AU1527**

Link Stabilizer  
L=170



**AU1528**

Link Stabilizer  
L=170



**AU1810**

Upper Control Arm Bush



**AU1715**

Upper Control Arm  
Alt:AU1727



**AU1716**

Upper Control Arm  
Alt:AU1728



**AU1811**

Upper Control Arm Bush



**AU1717**

Upper Control Arm  
Alt:AU1729

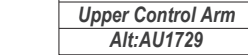

**AU1718**

Upper Control Arm  
Alt:AU1730



**AU1919**

Lower Ball Joint  
(Ø13.8)



**AU2125**

Lower Control Arm Bush



**AU2124**

Lower Control Arm Bush



**AU2125**

Lower Control Arm Bush



**AU1919**

Lower Ball Joint  
(Ø13.8)



**AU2037**

Lower Control Arm  
(Ø13.8)

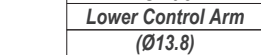

**AU2038**

Lower Control Arm  
(Ø13.8)

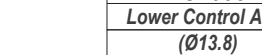

**AU1920**

Lower Ball Joint  
(Ø17.3)



**AU2125**

Lower Control Arm Bush



**AU2126**

Lower Control Arm Bush



**AU2125**

Lower Control Arm Bush



**AU1920**

Lower Ball Joint  
(Ø17.3)



**AU2039**

Lower Control Arm  
(Ø17)

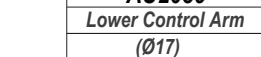

**AU2040**

Lower Control Arm  
(Ø17)

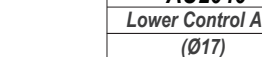

**LEFT**

**RIGHT**

**AUDI**

**Q5**

**FRONT**

**ALL**

*Year*

**2008-**

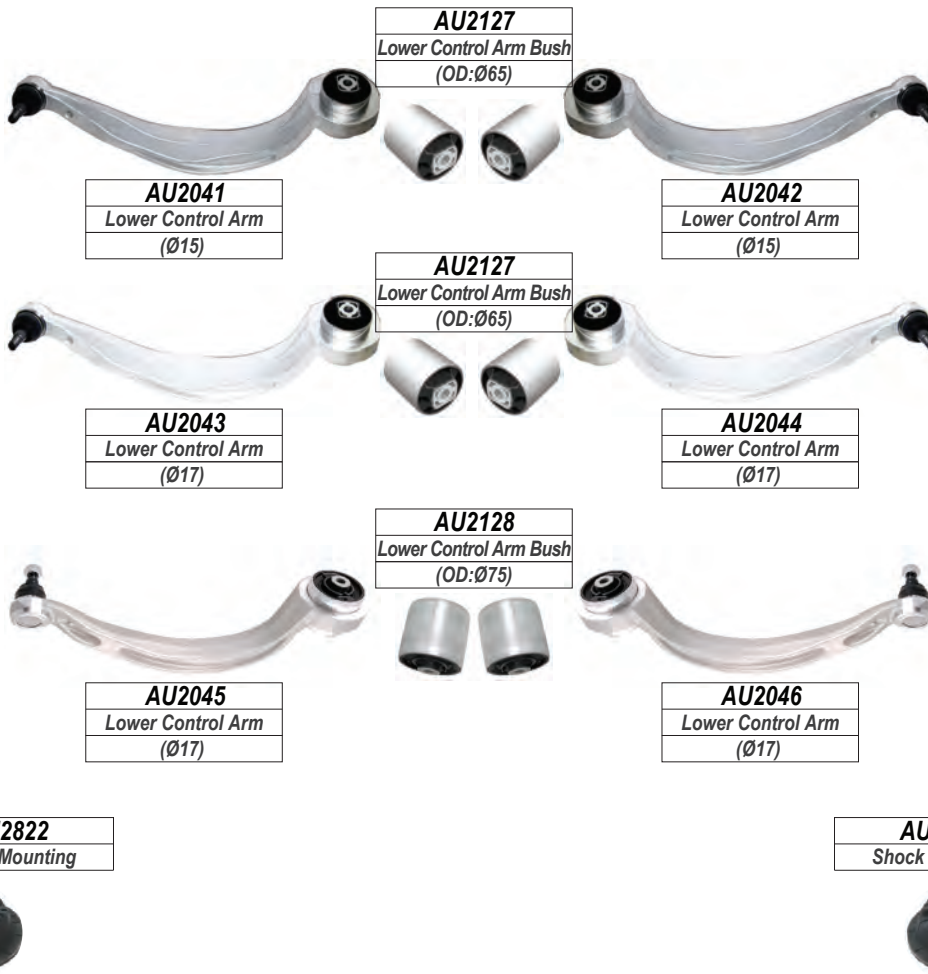

**Q5**

**REAR**



**LEFT**

**RIGHT**

**AUDI**

**Q7**

**FRONT**

**ALL**

**Year**

**2006-**

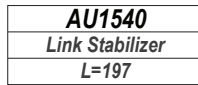
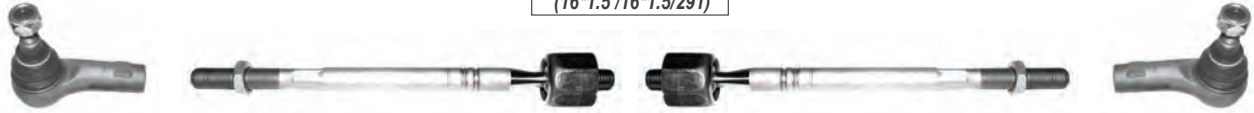
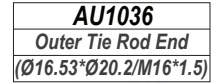
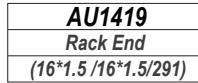
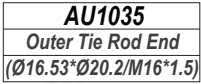
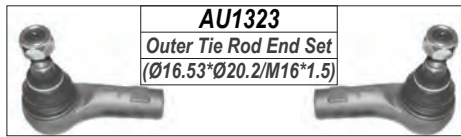

**LEFT**

**RIGHT**

**AUDI**

**Q7**

**REAR**

**ALL**

*Year*

**2006-**

**AU1541 / AU1542**  
Link Stabilizer  
L=201



**AU1543 / AU1544**  
Link Stabilizer  
L=200



**AU2811**  
Bush  
(ID:12.2/OD:Ø40)

**AU2813**  
Bush  
(ID:12.2/OD:Ø40)



**AU2813**  
Bush  
(ID:12.2/OD:Ø40)

**AU2616**  
Lateral Link

**AU2616**  
Lateral Link

**AU2812**  
Bush  
(ID:16.2/OD:Ø44.3)

**AU2813**  
Bush  
(ID:12.2/OD:Ø40)



**AU2813**  
Bush  
(ID:12.2/OD:Ø40)

**AU2617**  
Lateral Link

**AU2618**  
Lateral Link

**LEFT**

**RIGHT**

**AUDI**

**S3**

**FRONT**

**1.8.1.8T**

*Year*

**1998-2003**

**AU1324**

Outer Tie Rod End Set  
(Ø13.3\*Ø15.5/M16\*1.5)

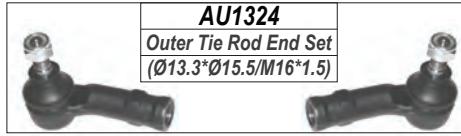

**AU1037**

Outer Tie Rod End  
(Ø13.3\*Ø15.5/M16\*1.5)



**AU1420**

Rack End  
(16\*1.5 /16\*1.5/332)



**AU1038**

Outer Tie Rod End  
(Ø13.3\*Ø15.5/M16\*1.5)



**AU1545 / AU1546**

Link Stabilizer  
L=340

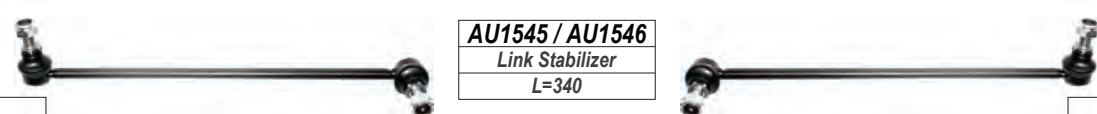

**AU1926**

Lower Ball Joint  
(Ø15.4)



**AU2139**

Lower Control Arm Bush



**AU1926**

Lower Ball Joint  
(Ø15.4)



**AU2076**

Lower Control Arm



**AU2077**

Lower Control Arm



**AU2814**

Shock Mounting



**AU2814**

Shock Mounting



**AU2114**

Lower Control Arm Bush

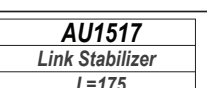

**S3**

**REAR**

**AU1517**

Link Stabilizer  
L=175



**VW2910**

Bush

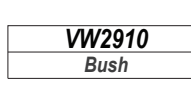

**VW2910**

Bush

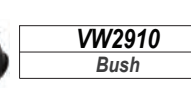

**VW2610**

Lateral Link



**VW2610**

Lateral Link



**VW2611**

Lateral Link



**VW2611**

Lateral Link



**AU2913**

Bush

(ID: Ø12.2/OD: Ø50)



**AU2815**

Shock Mounting



**AU2815**

Shock Mounting



**AU2912**

Bush

(ID: Ø12.2/OD: Ø71.5)



**LEFT**

**RIGHT**



**AUDI**

**S3**

**FRONT**

**1.8T QUATTRO**

*Year*

**2003-2008**

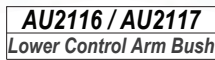
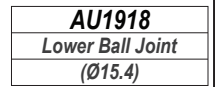
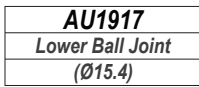
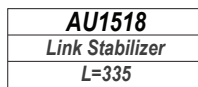
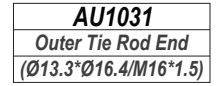
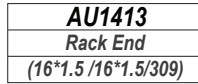
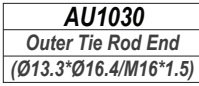
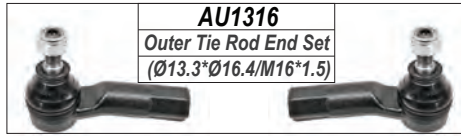

**LEFT**

**RIGHT**

**AUDI**

**TT**

**FRONT**

**8N3.8N9**

*Year*

**2000-2006**

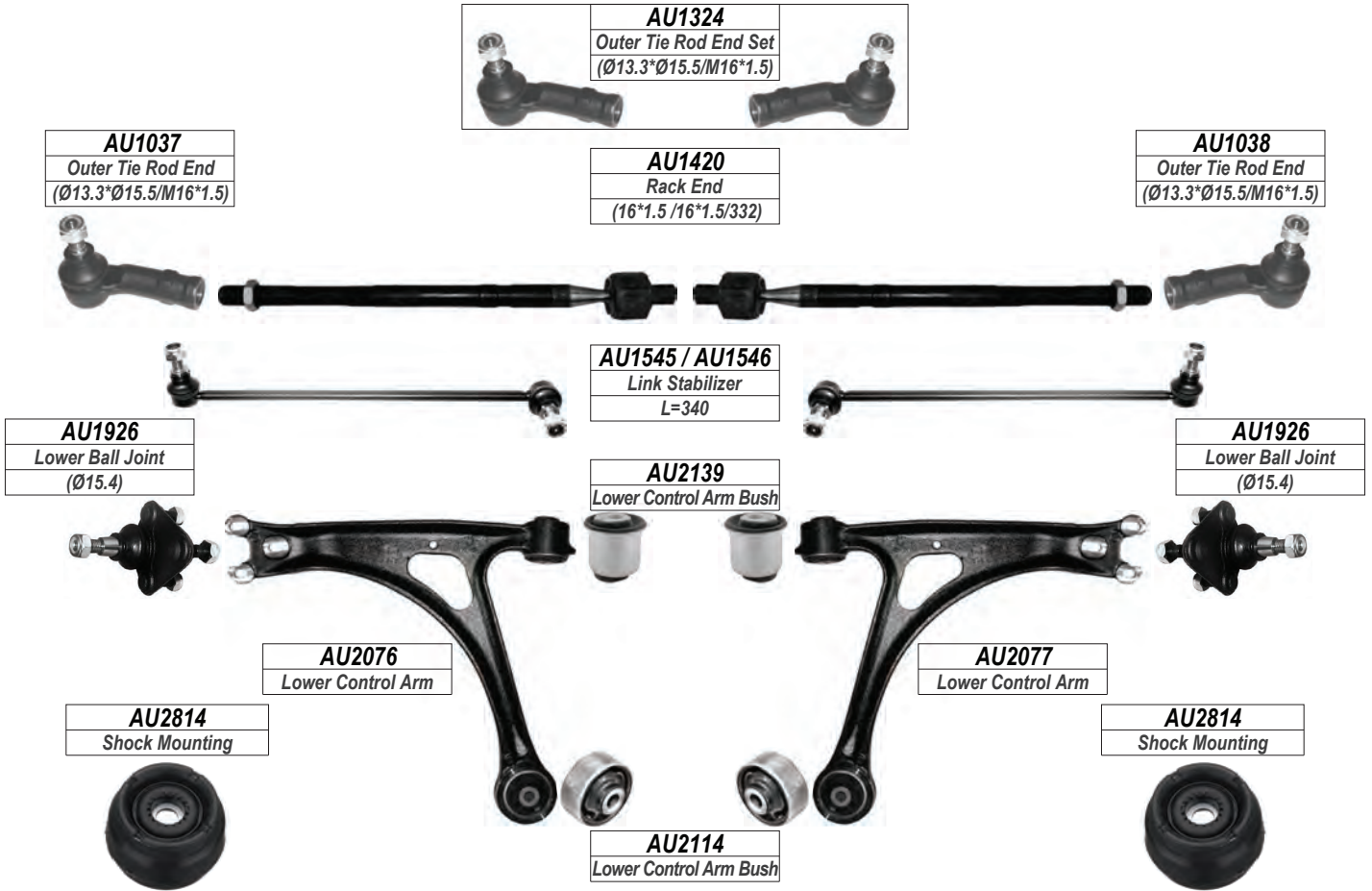

**TT**

**REAR**



**LEFT**

**RIGHT**

**AUDI**

TT

FRONT

8J3.8J9 ROADSTER

Year

2006-

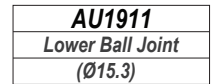
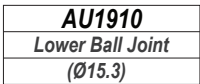
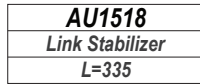
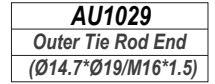
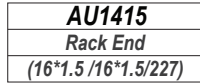
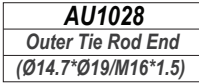
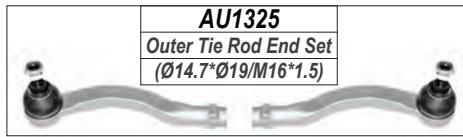

TT

REAR

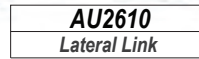
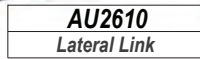
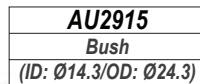
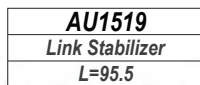

LEFT

RIGHT

**BMW**

**1 SERIES**

**FRONT**

**E81.E87.E87.E88**

**Year**

**2004-2010**

**BM1013**  
Outer Tie Rod End  
(Ø15.7/M14\*1.5)

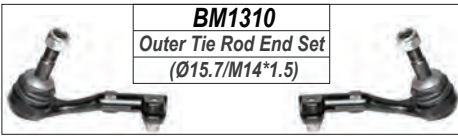

**BM1310**  
Outer Tie Rod End Set  
(Ø15.7/M14\*1.5)

**BM1410**  
Rack End  
(18\*1.5 /14\*1.5/245)

**BM1014**  
Outer Tie Rod End  
(Ø15.7/M14\*1.5)

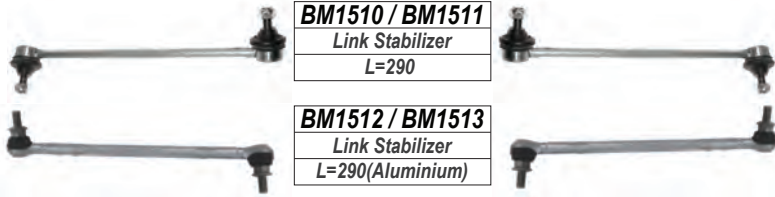

**BM1510 / BM1511**  
Link Stabilizer  
L=290

**BM1512 / BM1513**  
Link Stabilizer  
L=290(Aluminium)

**BM1810**  
Upper Control Arm Bush



**BM1710**  
Upper Control Arm

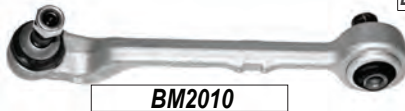

**BM2110**  
Lower Control Arm Bush



**BM1711**  
Upper Control Arm



**BM2010**  
Lower Control Arm



**BM2011**  
Lower Control Arm



**BM2813**  
Shock Mounting



**BM2813**  
Shock Mounting



**1 SERIES**

**REAR**

**BM1514**  
Link Stabilizer  
L=160



**BM2910**  
Bush



**BM2910**  
Bush



**BM2611**  
Lateral Link



**BM2611**  
Lateral Link



**BM2910**  
Bush



**BM2913**  
Bush



**BM2612**  
Lateral Link  
L=273



**BM2612**  
Lateral Link  
L=273



**BM2913**  
Bush



**BM2913**  
Bush



**BM2613**  
Lateral Link  
L=240



**BM2613**  
Lateral Link  
L=240



**BM2913**  
Bush





**BMW**

**1 SERIES**

**FRONT**

**F20. F21**

**Year**

**2011-**

**BM1017**  
Outer Tie Rod End  
(Ø16.2/M14\*1.5)

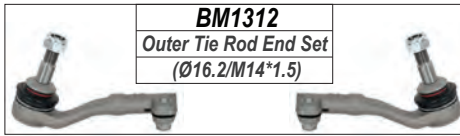

**BM1312**  
Outer Tie Rod End Set  
(Ø16.2/M14\*1.5)

**BM1423**  
Rack End  
(16\*1.5 /14\*1.5/253)

**BM1018**  
Outer Tie Rod End  
(Ø16.2/M14\*1.5)



**BM1515 / BM1516**  
Link Stabilizer  
L=311



**BM1569 / BM1570**  
Link Stabilizer  
L=311



**BM1811**  
Upper Control Arm Bush



**BM1712**  
Upper Control Arm



**BM1713**  
Upper Control Arm



**BM2012**  
Lower Control Arm

**BM2111**  
Lower Control Arm Bush



**BM2013**  
Lower Control Arm

**BM2814**  
Shock Mounting



**BM2814**  
Shock Mounting



**1 SERIES**

**REAR**

**BM1517 / BM1518**  
Link Stabilizer  
L=135



**BM2914**  
Bush



**BM2614**  
Lateral Link  
L=329.4



**BM2614**  
Lateral Link  
L=329.4

**LEFT**

**RIGHT**

**BMW**

**2 SERIES**

**FRONT**

**F22**

**Year**

**2013-**

**BM1017**  
Outer Tie Rod End  
(Ø16.2/M14\*1.5)



**BM1312**  
Outer Tie Rod End Set  
(Ø16.2/M14\*1.5)

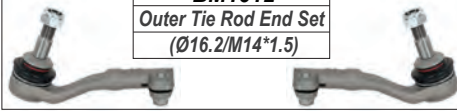

**BM1423**  
Rack End  
(16\*1.5 / 14\*1.5/253)



**BM1018**  
Outer Tie Rod End  
(Ø16.2/M14\*1.5)



**BM1515 / BM1516**  
Link Stabilizer  
L=311



**BM1569 / BM1570**  
Link Stabilizer  
L=311



**BM1811**  
Upper Control Arm Bush



**BM1712**  
Upper Control Arm



**BM1713**  
Upper Control Arm



**BM2111**  
Lower Control Arm Bush



**BM2012**  
Lower Control Arm



**BM2013**  
Lower Control Arm



**BM2814**  
Shock Mounting



**BM2814**  
Shock Mounting



**2 SERIES**

**REAR**

**BM1517 / BM1518**  
Link Stabilizer  
L=135



**BM2914**  
Bush



**BM2614**  
Lateral Link  
L=329.4



**BM2614**  
Lateral Link  
L=329.4



**LEFT**

**RIGHT**

**BMW**

**2 SERIES**

**FRONT**

**F45**

**Year**

**2015-**

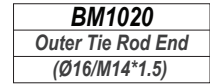
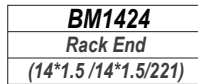
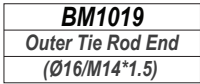
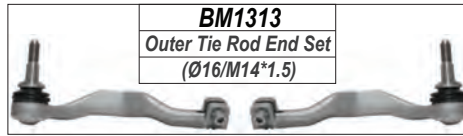

**LEFT**

**RIGHT**

**BMW**

**3 SERIES**

**FRONT**

**E30**

Year

1982-1993

**BM1314**  
Outer Tie Rod End Set  
(Ø12.6\*Ø14.2/M14\*1.5)



**BM1021**  
Outer Tie Rod End  
(Ø12.6\*Ø14.2/M14\*1.5)



**BM1425**  
Rack End  
(18\*1.5/14\*1.5/232)



**BM1021**  
Outer Tie Rod End  
(Ø12.6\*Ø14.2/M14\*1.5)



**BM1411**  
Rack End  
(18\*1.5/14\*1.5/232)



**BM1520**  
Link Stabilizer  
L=66.5

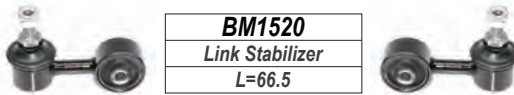

**BM1521**  
Link Stabilizer  
L=239



**BM1911**  
Lower Ball Joint  
(Ø14.9)

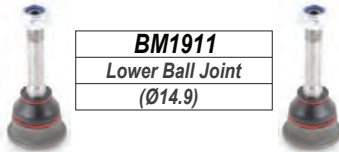

**BM1910**  
Lower Ball Joint  
(Ø14.5)



**BM1910**  
Lower Ball Joint  
(Ø14.5)



**BM2016**  
Lower Control Arm



**BM2017**  
Lower Control Arm



**BM2815**  
Shock Mounting



**BM2815**  
Shock Mounting



**BM2115**  
Lower Control Arm Bush



**BM2114**  
Lower Control Arm Bush



**BM2116**  
Lower Control Arm Bush



**2 SERIES**

**REAR**

**BM2915**  
Bush  
(ID: Ø12 OD:Ø35 L:70)

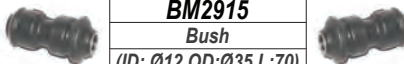

**BM1522**  
Link Stabilizer  
L=100

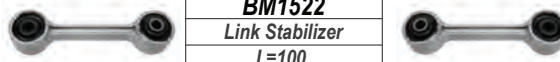

**BM2816**  
Shock Mounting



**BM2816**  
Shock Mounting



**BM2916**  
Bush  
(ID: Ø17 OD:Ø85 L:30)



LEFT

RIGHT

**BMW**

**3 SERIES**

**FRONT**

**E36.Z3**

*Year*

**1992-2000**

**BM1022**  
Outer Tie Rod End  
(Ø12.6\*Ø14.2/M14\*1.5)

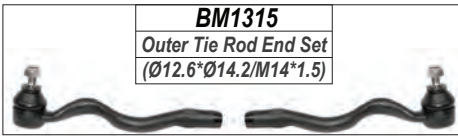

**BM1315**  
Outer Tie Rod End Set  
(Ø12.6\*Ø14.2/M14\*1.5)

**BM1412**  
Rack End  
(18\*1.5 /14\*1.5/205)



**BM1023**  
Outer Tie Rod End  
(Ø12.6\*Ø14.2/M14\*1.5)



**BM1413**  
Rack End  
(18\*1.5 /14\*1.5/205)



**BM1520**  
Link Stabilizer  
L=66.5

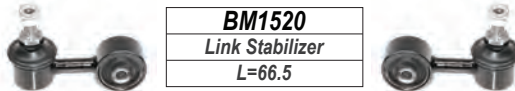

**BM1523**  
Link Stabilizer  
L=239

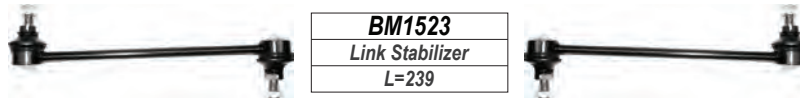

**BM1912**  
Lower Ball Joint  
(Ø14.4/L=17)



**BM1912**  
Lower Ball Joint  
(Ø14.4/L=17)



**BM1911**  
Lower Ball Joint  
(Ø14.9)



**BM1913**  
Lower Ball Joint  
(Ø14.4/L=20.6)



**BM1913**  
Lower Ball Joint  
(Ø14.4/L=20.6)



**BM2018**  
Lower Control Arm



**BM2019**  
Lower Control Arm



**BM2810**  
Stabilizer Bar Bush



**BM2115**  
Lower Control Arm Bush



**BM2116**  
Lower Control Arm Bush



**BM2810**  
Stabilizer Bar Bush



**BM2117**  
Lower Control Arm Bush



**BM2817**  
Shock Mounting



**BM2817**  
Shock Mounting



**LEFT**

**RIGHT**



**BMW**
**3 SERIES**
**REAR**
**E36.Z3**

Year

**1992-2000**

<b>BM2610</b>
Lateral Link
L=557



<b>BM2610</b>
Lateral Link
L=557



<b>BM1522</b>
Link Stabilizer
L=100



<b>BM2119</b>
Lower Control Arm Bush
(ID: Ø22.5 OD:Ø45.2)



<b>BM2118</b>
Lower Control Arm Bush
(ID: Ø23.8 OD:Ø35.5)



<b>BM2120</b>
Lower Control Arm Bush
(ID: Ø12.2 OD:Ø45.4)



<b>BM2917</b>
Bush
(ID: Ø12.5 OD:Ø46)



<b>BM2918</b>
Bush
(ID: Ø12.2 OD:Ø60.5)



<b>BM2919</b>
Bush
(ID: Ø24 OD:Ø43)



<b>BM2920</b>
Bush
(ID: Ø20.3 OD:Ø40.5)



<b>BM2921</b>
Bush
(ID: Ø23 OD:Ø46.4)



<b>BM2922</b>
Bush
(ID: Ø15.6 OD:Ø67.9)



<b>BM2816</b>
Shock Mounting



<b>BM2816</b>
Shock Mounting

**LEFT**
**RIGHT**

**BMW**

**3 SERIES**

**FRONT**

**E46.Z4**

**Year**

**1998-2005**

**BM1024**  
Outer Tie Rod End  
(Ø10/M14\*1.5)

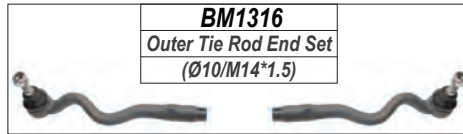

**BM1316**  
Outer Tie Rod End Set  
(Ø10/M14\*1.5)

**BM1414**  
Rack End  
(18\*1.5 /14\*1.5/206)



**BM1025**  
Outer Tie Rod End  
(Ø10/M14\*1.5)



**BM1524**  
Link Stabilizer  
L=271



**BM2020**  
Lower Control Arm

**BM2021**  
Lower Control Arm

**BM2121**  
Lower Control Arm Bush



**BM2122**  
Lower Control Arm Bush

**BM2123**  
Lower Control Arm Bush



**BM2713**  
Complete

**BM2714**  
Complete

**BM2813**  
Shock Mounting



**BM2813**  
Shock Mounting



**LEFT**

**RIGHT**

**BMW**

**3 SERIES**

**REAR**

**E46.Z4**

*Year*

**1998-2005**



**BM1525**  
Link Stabilizer  
L=95



**BM2119**  
Lower Control Arm Bush  
(ID: Ø22.5 OD:Ø45.2)



**BM2118**  
Lower Control Arm Bush  
(ID: Ø23.8 OD:Ø35.5)



**BM2120**  
Lower Control Arm Bush  
(ID: Ø12.2 OD:Ø45.4)



**BM2923**  
Bush  
(ID: Ø16.5 OD:Ø40)



**BM2919**  
Bush  
(ID: Ø24 OD:Ø43)



**BM2918**  
Bush  
(ID: Ø12.2 OD:Ø60.5)



**BM2938**  
(Rear Diff. Bush)  
(ID: Ø12.2 OD:Ø60.5)



**BM2816**  
Shock Mounting



**BM2816**  
Shock Mounting



**LEFT**

**RIGHT**

**BMW**

**3 SERIES**

**FRONT**

**E90.E91.E92.E93**

**Year**

**2005-2011**

**BM1013**  
Outer Tie Rod End  
(Ø15.7/M14\*1.5)

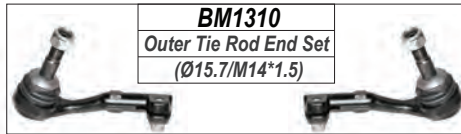

**BM1310**  
Outer Tie Rod End Set  
(Ø15.7/M14\*1.5)

**BM1410**  
Rack End  
(18\*1.5 /14\*1.5/245)

**BM1014**  
Outer Tie Rod End  
(Ø15.7/M14\*1.5)

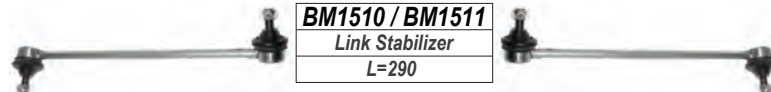

**BM1510 / BM1511**  
Link Stabilizer  
L=290

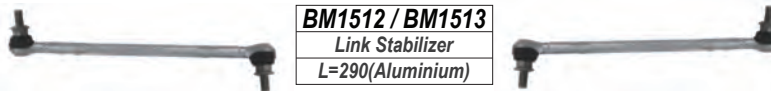

**BM1512 / BM1513**  
Link Stabilizer  
L=290(Aluminium)



**BM1810**  
Upper Control Arm Bush

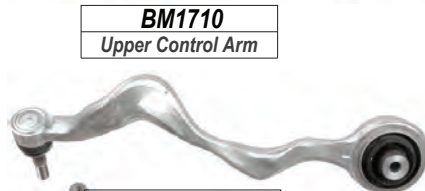

**BM1710**  
Upper Control Arm



**BM1711**  
Upper Control Arm



**BM1762**  
Upper Control Arm  
M3 Only



**BM1763**  
Upper Control Arm  
M3 Only



**BM2110**  
Lower Control Arm Bush



**BM2010**  
Lower Control Arm



**BM2011**  
Lower Control Arm



**BM2124**  
Lower Control Arm Bush



**BM2022**  
Lower Control Arm  
3.35i Only



**BM2022**  
Lower Control Arm  
3.35i Only



**BM2023**  
Lower Control Arm  
M3 Only



**BM2024**  
Lower Control Arm  
M3 Only



**BM2813**  
Shock Mounting



**BM2813**  
Shock Mounting

**LEFT**

**RIGHT**

**BMW**

**3 SERIES**

**REAR**

**E90.E91.E92.E93**

*Year*

**2005-2011**

**BM1514**

Link Stabilizer

L=160



**BM2910**

Bush

**BM2910**

Bush

**BM2910**

Bush



**BM2611**

Lateral Link

L=413.5

**BM2611**

Lateral Link

L=413.5

**BM2913**

Bush

**BM2911**

Bush

**BM2913**

Bush



**BM2612**

Lateral Link

L=273

**BM2612**

Lateral Link

L=273

**BM2912**

Bush

**BM2913**

Bush

**BM2913**

Bush



**BM2613**

Lateral Link

L=240

**BM2613**

Lateral Link

L=240

**BM2125**

Bush

(ID: Ø14.1 OD:Ø47.3)



**LEFT**

**RIGHT**



**BMW**

**3 SERIES**

**FRONT**

**F30.F31.F34.F35.F80**

**Year**

**2011-**

**BM1017**  
Outer Tie Rod End  
(Ø16.2/M14\*1.5)

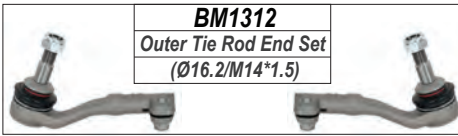

**BM1312**  
Outer Tie Rod End Set  
(Ø16.2/M14\*1.5)

**BM1423**  
Rack End  
(16\*1.5 /14\*1.5/253)

**BM1018**  
Outer Tie Rod End  
(Ø16.2/M14\*1.5)



**BM1515 / BM1516**  
Link Stabilizer  
L=311



**BM1569 / BM1570**  
Link Stabilizer  
L=311

**BM1811**  
Upper Control Arm Bush



**BM1712**  
Upper Control Arm

**BM1713**  
Upper Control Arm

**BM2111**  
Lower Control Arm Bush



**BM2012**  
Lower Control Arm

**BM2013**  
Lower Control Arm



**BM2025**  
Lower Control Arm  
M3 Only



**BM2026**  
Lower Control Arm  
M3 Only

**BM2814**  
Shock Mounting



**BM2814**  
Shock Mounting



**3 SERIES**

**REAR**

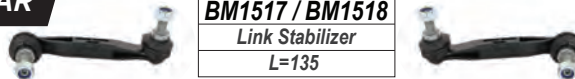

**BM1517 / BM1518**  
Link Stabilizer  
L=135

**BM2914**  
Bush



**BM2614**  
Lateral Link  
L=329.4

**BM2614**  
Lateral Link  
L=329.4

**LEFT**

**RIGHT**

**BMW**

**4 SERIES**

**FRONT**

**F32.F82.F83**

**Year**

**2013-**

**BM1017**  
Outer Tie Rod End  
(Ø16.2/M14\*1.5)

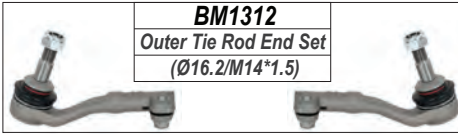

**BM1312**  
Outer Tie Rod End Set  
(Ø16.2/M14\*1.5)

**BM1423**  
Rack End  
(16\*1.5 /14\*1.5/253)

**BM1018**  
Outer Tie Rod End  
(Ø16.2/M14\*1.5)



**BM1515 / BM1516**  
Link Stabilizer  
L=311



**BM1569 / BM1570**  
Link Stabilizer  
L=311



**BM1811**  
Upper Control Arm Bush



**BM1712**  
Upper Control Arm



**BM1713**  
Upper Control Arm



**BM2111**  
Lower Control Arm Bush



**BM2012**  
Lower Control Arm



**BM2013**  
Lower Control Arm



**BM2025**  
Lower Control Arm  
M4 Only



**BM2026**  
Lower Control Arm  
M4 Only



**BM2814**  
Shock Mounting



**BM2814**  
Shock Mounting



**5 SERIES**

**REAR**



**BM1517 / BM1518**  
Link Stabilizer  
L=135



**BM2914**  
Bush



**BM2614**  
Lateral Link  
L=329.4



**BM2614**  
Lateral Link  
L=329.4

**LEFT**

**RIGHT**

**BMW**

**5 SERIES**

**FRONT**

**E28**

*Year*

**1985-1989**

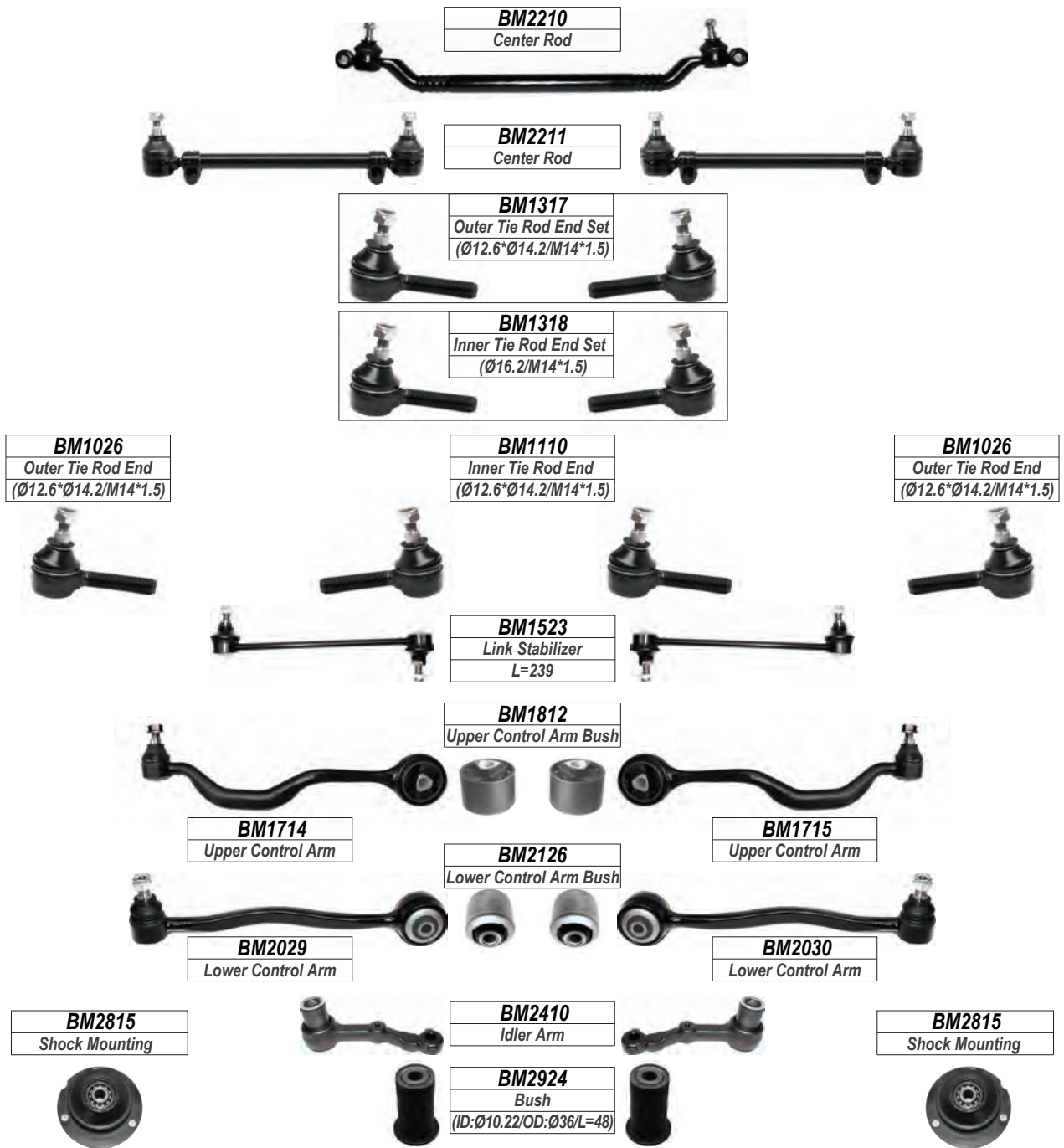

**5 SERIES**

**REAR**

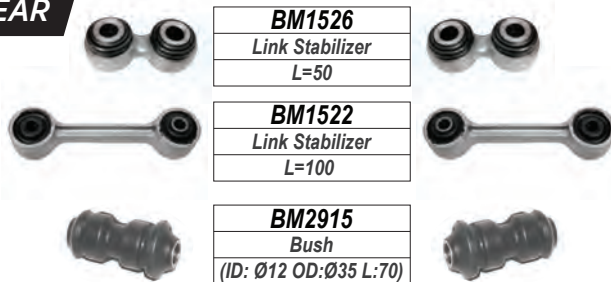

**LEFT**

**RIGHT**

**BMW**

**5 SERIES**

**FRONT**

**E34**

*Year*

**1989-1997**



**BM2212**  
Center Rod



**BM2213**  
Center Rod

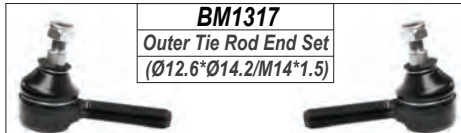

**BM1317**  
Outer Tie Rod End Set  
(Ø12.6\*Ø14.2/M14\*1.5)

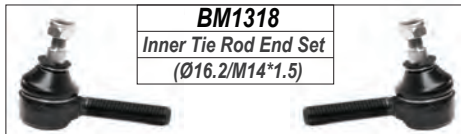

**BM1318**  
Inner Tie Rod End Set  
(Ø16.2/M14\*1.5)

**BM1026**  
Outer Tie Rod End  
(Ø12.6\*Ø14.2/M14\*1.5)



**BM1110**  
Inner Tie Rod End  
(Ø12.6\*Ø14.2/M14\*1.5)



**BM1110**  
Inner Tie Rod End  
(Ø12.6\*Ø14.2/M14\*1.5)



**BM1026**  
Outer Tie Rod End  
(Ø12.6\*Ø14.2/M14\*1.5)



**BM2211**  
Center Rod

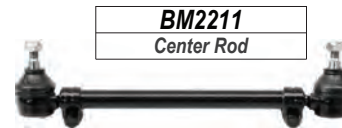

**BM2211**  
Center Rod



**BM1523**  
Link Stabilizer  
L=239

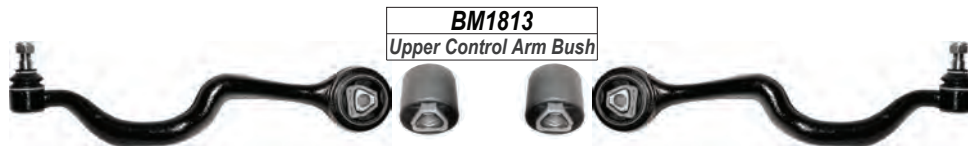

**BM1813**  
Upper Control Arm Bush

**BM1716**  
Upper Control Arm



**BM2126**  
Lower Control Arm Bush



**BM1717**  
Upper Control Arm

**BM2820**  
Shock Mounting



**BM2029**  
Lower Control Arm



**BM2410**  
Idler Arm



**BM2030**  
Lower Control Arm



**BM2820**  
Shock Mounting



**BM2818**  
Shock Mounting(2.5)



**BM2924**  
Bush  
(ID:Ø10.22/OD:Ø36/L=48)



**BM2818**  
Shock Mounting(2.5)



**BM2815**  
Shock Mounting(2.0)



**BM2810**  
Stabilizer Bar Bush



**BM2815**  
Shock Mounting(2.0)



**LEFT**

**RIGHT**

**BMW**

**5 SERIES**

**REAR**

**E34**

*Year*

**1989-1997**



**BM1526**  
Link Stabilizer  
L=50



**BM2915**  
Bush  
(ID: Ø12 OD:Ø35 L:70)



**BM2920**  
Bush  
(ID: Ø20.3 OD:Ø40.5)



**BM2926**  
Bush  
(ID:Ø15.8/OD:Ø51)



**LEFT**

**RIGHT**



**BMW**

**5 SERIES**

**FRONT**

**E39(523.525.528.530.530D)**

**Year**

**1996-2004**

**BM2214**

Center Rod



**BM1319**

Outer Tie Rod End Set  
(Ø12.75\*Ø16.4/M16\*1.0)



**BM1027**

Outer Tie Rod End  
(Ø12.75\*Ø16.4/M16\*1.0)



**BM1415**

Rack End  
(18\*1.5/16\*1.0/175)



**BM1028**

Outer Tie Rod End  
(Ø12.75\*Ø16.4/M16\*1.0)



**BM1527 / BM1528**

Link Stabilizer  
L=240



**BM1814**

Upper Control Arm Bush



**BM1718**

Upper Control Arm



**BM1719**

Upper Control Arm



**BM2127**

Lower Control Arm Bush



**BM2031**

Lower Control Arm



**BM2032**

Lower Control Arm



**BM2924**

Bush

(ID:Ø10.22/OD:Ø36/L=48)

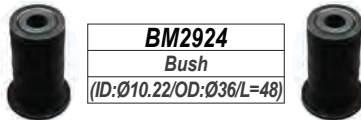

**BM2813**

Shock Mounting



**BM2813**

Shock Mounting



**LEFT**

**RIGHT**

**BMW**

**5 SERIES**

**REAR**

**E39(523.525.528.530.530D)**

**Year**

**1996-2004**



**BM1529**  
Link Stabilizer  
L=66



**BM1531**  
Link Stabilizer  
L=66



**BM1530**  
Link Stabilizer  
L=93.5



**BM1815**  
Upper Control Arm Bush



**BM1720**  
Upper Control Arm



**BM1721**  
Upper Control Arm

**BM2128**  
Lower Control Arm Bush



**BM2033**  
Lower Control Arm



**BM2033**  
Lower Control Arm



**BM2927**  
Bush



**BM2928**  
Bush



**LEFT**

**RIGHT**

**BMW**

**5 SERIES**

**FRONT**

**E39(540I.M5)**

**Year**

**1998-2004**

**BM1029**  
Outer Tie Rod End  
(Ø12.7\*Ø16.4/M16\*1.5)



**BM2214**  
Center Rod



**BM1320**  
Outer Tie Rod End Set  
(Ø12.7\*Ø16.4/M16\*1.5)



**BM1030**  
Outer Tie Rod End  
(Ø12.7\*Ø16.4/M16\*1.5)



**BM1532**  
Link Stabilizer  
L=285



**BM1816**  
Upper Control Arm Bush



**BM1722**  
Upper Control Arm



**BM1723**  
Upper Control Arm

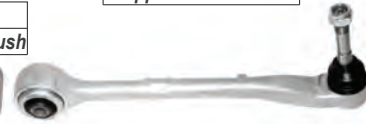

**BM2127**  
Lower Control Arm Bush



**BM2034**  
Lower Control Arm



**BM2035**  
Lower Control Arm



**BM2819**  
Shock Mounting



**BM2819**  
Shock Mounting



**5 SERIES**

**REAR**

**BM1529**  
Link Stabilizer  
L=66

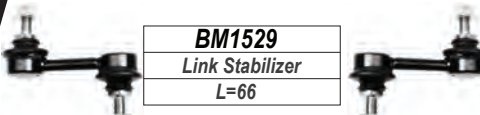

**BM1530**  
Link Stabilizer  
L=93.5

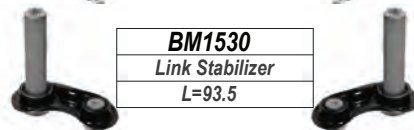

**BM1815**  
Upper Control Arm Bush



**BM1720**  
Upper Control Arm



**BM1721**  
Upper Control Arm



**BM2128**  
Lower Control Arm Bush



**BM2033**  
Lower Control Arm



**BM2033**  
Lower Control Arm

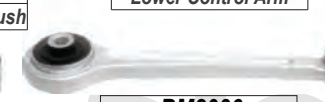

**BM2129**  
Lower Control Arm Bush



**BM2036**  
Lower Control Arm



**BM2036**  
Lower Control Arm



**LEFT**

**RIGHT**

**BMW**

**5 SERIES**

**FRONT**

**E60**

*Year*

**2003-2010**

**BM1031**  
Outer Tie Rod End  
(Ø16.2/M16\*1.5)

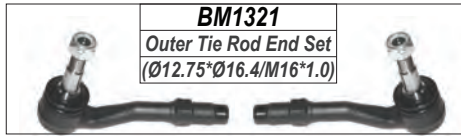

**BM1321**  
Outer Tie Rod End Set  
(Ø12.75\*Ø16.4/M16\*1.0)

**BM1031**  
Outer Tie Rod End  
(Ø16.2/M16\*1.5)



**BM1416**  
Rack End  
(18\*1.5 /16\*1.5/241)



**BM1533 / BM1534**  
Link Stabilizer  
L=300



**BM1817**  
Upper Control Arm Bush



**BM1724**  
Upper Control Arm



**BM1725**  
Upper Control Arm

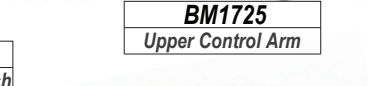

**BM2127**  
Lower Control Arm Bush



**BM2037**  
Lower Control Arm



**BM2038**  
Lower Control Arm



**BM2813**  
Shock Mounting



**BM2813**  
Shock Mounting



**5 SERIES**

**REAR**

**BM1818**  
Upper Control Arm Bush



**BM1726**  
Upper Control Arm

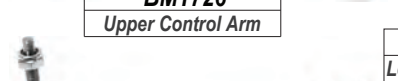

**BM1727**  
Upper Control Arm

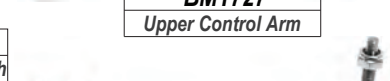

**BM2128**  
Lower Control Arm Bush



**BM2036**  
Lower Control Arm



**BM2036**  
Lower Control Arm



**BM1535**  
Link Stabilizer  
L=102



**BM1530**  
Link Stabilizer  
L=93.5



**BM2928**  
Bush

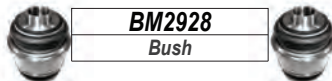

**LEFT**

**RIGHT**

**BMW**

**5 SERIES**

**FRONT**

**F10. F11. F18**

**Year**

**2010-**

**BM1010**  
Outer Tie Rod End  
(Ø16.4/M14\*1.5)

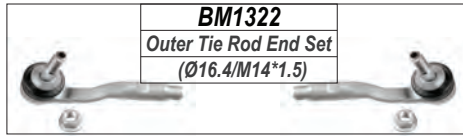

**BM1322**  
Outer Tie Rod End Set  
(Ø16.4/M14\*1.5)

**BM1426**  
Rack End  
(18\*1.5 /14\*1.5/245)

**BM1011**  
Outer Tie Rod End  
(Ø16.4/M14\*1.5)

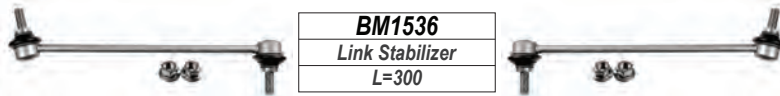

**BM1536**  
Link Stabilizer  
L=300

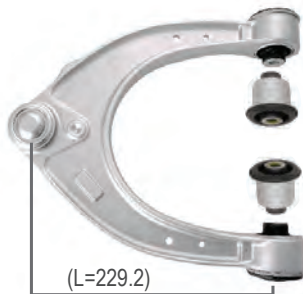

(L=229.2)

**BM1728**  
Upper Control Arm

**BM1819**  
Upper Control Arm Bush



**BM1728**  
Upper Control Arm

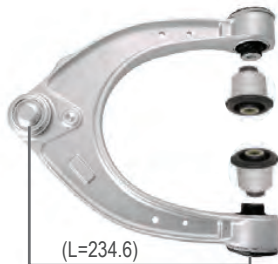

(L=234.6)

**BM1729**  
Upper Control Arm

**BM1819**  
Upper Control Arm Bush



**BM1729**  
Upper Control Arm



**BM2039**  
Lower Control Arm

**BM2130**  
Lower Control Arm Bush



**BM2040**  
Lower Control Arm

**LEFT**

**RIGHT**



**BMW**

**5 SERIES**

**REAR**

**F10. F11. F18**

**Year**

**2010-**

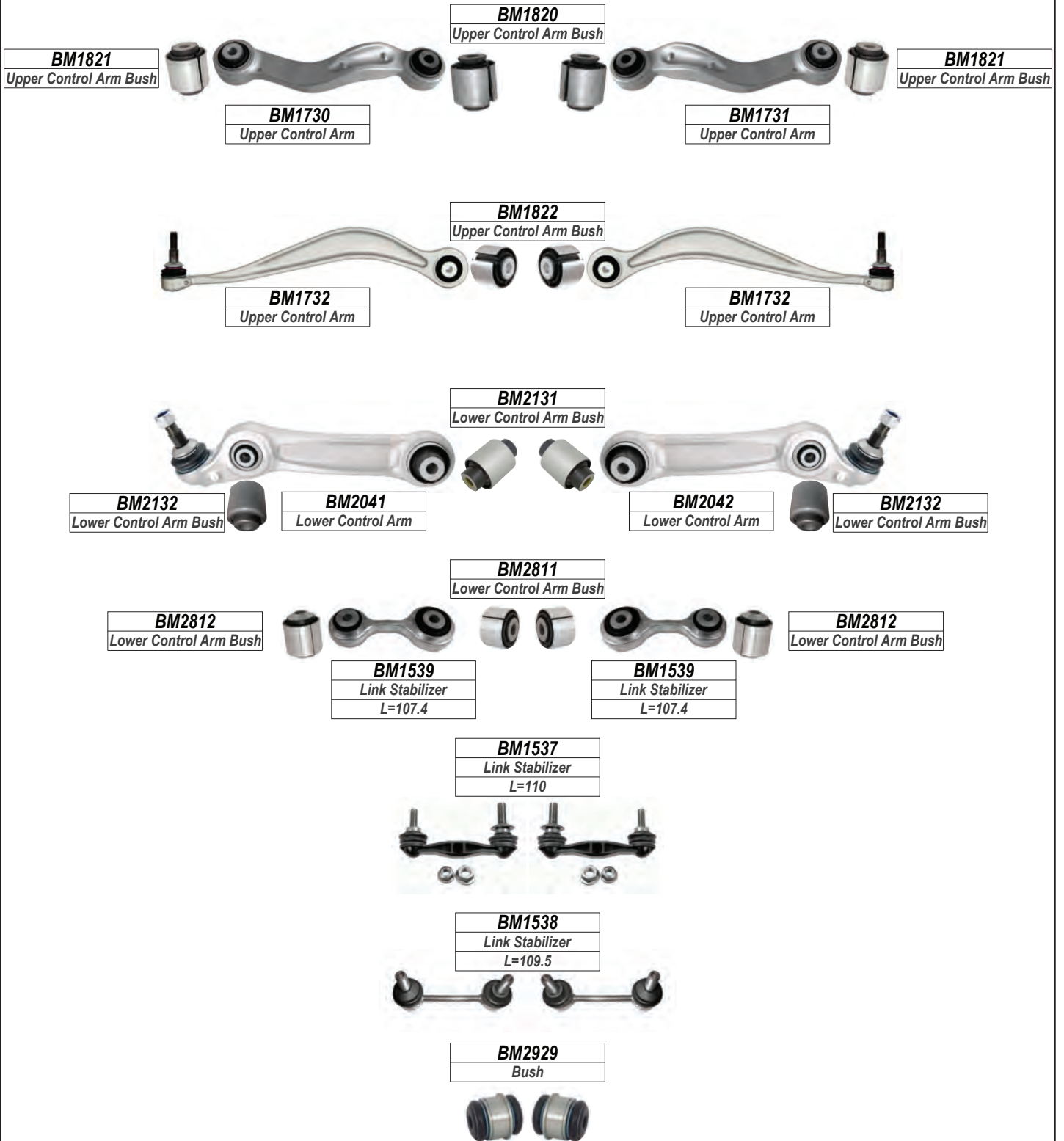

**LEFT**

**RIGHT**

**BMW**

**5 SERIES**

**FRONT**

**F07(GRAN TURISMO)**

**Year**

**2009-**

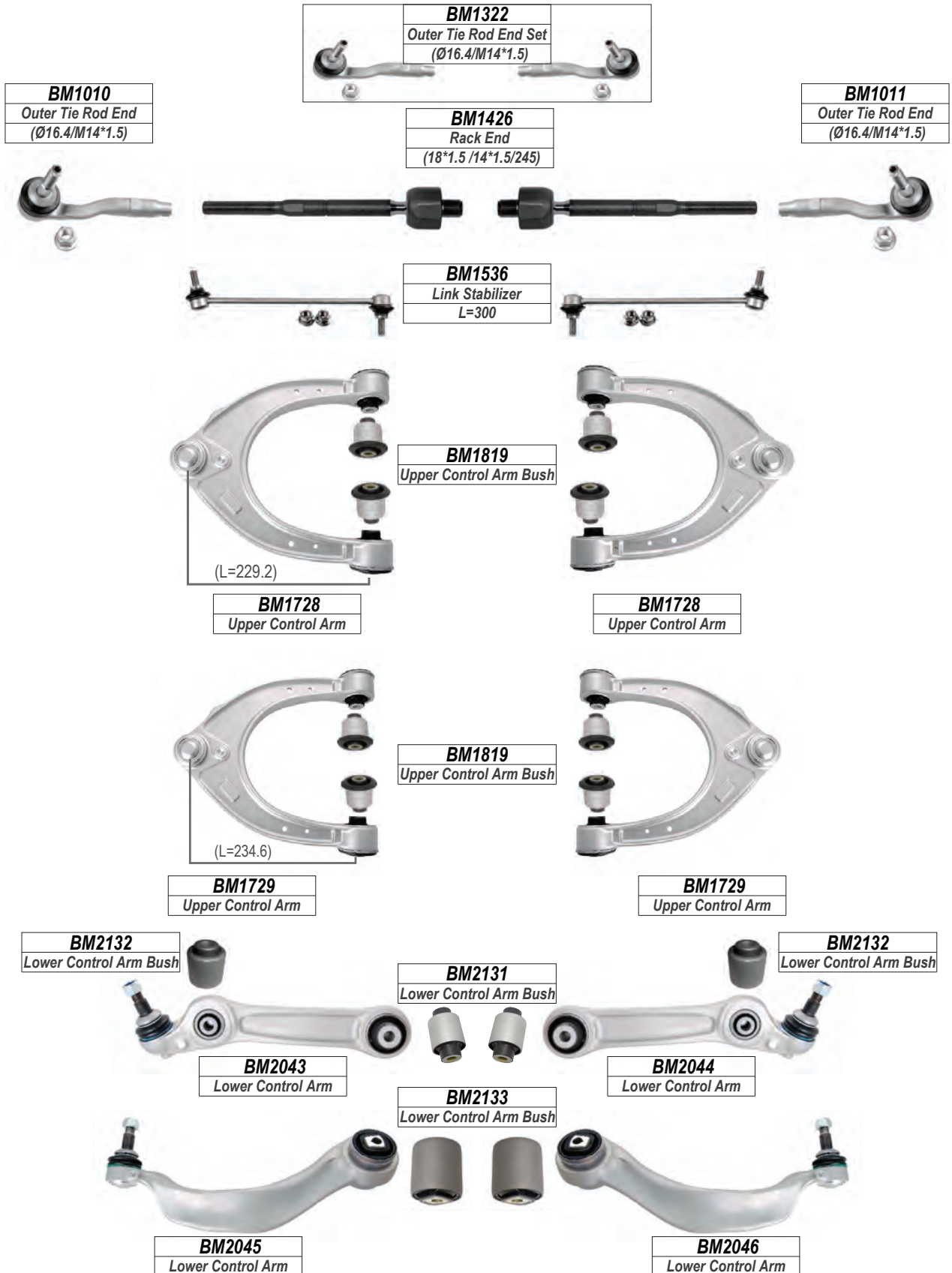

**LEFT**

**RIGHT**

**BMW**

**5 SERIES**

**REAR**

**F07(GRAN TURISMO)**

**Year**

**2009-**

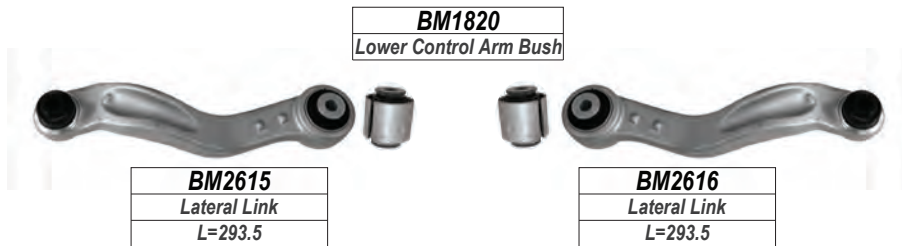
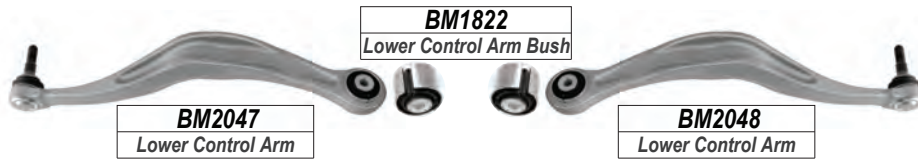

**LEFT**

**RIGHT**

**BMW**

6 SERIES

FRONT

E24

Year

1980-1990

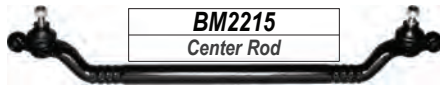

**BM2215**  
Center Rod

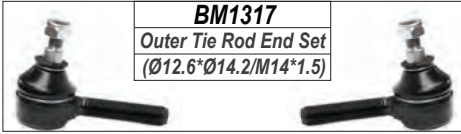

**BM1317**  
Outer Tie Rod End Set  
(Ø12.6\*Ø14.2/M14\*1.5)

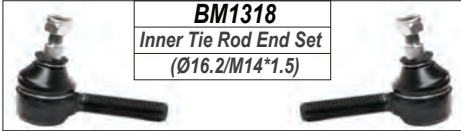

**BM1318**  
Inner Tie Rod End Set  
(Ø16.2/M14\*1.5)

**BM1026**  
Outer Tie Rod End  
(Ø12.6\*Ø14.2/M14\*1.5)



**BM1110**  
Inner Tie Rod End  
(Ø12.6\*Ø14.2/M14\*1.5)



**BM1110**  
Inner Tie Rod End  
(Ø12.6\*Ø14.2/M14\*1.5)



**BM1026**  
Outer Tie Rod End  
(Ø12.6\*Ø14.2/M14\*1.5)



**BM2211**  
Center Rod



**BM2211**  
Center Rod

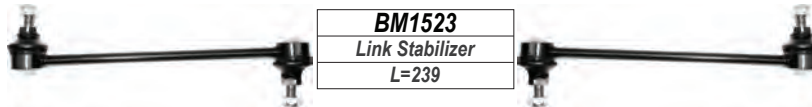

**BM1523**  
Link Stabilizer  
L=239



**BM1812**  
Upper Control Arm Bush

**BM1714**  
Upper Control Arm



**BM2126**  
Lower Control Arm Bush

**BM1715**  
Upper Control Arm



**BM2029**  
Lower Control Arm



**BM2030**  
Lower Control Arm



**BM2924**  
Bush  
(ID:Ø10.22/OD:Ø36/L=48)



**BM2410**  
Idler Arm



**BM2924**  
Bush  
(ID:Ø10.22/OD:Ø36/L=48)



6 SERIES

REAR

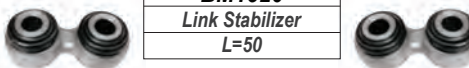

**BM1526**  
Link Stabilizer  
L=50

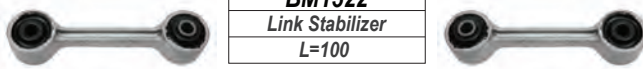

**BM1522**  
Link Stabilizer  
L=100

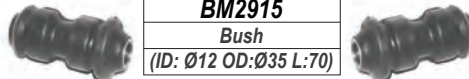

**BM2915**  
Bush  
(ID: Ø12 OD:Ø35 L:70)

LEFT

RIGHT

**BMW**

**6 SERIES**

**FRONT**

**E63.E64**

*Year*

**2004-2011**

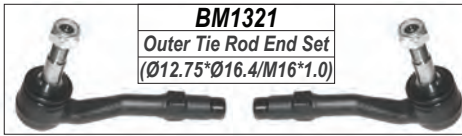

**BM1321**  
Outer Tie Rod End Set  
(Ø12.75\*Ø16.4/M16\*1.0)

**BM1031**  
Outer Tie Rod End  
(Ø16.2/M16\*1.5)



**BM1416**  
Rack End  
(18\*1.5 /16\*1.5/241)



**BM1031**  
Outer Tie Rod End  
(Ø16.2/M16\*1.5)

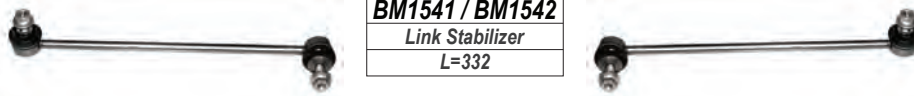

**BM1541 / BM1542**  
Link Stabilizer  
L=332



**BM1823**  
Upper Control Arm Bush

**BM1739**  
Upper Control Arm



**BM1740**  
Upper Control Arm



**BM2127**  
Lower Control Arm Bush

**BM2049**  
Lower Control Arm



**BM2050**  
Lower Control Arm



**BM2813**  
Shock Mounting



**BM2813**  
Shock Mounting



**5 SERIES**

**REAR**

**BM1818**  
Upper Control Arm Bush



**BM1726**  
Upper Control Arm

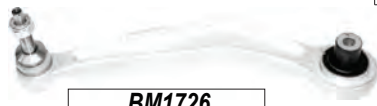

**BM1727**  
Upper Control Arm



**BM1530**  
Link Stabilizer  
L=93.5

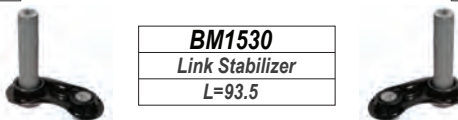

**BM1535**  
Link Stabilizer  
L=102



**LEFT**

**RIGHT**



**BMW**

**6 SERIES**

**FRONT**

**F12.F13 COUPE**

**Year**

**2011-**

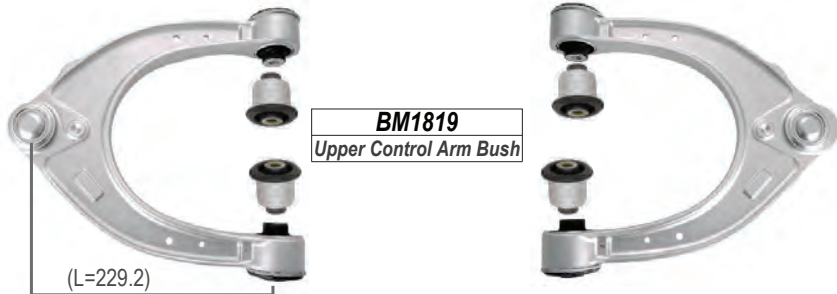
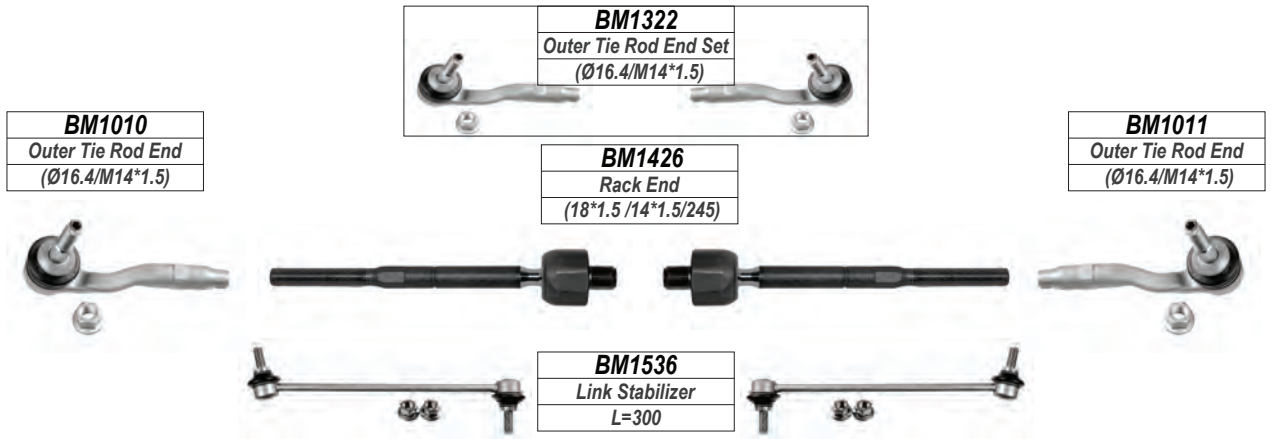

**LEFT**

**RIGHT**

<b>BMW</b>		Year
<b>6 SERIES</b>	<b>REAR</b>	<b>2011-</b>
	<b>F12.F13 COUPE</b>	

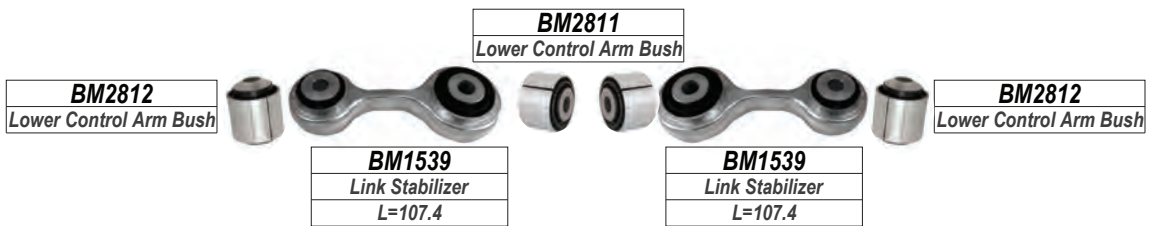
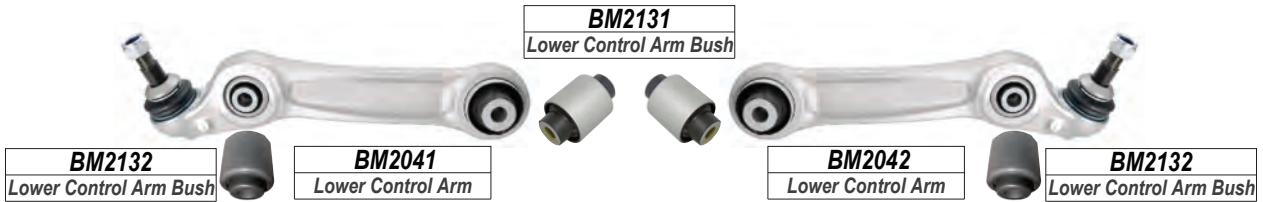
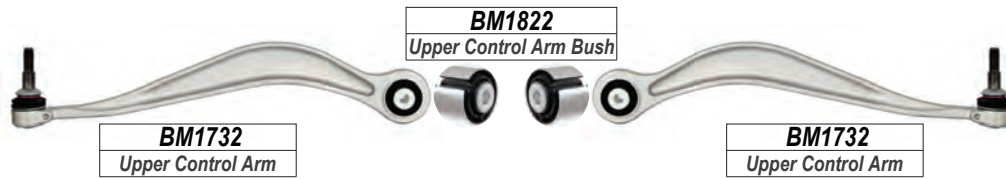

**LEFT**

**RIGHT**

**BMW**

**7 SERIES**

**FRONT**

**E32**

*Year*

**1986-1994**

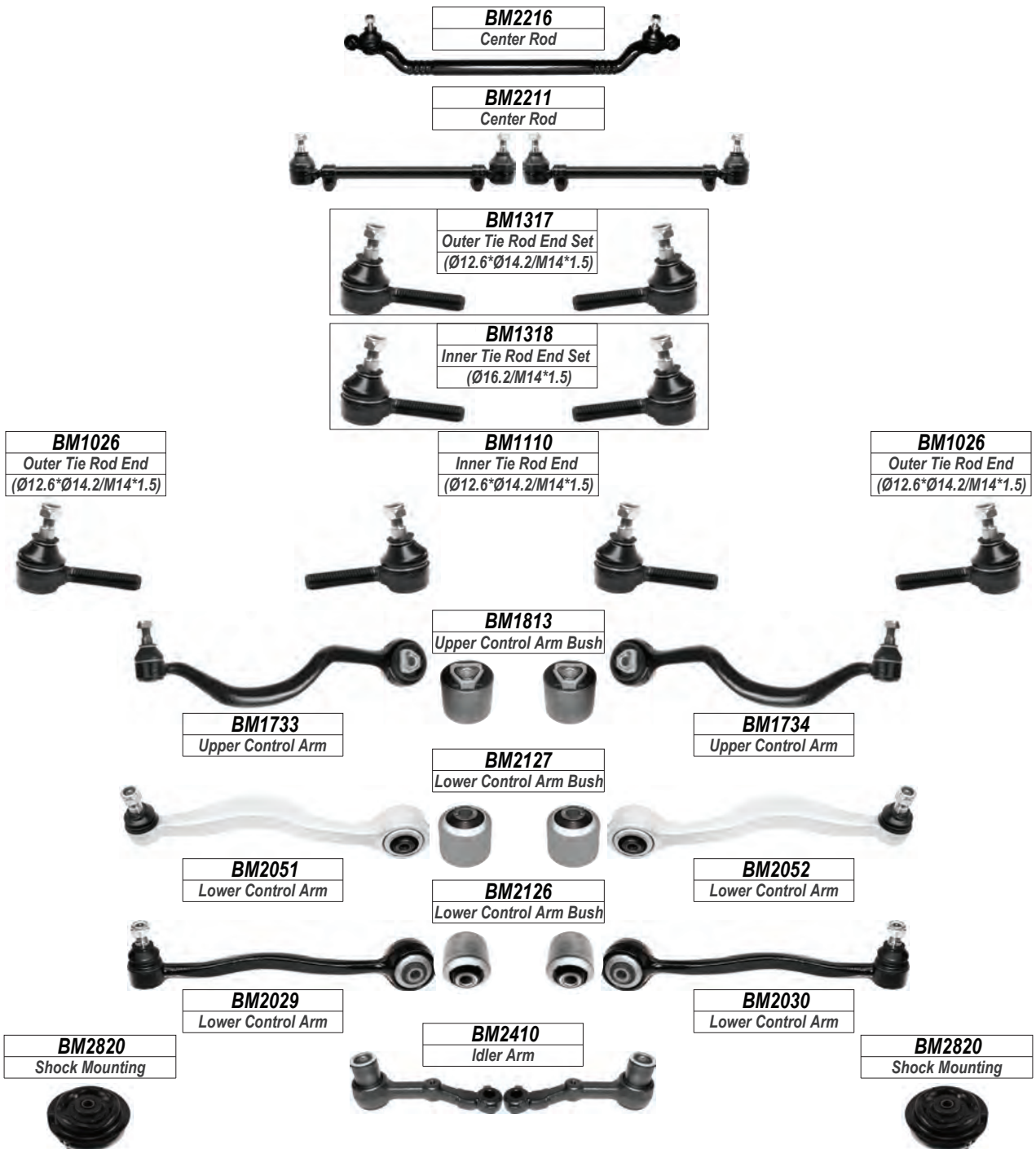

**7 SERIES**

**REAR**

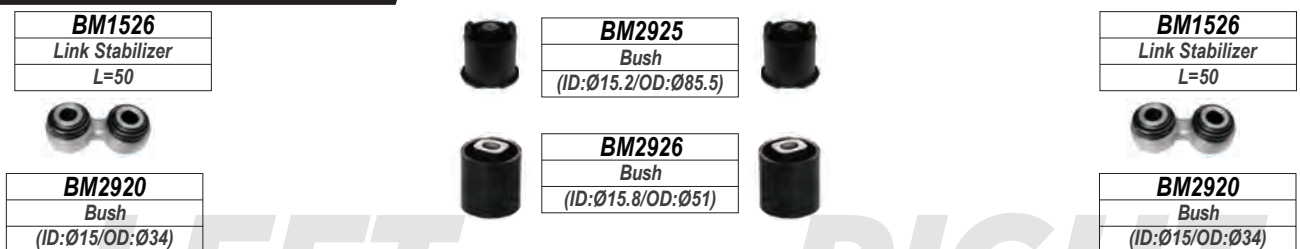

**LEFT**

**RIGHT**

**BMW**

**7 SERIES**

**FRONT**

**E38**

*Year*

**1994-2003**

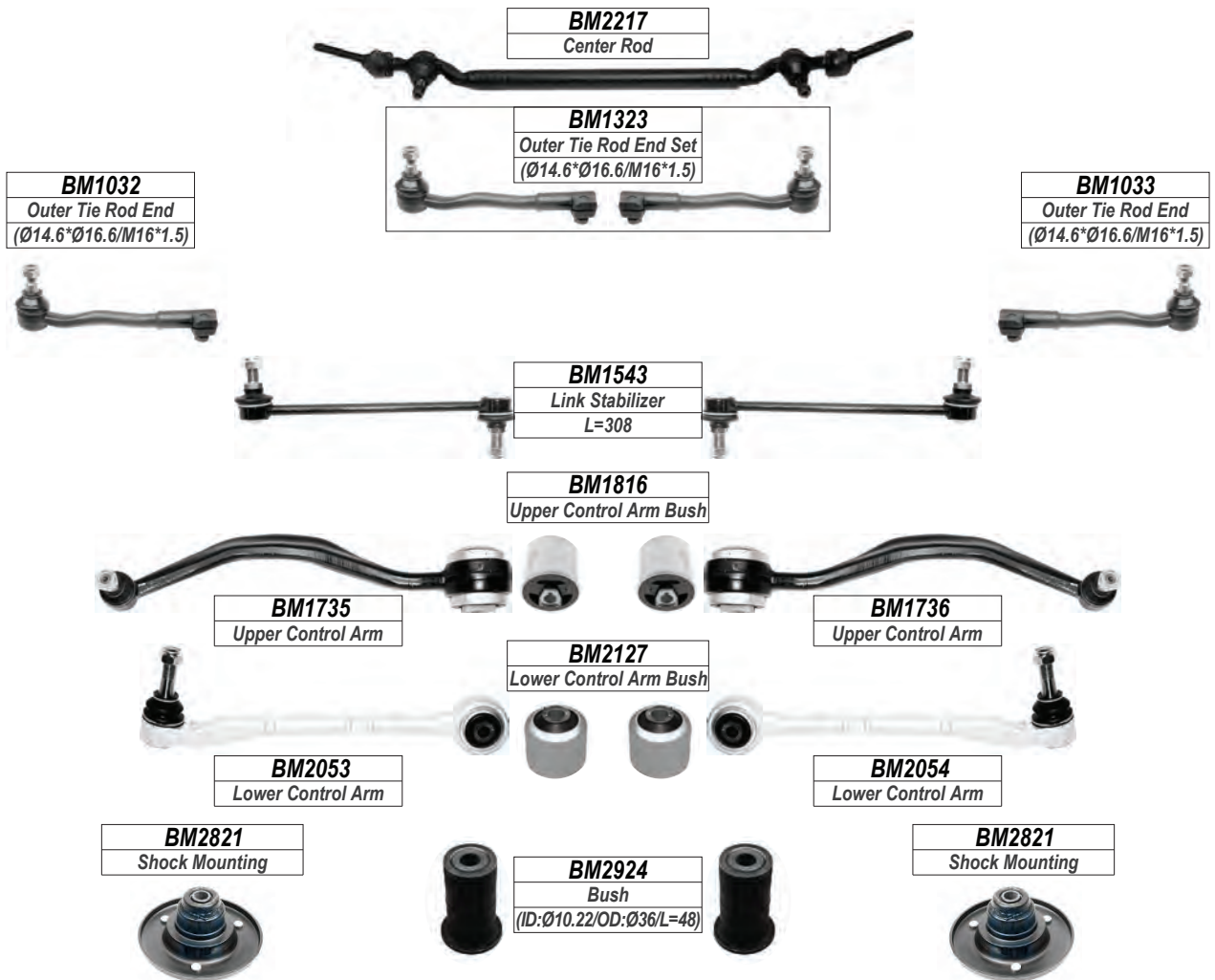

**7 SERIES**

**REAR**

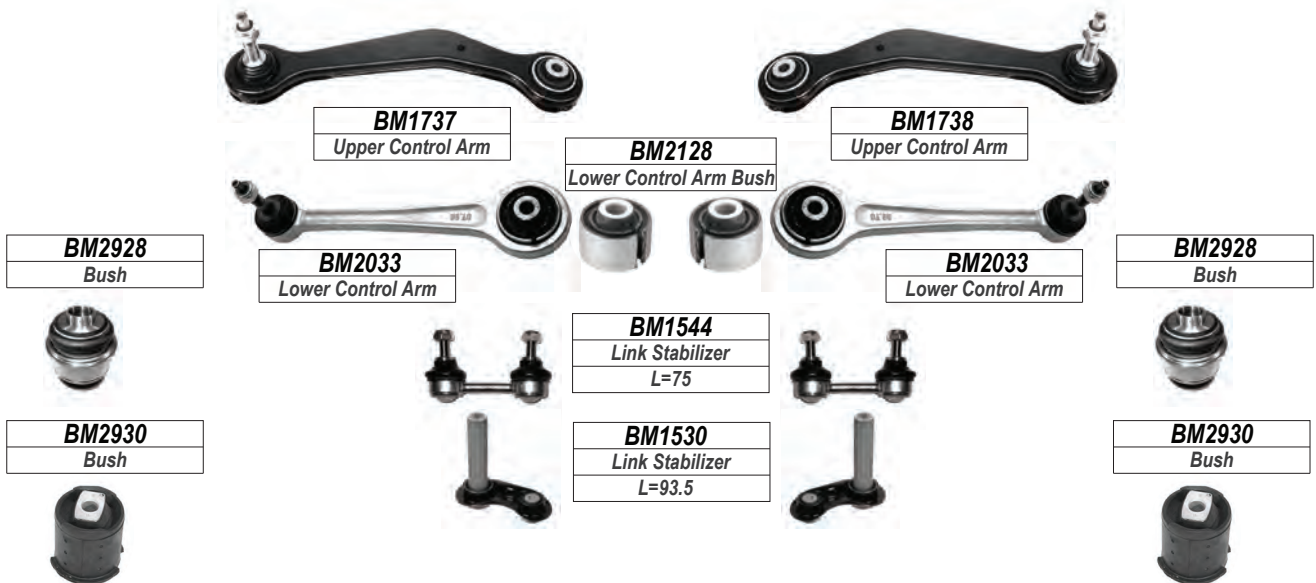

**LEFT**

**RIGHT**



**BMW**

**7 SERIES**

**FRONT**

**E65.E66**

*Year*

**2001-2008**

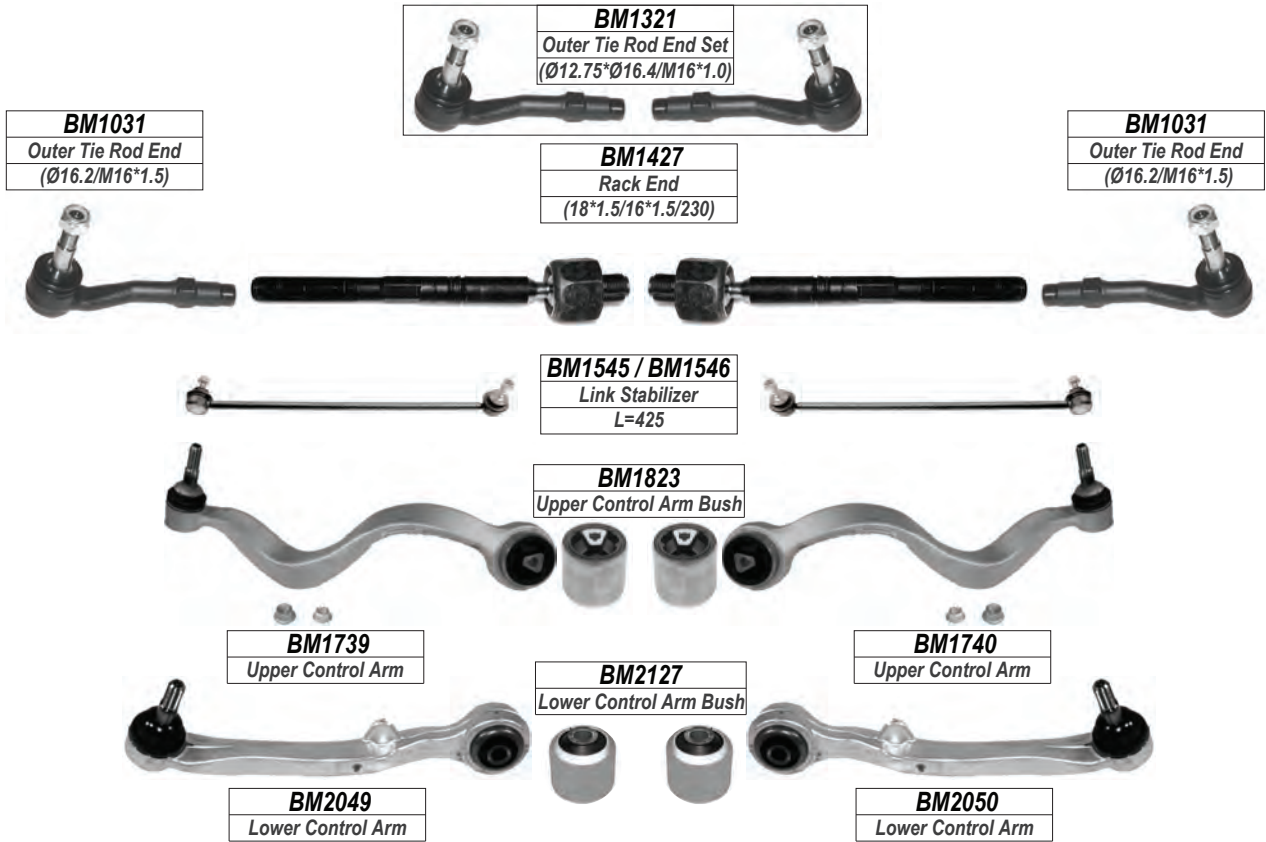

**5 SERIES**

**REAR**

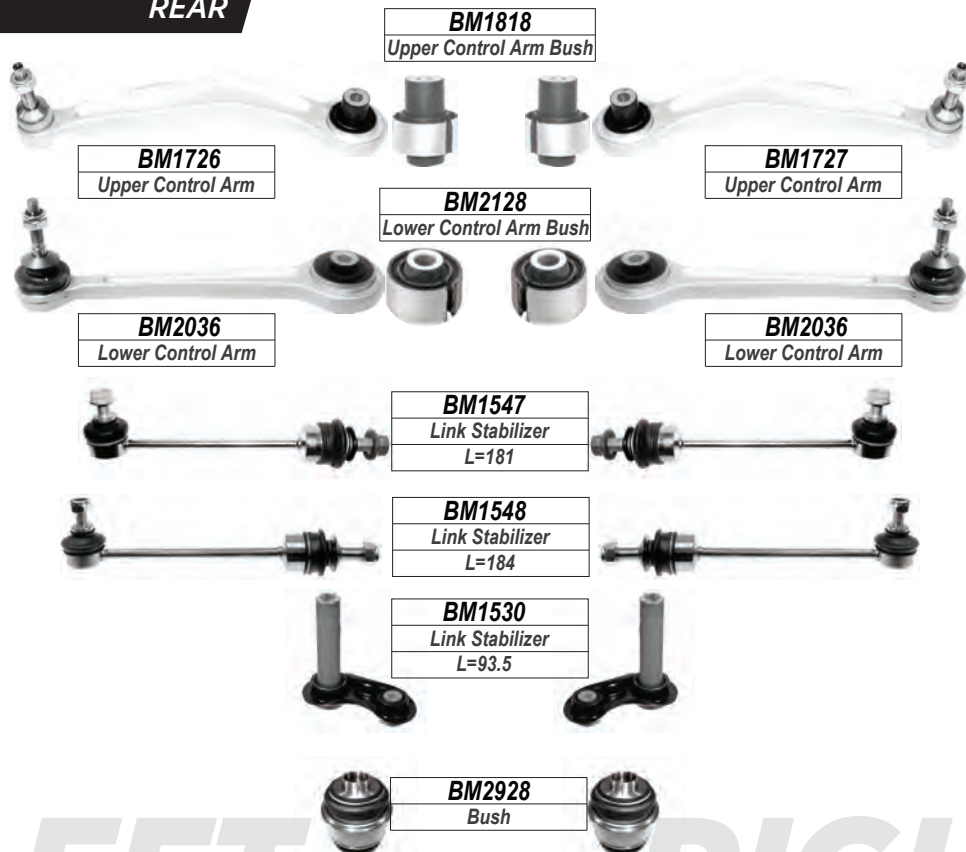

**LEFT**

**RIGHT**



**BMW**

**7 SERIES**

**FRONT**

**F01.F02.F03.F04**

**Year**

**2008-**

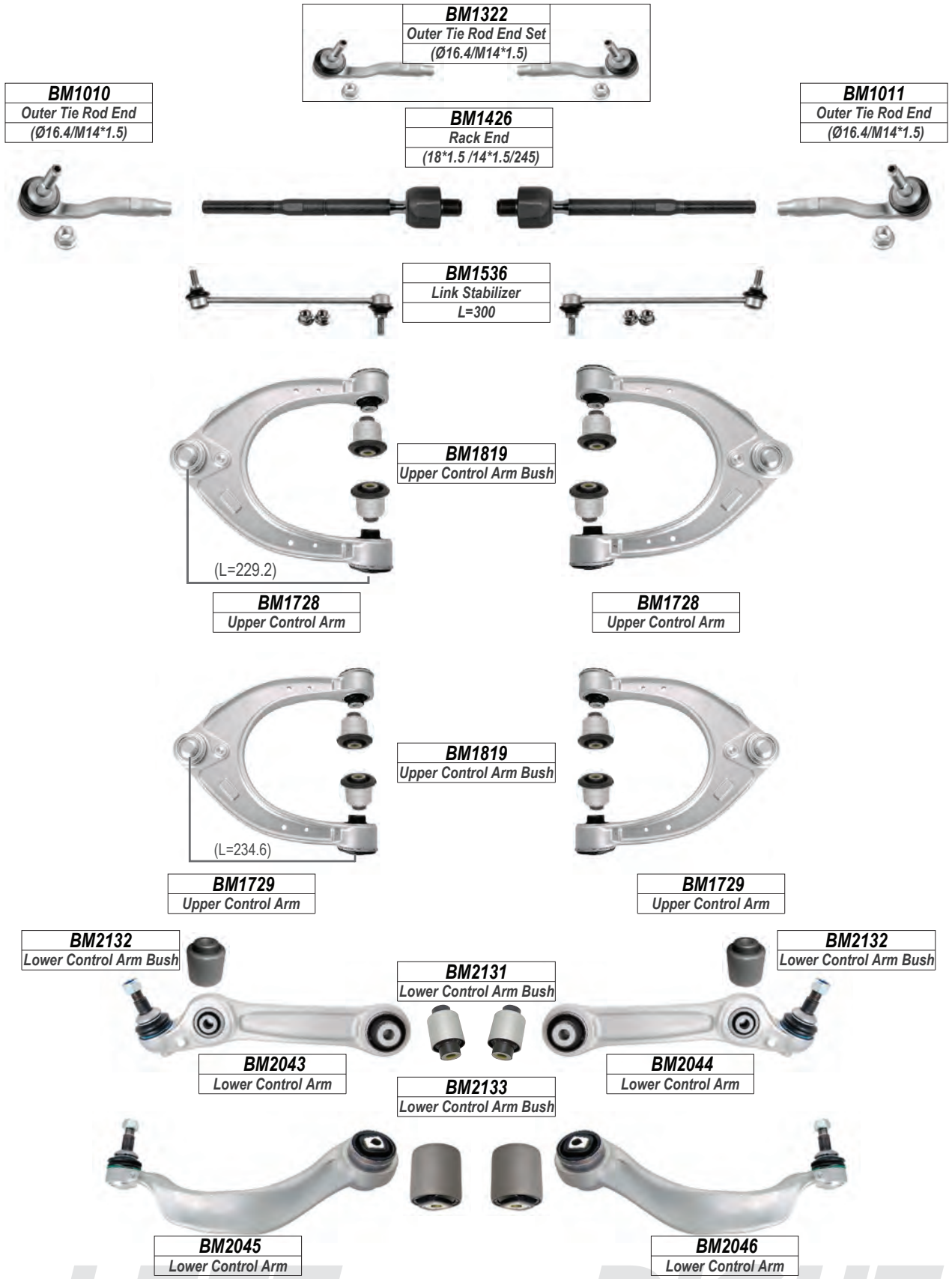

**LEFT**

**RIGHT**

**BMW**

**7 SERIES**

**FRONT**

**F01.F02.F03.F04**

**Year**

**2008-**

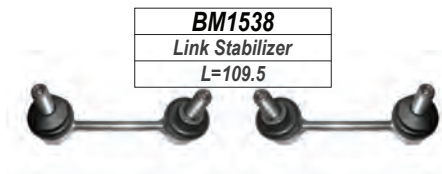
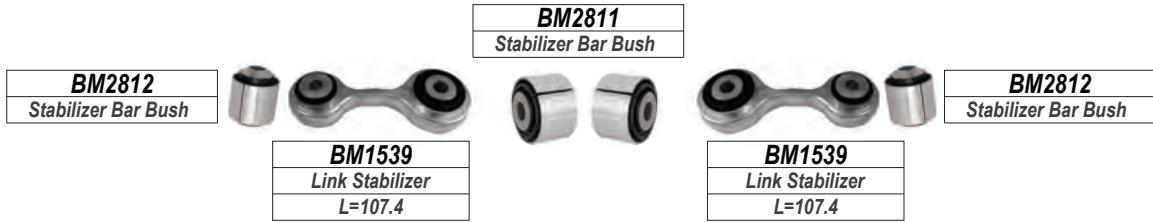

**LEFT**

**RIGHT**

**BMW**

**X1**

**FRONT**

**E84.E84 XD**

**Year**

**2009-2015**

**BM1013**  
Outer Tie Rod End  
(Ø15.7/M14\*1.5)

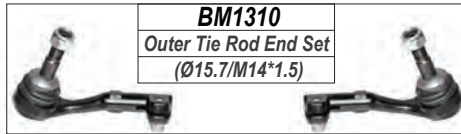

**BM1310**  
Outer Tie Rod End Set  
(Ø15.7/M14\*1.5)

**BM1417**  
Rack End  
(18\*1.5 /14\*1.5/259)

**BM1014**  
Outer Tie Rod End  
(Ø15.7/M14\*1.5)



**BM1510 / BM1511**  
Link Stabilizer  
L=290

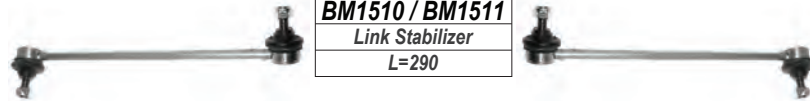

**BM1512 / BM1513**  
Link Stabilizer  
L=290(AI.)



**BM1550 / BM1551**  
Link Stabilizer  
L=340(AI.)(XD Only)

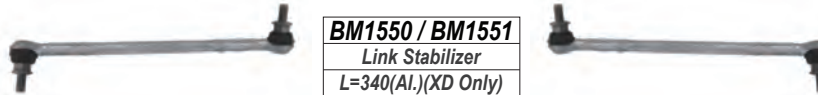

**BM1810**  
Upper Control Arm Bush



**BM1710**  
Upper Control Arm

**BM2110**  
Lower Control Arm Bush

**BM1711**  
Upper Control Arm



**BM2010**  
Lower Control Arm

**BM2011**  
Lower Control Arm



**BM1612**  
Upper Ball Joint  
(Ø17.9)



**BM1612**  
Upper Ball Joint  
(Ø17.9)

**BM1741**  
Upper Control Arm  
XD Only

**BM1742**  
Upper Control Arm  
XD Only



**BM2124**  
Lower Control Arm Bush



**BM2022**  
Lower Control Arm  
XD Only

**BM2022**  
Lower Control Arm  
XD Only



**BM2813**  
Shock Mounting



**BM2813**  
Shock Mounting



**LEFT**

**RIGHT**

<b>BMW</b>		Year	
<b>X1</b>	<b>REAR</b>	<b>E84.E84 XD</b>	<b>2009-2015</b>

**BM1517 / BM1518**  
Link Stabilizer  
L=135



**BM2910**  
Bush

**BM2910**  
Bush



**BM2910**  
Bush

**BM2611**  
Lateral Link  
L=413.5

**BM2611**  
Lateral Link  
L=413.5

**BM2911**  
Bush

**BM2913**  
Bush



**BM2913**  
Bush

**BM2612**  
Lateral Link  
L=273

**BM2612**  
Lateral Link  
L=273

**BM2912**  
Bush

**BM2913**  
Bush



**BM2913**  
Bush

**BM2613**  
Lateral Link  
L=240

**BM2613**  
Lateral Link  
L=240

**LEFT**

**RIGHT**

**BMW**

X1

FRONT

F48

Year

2015-

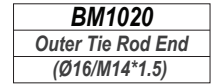
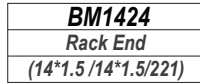
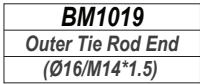
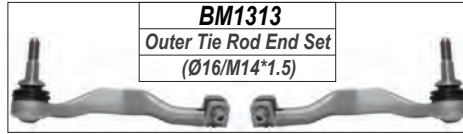

LEFT

RIGHT



**BMW**

**X3**

**FRONT**

**E83**

**Year**

**2004-2010**

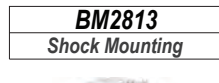
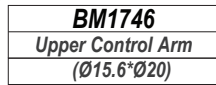
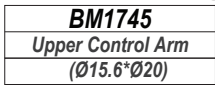
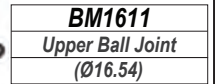
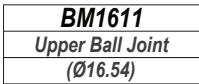
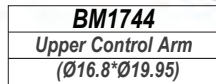
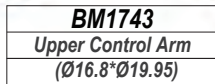
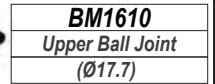
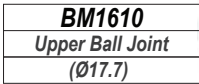
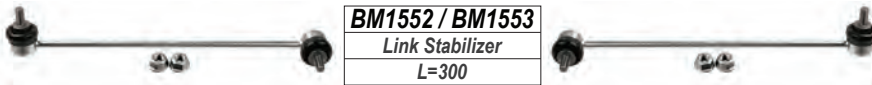
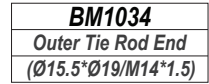
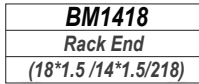
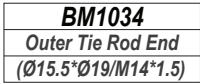
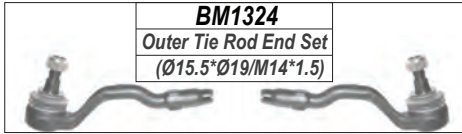

**X3 REAR**

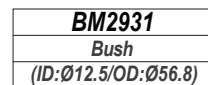
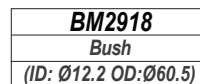
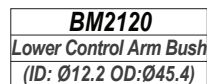
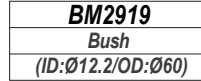
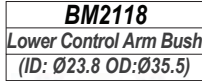
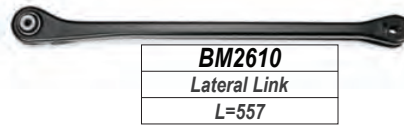
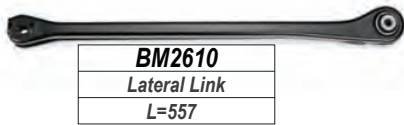

**LEFT**

**RIGHT**

<b>BMW</b>			Year
<b>X3</b>	<b>FRONT</b>	<b>F25</b>	<b>2010-</b>

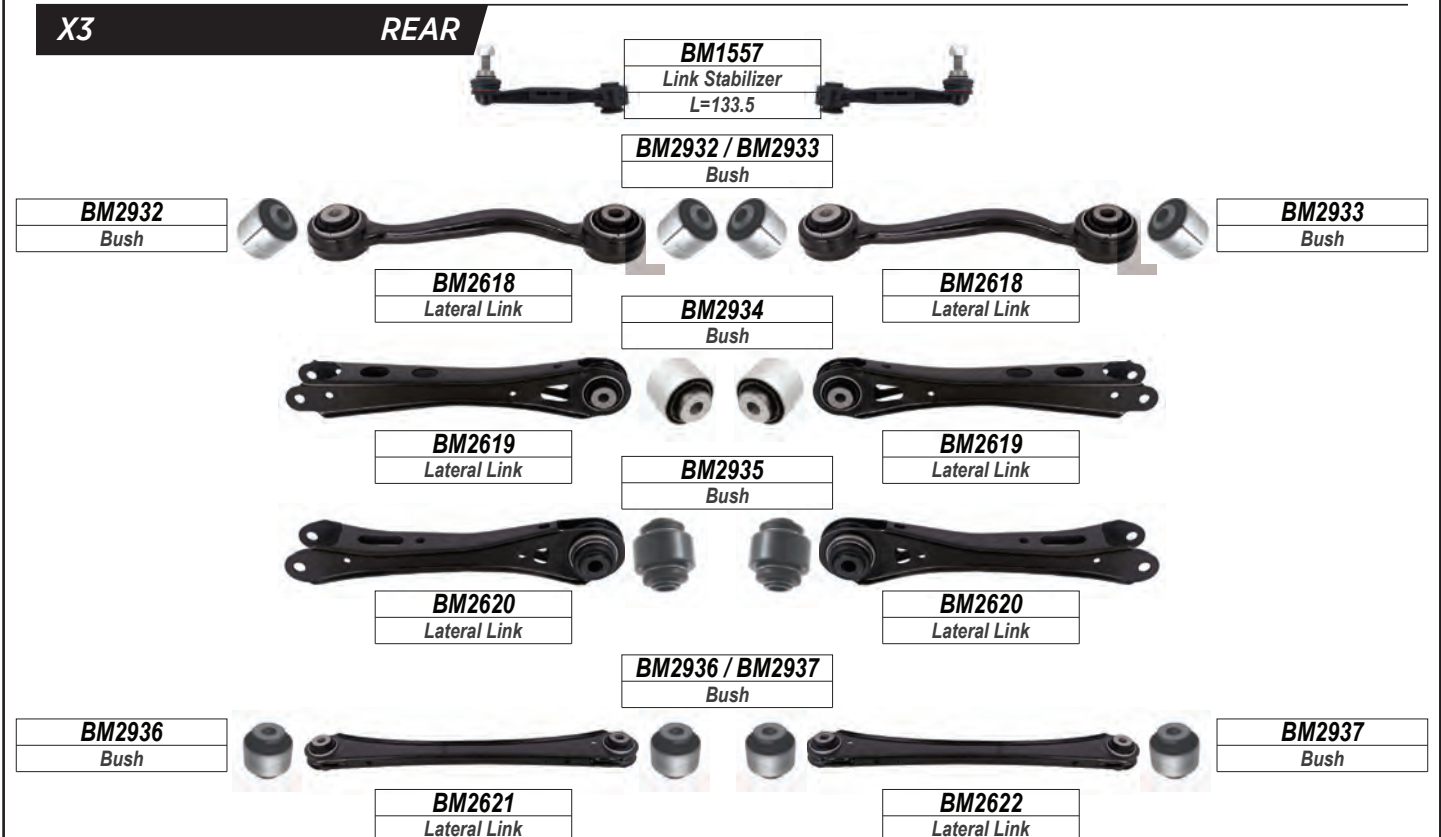
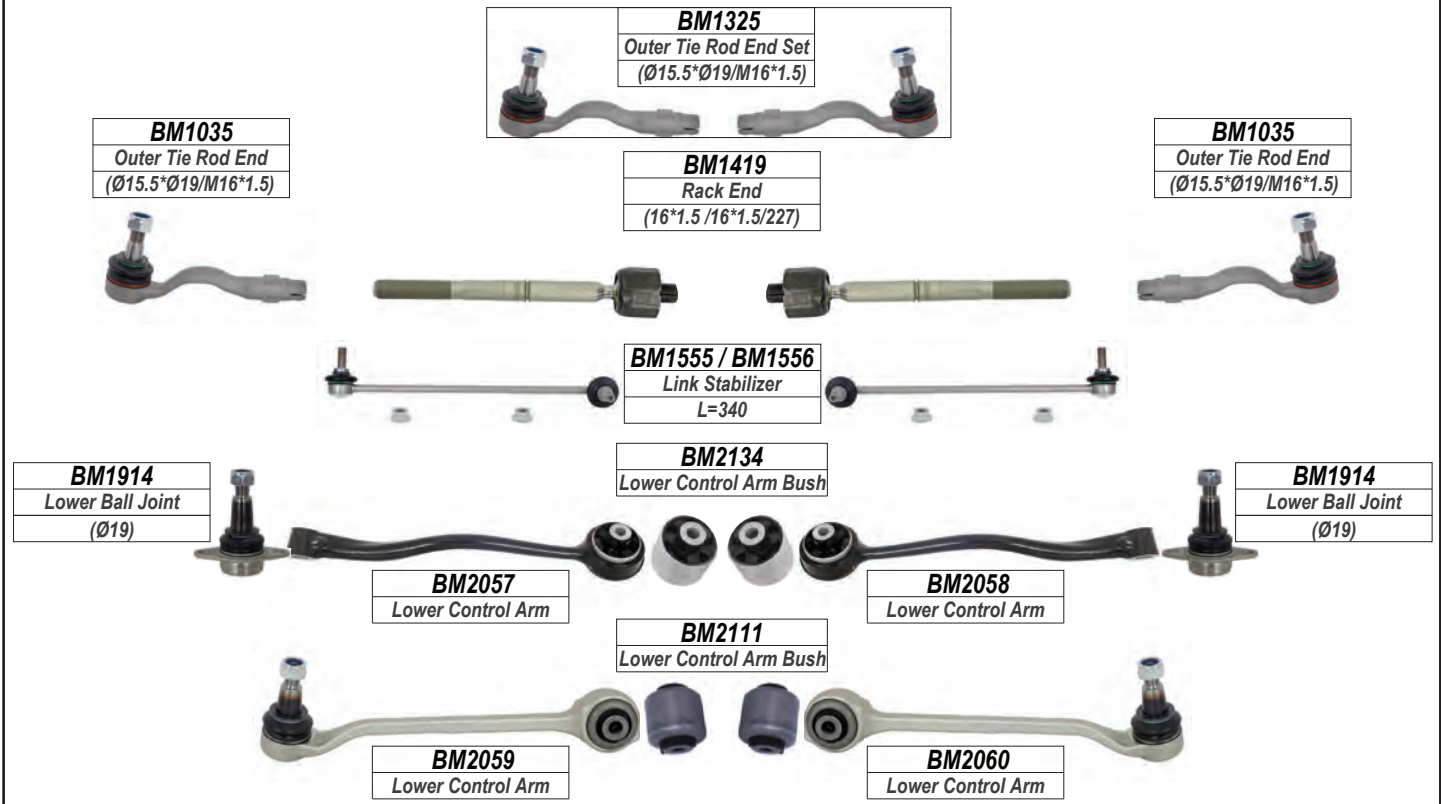

**LEFT**

**RIGHT**

**BMW**

**X4**

**FRONT**

**F26**

**Year**

**2014-**

**BM1035**  
Outer Tie Rod End  
(Ø15.5\*Ø19/M16\*1.5)

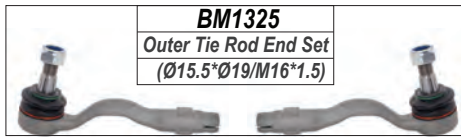

**BM1325**  
Outer Tie Rod End Set  
(Ø15.5\*Ø19/M16\*1.5)

**BM1419**  
Rack End  
(16\*1.5 / 16\*1.5/227)

**BM1035**  
Outer Tie Rod End  
(Ø15.5\*Ø19/M16\*1.5)



**BM1555 / BM1556**  
Link Stabilizer  
L=340

**BM1914**  
Lower Ball Joint  
(Ø19)



**BM2134**  
Lower Control Arm Bush

**BM1914**  
Lower Ball Joint  
(Ø19)



**BM2057**  
Lower Control Arm



**BM2058**  
Lower Control Arm



**BM2111**  
Lower Control Arm Bush

**BM2059**  
Lower Control Arm



**BM2060**  
Lower Control Arm



**X4**

**REAR**



**BM1557**  
Link Stabilizer  
L=133.5

**BM2932 / BM2933**  
Bush

**BM2932**  
Bush



**BM2618**  
Lateral Link



**BM2934**  
Bush



**BM2618**  
Lateral Link



**BM2933**  
Bush



**BM2619**  
Lateral Link



**BM2935**  
Bush



**BM2619**  
Lateral Link



**BM2620**  
Lateral Link



**BM2936 / BM2937**  
Bush



**BM2620**  
Lateral Link



**BM2936**  
Bush



**BM2621**  
Lateral Link



**BM2622**  
Lateral Link



**BM2937**  
Bush



**LEFT**

**RIGHT**

**BMW**

X5

FRONT

E53

Year

2000-2007

**BM1036**  
Outer Tie Rod End  
(Ø15.4\*Ø18.3/M14\*1.5)



**BM1037**  
Outer Tie Rod End  
(Ø15.4\*Ø18.4/M14\*1.5)

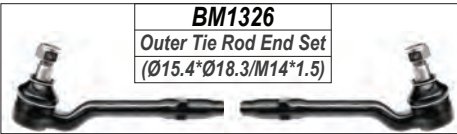

**BM1326**  
Outer Tie Rod End Set  
(Ø15.4\*Ø18.3/M14\*1.5)



**BM1327**  
Outer Tie Rod End Set  
(Ø15.4\*Ø18.4/M14\*1.5)

**BM1420**  
Rack End  
(18\*1.5 /14\*1.5/220)



**BM1036**  
Outer Tie Rod End  
(Ø15.4\*Ø18.3/M14\*1.5)



**BM1037**  
Outer Tie Rod End  
(Ø15.4\*Ø18.4/M14\*1.5)



**BM1558 / BM1559**  
Link Stabilizer  
L=359

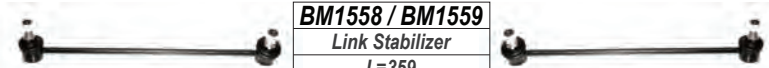

**BM1824**  
Upper Control Arm Bush



**BM1612**  
Upper Ball Joint  
(Ø17.9)



**BM1747**  
Upper Control Arm



**BM1748**  
Upper Control Arm



**BM1612**  
Upper Ball Joint  
(Ø17.9)



**BM2126**  
Lower Control Arm Bush



**BM2822**  
Shock Mounting



**BM2061**  
Lower Control Arm



**BM2062**  
Lower Control Arm



**BM2822**  
Shock Mounting



X5

REAR

**BM1825**  
Upper Control Arm Bush



**BM2823**  
Shock Mounting



**BM1749**  
Upper Control Arm



**BM1749**  
Upper Control Arm



**BM2823**  
Shock Mounting



**BM2623**  
Lateral Link



**BM2624**  
Lateral Link



**BM2928**  
Bush



**BM1560**  
Link Stabilizer  
L=65



**BM2928**  
Bush



**BM1530**  
Link Stabilizer  
L=93.5

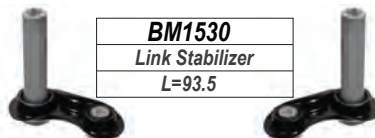

LEFT

RIGHT



**BMW**

**X5**

**FRONT**

**E70. X-DRIVE**

*Year*

**2007-2014**

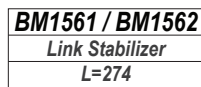
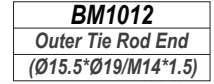
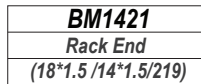
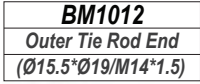
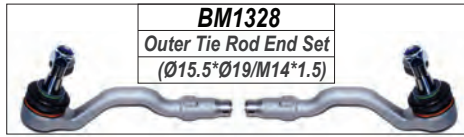

**LEFT**

**RIGHT**



**BMW**

**X5**

**REAR**

**E70. X-DRIVE**

*Year*

**2007-2014**

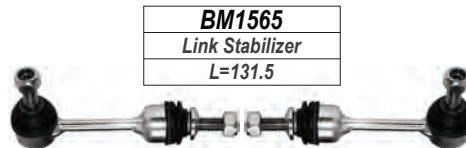

**BM2825**  
Shock Mounting



**BM2825**  
Shock Mounting



**LEFT**

**RIGHT**

**BMW**

X5

FRONT

F15

Year

2014-

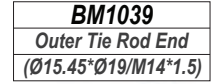
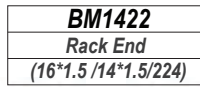
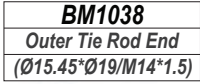
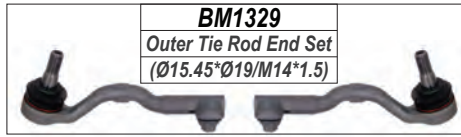

**BM1756**  
Upper Control Arm



**BM1757**  
Upper Control Arm



**BM2069**  
Lower Control Arm



**BM2070**  
Lower Control Arm



**BM2067**  
Lower Control Arm



**BM2068**  
Lower Control Arm



LEFT

RIGHT

**BMW**

**X5**

**REAR**

**F15**

*Year*

**2014-**

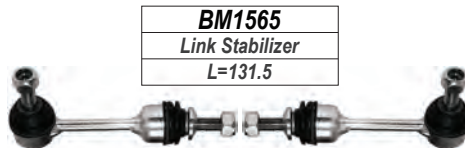

**LEFT**

**RIGHT**

**BMW**

**X6**

**FRONT**

**E71**

*Year*

**2009-2014**

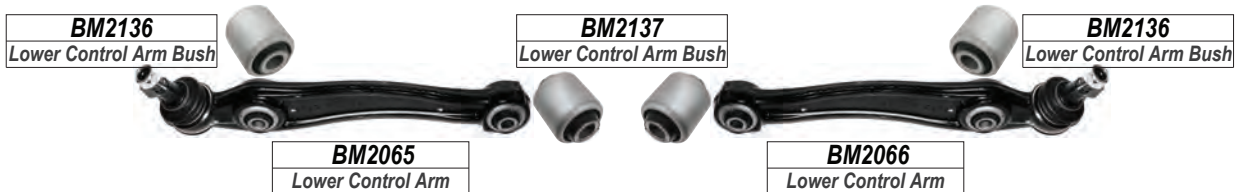
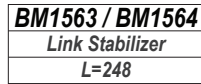
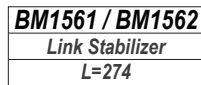
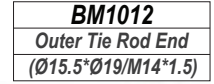
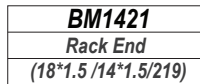
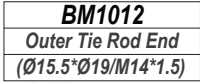
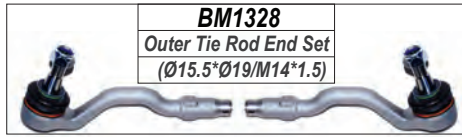

**LEFT**

**RIGHT**

**BMW**

**X6**

**REAR**

**E71**

*Year*

**2009-2014**

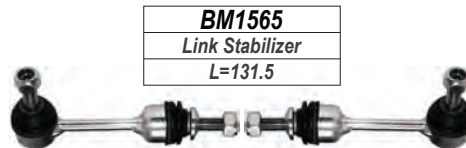

**BM2825**  
Shock Mounting

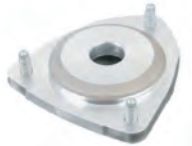

**BM2825**  
Shock Mounting



**LEFT**

**RIGHT**



**BMW**

X6

FRONT

F16

Year

2014-

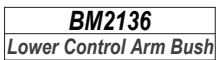
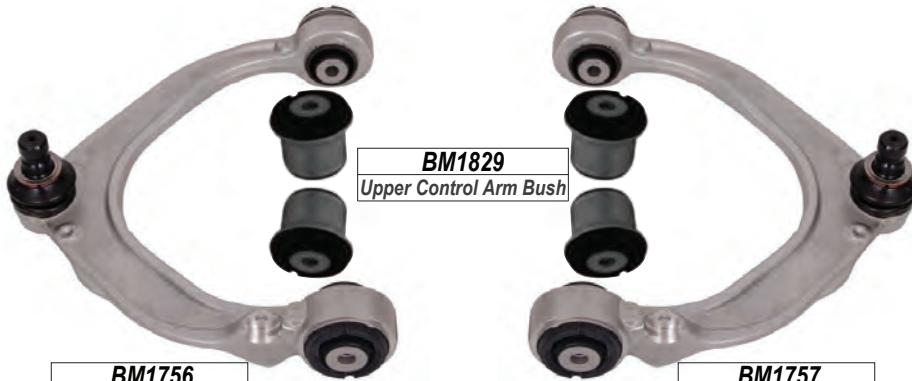
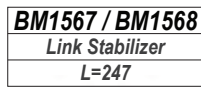
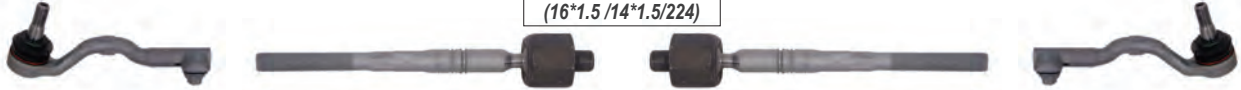
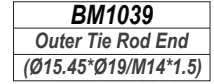
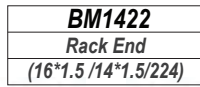
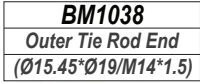
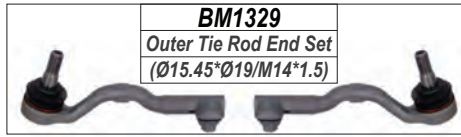

LEFT

RIGHT

**BMW**

**X6**

**REAR**

**F16**

*Year*

**2014-**

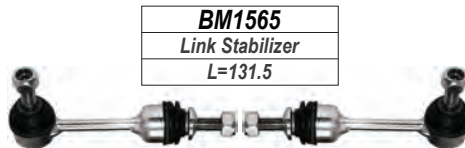

**LEFT**

**RIGHT**

**CAM**

INYATHI

FRONT

P/VAN.BUS

Year

2006-

**CA1010**  
Outer Tie Rod End  
(Ø14.6\*Ø16.5/M17\*1.5)

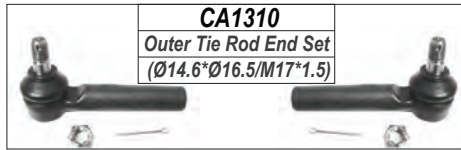

**CA1310**  
Outer Tie Rod End Set  
(Ø14.6\*Ø16.5/M17\*1.5)

**CA1010**  
Outer Tie Rod End  
(Ø14.6\*Ø16.5/M17\*1.5)



**CA1410**  
Rack End  
(14\*1.5/17\*1.5/276)

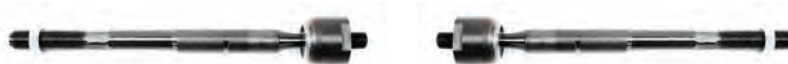

**CA1011**  
Outer Tie Rod End  
(Ø14.7\*Ø16/M15\*1.5)

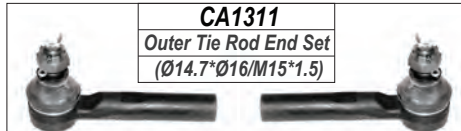

**CA1311**  
Outer Tie Rod End Set  
(Ø14.7\*Ø16/M15\*1.5)

**CA1011**  
Outer Tie Rod End  
(Ø14.7\*Ø16/M15\*1.5)



**CA1411**  
Rack End  
(14\*1.5/15\*1.5/274)



**CA1611**  
Upper Ball Joint  
(Ø17.5)



**CA1611**  
Upper Ball Joint  
(Ø17.5)



**CA1910**  
Lower Ball Joint  
(Ø18)



**CA2010**  
Lower Control Arm



**CA2011**  
Lower Control Arm

**CA1910**  
Lower Ball Joint  
(Ø18)



LEFT

RIGHT

**CAM**

**RHINO**

**FRONT**

**2.2**

*Year*

**2007-**

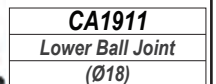
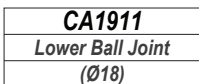
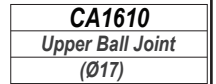
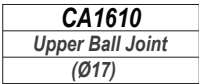
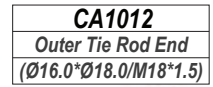
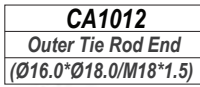
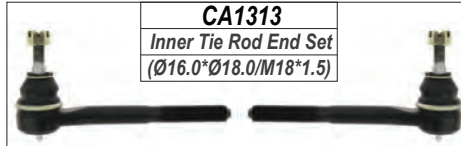
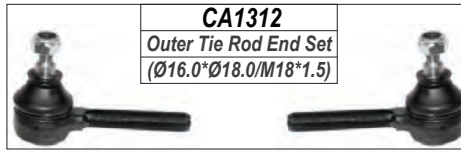

**LEFT**

**RIGHT**

**CHANA**

*Year*

**STAR**

**FRONT**

**ALL**

**2006-**

<b>CN1410</b>
<i>Rack End</i>
<i>(14*1.5/17*1.5/276)</i>



<b>CN1910</b>
<i>Lower Ball Joint</i>
<i>(Ø18)</i>



<b>CN1910</b>
<i>Lower Ball Joint</i>
<i>(Ø18)</i>



**LEFT**

**RIGHT**



**CHERY**

QQ3

FRONT

0.8.1.0

Year

2008-

**CY1010**  
Outer Tie Rod End  
(Ø12.6\*Ø14.5/M12\*1.5)

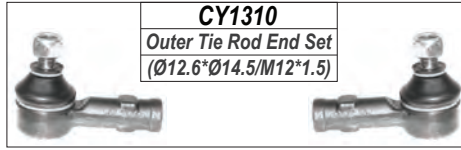

**CY1310**  
Outer Tie Rod End Set  
(Ø12.6\*Ø14.5/M12\*1.5)

**CY1410**  
Rack End  
(16\*1.5/12\*1.5/250)



**CY1010**  
Outer Tie Rod End  
(Ø12.6\*Ø14.5/M12\*1.5)



**CY2010**  
Lower Control Arm



**CY2010**  
Lower Control Arm

**LEFT**

**RIGHT**

**CHERY**

**TIGGO**

**FRONT**

**1.6.2.0**

*Year*

**2008-**

**CY1011**  
Outer Tie Rod End  
(Ø12.5\*Ø15/M15\*1.5)

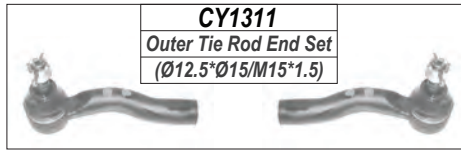

**CY1012**  
Outer Tie Rod End  
(Ø12.5\*Ø15/M15\*1.5)

**CY1411**  
Rack End  
(14\*1.5/15\*1.5/298)



**CY1510**  
Link Stabilizer  
L=285



**CY1910**  
Lower Ball Joint  
(Ø15)



**CY2011**  
Lower Control Arm



**CY2012**  
Lower Control Arm

**CY1910**  
Lower Ball Joint  
(Ø15)



**TIGGO**

**REAR**

**CY1511 / CY1512**  
Link Stabilizer  
L=100



**LEFT**

**RIGHT**

**CHEVROLET**

**AVEO**

**FRONT**

**1.0 LS.LT.1.5 LS.LT.T200.T250**

**Year**

**2003-2011**

**CH1010**  
Outer Tie Rod End  
(Ø13.2\*Ø15/M12\*1.5)



**CH1310**  
Outer Tie Rod End Set  
(Ø13.2\*Ø15/M12\*1.5)

**CH1011**  
Outer Tie Rod End  
(Ø13.2\*Ø15/M12\*1.5)



**CH1410**  
Rack End  
(16\*1.5 /12\*1.5/200)



**CH1510**  
Link Stabilizer  
L=261



**CH1911**  
Lower Ball Joint  
(Ø14.9)



**CH2111**  
Lower Control Arm Bush



**CH1911**  
Lower Ball Joint  
(Ø14.9)



**CH2010**  
Lower Control Arm



**CH2011**  
Lower Control Arm



**CH2110**  
Lower Control Arm Bush



**CH2810**  
Shock Mounting



**CH2810**  
Shock Mounting



**AVEO**

**REAR**

**CH1511**  
Link Stabilizer  
L=247



**LEFT**

**RIGHT**

**CHEVROLET**

AVEO

FRONT

T300

Year

2011-

**CH1012**  
Outer Tie Rod End  
(Ø13.2\*Ø15.1/M14\*1.5)

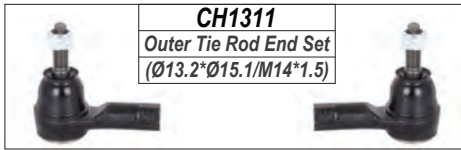

**CH1311**  
Outer Tie Rod End Set  
(Ø13.2\*Ø15.1/M14\*1.5)

**CH1411**  
Rack End  
(16\*1.5 /14\*1.5/328)

**CH1012**  
Outer Tie Rod End  
(Ø13.2\*Ø15.1/M14\*1.5)



**OP1421**  
Rack End  
(14\*1.5/14\*1.5/334)



**CH1512**  
Link Stabilizer  
L=295



**CH2112**  
Lower Control Arm Bush

**CH1912**  
Lower Ball Joint  
(Ø14.9)



**CH2012**  
Lower Control Arm



**CH2013**  
Lower Control Arm

**CH1912**  
Lower Ball Joint  
(Ø14.9)



**CH2113**  
Lower Control Arm Bush

LEFT

RIGHT

**CHEVROLET**

**CAPTIVA**

**FRONT**

Year

2.0.2.2.2.4LPG.3.0.3.2.C100.C140

2007-2011

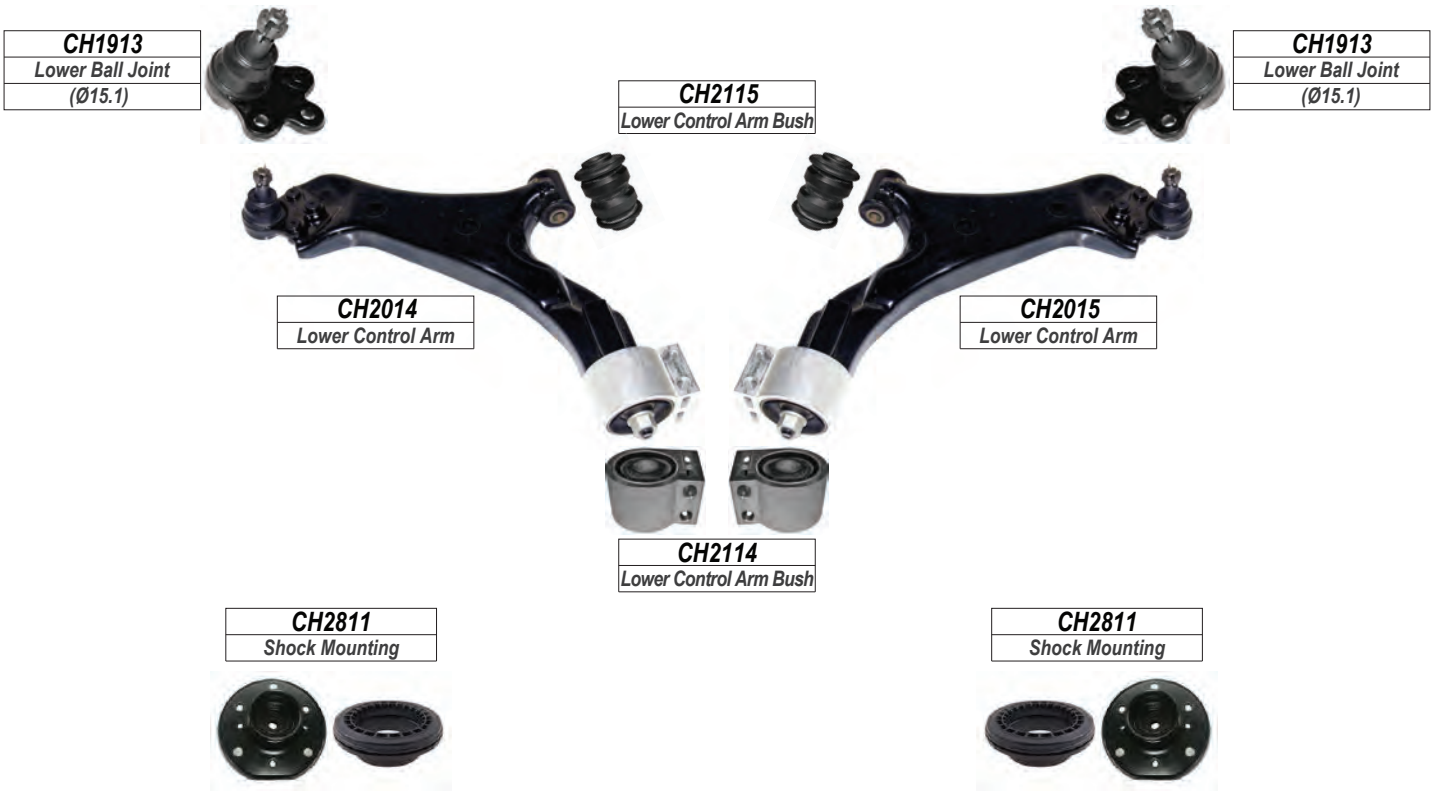

**CAPTIVA**

**REAR**



**LEFT**

**RIGHT**



**CHEVROLET**

**CAPTIVA**

**FRONT**

**2.2D.2.4.3.0**

*Year*

**2011-**

<b>CH1413</b>
<i>Rack End</i>
(16*1.5/14*1.5/328)



<b>CH1914</b>
---------------

<i>Lower Ball Joint</i>
(Ø15)



<b>CH1914</b>
---------------

<i>Lower Ball Joint</i>
(Ø15)



**LEFT**

**RIGHT**

**CHEVROLET**

**CRUZE**

**FRONT**

**1.6.1.8.2.0CDI.J300**

*Year*

**2009-2012**

**CH1014**  
Outer Tie Rod End  
(Ø13.1\*Ø18.1/M16\*1.5)

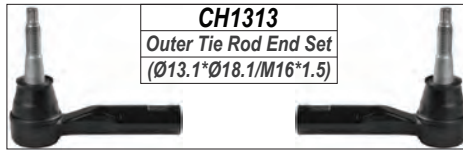

**CH1313**  
Outer Tie Rod End Set  
(Ø13.1\*Ø18.1/M16\*1.5)

**CH1014**  
Outer Tie Rod End  
(Ø13.1\*Ø18.1/M16\*1.5)



**CH1414**  
Rack End  
(16\*1.5 /16\*1.5/294)



**CH1516**  
Link Stabilizer  
L=304

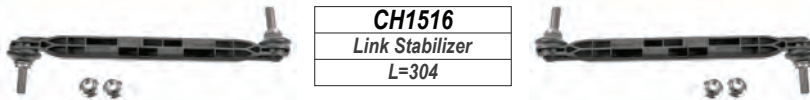

**CH2116**  
Lower Control Arm Bush



**CH2016**  
Lower Control Arm

**CH2017**  
Lower Control Arm

**CH2117**  
Lower Control Arm Bush

**CH2117**  
Lower Control Arm Bush



**CH2018**  
Lower Control Arm

**CH2116**  
Lower Control Arm Bush

**CH2019**  
Lower Control Arm

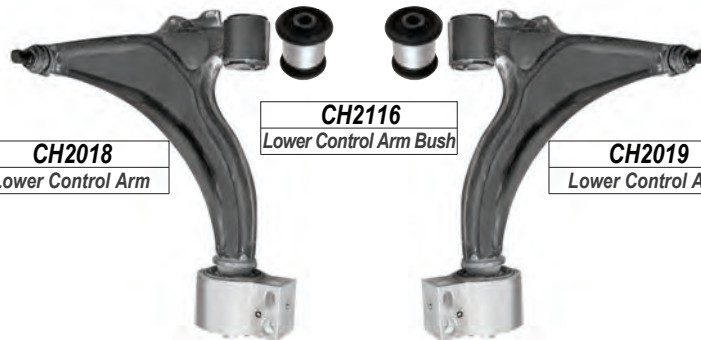

**CH2812**  
Shock Mounting



**CH2812**  
Shock Mounting



**CH2117**  
Lower Control Arm Bush

**CH2117**  
Lower Control Arm Bush



**CRUZE**

**REAR**

**CH2813**  
Shock Mounting



**CH2813**  
Shock Mounting



**LEFT**

**RIGHT**

**CHEVROLET**

OPTRA

FRONT

1.6.LS.1.8LT

Year

2004-

**CH1314**

Outer Tie Rod End Set  
(Ø13.2\*Ø15.1/M14\*1.5)



**CH1015**

Outer Tie Rod End  
(Ø13.2\*Ø15.1/M14\*1.5)



**CH1416**

Rack End  
(16\*1.5/14\*1.5/345)



**CH1016**

Outer Tie Rod End  
(Ø13.2\*Ø15.1/M14\*1.5)



**CH1517 / CH1518**

Link Stabilizer  
L=272



**CH2118**

Lower Control Arm Bush



**CH1915**

Lower Ball Joint  
(Ø18)



**CH1915**

Lower Ball Joint  
(Ø18)



**CH2020**

Lower Control Arm



**CH2021**

Lower Control Arm



**CH2814**

Shock Mounting



**CH2814**

Shock Mounting



**CH2119**

Lower Control Arm Bush



OPTRA

REAR

**CH1519**

Link Stabilizer  
L=217



**CH2815**

Shock Mounting



**CH2815**

Shock Mounting



LEFT

RIGHT

**CHEVROLET**

ORLANDO

FRONT

1.8

Year

2011-

**CH1014**  
Outer Tie Rod End  
(Ø13.1\*Ø18.1/M16\*1.5)

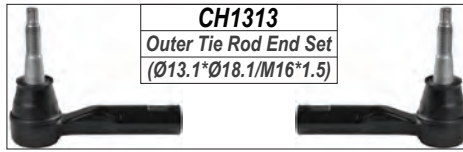

**CH1313**  
Outer Tie Rod End Set  
(Ø13.1\*Ø18.1/M16\*1.5)

**CH1417**  
Rack End  
(16\*1.5 /16\*1.5/310)



**CH1014**  
Outer Tie Rod End  
(Ø13.1\*Ø18.1/M16\*1.5)



**CH1516**  
Link Stabilizer  
L=304



**CH2018**  
Lower Control Arm



**CH2116**  
Lower Control Arm Bush



**CH2019**  
Lower Control Arm



**CH2117**  
Lower Control Arm Bush



**CH2117**  
Lower Control Arm Bush



**CH2812**  
Shock Mounting



**CH2812**  
Shock Mounting



ORLANDO

REAR

**CH2813**  
Shock Mounting



**CH2813**  
Shock Mounting



LEFT

RIGHT

**CHEVROLET**

**SONIC**

**FRONT**

**T300**

**Year**

**2011-**

**CH1012**  
Outer Tie Rod End  
(Ø13.55\*Ø16/M14\*1.5)

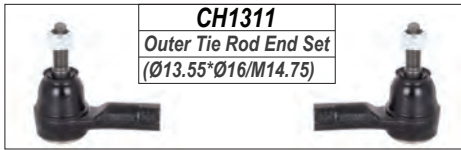

**CH1311**  
Outer Tie Rod End Set  
(Ø13.55\*Ø16/M14.75)

**CH1012**  
Outer Tie Rod End  
(Ø13.55\*Ø16/M14\*1.5)



**CH1411**  
Rack End  
(16\*1.5 /14\*1.5/328)



**OP1421**  
Rack End  
(14\*1.5/14\*1.5/334)



**CH1512**  
Link Stabilizer  
L=295



**CH1912**  
Lower Ball Joint  
(Ø14.9)



**CH2112**  
Lower Control Arm Bush



**CH1912**  
Lower Ball Joint  
(Ø14.9)



**CH2012**  
Lower Control Arm



**CH2013**  
Lower Control Arm



**CH2113**  
Lower Control Arm Bush



**CH2810**  
Shock Mounting



**CH2810**  
Shock Mounting



**LEFT**

**RIGHT**



**CHEVROLET**

**SPARK**

**FRONT**

**08 LS.LT.1.0 LS.LT**

*Year*

**2003-2009**

**CY1010**  
Outer Tie Rod End  
(Ø12.6\*Ø14.5/M12\*1.5)

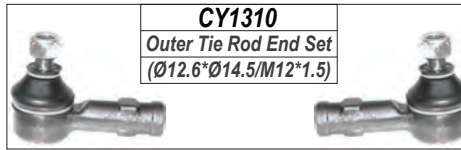

**CY1310**  
Outer Tie Rod End Set  
(Ø12.6\*Ø14.5/M12\*1.5)

**CY1410**  
Rack End  
(16\*1.5 /12\*1.5/250)

**CY1011**  
Outer Tie Rod End  
(Ø12.6\*Ø14.5/M12\*1.5)



**CY2010**  
Lower Control Arm



**CY2010**  
Lower Control Arm

**CH2810**  
Shock Mounting



**CH2810**  
Shock Mounting



**LEFT**

**RIGHT**

**CHEVROLET**

**SPARK**

**FRONT**

**M300**

*Year*

**2010-**

**CH1017**  
Outer Tie Rod End  
(Ø13.2\*Ø15.1/M12\*1.25)

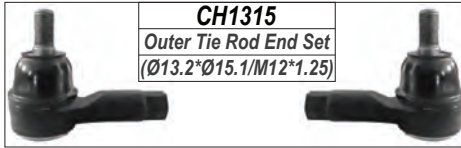

**CH1315**  
Outer Tie Rod End Set  
(Ø13.2\*Ø15.1/M12\*1.25)

**CH1017**  
Outer Tie Rod End  
(Ø13.2\*Ø15.1/M12\*1.25)

**CH1418**  
Rack End  
(14\*1.5 /12\*1.25/245)



**CH1520**  
Link Stabilizer  
L=235



**CH1916**  
Lower Ball Joint  
(Ø16)



**CH2120**  
Lower Control Arm Bush

**CH2022**  
Lower Control Arm



**CH2023**  
Lower Control Arm

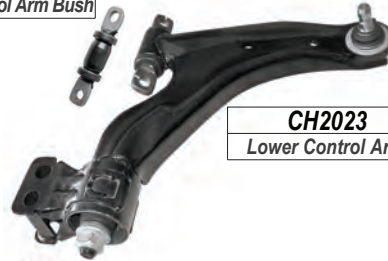

**CH1916**  
Lower Ball Joint  
(Ø16)



**CH2121**  
Lower Control Arm Bush



**LEFT**

**RIGHT**

**CHEVROLET**

UTILITY

FRONT

ALL

Year

2012-

**CH1018**  
Outer Tie Rod End  
(Ø13.2\*Ø15.1/M14\*1.5)

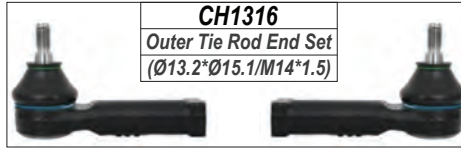

**CH1316**  
Outer Tie Rod End Set  
(Ø13.2\*Ø15.1/M14\*1.5)

**CH1419**  
Rack End  
(14\*1.5 /14\*1.5/274)

**CH1018**  
Outer Tie Rod End  
(Ø13.2\*Ø15.1/M14\*1.5)



**CH1910**  
Lower Ball Joint  
(Ø16)



**CH2122**  
Lower Control Arm Bush



**CH1910**  
Lower Ball Joint  
(Ø16)



**CH2024**  
Lower Control Arm



**CH2025**  
Lower Control Arm



LEFT

RIGHT

**CHRYSLER**

300C

FRONT

ALL

Year

2004-

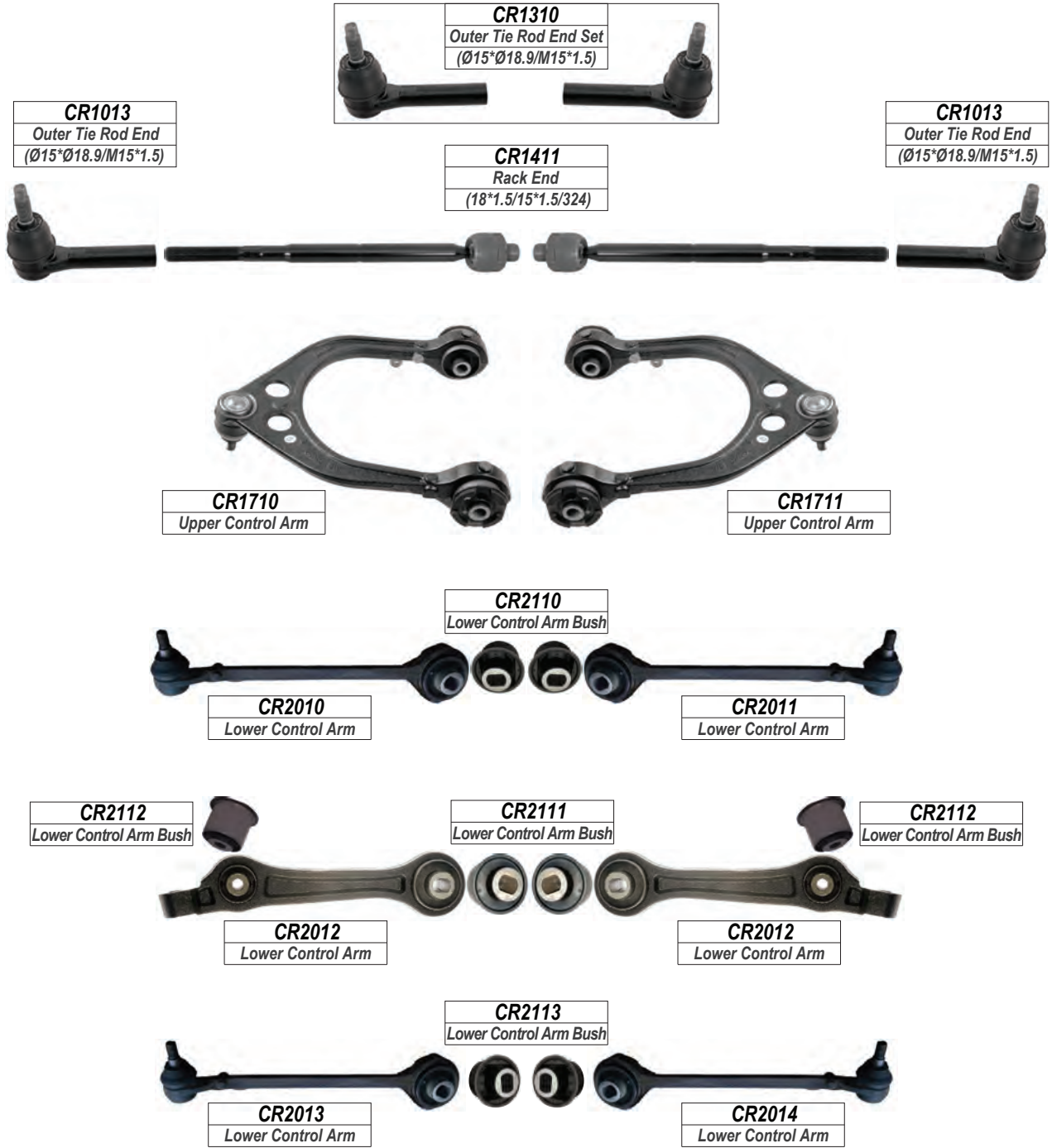

300C

REAR



LEFT

RIGHT

**CHRYSLER**

**GRAND VOYAGER FRONT  
VOYAGER**

Year

II (GS).2.0SE.2.4SE.2.5TD SE.

1997-2004

**CR1010**  
Outer Tie Rod End  
(Ø12.35\*Ø15.1/M14\*1.5)

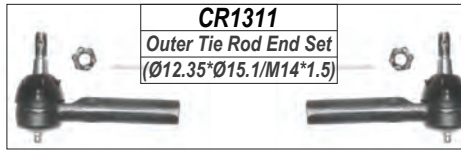

**CR1311**  
Outer Tie Rod End Set  
(Ø12.35\*Ø15.1/M14\*1.5)

**CR1410**  
Rack End  
(14\*1.5 /14\*1.5/296)

**CR1010**  
Outer Tie Rod End  
(Ø12.35\*Ø15.1/M14\*1.5)



**CR1511**  
Link Stabilizer  
L=310



**CR1910**  
Lower Ball Joint  
(Ø18)



**CR1910**  
Lower Ball Joint  
(Ø18)

**CR2015**  
Lower Control Arm

**CR2016**  
Lower Control Arm

**LEFT**

**RIGHT**



**CHRYSLER**

**GRAND VOYAGER FRONT  
VOYAGER**

Year

2001-2008

III

**CR1011**  
Outer Tie Rod End  
(Ø12.6\*Ø16/M14\*1.5)

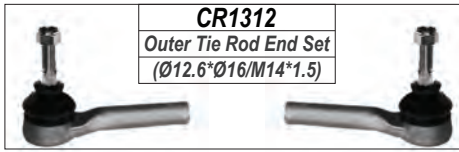

**CR1312**  
Outer Tie Rod End Set  
(Ø12.6\*Ø16/M14\*1.5)

**CR1410**  
Rack End  
(14\*1.5/14\*1.5/296)

**CR1011**  
Outer Tie Rod End  
(Ø12.6\*Ø16/M14\*1.5)



**CR1511**  
Link Stabilizer  
L=310



**CR1911**  
Lower Ball Joint  
(Ø13.5)



**CR2017**  
Lower Control Arm

**CR2018**  
Lower Control Arm

**CR1911**  
Lower Ball Joint  
(Ø13.5)



**LEFT**

**RIGHT**

**CHRYSLER**

NEON.PT CRUISER FRONT

ALL

Year

1994-2006

**CR1012**  
Outer Tie Rod End  
(Ø12.4\*Ø15.2/M14\*1.5)

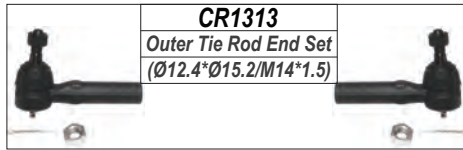

**CR1313**  
Outer Tie Rod End Set  
(Ø12.4\*Ø15.2/M14\*1.5)

**CR1410**  
Rack End  
(14\*1.5 /14\*1.5/296)

**CR1012**  
Outer Tie Rod End  
(Ø12.4\*Ø15.2/M14\*1.5)



**CR2114**  
Lower Control Arm Bush

**CR1910**  
Lower Ball Joint  
(Ø18)



**CR2019**  
Lower Control Arm

**CR2020**  
Lower Control Arm

**CR1910**  
Lower Ball Joint  
(Ø18)



**CR2115**  
Lower Control Arm Bush

**CR2810**  
Shock Mounting



**CR2810**  
Shock Mounting



NEON.PT CRUISER REAR

**CR1512**  
Link Stabilizer  
L=185.5



**CR2811**  
Shock Mounting



**CR2811**  
Shock Mounting



LEFT

RIGHT

**CHRYSLER**

*SEBRING*

*FRONT*

*ALL*

*Year*

*2007-2010*

<b>CR1513</b>
<i>Link Stabilizer</i>
<i>L=180.5</i>



**LEFT**

**RIGHT**

**CITROEN**

**BERLINGO**

**FRONT**

**ALL MODELS**

*Year*

**1999-2010**

**CI1013**  
Outer Tie Rod End  
(Ø12.1\*Ø15.85/M14\*1.5)

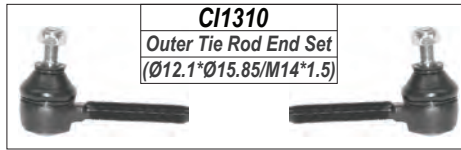

**CI1310**  
Outer Tie Rod End Set  
(Ø12.1\*Ø15.85/M14\*1.5)

**CI1013**  
Outer Tie Rod End  
(Ø12.1\*Ø15.85/M14\*1.5)

**CI1410**  
Rack End  
(12\*1.0 / 14\*1.5/262)



**CI1510**  
Link Stabilizer  
L=300



**CI1911**  
Lower Ball Joint  
(Ø18)

**CI2110**  
Lower Control Arm Bush

**CI1911**  
Lower Ball Joint  
(Ø18)

**CI2010**  
Lower Control Arm

**CI2011**  
Lower Control Arm



**CI2111**  
Lower Control Arm Bush

**CI2110**  
Lower Control Arm Bush

**PE1920**  
Lower Ball Joint  
(Ø16)

**PE2042**  
Lower Control Arm

**PE2043**  
Lower Control Arm

**PE1920**  
Lower Ball Joint  
(Ø16)



**CI2810**  
Shock Mounting

**CI2111**  
Lower Control Arm Bush

**CI2810**  
Shock Mounting



**LEFT**

**RIGHT**

**CITROEN**

**BERLINGO**

**FRONT**

**ALL MODELS**

*Year*

**2011-**

**CI1011**  
Outer Tie Rod End  
(Ø12\*Ø15/M14\*1.5)



**CI1311**  
Outer Tie Rod End Set  
(Ø12\*Ø15/M14\*1.5)

**CI1012**  
Outer Tie Rod End  
(Ø12\*Ø15/M14\*1.5)



**CI1411**  
Rack End  
(14\*1.5/14\*1.5/255)



**CI1511**  
Link Stabilizer  
L=334



**CI1912**  
Lower Ball Joint  
(Ø18)



**CI2112**  
Lower Control Arm Bush



**CI1912**  
Lower Ball Joint  
(Ø18)



**CI2012**  
Lower Control Arm



**CI2013**  
Lower Control Arm



**CI2113**  
Lower Control Arm Bush



**CI2811**  
Shock Mounting



**CI2811**  
Shock Mounting



**LEFT**

**RIGHT**



**CITROEN**

C1

FRONT

ALL MODELS

Year

2006-

**CI1013**  
Outer Tie Rod End  
(Ø12.5\*Ø15/M12\*1.25)

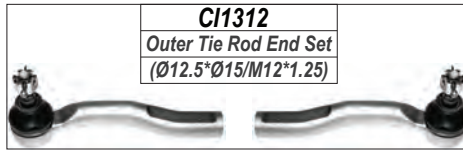

**CI1312**  
Outer Tie Rod End Set  
(Ø12.5\*Ø15/M12\*1.25)

**CI1014**  
Outer Tie Rod End  
(Ø12.5\*Ø15/M12\*1.25)



**CI1412**  
Rack End  
(14\*1.5/12\*1.25/222)



**CI1512**  
Link Stabilizer  
L=92



**CI2114**  
Lower Control Arm Bush



**CI1913**  
Lower Ball Joint  
(Ø13.5)



**CI1913**  
Lower Ball Joint  
(Ø13.5)



**CI2014**  
Lower Control Arm



**CI2015**  
Lower Control Arm

**CI2115**  
Lower Control Arm Bush



**CI2812**  
Shock Mounting



**CI2812**  
Shock Mounting



LEFT

RIGHT

**CITROEN**

C2

FRONT

ALL MODELS

Year

2003-2010

**CI1015**  
Outer Tie Rod End  
(Ø12.1\*Ø15.1/M14\*1.5)



**CI1313**  
Outer Tie Rod End Set  
(Ø12.1\*Ø15.1/M14\*1.5)

**CI1016**  
Outer Tie Rod End  
(Ø12.1\*Ø15.1/M14\*1.5)



**CI1413**  
Rack End  
(12\*1.0/14\*1.5/239)



**CI1513**  
Link Stabilizer  
L=335



**CI2116**  
Lower Control Arm Bush



**CI1914**  
Lower Ball Joint  
(Ø18)



**CI2016**  
Lower Control Arm

**CI2017**  
Lower Control Arm

**CI2117**  
Lower Control Arm Bush



**CI1914**  
Lower Ball Joint  
(Ø18)



**CI2813**  
Shock Mounting(Pin Mid)



**CI2813**  
Shock Mounting(Pin Mid)



**CI2814**  
Shock Mounting



**CI2814**  
Shock Mounting



LEFT

RIGHT

**CITROEN**

C3

FRONT

ALL MODELS

Year

2003-2011

**CI1015**  
Outer Tie Rod End  
(Ø12.1\*Ø15.1/M14\*1.5)

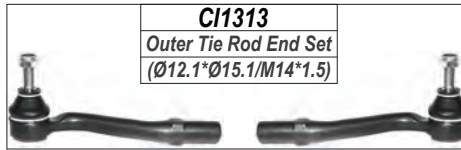

**CI1313**  
Outer Tie Rod End Set  
(Ø12.1\*Ø15.1/M14\*1.5)

**CI1016**  
Outer Tie Rod End  
(Ø12.1\*Ø15.1/M14\*1.5)



**CI1413**  
Rack End  
(12\*1.0/14\*1.5/245)



**CI1513**  
Link Stabilizer  
L=335



**CI2116**  
Lower Control Arm Bush



**CI1914**  
Lower Ball Joint  
(Ø18)



**CI2016**  
Lower Control Arm

**CI2017**  
Lower Control Arm

**CI1914**  
Lower Ball Joint  
(Ø18)



**CI2117**  
Lower Control Arm Bush



**CI2813**  
Shock Mounting(Pin Mid)



**CI2813**  
Shock Mounting(Pin Mid)



**CI2815**  
Shock Mounting



**CI2815**  
Shock Mounting



LEFT

RIGHT

**CITROEN**

C3

FRONT

ALL MODELS

Year

2010-

**CI1017**  
Outer Tie Rod End  
(Ø12.26\*Ø15.2/M14\*1.5)



**CI1314**  
Outer Tie Rod End Set  
(Ø12.26\*Ø15.2/M14\*1.5)

**CI1018**  
Outer Tie Rod End  
(Ø12.26\*Ø15.2/M14\*1.5)



**CI1414**  
Rack End  
(12\*1.0/14\*1.5/245)



**CI1513**  
Link Stabilizer  
L=335



**CI1514**  
Link Stabilizer  
L=335



**CI2118**  
Lower Control Arm Bush



**CI1915**  
Lower Ball Joint  
(Ø18)



**CI1915**  
Lower Ball Joint  
(Ø18)



**CI2018**  
Lower Control Arm



**CI2019**  
Lower Control Arm



**CI2119**  
Lower Control Arm Bush



**CI2815**  
Shock Mounting



**CI2815**  
Shock Mounting



LEFT

RIGHT

**CITROEN**

C4

FRONT

ALL MODELS

Year

2004-2010

**CI1019**  
Outer Tie Rod End  
(Ø12.1\*Ø15.85/M14\*1.5)

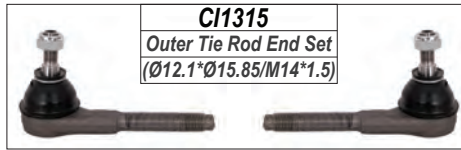

**CI1315**  
Outer Tie Rod End Set  
(Ø12.1\*Ø15.85/M14\*1.5)

**CI1415**  
Rack End  
(14\*1.5/14\*1.5/319)

**CI1020**  
Outer Tie Rod End  
(Ø12.1\*Ø15.85/M14\*1.5)



**CI1010**  
Outer Tie Rod End  
(Ø12.1\*Ø15.85/M14\*1.5)



**CI1010**  
Outer Tie Rod End  
(Ø12.1\*Ø15.85/M14\*1.5)



**CI1515**  
Link Stabilizer  
L=335



**CI2112**  
Lower Control Arm Bush



**CI1912**  
Lower Ball Joint  
(Ø15.7)



**CI2012**  
Lower Control Arm

**CI2013**  
Lower Control Arm

**CI1912**  
Lower Ball Joint  
(Ø15.7)



**CI2811**  
Shock Mounting



**CI2113**  
Lower Control Arm Bush



**CI2811**  
Shock Mounting



**CI2816**  
Shock Mounting



**CI2816**  
Shock Mounting



LEFT

RIGHT



**CITROEN**

C4

FRONT

ALL MODELS

Year

2010-

**CI1021**  
Outer Tie Rod End  
(Ø12.2\*Ø15.9/M16\*1.5)

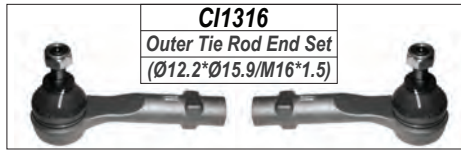

**CI1416**  
Rack End  
(14\*1.5/16\*1.5/312)

**CI1022**  
Outer Tie Rod End  
(Ø12.2\*Ø15.9/M16\*1.5)

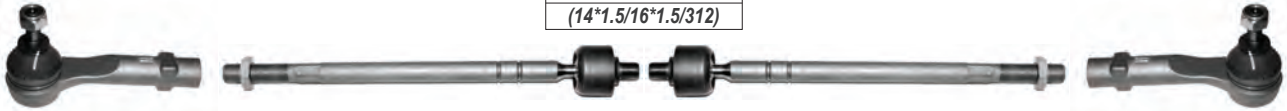

**CI1511**  
Link Stabilizer  
L=334



**CI1515**  
Link Stabilizer  
L=335



**CI2112**  
Lower Control Arm Bush

**CI1912**  
Lower Ball Joint  
(Ø15.7)



**CI2012**  
Lower Control Arm

**CI2013**  
Lower Control Arm

**CI1912**  
Lower Ball Joint  
(Ø15.7)



**CI2113**  
Lower Control Arm Bush



LEFT

RIGHT

**CITROEN**

**C4 AIRCROSS**

**FRONT**

**ALL MODELS**

*Year*

**2012-**

**CI1029**  
Outer Tie Rod End  
(Ø13.45\*Ø15.1/M14\*1.5)

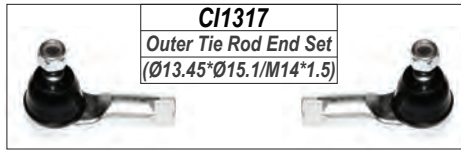

**CI1317**  
Outer Tie Rod End Set  
(Ø13.45\*Ø15.1/M14\*1.5)

**CI1029**  
Outer Tie Rod End  
(Ø13.45\*Ø15.1/M14\*1.5)



**CI1420**  
Rack End  
(14\*1.5/14\*1.5/341)



**CI1516**  
Link Stabilizer  
L=265



**CI2121**  
Lower Control Arm Bush



**CI1910**  
Lower Ball Joint  
(Ø20)



**CI2020**  
Lower Control Arm

**CI2021**  
Lower Control Arm

**CI1910**  
Lower Ball Joint  
(Ø20)



**CI2120**  
Lower Control Arm Bush



**C4 AIRCROSS**

**REAR**

**DO1511 / DO1512**  
Link Stabilizer  
L=80



**LEFT**

**RIGHT**

**CITROEN**

**C4**

**FRONT**

**PICASSO II**

*Year*

**2013-**

**CI1030**  
Outer Tie Rod End  
(Ø14.4\*Ø19/M14\*1.5)

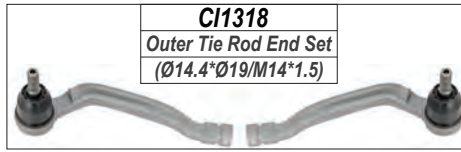

**CI1318**  
Outer Tie Rod End Set  
(Ø14.4\*Ø19/M14\*1.5)

**CI1421**  
Rack End  
(14\*1.5/14\*1.5/220)



**CI1031**  
Outer Tie Rod End  
(Ø14.4\*Ø19/M14\*1.5)



**CI2022**  
Lower Control Arm

**CI2023**  
Lower Control Arm

**LEFT**

**RIGHT**

**CITROEN**

C5

FRONT

DC.DE.RC.RE

Year

2001-2008

**CI1023**  
Outer Tie Rod End  
(Ø11.9\*Ø15.7/M16\*1.5)



**CI1319**  
Outer Tie Rod End Set  
(Ø11.9\*Ø15.7/M16\*1.5)

**CI1024**  
Outer Tie Rod End  
(Ø11.9\*Ø15.7/M16\*1.5)



**CI1417**  
Rack End  
(16\*1.5/16\*1.5/182)



**CI1517**  
Link Stabilizer  
L=320



**CI2122**  
Lower Control Arm Bush



**CI2123**  
Lower Control Arm Bush



**CI1916**  
Lower Ball Joint  
(Ø15.8)



**CI1916**  
Lower Ball Joint  
(Ø15.8)



**CI2024**  
Lower Control Arm



**CI2025**  
Lower Control Arm



LEFT

RIGHT

**CITROEN**

C5

FRONT

RD.TD

Year

2008-

**CI1025**  
Outer Tie Rod End  
(Ø14.8\*Ø17.9/M14\*1.5)

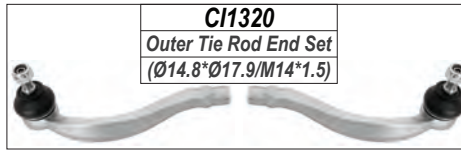

**CI1320**  
Outer Tie Rod End Set  
(Ø14.8\*Ø17.9/M14\*1.5)

**CI1026**  
Outer Tie Rod End  
(Ø14.8\*Ø17.9/M14\*1.5)



**CI1418**  
Rack End  
(16\*1.5/14\*1.5/129)



**CI1518 / CI1519**  
Link Stabilizer  
L=200

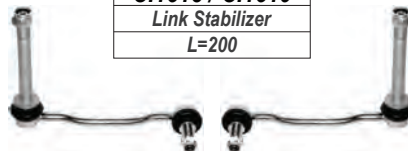

**CI1610**  
Upper Ball Joint  
(Ø18)



**CI1610**  
Upper Ball Joint  
(Ø18)



**CI2124**  
Lower Control Arm Bush



**CI2026**  
Lower Control Arm

**CI2027**  
Lower Control Arm

**CI1917**  
Lower Ball Joint



**CI1917**  
Lower Ball Joint



**CI2125**  
Lower Control Arm Bush



C5

REAR

**CI1520**  
Link Stabilizer  
L=141



LEFT

RIGHT



**CITROEN**

DS3

FRONT

ALL MODELS

Year

2010-2015

**CI1017**  
Outer Tie Rod End  
(Ø12.26\*Ø15.2/M14\*1.5)



**CI1314**  
Outer Tie Rod End Set  
(Ø12.26\*Ø15.2/M14\*1.5)

**CI1414**  
Rack End  
(12\*1.0/14\*1.5/245)



**CI1018**  
Outer Tie Rod End  
(Ø12.26\*Ø15.2/M14\*1.5)



**CI1513**  
Link Stabilizer  
L=335



**CI1514**  
Link Stabilizer  
L=335



**CI2118**  
Lower Control Arm Bush



**CI2119**  
Lower Control Arm Bush



**CI1915**  
Lower Ball Joint  
(Ø18)



**CI1915**  
Lower Ball Joint  
(Ø18)



**CI2018**  
Lower Control Arm



**CI2019**  
Lower Control Arm



LEFT

RIGHT

**CITROEN**

RELAY

FRONT

ALL MODELS

Year

2012-

**CI1027**  
Outer Tie Rod End  
(Ø16.65\*Ø21.4/M16\*1.5)



**CI1419**  
Rack End  
(16\*1.5/16\*1.5/260)

**CI1028**  
Outer Tie Rod End  
(Ø16.65\*Ø21.4/M16\*1.5)

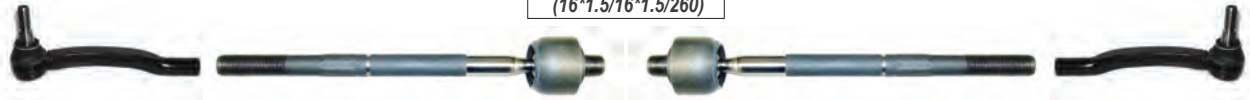

**CI1521**  
Link Stabilizer  
L=112



**CI2126**  
Lower Control Arm Bush

**CI1918**  
Lower Ball Joint  
(Ø20.55)



**CI2028**  
Lower Control Arm



**CI2029**  
Lower Control Arm

**CI1918**  
Lower Ball Joint  
(Ø20.55)



**CI2127**  
Lower Control Arm Bush



RELAY

REAR

**CI1522**  
Link Stabilizer  
L=100



LEFT

RIGHT

**CITROEN**

**XSARA PICASSO**

**FRONT**

**N68**

**Year**

**2001-**

**CI1010**  
Outer Tie Rod End  
(Ø12.1\*Ø15.85/M14\*1.5)

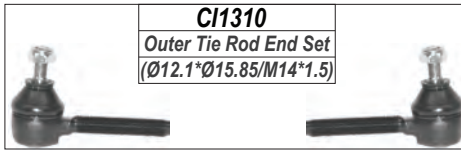

**CI1310**  
Outer Tie Rod End Set  
(Ø12.1\*Ø15.85/M14\*1.5)

**CI1010**  
Outer Tie Rod End  
(Ø12.1\*Ø15.85/M14\*1.5)

**CI1410**  
Rack End  
(12\*1.0 /14\*1.5/335)



**CI1422**  
Rack End  
(12\*1.0/14\*1.5/338)



**CI1510**  
Link Stabilizer  
L=300



**CI1911**  
Lower Ball Joint  
(Ø18)



**CI2110**  
Lower Control Arm Bush



**CI1911**  
Lower Ball Joint  
(Ø18)



**CI2010**  
Lower Control Arm



**CI2011**  
Lower Control Arm

**CI2111**  
Lower Control Arm Bush



**CI2110**  
Lower Control Arm Bush

**CI2030**  
Lower Control Arm

**CI2031**  
Lower Control Arm

**CI2810**  
Shock Mounting



**CI2810**  
Shock Mounting



**CI2111**  
Lower Control Arm Bush

**RELAY**

**REAR**

**CI2910**  
Axle Beam



**LEFT**

**RIGHT**

**CMC**

SESBUYILE

FRONT

2.4 4RB2

Year

2011-

**CM1010**  
Outer Tie Rod End  
(Ø12.6\*Ø14.5/M12\*1.5)

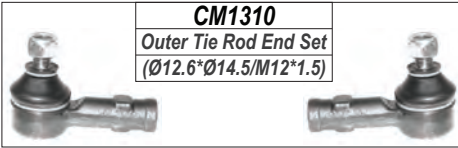

**CM1310**  
Outer Tie Rod End Set  
(Ø12.6\*Ø14.5/M12\*1.5)

**CA1411**  
Rack End  
(14\*1.5/15\*1.5/274)



**CM1010**  
Outer Tie Rod End  
(Ø12.6\*Ø14.5/M12\*1.5)



**CM1510**  
Link Stabilizer  
L=159.5



**CM1710**  
Upper Control Arm

**CM1711**  
Upper Control Arm

**CM1910**  
Lower Ball Joint  
(Ø17.25)



**CM2010**  
Lower Control Arm



**CM2011**  
Lower Control Arm

**CM1910**  
Lower Ball Joint  
(Ø17.25)



LEFT

RIGHT

**DAEWOO**

**CIELO.ESPERO.LANOS FRONT**

Year

**ALL MODELS**

**1996-2004**

**DA1010**  
Outer Tie Rod End  
(Ø13\*Ø15.3/M16\*1.5)

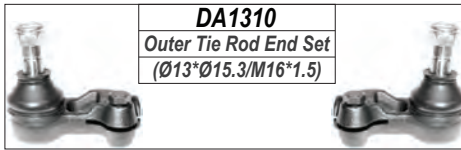

**DA1310**  
Outer Tie Rod End Set  
(Ø13\*Ø15.3/M16\*1.5)

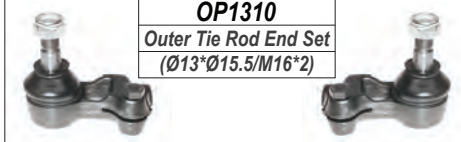

**OP1310**  
Outer Tie Rod End Set  
(Ø13\*Ø15.5/M16\*2)

**DA1011**  
Outer Tie Rod End  
(Ø13\*Ø15.3/M16\*1.5)



**OP1016**  
Outer Tie Rod End  
(Ø13\*Ø15.5/M16\*2)



**DA2210**  
Rack End



**OP1017**  
Outer Tie Rod End  
(Ø13\*Ø15.5/M16\*2)



**DA2210 / DA2211**  
Center Rod

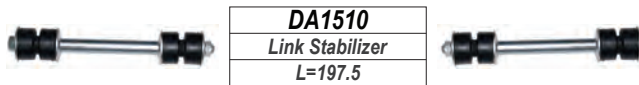

**DA1510**  
Link Stabilizer  
L=197.5

**DA2111**  
Lower Control Arm Bush

**DA1914**  
Lower Ball Joint  
(Ø13.3)



**DA1914**  
Lower Ball Joint  
(Ø13.3)

**DA2010**  
Lower Control Arm

**DA2011**  
Lower Control Arm

**DA2811**  
Shock Mounting



**DA2811**  
Shock Mounting



**DA2810**  
Shock Mounting



**DA2810**  
Shock Mounting



**DA2110**  
Lower Control Arm Bush

**DA2910**  
Bush



**CIELO.ESPERO.LANOS REAR**

**LEFT**

**RIGHT**



**DAEWOO**

**LEGANZA**

**FRONT**

**ALL MODELS**

*Year*

**2001-2004**

**DA1012**  
Outer Tie Rod End  
(Ø13.3\*Ø15.35/M14\*1.5)

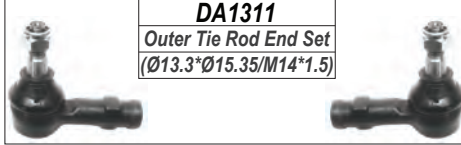

**DA1311**  
Outer Tie Rod End Set  
(Ø13.3\*Ø15.35/M14\*1.5)

**DA1411**  
Rack End  
(16\*1.5 /14\*1.5/374.1)

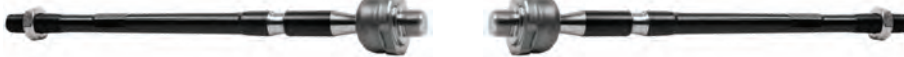

**DA1012**  
Outer Tie Rod End  
(Ø13.3\*Ø15.35/M14\*1.5)



**DA1511 / DA1512**  
Link Stabilizer  
L=80



**DA1915**  
Lower Ball Joint  
(Ø18)



**DA1915**  
Lower Ball Joint  
(Ø18)



**LEFT**

**RIGHT**

**DAEWOO**

**MATIZ**

**FRONT**

**ALL MODELS**

*Year*

**1999-2004**

**CY1010**  
Outer Tie Rod End  
(Ø12.6\*Ø14.5/M12\*1.5)

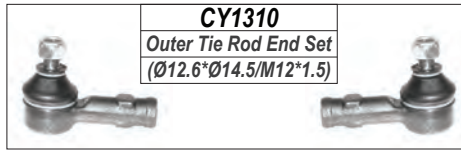

**CY1310**  
Outer Tie Rod End Set  
(Ø12.6\*Ø14.5/M12\*1.5)

**DA1410**  
Rack End  
(16\*1.5 /12\*1.5/250)



**CY1010**  
Outer Tie Rod End  
(Ø12.6\*Ø14.5/M12\*1.5)



**CY2010**  
Lower Control Arm



**CY2010**  
Lower Control Arm

**LEFT**

**RIGHT**

**DAEWOO**

**NUBIRA**

**FRONT**

*Year*

**NUBIRA 1.NUBIRA 2**

**1997-2004**

**DA1012**  
Outer Tie Rod End  
(Ø13.3\*Ø15.3/M14\*1.5)

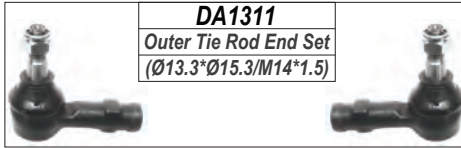

**DA1311**  
Outer Tie Rod End Set  
(Ø13.3\*Ø15.3/M14\*1.5)

**CH1416**  
Rack End  
(16\*1.5/14\*1.5/345)



**DA1012**  
Outer Tie Rod End  
(Ø13.3\*Ø15.3/M14\*1.5)



**DA1513**  
Link Stabilizer  
L=266



**CH1510**  
Link Stabilizer  
L=261



**DA1916**  
Lower Ball Joint  
(Ø16)



**DA2012**  
Lower Control Arm

**DA2013**  
Lower Control Arm

**DA1916**  
Lower Ball Joint  
(Ø16)



**DA2812**  
Shock Mounting



**DA2812**  
Shock Mounting



**NUBIRA**

**REAR**

**CH1511**  
Link Stabilizer  
L=247



**LEFT**

**RIGHT**

**DAEWOO**

**TACUMA**

**FRONT**

**ALL MODELS**

*Year*

**2001-**

<b>DA1013</b>
Outer Tie Rod End
(Ø13.3*Ø15.1/M14*1.5)

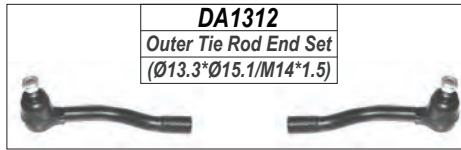

<b>DA1014</b>
Outer Tie Rod End
(Ø13.3*Ø15.1/M14*1.5)



<b>DA1410</b>
Rack End
(16*1.5 / 14*1.5 / 240)



<b>CH1510</b>
Link Stabilizer
L=261



<b>DA1917</b>
Lower Ball Joint
(Ø16)



<b>DA1917</b>
Lower Ball Joint
(Ø16)



<b>CH2118</b>
Bush



**TACUMA**

**REAR**

<b>CH1511</b>
Link Stabilizer
L=247



**LEFT**

**RIGHT**

**DAIHATSU**

CHARADE

FRONT

G11

Year

1983-1985

**DH1010**  
Outer Tie Rod End  
(Ø11.76\*Ø14.1/M12\*1.25)



**DH1310**  
Outer Tie Rod End Set  
(Ø11.76\*Ø14.1/M12\*1.25)

**DH1410**  
Rack End  
(11\*1.5 /12\*1.25/224)



**DH1011**  
Outer Tie Rod End  
(Ø11.76\*Ø14.1/M12\*1.25)



**DH2010**  
Lower Control Arm



**DH2010**  
Lower Control Arm



**DH2011**  
Lower Control Arm  
Import Only



**DH2012**  
Lower Control Arm  
Import Only

**LEFT**

**RIGHT**



**DAIHATSU**

CHARADE

FRONT

ALL MODELS

Year

2003-

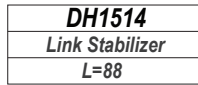
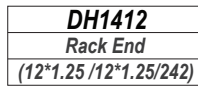
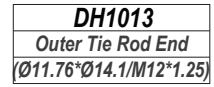
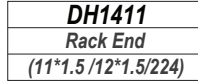

LEFT

RIGHT

**DAIHATSU**

CUORE/MOVE

FRONT

847

Year

1997-

**DH1012**  
Outer Tie Rod End  
(Ø11.76\*Ø14.1/M12\*1.25)



**DH1311**  
Outer Tie Rod End Set  
(Ø11.76\*Ø14.1/M12\*1.25)

**DH1013**  
Outer Tie Rod End  
(Ø11.76\*Ø14.1/M12\*1.25)



**DH1411**  
Rack End  
(11\*1.5 /12\*1.5/224)



**DH2013**  
Lower Control Arm



**DH2014**  
Lower Control Arm

CUORE/MOVE

REAR

**DH1510**  
Link Stabilizer  
L=55.5



LEFT

RIGHT

**DAIHATSU**

**SIRION**

**FRONT**

*Year*

**1998-2003**



<b>DH1411</b> Rack End (11*1.5 / 12*1.25/224)
---

<b>DH1014</b> Outer Tie Rod End (Ø12*Ø14/M12*1.25)
--



<b>DH1015</b> Outer Tie Rod End (Ø12*Ø14/M12*1.25)
--



<b>DH1412</b> Rack End (12*1.25 / 12*1.25/242)
--



<b>DH2013</b> Lower Control Arm
------------------------------------



<b>DH2014</b> Lower Control Arm
------------------------------------

**LEFT**

**RIGHT**

**DAIHATSU**

**SIRION**

**FRONT**

Year

2003-2009

II

**DH1010**  
Outer Tie Rod End  
(Ø11.76\*Ø14.1/M12\*1.25)



**DH1310**  
Outer Tie Rod End Set  
(Ø11.76\*Ø14.1/M12\*1.25)

**DH1011**  
Outer Tie Rod End  
(Ø11.76\*Ø14.1/M12\*1.25)



**DH1410**  
Rack End  
(11\*1.5 / 12\*1.25/244)



**DH1413**  
Rack End  
(14\*1.5/12\*1.25/242)



**DH1511 / DH1512**  
Link Stabilizer  
L=49.5



**DH2113**  
Lower Control Arm Bush



**DH2015**  
Lower Control Arm

**DH2016**  
Lower Control Arm

**DH2112**  
Lower Control Arm Bush



**LEFT**

**RIGHT**

**DAIHATSU**

TERIOS

FRONT

Year

1997-2005

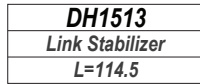
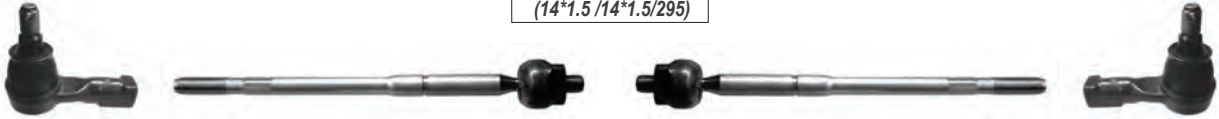
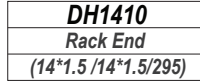
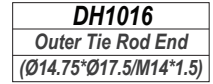
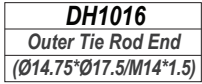

**DH2017**  
Lower Control Arm



**DH2018**  
Lower Control Arm

**LEFT**

**RIGHT**



**DAIHATSU**

TERIOS

FRONT

II

Year

2005-

**DH1017**  
Outer Tie Rod End  
(Ø14.75\*Ø17.5/M14\*1.5)

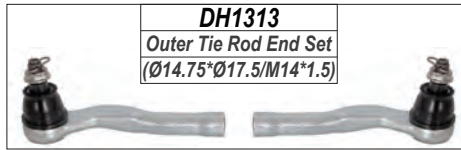

**DH1313**  
Outer Tie Rod End Set  
(Ø14.75\*Ø17.5/M14\*1.5)

**DH1018**  
Outer Tie Rod End  
(Ø14.75\*Ø17.5/M14\*1.5)



**DH1414**  
Rack End  
(14\*1.5 / 14\*1.5/295)



**DH1513**  
Link Stabilizer  
L=114.5



**DH2111**  
Lower Control Arm Bush



**DH1910**  
Lower Ball Joint  
(Ø18.1)



**DH2019**  
Lower Control Arm

**DH2020**  
Lower Control Arm

**DH1910**  
Lower Ball Joint  
(Ø18.1)



**DH2110**  
Lower Control Arm Bush



LEFT

RIGHT

**DATSUN**

GO

FRONT

ALL MODELS

Year

2015-

**DT1010**  
Outer Tie Rod End  
(Ø11.7\*Ø14.6/M12\*1.25)



**DT1310**  
Outer Tie Rod End Set  
(Ø11.7\*Ø14.6/M12\*1.25)

**DT1410**  
Rack End  
(14\*1.5/12\*1.25/228)



**DT1011**  
Outer Tie Rod End  
(Ø11.7\*Ø14.6/M12\*1.25)



**DT2110**  
Lower Control Arm Bush



**DT1910**  
Lower Ball Joint  
(Ø16)



**DT2010**  
Lower Control Arm

**DT2011**  
Lower Control Arm

**DT1910**  
Lower Ball Joint  
(Ø16)



**DT2111**  
Lower Control Arm Bush



**DT2810**  
Shock Mounting



LEFT

RIGHT

**DODGE**

**CALIBER**

**FRONT**

**ALL MODELS**

*Year*

**2006-**

**CR1011**  
Outer Tie Rod End  
(Ø12.6\*Ø16/M14\*1.5)

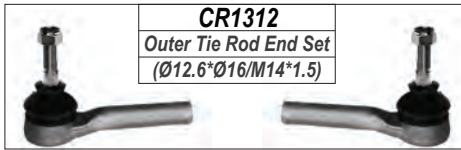

**CR1312**  
Outer Tie Rod End Set  
(Ø12.6\*Ø16/M14\*1.5)

**CR1011**  
Outer Tie Rod End  
(Ø12.6\*Ø16/M14\*1.5)

**DO1410**  
Rack End  
(14\*1.5 /14\*1.5/298)



**DO1510**  
Link Stabilizer  
L=266



**CR1513**  
Link Stabilizer  
L=180.5



**JE2111**  
Lower Control Arm Bush

**DO1911**  
Lower Ball Joint  
(Ø20)



**JE2012**  
Lower Control Arm

**JE2013**  
Lower Control Arm

**DO1911**  
Lower Ball Joint  
(Ø20)



**JE2110**  
Lower Control Arm Bush



**DO2810**  
Shock Mounting



**DO2810**  
Shock Mounting



**CALIBER**

**REAR**

**DO1511 / DO1512**  
Link Stabilizer  
L=80



**LEFT**

**RIGHT**

**DODGE**

JOURNEY

FRONT

ALL MODELS

Year

2008-

**CR1011**  
Outer Tie Rod End  
(Ø12.6\*Ø16/M14\*1.5)

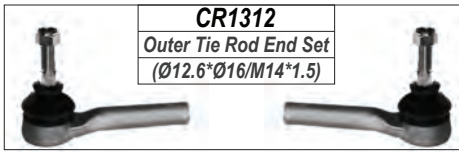

**CR1312**  
Outer Tie Rod End Set  
(Ø12.6\*Ø16/M14\*1.5)

**DO1410**  
Rack End  
(14\*1.5 /14\*1.5/298)



**CR1011**  
Outer Tie Rod End  
(Ø12.6\*Ø16/M14\*1.5)



**DO1510**  
Link Stabilizer  
L=266



**DO2111**  
Lower Control Arm Bush



**DO1910**  
Lower Ball Joint  
(Ø15.8)



**DO2010**  
Lower Control Arm

**DO2011**  
Lower Control Arm

**DO1910**  
Lower Ball Joint  
(Ø15.8)



**DO2811**  
Shock Mounting



**DO2110**  
Lower Control Arm Bush



**DO2811**  
Shock Mounting



JOURNEY

REAR

**DO1511 / DO1512**  
Link Stabilizer  
L=80



**DO2610**  
Lateral Link(Upper)



**DO2611**  
Lateral Link(Lower)



LEFT

RIGHT

**DODGE**

**NITRO**

**FRONT**

**ALL MODELS**

*Year*

**2007-**

**DO1010**  
Outer Tie Rod End  
(Ø15\*Ø18.9/M16\*1.5)



**DO1310**  
Outer Tie Rod End Set  
(Ø15\*Ø18.9/M16\*1.5)

**DO1411**  
Rack End  
(18\*1.5 / 16\*1.5/285)

**DO1011**  
Outer Tie Rod End  
(Ø15\*Ø18.9/M16\*1.5)



**CR1513**  
Link Stabilizer  
L=180.5



**CR1514**  
Link Stabilizer  
L=270



**DO1912**  
Lower Ball Joint  
(Ø17.3)



**DO2012**  
Lower Control Arm

**DO2013**  
Lower Control Arm

**DO1912**  
Lower Ball Joint  
(Ø17.3)



**LEFT**

**RIGHT**



**FIAT**

500

FRONT

C

Year

2007-

**FI1010**  
Outer Tie Rod End  
(Ø11.3\*Ø13.71/M12\*1.5)

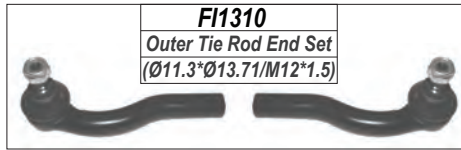

**FI1310**  
Outer Tie Rod End Set  
(Ø11.3\*Ø13.71/M12\*1.5)

**FI1011**  
Outer Tie Rod End  
(Ø11.3\*Ø13.71/M12\*1.5)



**FI1410**  
Rack End  
(14\*1.5/12\*1.5/255)



**FI1510**  
Link Stabilizer  
L=287



**FI2110**  
Lower Control Arm Bush



**FI2010**  
Lower Control Arm

**FI2011**  
Lower Control Arm

**FI2111**  
Lower Control Arm Bush



**FI2810**  
Shock Mounting



**FI2810**  
Shock Mounting



**LEFT**

**RIGHT**

**FIAT**

**500L**

**FRONT**

**ALL MODELS**

**Year**

**2008-2015**

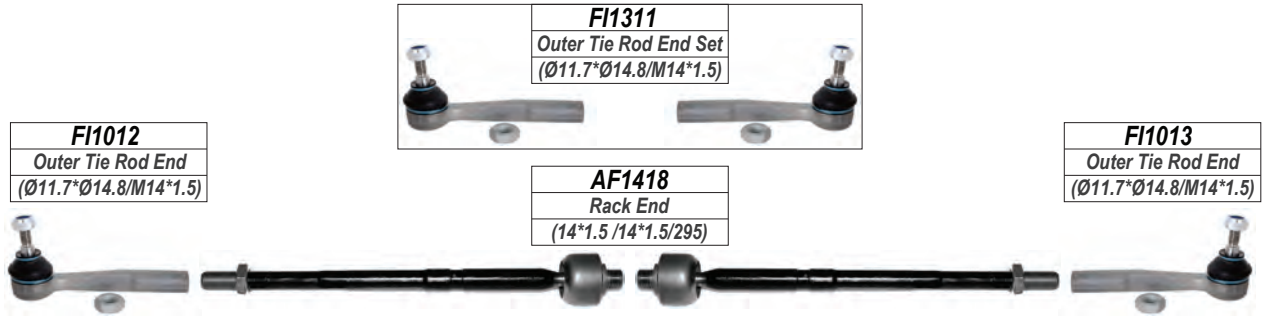

**LEFT**

**RIGHT**

**FIAT**

**500X**

**FRONT**

**ALL MODELS**

**Year**

**2015-**

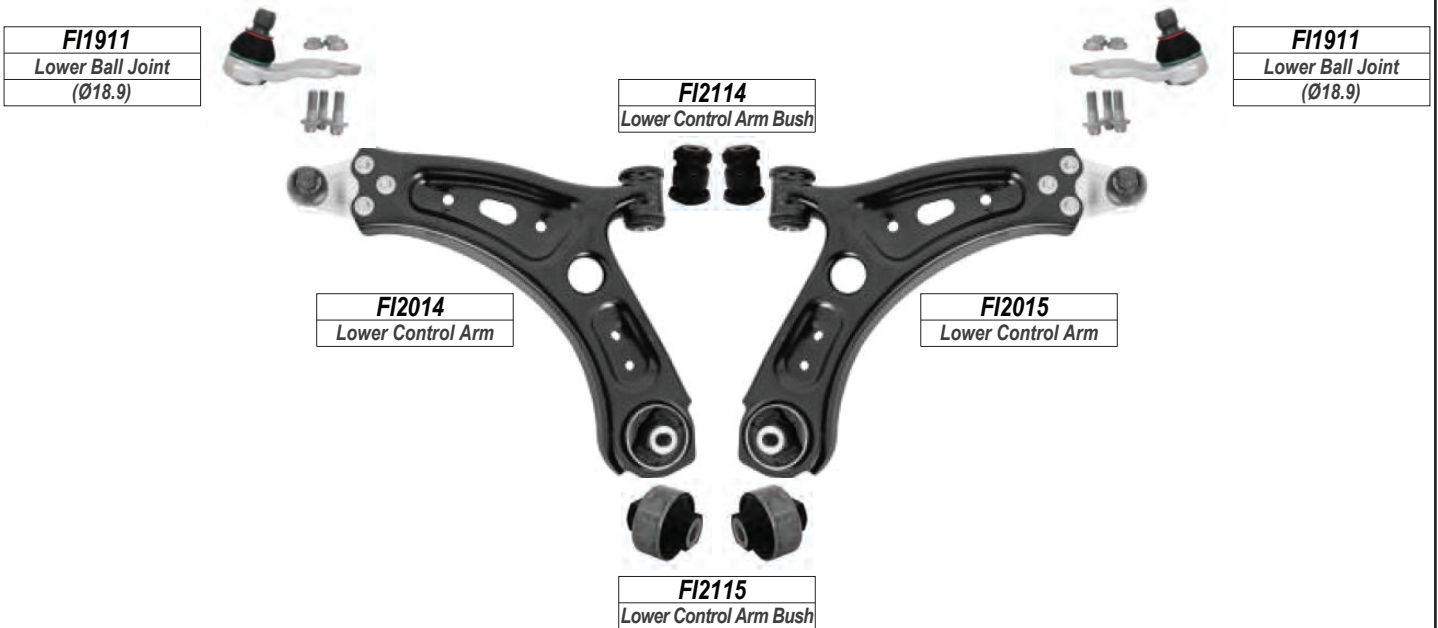
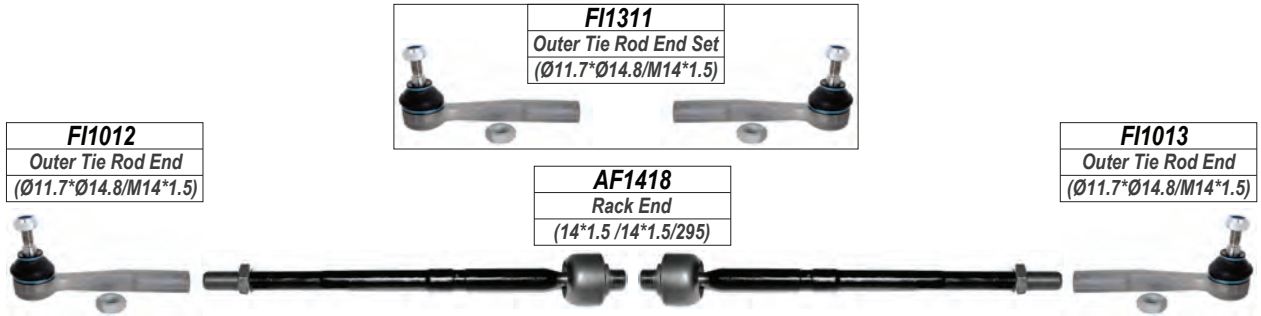

**LEFT**

**RIGHT**

**FIAT**

**BRAVO I / II**

**FRONT**

**ALL MODELS**

**Year**

**2006-**

**FI1014**  
Outer Tie Rod End  
(Ø11.72\*Ø14.8/M14\*1.5)

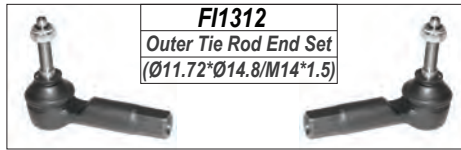

**FI1312**  
Outer Tie Rod End Set  
(Ø11.72\*Ø14.8/M14\*1.5)

**FI1411**  
Rack End  
(14\*1.5 / 14\*1.5/311)

**FI1014**  
Outer Tie Rod End  
(Ø11.72\*Ø14.8/M14\*1.5)



**FI1912**  
Lower Ball Joint  
(Ø17)



**FI2116**  
Lower Control Arm Bush



**FI1912**  
Lower Ball Joint  
(Ø17)



**FI2016**  
Lower Control Arm



**FI2017**  
Lower Control Arm

**FI2117**  
Lower Control Arm Bush



**FI2116**  
Lower Control Arm Bush



**FI2018**  
Lower Control Arm  
Sheet Metal (1.9 Mjet)



**FI2019**  
Lower Control Arm  
Sheet Metal (1.9 Mjet)

**FI2117**  
Lower Control Arm Bush



**LEFT**

**RIGHT**

**FIAT**

**DOBLO**

**FRONT**

**ALL MODELS**

**Year**

**2000-**

**FI1012**  
Outer Tie Rod End  
(Ø11.7\*Ø14.8/M14\*1.5)

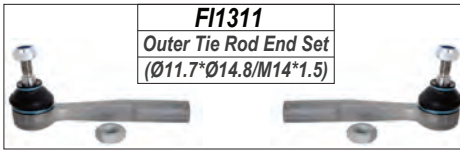

**FI1412**  
Rack End  
(16\*1.5 /14\*1.5/328)

**FI1012**  
Outer Tie Rod End  
(Ø11.7\*Ø14.8/M14\*1.5)



**FI1413**  
Rack End  
(16\*1.5 /14\*1.5/292)

**FI1016**  
Outer Tie Rod End  
(Ø12\*Ø13.6/M14\*1.5)



**FI1512**  
Link Stabilizer  
L=132

**FI1913**  
Lower Ball Joint  
(Ø13.6)

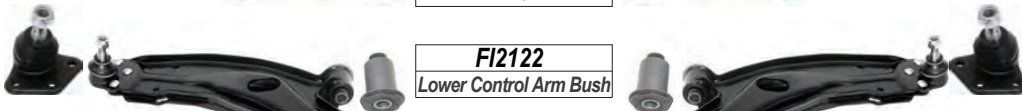

**FI2122**  
Lower Control Arm Bush

**FI1913**  
Lower Ball Joint  
(Ø13.6)

**FI2020**  
Lower Control Arm

**FI2021**  
Lower Control Arm



**FI2120 / FI2121**  
Lower Control Arm Bush



**FI2122**  
Lower Control Arm Bush

**FI2022**  
Lower Control Arm

**FI2023**  
Lower Control Arm



**FI2120 / FI2121**  
Lower Control Arm Bush

**FI2815**  
Shock Mounting



**FI2024**  
Lower Control Arm



**FI2122**  
Lower Control Arm Bush

**FI2122**  
Lower Control Arm Bush

**FI2025**  
Lower Control Arm



**FI2816**  
Shock Mounting



**FI2118 / FI2119**  
Lower Control Arm Bush

**LEFT**

**RIGHT**



**FIAT**

**DOBLO**

**FRONT**

**ALL MODELS**

**Year**

**2010-**

**FI1017**  
Outer Tie Rod End  
(Ø11.75\*Ø14.1/M14\*1.5)

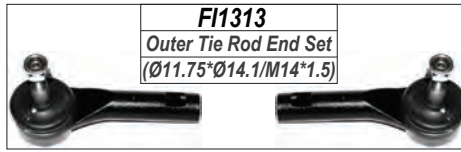

**FI1414**  
Rack End  
(18\*1.5 /14\*1.5/299)

**FI1018**  
Outer Tie Rod End  
(Ø11.75\*Ø14.1/M14\*1.5)



**FI1513**  
Link Stabilizer  
L=297



**FI1910**  
Lower Ball Joint  
(Ø18)



**FI2026**  
Lower Control Arm



**FI2027**  
Lower Control Arm



**FI1910**  
Lower Ball Joint  
(Ø18)

**AF2124**  
Lower Control Arm Bush



**LEFT**

**RIGHT**

**FIAT**

**DUCATO**

**FRONT**

**14Q.18Q**

*Year*

**2002-2006**

**FI1019**  
Outer Tie Rod End  
(Ø16.65\*Ø21.35/M16\*1.5)

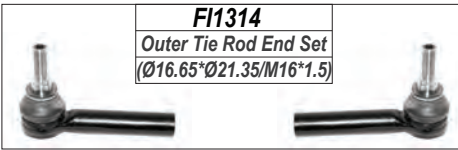

**FI1314**  
Outer Tie Rod End Set  
(Ø16.65\*Ø21.35/M16\*1.5)

**FI1019**  
Outer Tie Rod End  
(Ø16.65\*Ø21.35/M16\*1.5)

**FI1415**  
Rack End  
(16\*1.5/16\*1.5/317)



**FI1514**  
Link Stabilizer  
L=134



**FI2123**  
Lower Control Arm Bush

**FI1914**  
Lower Ball Joint(14Q)  
(Ø16.65)



**FI1914**  
Lower Ball Joint(14Q)  
(Ø16.65)

**FI2028**  
Lower Control Arm(14Q)

**FI2029**  
Lower Control Arm(14Q)

**FI2124**  
Lower Control Arm Bush

**FI1915**  
Lower Ball Joint(18Q)  
(Ø19.8)

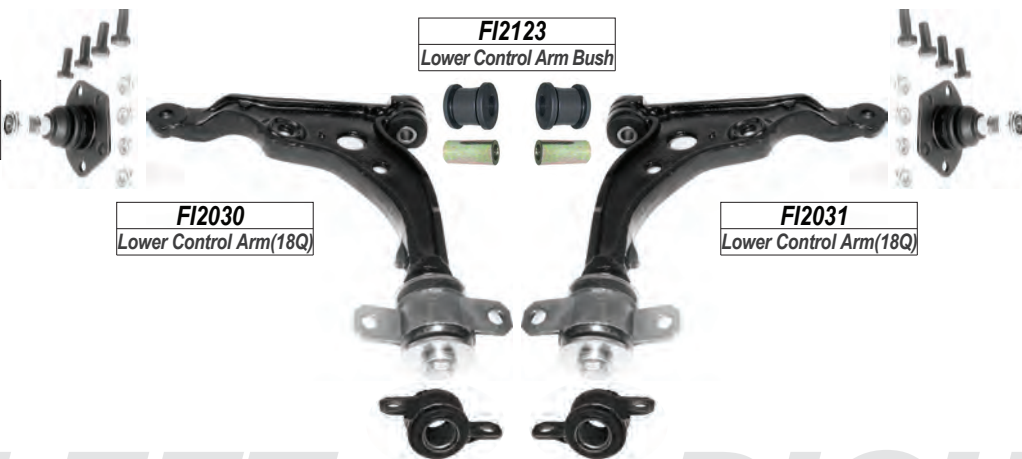

**FI1915**  
Lower Ball Joint(18Q)  
(Ø19.8)

**FI2030**  
Lower Control Arm(18Q)

**FI2031**  
Lower Control Arm(18Q)

**FI2124**  
Lower Control Arm Bush

**LEFT**

**RIGHT**

**FIAT**

**DUCATO**

**FRONT**

**15Q.17Q.17H.20Q**

**Year**

**2006-**

**CI1027**  
Outer Tie Rod End  
(Ø16.65\*Ø21.4/M16\*1.5)

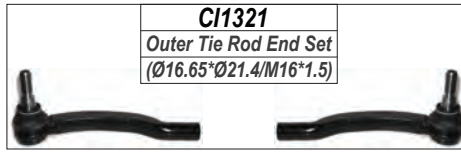

**CI1321**  
Outer Tie Rod End Set  
(Ø16.65\*Ø21.4/M16\*1.5)

**CI1419**  
Rack End  
(16\*1.5/16\*1.5/260)

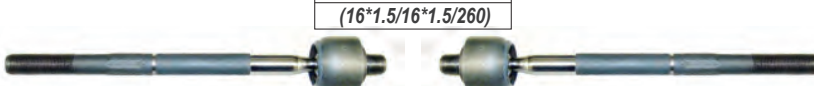

**CI1028**  
Outer Tie Rod End  
(Ø16.65\*Ø21.4/M16\*1.5)



**CI1521**  
Link Stabilizer  
L=112



**CI2126**  
Lower Control Arm Bush



**CI1918**  
Lower Ball Joint  
(Ø20.55)



**CI2028**  
Lower Control Arm

**CI2029**  
Lower Control Arm

**CI1918**  
Lower Ball Joint  
(Ø20.55)



**CI2127**  
Lower Control Arm Bush

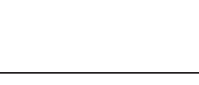

**DUCATO**

**REAR**

**CI1522**  
Link Stabilizer  
L=100



**LEFT**

**RIGHT**

**FIAT**

**FIORINO-LINEA-QUBO FRONT**

**ALL MODELS**

*Year*

**2008-**

**AF1026**  
Outer Tie Rod End  
(Ø11.8\*Ø14.8/M14\*1.5)

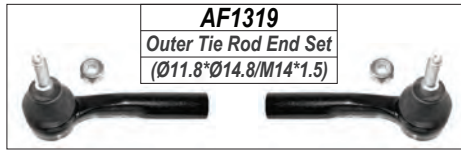

**AF1319**  
Outer Tie Rod End Set  
(Ø11.8\*Ø14.8/M14\*1.5)

**F11416**  
Rack End  
(14\*1.5 / 14\*1.5/267)

**AF1027**  
Outer Tie Rod End  
(Ø11.8\*Ø14.8/M14\*1.5)



**F11515**  
Link Stabilizer  
L=290



**AF2122**  
Lower Control Arm Bush



**AF1913**  
Lower Ball Joint  
(Ø20.55)



**AF1913**  
Lower Ball Joint  
(Ø20.55)



**AF2026**  
Lower Control Arm



**AF2027**  
Lower Control Arm

**AF2124**  
Lower Control Arm Bush



**F12817**  
Shock Mounting



**F12818**  
Shock Mounting



**LEFT**

**RIGHT**

**FIAT**

**MULTIPLA**

**FRONT**

**ALL MODELS**

*Year*

**1999-2007**

**AF1012**  
Outer Tie Rod End  
(Ø12\*Ø13.5/M14\*1.5)

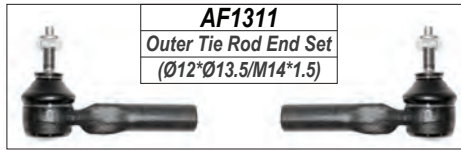

**AF1311**  
Outer Tie Rod End Set  
(Ø12\*Ø13.5/M14\*1.5)

**AF1012**  
Outer Tie Rod End  
(Ø12\*Ø13.5/M14\*1.5)



**F11417**  
Rack End  
(14\*1.5/14\*1.5/301)



**F11516**  
Link Stabilizer  
L=274.5



**FI2125 / FI2126**  
Lower Control Arm Bush



**FI2032**  
Lower Control Arm

**FI2033**  
Lower Control Arm

**AF2115 / AF2116**  
Lower Control Arm Bush

**LEFT**

**RIGHT**



**FIAT**

**PALIO / SIENA**

**FRONT**

**ALL MODELS**

**Year**

**1999-2006**

**FI1015**  
Outer Tie Rod End  
(Ø12\*Ø13.6/M14\*1.5)

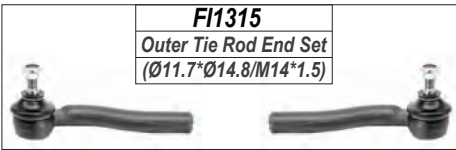

**FI1315**  
Outer Tie Rod End Set  
(Ø11.7\*Ø14.8/M14\*1.5)

**FI1016**  
Outer Tie Rod End  
(Ø12\*Ø13.6/M14\*1.5)



**FI1418**  
Rack End  
(16\*1.5/14\*1.5/286)



**FI1419**  
Rack End  
(14\*1.5/14\*1.5/292)



**FI1420**  
Rack End  
(16\*1.5/14\*1.5/300)



**FI1913**  
Lower Ball Joint  
(Ø13.6)



**FI1913**  
Lower Ball Joint  
(Ø13.6)



**FI2122**  
Lower Control Arm Bush

**FI2034**  
Lower Control Arm  
Man Steerin 00-02



**FI2035**  
Lower Control Arm  
Man Steerin 00-02



**FI2127 / FI2128**  
Lower Control Arm Bush

**FI1916**  
Lower Ball Joint  
(Ø15)



**FI2122**  
Lower Control Arm Bush



**FI1916**  
Lower Ball Joint  
(Ø15)



**FI2036**  
Lower Control Arm  
Pow Steering 00-02



**FI2037**  
Lower Control Arm  
Pow Steering 00-02



**FI2129 / FI2130**  
Lower Control Arm Bush



**FI1917**  
Lower Ball Joint  
(Ø13.1)



**FI1917**  
Lower Ball Joint  
(Ø13.1)



**FI2038**  
Lower Control Arm  
Pow Steering 02-



**FI2122**  
Lower Control Arm Bush



**FI2039**  
Lower Control Arm  
Pow Steering 02-



**FI2815**  
Shock Mounting



**FI2816**  
Shock Mounting



**FI2129 / FI2130**  
Lower Control Arm Bush



**LEFT**

**RIGHT**

**FIAT**

**PANDA**

**FRONT**

**ALL MODELS**

*Year*

**2003-**

**FI1010**  
Outer Tie Rod End  
(Ø11.3\*Ø13.71/M12\*1.5)

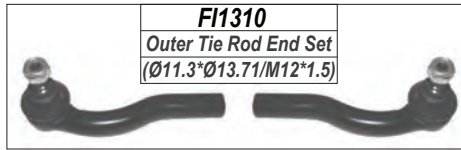

**FI1310**  
Outer Tie Rod End Set  
(Ø11.3\*Ø13.71/M12\*1.5)

**FI1011**  
Outer Tie Rod End  
(Ø11.3\*Ø13.71/M12\*1.5)



**FI1421**  
Rack End  
(14\*1.5/12\*1.5/223)



**FI1517**  
Link Stabilizer  
L=315



**FI2040**  
Lower Control Arm

**FI2041**  
Lower Control Arm

**PANDA**

**REAR**

**FI1518**  
Link Stabilizer  
L=81



**LEFT**

**RIGHT**

**FIAT**

**PUNTO**

**FRONT**

**ALL MODELS**

*Year*

**2000-2005**

**FI1020**  
Outer Tie Rod End  
(Ø12\*Ø13/M12\*1.5)

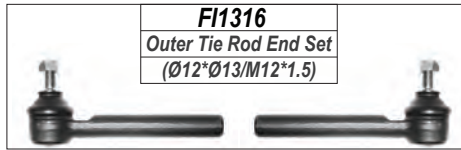

**FI1316**  
Outer Tie Rod End Set  
(Ø12\*Ø13/M12\*1.5)

**FI1422**  
Rack End  
(16\*1.5/12\*1.5/276)



**FI1020**  
Outer Tie Rod End  
(Ø12\*Ø13/M12\*1.5)



**AF1530**  
Link Stabilizer  
L=301



**FI2042**  
Lower Control Arm

**FI2043**  
Lower Control Arm

**FI2810**  
Shock Mounting



**FI2810**  
Shock Mounting



**LEFT**

**RIGHT**

**FIAT**

**PUNTO  
GRANDE PUNTO**

**FRONT**

**ALL MODELS**

*Year*

**2005-**

**AF1026**  
Outer Tie Rod End  
(Ø11.8\*Ø14.8/M14\*1.5)

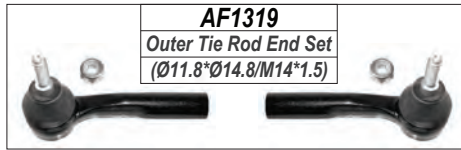

**AF1319**  
Outer Tie Rod End Set  
(Ø11.8\*Ø14.8/M14\*1.5)

**AF1027**  
Outer Tie Rod End  
(Ø11.8\*Ø14.8/M14\*1.5)



**FI1417**  
Rack End  
(14\*1.5/14\*1.5/289)

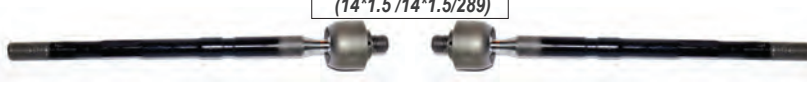

**AF1530**  
Link Stabilizer  
L=301



**AF2122**  
Lower Control Arm Bush



**AF1913**  
Lower Ball Joint  
(Ø20.55)



**AF1913**  
Lower Ball Joint  
(Ø20.55)



**AF2026**  
Lower Control Arm

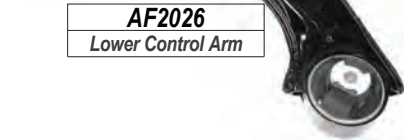

**AF2027**  
Lower Control Arm



**AF2123**  
Lower Control Arm Bush



**FI2811**  
Shock Mounting



**FI2811**  
Shock Mounting



**LEFT**

**RIGHT**

**FIAT**

**SEICENTO**

**FRONT**

**ALLMODELS**

*Year*

**2001-2003**



**LEFT**

**RIGHT**



**FIAT**

**STILO**

**FRONT**

**ALL MODELS**

*Year*

**2003-**

**FI1014**  
Outer Tie Rod End  
(Ø11.72\*Ø14.8/M14\*1.5)

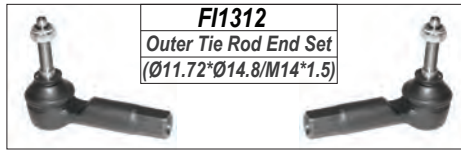

**FI1312**  
Outer Tie Rod End Set  
(Ø11.72\*Ø14.8/M14\*1.5)

**FI1411**  
Rack End  
(14\*1.5/14\*1.5/311)

**FI1014**  
Outer Tie Rod End  
(Ø11.72\*Ø14.8/M14\*1.5)



**AF1517 / AF1518**  
Link Stabilizer  
L=116



**FI2116**  
Lower Control Arm Bush



**FI2046**  
Lower Control Arm

**FI2047**  
Lower Control Arm

**FI2112**  
Lower Control Arm Bush

**FI2116**  
Lower Control Arm Bush

**FI1912**  
Lower Ball Joint  
(Ø17)



**FI1912**  
Lower Ball Joint  
(Ø17)



**FI2018**  
Lower Control Arm

**FI2019**  
Lower Control Arm



**FI2117**  
Lower Control Arm Bush

**LEFT**

**RIGHT**

**FIAT**  
**STRADA**

**FRONT**

**ALL MODELS**

Year

**2005-**

**FI1015**  
Outer Tie Rod End  
(Ø12\*Ø13.6/M14\*1.5)



**FI1315**  
Outer Tie Rod End Set  
(Ø11.7\*Ø14.8/M14\*1.5)

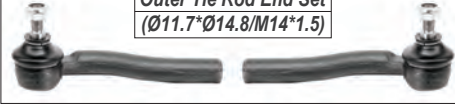

**FI1016**  
Outer Tie Rod End  
(Ø12\*Ø13.6/M14\*1.5)



**FI1418**  
Rack End  
(16\*1.5/14\*1.5/283)



**FI1419**  
Rack End  
(14\*1.5/14\*1.5/281)



**FI1420**  
Rack End  
(16\*1.5/14\*1.5/265)



**FI1913**  
Lower Ball Joint  
(Ø13.6)



**FI2122**  
Lower Control Arm Bush



**FI1913**  
Lower Ball Joint  
(Ø13.6)



**FI2020**  
Lower Control Arm



**FI2021**  
Lower Control Arm



**FI2120 / FI2121**  
Lower Control Arm Bush



**FI1917**  
Lower Ball Joint  
(Ø13.1)



**FI2038**  
Lower Control Arm  
Pow Steering 02-

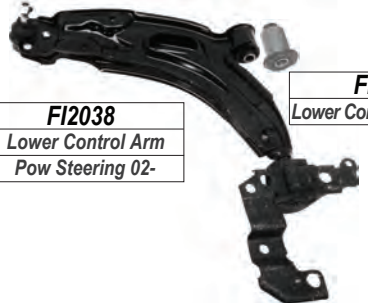

**FI2122**  
Lower Control Arm Bush



**FI2039**  
Lower Control Arm  
Pow Steering 02-

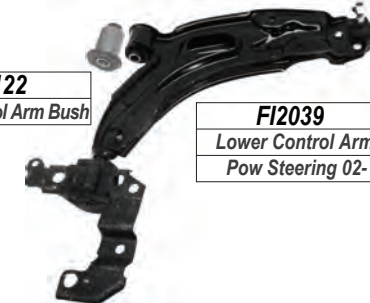

**FI1917**  
Lower Ball Joint  
(Ø13.1)



**FI2129 / FI2130**  
Lower Control Arm Bush



**LEFT**

**RIGHT**

**FIAT**

**ULYSSE**

**FRONT**

**ALL MODELS**

*Year*

**1994-2002**

**FI1022**  
Outer Tie Rod End  
(Ø12.65\*Ø14.5/M14\*1.5)

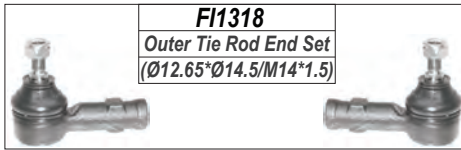

**FI1318**  
Outer Tie Rod End Set  
(Ø12.65\*Ø14.5/M14\*1.5)

**FI1417**  
Rack End  
(14\*1.5/14\*1.5/301)

**FI1022**  
Outer Tie Rod End  
(Ø12.65\*Ø14.5/M14\*1.5)

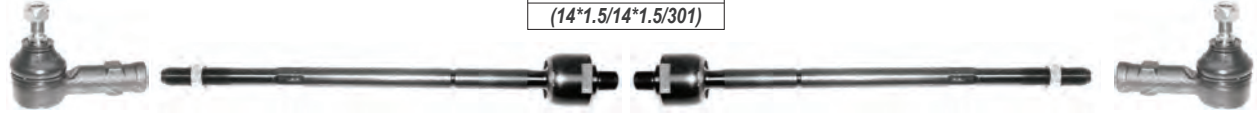

**AF1519**  
Link Stabilizer  
L=122



**AF2132**  
Lower Control Arm Bush



**FI2048**  
Lower Control Arm

**FI2049**  
Lower Control Arm

**AF2133 / AF2134**  
Lower Control Arm Bush

**LEFT**

**RIGHT**

**FIAT**

**ULYSSE**

**FRONT**

**ALL MODELS**

*Year*

**2002-**

**FI1023**  
Outer Tie Rod End  
(Ø13.6\*Ø15.5/M14\*1.5)

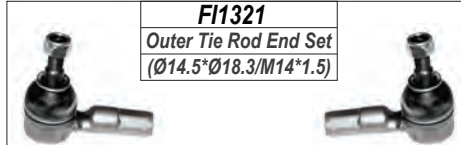
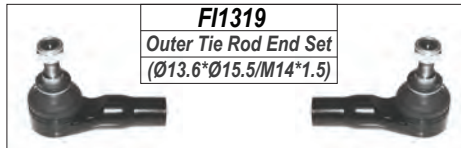

**FI1023**  
Outer Tie Rod End  
(Ø13.6\*Ø15.5/M14\*1.5)



**FI1424**  
Rack End  
(14\*1.5/14\*1.5/313)



**FI1024**  
Outer Tie Rod End  
(Ø14.5\*Ø18.3/M14\*1.5)



**FI1024**  
Outer Tie Rod End  
(Ø14.5\*Ø18.3/M14\*1.5)



**AF1520**  
Link Stabilizer  
L=263



**AF2132**  
Lower Control Arm Bush



**FI2050**  
Lower Control Arm

**FI2051**  
Lower Control Arm

**AF2135 / AF2136**  
Lower Control Arm Bush

**LEFT**

**RIGHT**

**FIAT**

**UNO**

**FRONT**

**ALL MODELS**

*Year*

**1990-2005**

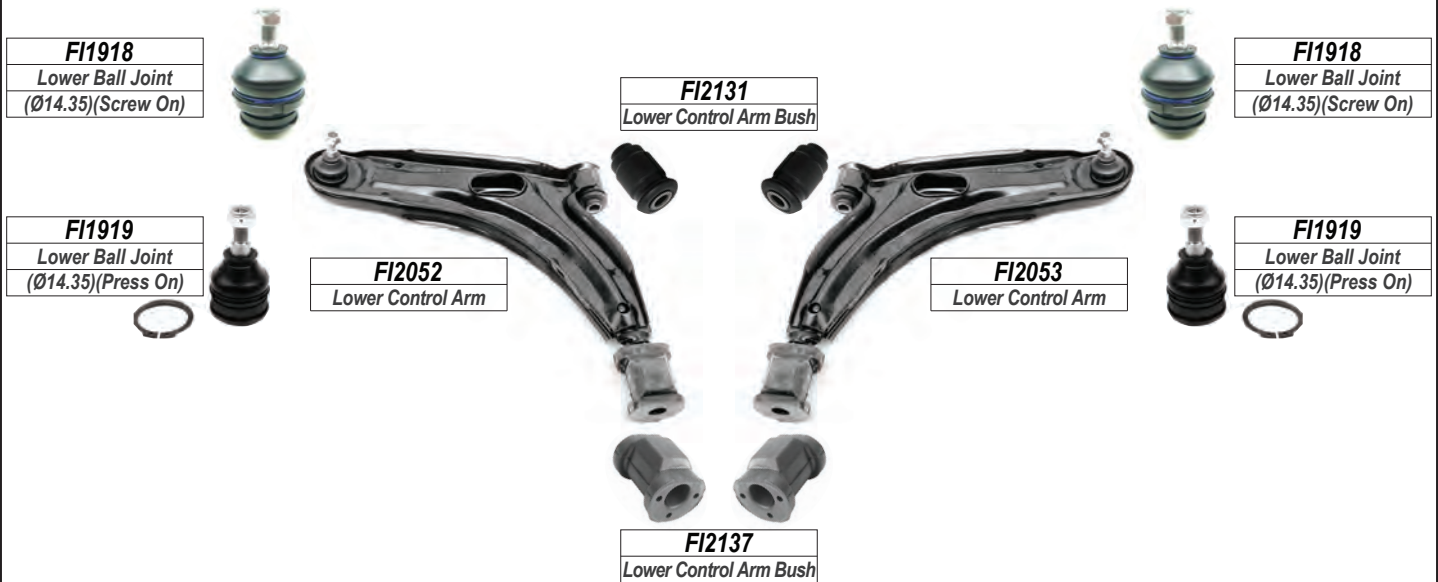
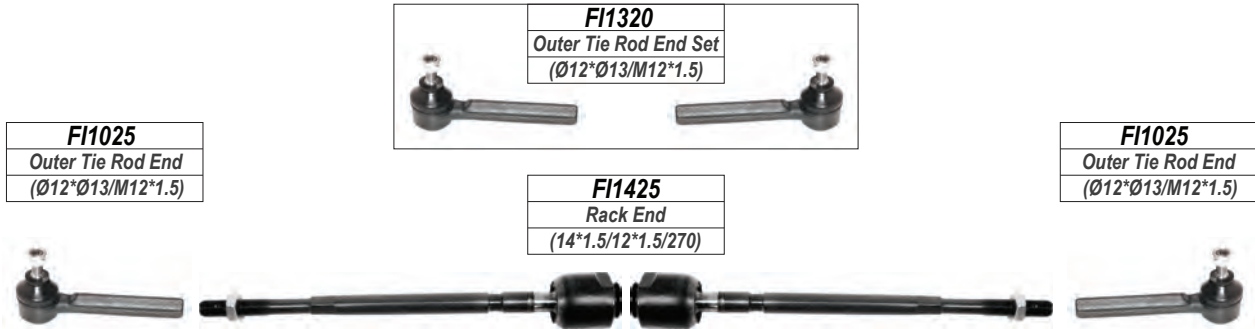

**UNO**

**REAR**



**LEFT**

**RIGHT**



**FORD**

**BANTAM**

**FRONT**

**ALL**

*Year*

**1983-1994**

**FO1025**  
Outer Tie Rod End  
(Ø11.55\*Ø13.3/M12\*20)

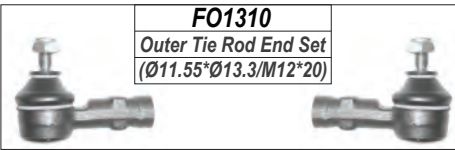

**FO1310**  
Outer Tie Rod End Set  
(Ø11.55\*Ø13.3/M12\*20)

**FO1025**  
Outer Tie Rod End  
(Ø11.55\*Ø13.3/M12\*20)



**FO1421**  
Rack End  
(14\*1.5/12\*20/290)



**FO1510**  
Link Stabilizer  
L=239



**FO2110**  
Lower Control Arm Bush



**FO2111**  
Lower Control Arm Bush



**FO2110**  
Lower Control Arm Bush



**FO2010**  
Lower Control Arm  
1983-1986



**FO2011**  
Lower Control Arm  
1983-1986

**FO2110**  
Lower Control Arm Bush



**FO2111**  
Lower Control Arm Bush



**FO2110**  
Lower Control Arm Bush



**FO2012**  
Lower Control Arm  
1986-1994



**FO2013**  
Lower Control Arm  
1986-1994

**FO2810**  
Stabilizer Bar Bush



**FO2811**  
Stabilizer Bar Bush



**LEFT**

**RIGHT**

**FORD**

**BANTAM**

**FRONT**

**ALL**

*Year*

**1994-2002**

**FO1026**  
Outer Tie Rod End  
(Ø12.9\*Ø14/M12\*1.5)

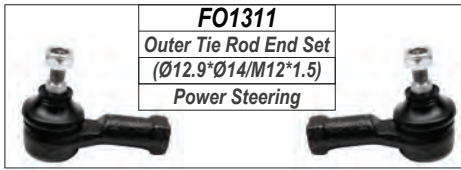

**FO1311**  
Outer Tie Rod End Set  
(Ø12.9\*Ø14/M12\*1.5)  
Power Steering

**FO1026**  
Outer Tie Rod End  
(Ø12.9\*Ø14/M12\*1.5)



**FO1422**  
Rack End(PS)  
(17\*1.0/12\*1.25/306)

**FO1027**  
Outer Tie Rod End  
(Ø11.5\*Ø13.8/M14\*2)



**FO1312**  
Outer Tie Rod End Set  
(Ø11.5\*Ø13.8/M14\*2)  
Alt.

**FO1028**  
Outer Tie Rod End  
(Ø11.5\*Ø13.8/M14\*2)



**FO1029**  
Outer Tie Rod End  
(Ø13.2\*Ø15.1/M12\*1.25)

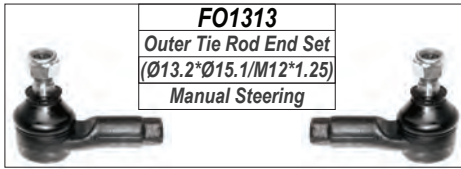

**FO1313**  
Outer Tie Rod End Set  
(Ø13.2\*Ø15.1/M12\*1.25)  
Manual Steering

**FO1029**  
Outer Tie Rod End  
(Ø13.2\*Ø15.1/M12\*1.25)



**FO1410**  
Rack End(MS)  
(14\*1.5/12\*1.5/305)

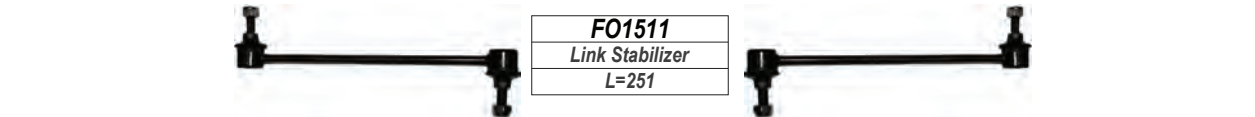

**FO1511**  
Link Stabilizer  
L=251

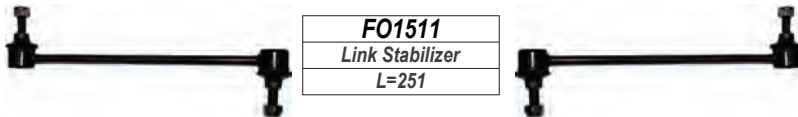

**FO2145**  
Lower Control Arm Bush



**FO1912**  
Lower Ball Joint  
(Ø16)



**FO1912**  
Lower Ball Joint  
(Ø16)

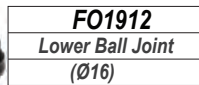

**FO2014**  
Lower Control Arm



**FO2015**  
Lower Control Arm

**FO2812**  
Stabilizer Bar Bush



**FO2812**  
Stabilizer Bar Bush



**FO2817**  
Shock Mounting



**FO2817**  
Shock Mounting



**FO2112**  
Lower Control Arm Bush



**LEFT**

**RIGHT**

**FORD**

**BANTAM**

**FRONT**

**ROCAM**

*Year*

**2003-**

**FO1027**  
Outer Tie Rod End  
(Ø11.5\*Ø13.8/M14\*2)

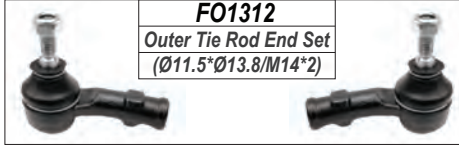

**FO1312**  
Outer Tie Rod End Set  
(Ø11.5\*Ø13.8/M14\*2)

**FO1028**  
Outer Tie Rod End  
(Ø11.5\*Ø13.8/M14\*2)



**FO1423**  
Rack End  
(14\*1.5/14\*2/307)

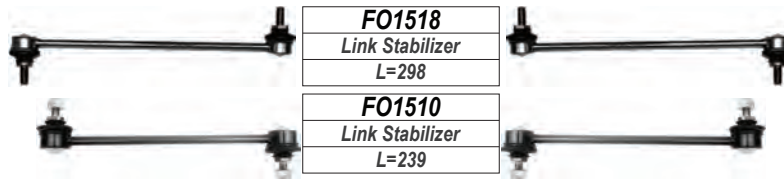

**FO1518**  
Link Stabilizer  
L=298

**FO1510**  
Link Stabilizer  
L=239

**FO2113**  
Lower Control Arm Bush



**FO2016**  
Lower Control Arm

**FO2017**  
Lower Control Arm



**FO2114**  
Lower Control Arm Bush

**FO2113**  
Lower Control Arm Bush



**FO2028**  
Lower Control Arm

**FO2029**  
Lower Control Arm



**FO2114**  
Lower Control Arm Bush

**FO2818**  
Shock Mounting



**FO2818**  
Shock Mounting



**LEFT**

**RIGHT**

**FORD**

**B-MAX**

**FRONT**

**1.0 ECOBOOST**

*Year*

**2015-**

**FO1010**  
Outer Tie Rod End  
(Ø12.9\*Ø15.65/M14\*1.5)

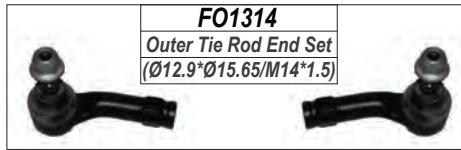

**FO1314**  
Outer Tie Rod End Set  
(Ø12.9\*Ø15.65/M14\*1.5)

**FO1411**  
Rack End  
(14\*1.5/14\*1.5/295)



**FO1011**  
Outer Tie Rod End  
(Ø12.9\*Ø15.65/M14\*1.5)



**FO1512**  
Link Stabilizer  
L=251



**FO1910**  
Lower Ball Joint  
(Ø17.5)



**FO2018**  
Lower Control Arm

**FO2019**  
Lower Control Arm

**FO1910**  
Lower Ball Joint  
(Ø17.5)



**B-MAX**

**REAR**

**FO2820**  
Shock Mounting



**FO2820**  
Shock Mounting



**LEFT**

**RIGHT**



**FORD**

**COURIER**

**FRONT**

**2WD**

*Year*

**1986-2000**

**FO1316**

Outer Tie Rod End Set  
(Ø13.25\*Ø15/M14\*1.5)

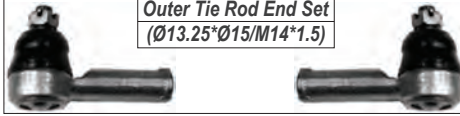

**FO1315(Pin)15mm**

Inner Tie Rod End Set  
(Ø15\*Ø17/M14\*1.5)



**FO1317(Pin)14mm**

Inner Tie Rod End Set  
(Ø14\*Ø15/M14\*1.5)



**FO1030**

Outer Tie Rod End  
(Ø13.25\*Ø15/M14\*1.5)



**FO1111(Pin)15mm**

Inner Tie Rod End  
(Ø15\*Ø17/M14\*1.5)



**FO1030**

Outer Tie Rod End  
(Ø13.25\*Ø15/M14\*1.5)



**FO1112(Pin)14mm**

Inner Tie Rod End  
(Ø14\*Ø15/M14\*1.5)



**FO1611**

Upper Ball Joint  
(Ø13.6)



**FO1810**

Upper Control Arm Bush



**FO1611**

Upper Ball Joint  
(Ø13.6)



**FO1710**

Upper Control Arm



**FO1711**

Upper Control Arm

**FO1914**

Lower Ball Joint  
(Ø18)



**FO2020**

Lower Control Arm



**FO2021**

Lower Control Arm

**FO1914**

Lower Ball Joint  
(Ø18)



**FO2410**

Idler Arm



**CA2110**

Lower Control Arm Bush



**FO2512**

Pitman Arm  
Spline : 27mm / (Ø10)



**FO2513**

Pitman Arm  
25 mm Spline



**LEFT**

**RIGHT**



**FORD**

**COURIER**

**FRONT**

**4WD**

*Year*

**1990-2000**

**FO1318**

Outer Tie Rod End Set  
(Ø13.85\*Ø16.1/M14\*1.5)

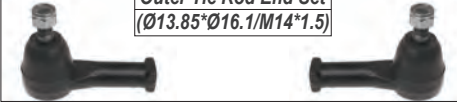

**FO1315(Pin)15mm**

Inner Tie Rod End Set  
(Ø15\*Ø17/M14\*1.5)



**FO1317(Pin)14mm**

Inner Tie Rod End Set  
(Ø14\*Ø15/M14\*1.5)



**FO1031**

Outer Tie Rod End  
(Ø13.85\*Ø16.1/M14\*1.5)



**FO1111(Pin)15mm**

Inner Tie Rod End  
(Ø15\*Ø17/M14\*1.5)



**FO1031**

Outer Tie Rod End  
(Ø13.85\*Ø16.1/M14\*1.5)



**FO1112(Pin)14mm**

Inner Tie Rod End  
(Ø14\*Ø15/M14\*1.5)



**FO1611**

Upper Ball Joint  
(Ø13.6)



**FO1810**  
Upper Control Arm Bush



**FO1611**

Upper Ball Joint  
(Ø13.6)



**FO1712**

Upper Control Arm

**FO1713**

Upper Control Arm

**FO1915**

Lower Ball Joint  
(Ø17.75)



**FO2115**  
Lower Control Arm Bush



**FO1915**

Lower Ball Joint  
(Ø17.75)



**FO2022**

Lower Control Arm

**CA2110**  
Lower Control Arm Bush



**FO2023**

Lower Control Arm

**FO2512**

Pitman Arm  
Splines : 27mm / (Ø10)



**FO2410**

Idler Arm



**LEFT**

**RIGHT**

**FORD**

**ECOSPORT**

**FRONT**

**CBW-CB1**

*Year*

**2013-**

**FO1010**  
Outer Tie Rod End  
(Ø12.9\*Ø15.65/M14\*1.5)

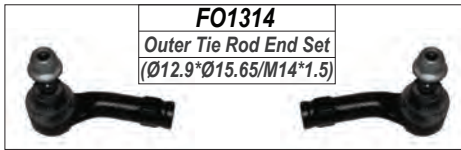

**FO1314**  
Outer Tie Rod End Set  
(Ø12.9\*Ø15.65/M14\*1.5)

**FO1411**  
Rack End  
(14\*1.5/14\*1.5/295)



**FO1011**  
Outer Tie Rod End  
(Ø12.9\*Ø15.65/M14\*1.5)



**FO1512**  
Link Stabilizer  
L=251



**FO2142**  
Lower Control Arm Bush



**FO1910**  
Lower Ball Joint  
(Ø17.5)



**FO2078**  
Lower Control Arm

**FO2079**  
Lower Control Arm

**FO1910**  
Lower Ball Joint  
(Ø17.5)



**FO2143**  
Lower Control Arm Bush



**FO2819**  
Shock Mounting



**FO2819**  
Shock Mounting



**ECOSPORT**

**REAR**

**FO2820**  
Shock Mounting



**FO2820**  
Shock Mounting



**LEFT**

**RIGHT**

**FORD**

**ESCORT**

**FRONT**

**MKI / MKII**

*Year*

**1968-1981**

**FO1025(MK1)**  
Outer Tie Rod End  
(Ø11.55\*Ø13.3/M12\*20)

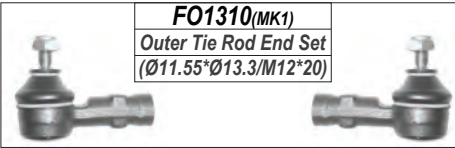

**FO1310(MK1)**  
Outer Tie Rod End Set  
(Ø11.55\*Ø13.3/M12\*20)

**FO1421(MK1)**  
Rack End  
(14\*1.5/12\*20/290)

**FO1025(MK1)**  
Outer Tie Rod End  
(Ø11.55\*Ø13.3/M12\*20)



**FO1032(MK2)**  
Outer Tie Rod End  
(Ø12.77\*Ø14.7/M14\*2)



**FO1319(MK2)**  
Outer Tie Rod End Set  
(Ø12.77\*Ø14.7/M14\*2)

**FO1424(MK2)**  
Rack End  
(14\*1.5/14\*2.0/262)

**FO1032(MK2)**  
Outer Tie Rod End  
(Ø12.77\*Ø14.7/M14\*2)



**FO2116**  
Lower Control Arm Bush

**FO2024**  
Lower Control Arm



**FO2116**  
Lower Control Arm Bush

**FO2025**  
Lower Control Arm

**FO2810**  
Stabilizer Bar Bush



**LEFT**

**RIGHT**

**FORD**

**ESCORT**

**FRONT**

**MKIII /MKIV**

*Year*

**1981-1990**

**F01025**  
Outer Tie Rod End  
(Ø11.55\*Ø13.3/M12\*20)

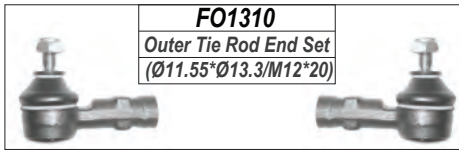

**F01310**  
Outer Tie Rod End Set  
(Ø11.55\*Ø13.3/M12\*20)

**F01025**  
Outer Tie Rod End  
(Ø11.55\*Ø13.3/M12\*20)



**F01421**  
Rack End  
(14\*1.5/12\*20/290)



**F01510**  
Link Stabilizer  
L=239



**F02010**  
Lower Control Arm  
Mk3



**F02011**  
Lower Control Arm  
Mk3

**F02110**  
Lower Control Arm Bush

**F02111**  
Lower Control Arm Bush

**F02110**  
Lower Control Arm Bush



**F02012**  
Lower Control Arm  
Mk4

**F02013**  
Lower Control Arm  
Mk4

**F02810**  
Stabilizer Bar Bush



**F02811**  
Stabilizer Bar Bush



**LEFT**

**RIGHT**

**FORD**

**ESCORT**

**FRONT**

**Z TECH**

*Year*

**1990-2000**

**FO1012**  
Outer Tie Rod End  
(Ø13.27\*Ø16.1/M14\*20)

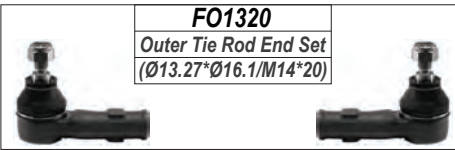

**FO1320**  
Outer Tie Rod End Set  
(Ø13.27\*Ø16.1/M14\*20)

**FO1013**  
Outer Tie Rod End  
(Ø13.27\*Ø16.1/M14\*20)

**FO1425**  
Rack End  
(14\*1.5/14\*2.0/305)

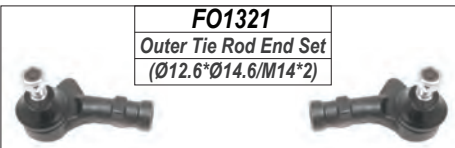

**FO1321**  
Outer Tie Rod End Set  
(Ø12.6\*Ø14.6/M14\*2)

**FO1033**  
Outer Tie Rod End  
(Ø12.6\*Ø14.6/M14\*2)



**FO1426**  
Rack End  
(14\*1.5/14\*2.0/318)

**FO1034**  
Outer Tie Rod End  
(Ø12.6\*Ø14.6/M14\*2)



**FO1510**  
Link Stabilizer  
L=239



**FO2117**  
Lower Control Arm Bush



**FO1916**  
Lower Ball Joint  
(Ø17)



**FO1916**  
Lower Ball Joint  
(Ø17)

**FO2026**  
Lower Control Arm



**FO2027**  
Lower Control Arm



**FO2118**  
Lower Control Arm Bush



**FO2810**  
Stabilizer Bar Bush



**FO2821**  
Shock Mounting



**FO2821**  
Shock Mounting



**LEFT**

**RIGHT**



**FORD**

**EVEREST**

**FRONT**

**3.0 TDCI**

*Year*

**2009-2015**

**FO1322**

Outer Tie Rod End Set  
(Ø15\*Ø17/M14\*1.5)



**FO1323**

Inner Tie Rod End Set  
(Ø14.9\*Ø17/M14\*1.5)



**FO1014**

Outer Tie Rod End  
(Ø15\*Ø17/M14\*1.5)



**FO1110**

Inner Tie Rod End  
(Ø14.9\*Ø17/M14\*1.5)



**FO1014**

Outer Tie Rod End  
(Ø15\*Ø17/M14\*1.5)



**FO1611**

Upper Ball Joint  
(Ø13.6)



12mm

**FO2710**

Repair Kit



12mm

**FO1611**

Upper Ball Joint  
(Ø13.6)



**FO1712**

Upper Control Arm

**FO1713**

Upper Control Arm



14mm

**FO2711**

Repair Kit



14mm

**FO1722**

Upper Control Arm

**FO1723**

Upper Control Arm

**FO2115**

Lower Control Arm Bush

**FO1917**

Lower Ball Joint  
(Ø19.4)



**FO1917**

Lower Ball Joint  
(Ø19.4)



**FO2022**

Lower Control Arm

**FO2023**

Lower Control Arm

**CA2110**

Lower Control Arm Bush

**FO2411**

Idler Arm  
10 mm Hole



**FO2412**

Idler Arm  
14 mm Hole



**FO2413**

Idler Arm  
14 mm Hole / Opp Bracket



**FO2510**

Pitman Arm



**LEFT**

**RIGHT**

**FORD**

**FIESTA**

**FRONT**

**IV**

*Year*

**1997-2004**

**FO1027**  
Outer Tie Rod End  
(Ø11.5\*Ø13.8/M14\*2)

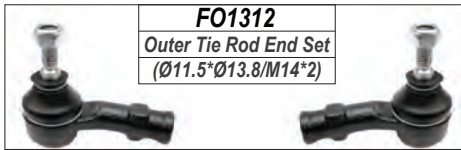

**FO1312**  
Outer Tie Rod End Set  
(Ø11.5\*Ø13.8/M14\*2)

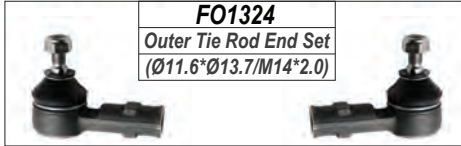

**FO1324**  
Outer Tie Rod End Set  
(Ø11.6\*Ø13.7/M14\*2.0)

**FO1028**  
Outer Tie Rod End  
(Ø11.5\*Ø13.8/M14\*2)



**FO1015**  
Outer Tie Rod End  
(Ø11.6\*Ø13.7/M14\*2.0)

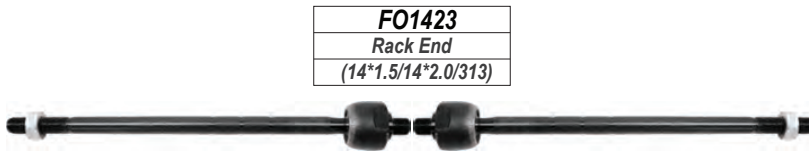

**FO1423**  
Rack End  
(14\*1.5/14\*2.0/313)

**FO1015**  
Outer Tie Rod End  
(Ø11.6\*Ø13.7/M14\*2.0)

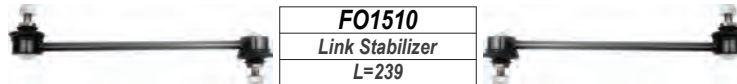

**FO1510**  
Link Stabilizer  
L=239

**FO2113**  
Lower Control Arm Bush



**FO2016**  
Lower Control Arm

**FO2017**  
Lower Control Arm



**FO2114**  
Lower Control Arm Bush

**FO2113**  
Lower Control Arm Bush

**FO1913**  
Lower Ball Joint  
(Ø16.5)



**FO1913**  
Lower Ball Joint  
(Ø16.5)

**FO2818**  
Shock Mounting



**FO2028**  
Lower Control Arm



**FO2029**  
Lower Control Arm

**FO2818**  
Shock Mounting



**FO2114**  
Lower Control Arm Bush

**LEFT**

**RIGHT**

**FORD**

**FIESTA**

**FRONT**

**V**

Year

2004-2008

**FO1035**  
Outer Tie Rod End  
(Ø11.55\*Ø13.8/M14\*1.5)

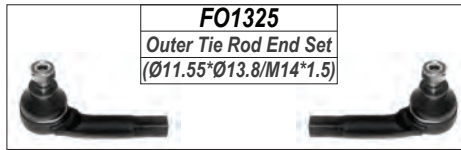

**FO1325**  
Outer Tie Rod End Set  
(Ø11.55\*Ø13.8/M14\*1.5)

**FO1435**  
Rack End  
(14\*1.5/14\*1.5/277)



**FO1036**  
Outer Tie Rod End  
(Ø11.55\*Ø13.8/M14\*1.5)



**FO1514**  
Link Stabilizer  
L=283



**FO2120**  
Lower Control Arm Bush

**FO1918**  
Lower Ball Joint  
(Ø17.5)



**FO2032**  
Lower Control Arm



**FO2033**  
Lower Control Arm



**FO1918**  
Lower Ball Joint  
(Ø17.5)



**FO2119**  
Lower Control Arm Bush



**FO2822**  
Shock Mounting



**FO2822**  
Shock Mounting



**FIESTA**

**REAR**

**FO2824**  
Shock Mounting



**FO2824**  
Shock Mounting



**LEFT**

**RIGHT**

**FORD**

**FIESTA**

**FRONT**

Year

**2008-**

**VI**

**FO1010**  
Outer Tie Rod End  
(Ø12.9\*Ø15.65/M14\*1.5)

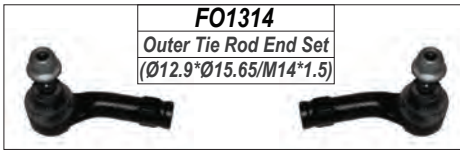

**FO1314**  
Outer Tie Rod End Set  
(Ø12.9\*Ø15.65/M14\*1.5)

**FO1411**  
Rack End  
(14\*1.5/14\*1.5/295)



**FO1011**  
Outer Tie Rod End  
(Ø12.9\*Ø15.65/M14\*1.5)



**FO1326**  
Outer Tie Rod End Set  
(Ø15.6\*Ø12.34/M14\*1.5)

**FO1037**  
Outer Tie Rod End  
(Ø15.6\*Ø12.34/M14\*1.5)



**FO1427**  
Rack End  
(14\*1.5/14\*1.5/213)



**FO1038**  
Outer Tie Rod End  
(Ø15.6\*Ø12.34/M14\*1.5)



**FO1512**  
Link Stabilizer  
L=251



**FO1514**  
Link Stabilizer  
L=282



**FO2121**  
Lower Control Arm Bush

**FO1910**  
Lower Ball Joint  
(Ø17.5)



**FO2034**  
Lower Control Arm

**FO2035**  
Lower Control Arm

**FO1910**  
Lower Ball Joint  
(Ø17.5)



**FO2819**  
Shock Mounting



**FO2819**  
Shock Mounting



**FO2823**  
Shock Mounting



**FO2122**  
Lower Control Arm Bush



**FO2823**  
Shock Mounting



**FIESTA**

**REAR**

**FO2820**  
Shock Mounting



**FO2820**  
Shock Mounting



**LEFT**

**RIGHT**



**FORD**

Year

FIGO

FRONT

1.4 1.4 TDCI

2010-2016

**FO1035**  
Outer Tie Rod End  
(Ø11.55\*Ø13.8/M14\*1.5)



**FO1325**  
Outer Tie Rod End Set  
(Ø11.55\*Ø13.8/M14\*1.5)



**FO1435**  
Rack End  
(14\*1.5/14\*1.5/277)



**FO1036**  
Outer Tie Rod End  
(Ø11.55\*Ø13.8/M14\*1.5)



**FO1514**  
Link Stabilizer  
L=283



**FO2120**  
Lower Control Arm Bush



**FO1919**  
Lower Ball Joint  
(Ø18)



**FO1919**  
Lower Ball Joint  
(Ø18)



**FO2036**  
Lower Control Arm



**FO2037**  
Lower Control Arm



**FO2123**  
Lower Control Arm Bush

**FO2822**  
Shock Mounting



**FO2822**  
Shock Mounting



FIGO

REAR

**FO2824**  
Shock Mounting



**FO2824**  
Shock Mounting



LEFT

RIGHT



**FORD**

**FIGO**

**FRONT**

**ALL**

**Year**

**2016-**

**FO1010**  
Outer Tie Rod End  
(Ø12.9\*Ø15.65/M14\*1.5)

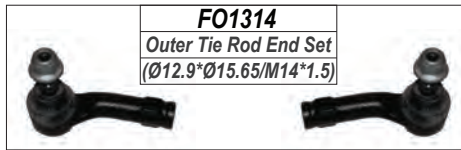

**FO1314**  
Outer Tie Rod End Set  
(Ø12.9\*Ø15.65/M14\*1.5)

**FO1413**  
Rack End  
(14\*1.5/14\*1.5/311)



**Outer Tie Rod End**  
(Ø12.9\*Ø15.65/M14\*1.5)



**FO1515**  
Link Stabilizer  
L=250.5



**FO2121**  
Lower Control Arm Bush

**FO2121**  
Lower Control Arm Bush



**FO2122**  
Lower Control Arm Bush

**FO2122**  
Lower Control Arm Bush



**FO2034**  
Lower Control Arm

**FO2034**  
Lower Control Arm

**FO2035**  
Lower Control Arm

**FO2035**  
Lower Control Arm

**FO1910**  
Lower Ball Joint  
(Ø17.5)

**FO1910**  
Lower Ball Joint  
(Ø17.5)



**FO2819**  
Shock Mounting



**FO2819**  
Shock Mounting



**FIGO**

**REAR**

**FO2820**  
Shock Mounting



**FO2820**  
Shock Mounting



**LEFT**

**RIGHT**

**FORD**

**FOCUS**

**FRONT**

Year

2000-2005

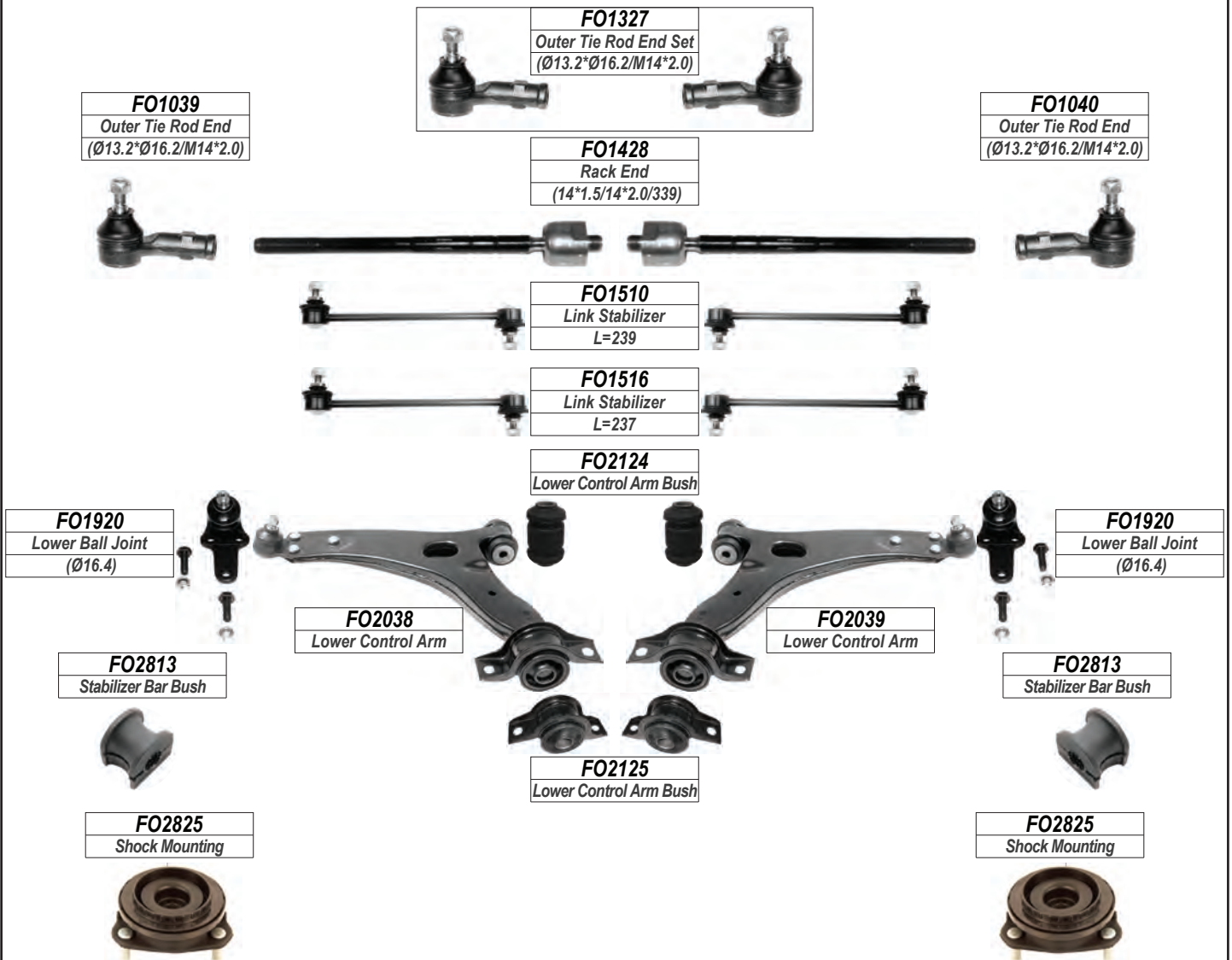

**FOCUS**

**REAR**

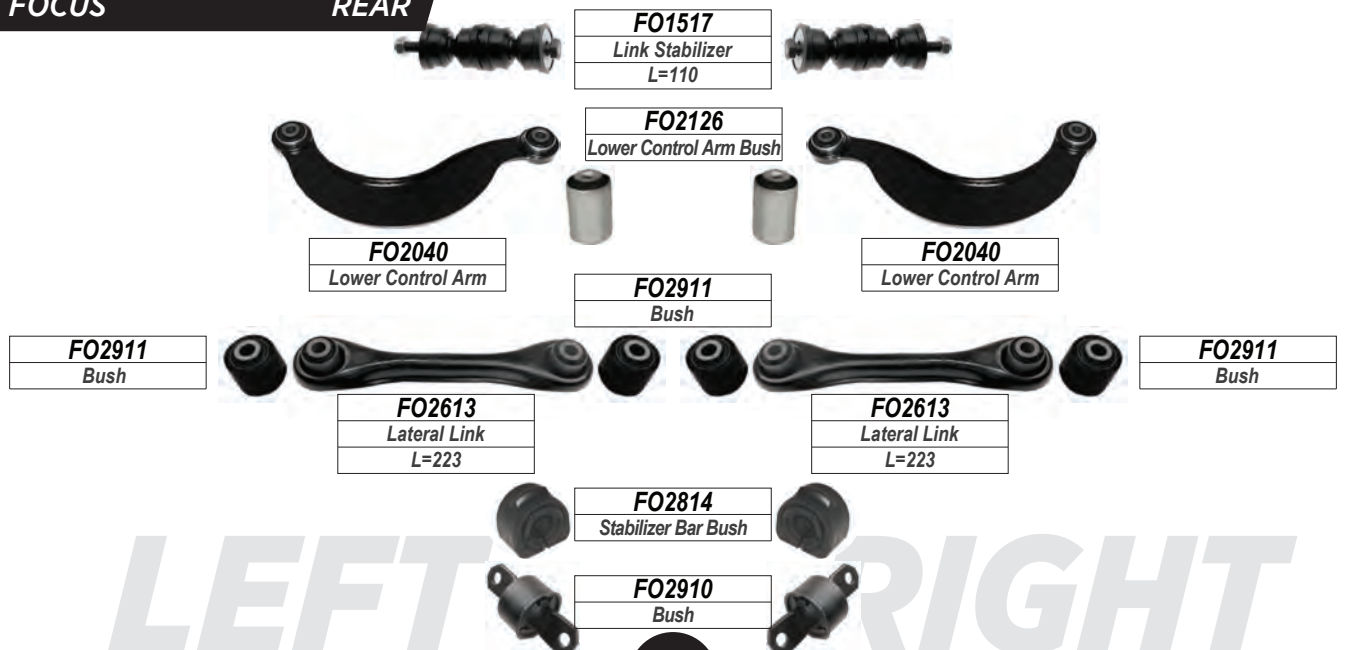

LEFT RIGHT

**FORD**

**FOCUS**

**FRONT**

**II**

*Year*

**2005-2009**

**FO1041**  
Outer Tie Rod End  
(Ø12.3\*Ø16/M16\*1.5)

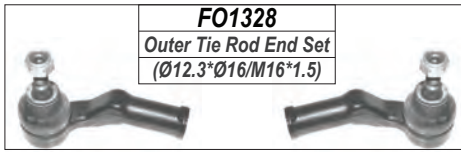

**FO1328**  
Outer Tie Rod End Set  
(Ø12.3\*Ø16/M16\*1.5)

**FO1429**  
Rack End  
(14\*1.5/16\*1.5/291)



**FO1042**  
Outer Tie Rod End  
(Ø12.3\*Ø16/M16\*1.5)



**FO1430**  
Rack End  
(14\*1.5/16\*1.5/293)



**FO1518**  
Link Stabilizer  
L=298



**MA2110**  
Lower Control Arm Bush

**FO1921**  
Lower Ball Joint  
(Ø19)



**FO2041**  
Lower Control Arm

**FO2042**  
Lower Control Arm

**FO1921**  
Lower Ball Joint  
(Ø19)



**FO2127**  
Lower Control Arm Bush



**MA2110**  
Lower Control Arm Bush

**FO1922**  
Lower Ball Joint  
(Ø21)



**FO2043**  
Lower Control Arm

**FO2044**  
Lower Control Arm

**FO1922**  
Lower Ball Joint  
(Ø21)



**FO2826**  
Shock Mounting



**FO2826**  
Shock Mounting



**FO2127**  
Lower Control Arm Bush



**LEFT**

**RIGHT**

**FORD**

**FOCUS**

**REAR**

**II**

*Year*

**2005-2009**

**FO1519**  
Link Stabilizer  
L=110



**FO1520**  
Link Stabilizer  
L=76



**FO1521**  
Link Stabilizer  
L=109



**FO2126**  
Lower Control Arm Bush



**FO2040**  
Lower Control Arm

**FO2040**  
Lower Control Arm



**FO2045**  
Lower Control Arm



**FO2045**  
Lower Control Arm

**FO2911**  
Bush



**FO2911**  
Bush

**FO2911**  
Bush

**FO2613**  
Lateral Link  
L=223

**FO2613**  
Lateral Link  
L=223

**FO2910**  
Bush



**LEFT**

**RIGHT**



**FORD**

**FOCUS**

**FRONT**

**III**

Year

**2010-**

**FO1043**  
Outer Tie Rod End  
(Ø12.35\*Ø16.1/M16\*1.5)

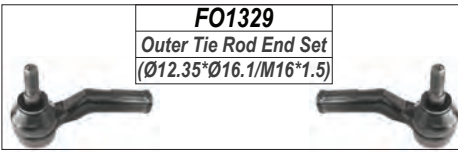

**FO1329**  
Outer Tie Rod End Set  
(Ø12.35\*Ø16.1/M16\*1.5)

**FO1431**  
Rack End  
(14\*1.5/16\*1.5/290)



**FO1044**  
Outer Tie Rod End  
(Ø12.35\*Ø16.1/M16\*1.5)



**FO1041**  
Outer Tie Rod End  
(Ø12.3\*Ø16/M16\*1.5)

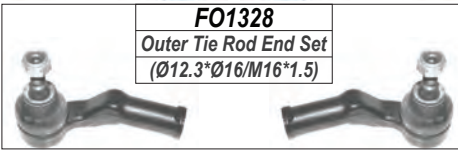

**FO1328**  
Outer Tie Rod End Set  
(Ø12.3\*Ø16/M16\*1.5)

**FO1432**  
Rack End  
(14\*1.5/16\*1.5/295)



**FO1042**  
Outer Tie Rod End  
(Ø12.3\*Ø16/M16\*1.5)

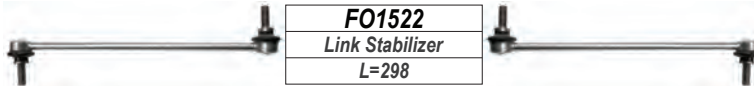

**FO1522**  
Link Stabilizer  
L=298

**FO2129**  
Lower Control Arm Bush



**FO2046**  
Lower Control Arm  
Aluminium

**FO2047**  
Lower Control Arm  
Aluminium



**FO1923**  
Lower Ball Joint  
(Ø21)



**FO1924**  
Lower Ball Joint  
(Ø21)



**FO2128**  
Lower Control Arm Bush

**FO2129**  
Lower Control Arm Bush



**FO2048**  
Lower Control Arm  
Metal

**FO2049**  
Lower Control Arm  
Metal



**FO2826**  
Shock Mounting



**FO2826**  
Shock Mounting



**FO2128**  
Lower Control Arm Bush

**LEFT**

**RIGHT**



**FORD**

**FOCUS**

**REAR**

**III**

*Year*

**2010-**

**FO1521**  
Link Stabilizer  
L=109



**FO1525**  
Link Stabilizer  
L=76 (2014-)



**FO1523**  
Link Stabilizer  
L=50 (1.6)



**FO1524**  
Link Stabilizer  
L=50 (2.0)

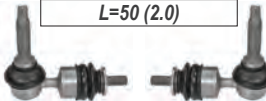

**LEFT**

**RIGHT**

**FORD**

**FUSION**

**REAR**

**1.5.2.0 2.0TDCI**

*Year*

**2015-**

**FO1051**  
Outer Tie Rod End  
(Ø16\*/M18\*1.5)

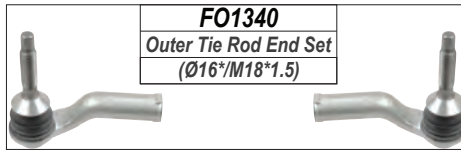

**FO1340**  
Outer Tie Rod End Set  
(Ø16\*/M18\*1.5)

**FO1436**  
Rack End  
(16\*1.5 / 18\*1.5/304)



**FO1052**  
Outer Tie Rod End  
(Ø16\*/M18\*1.5)



**FO1542**  
Link Stabilizer  
L=300



**FO2080**  
Lower Control Arm



**FO2081**  
Lower Control Arm



**FUSION**

**REAR**

**FO1524**  
Link Stabilizer  
L=76.4

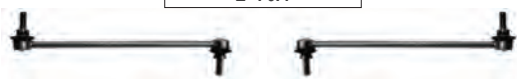

**LEFT**

**RIGHT**

**FORD**

**IKON**

**FRONT**

**ALL MODELS**

**Year**

**2001-**

**FO1015**  
Outer Tie Rod End  
(Ø11.6\*Ø13.7/M14\*1.5)

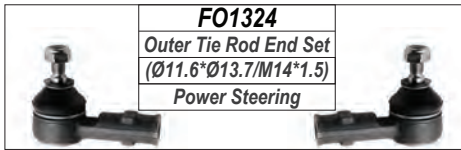

**FO1324**  
Outer Tie Rod End Set  
(Ø11.6\*Ø13.7/M14\*1.5)  
Power Steering

**FO1015**  
Outer Tie Rod End  
(Ø11.6\*Ø13.7/M14\*1.5)



**FO1435**  
Rack End(PS)  
(14\*1.5/14\*1.5/277)

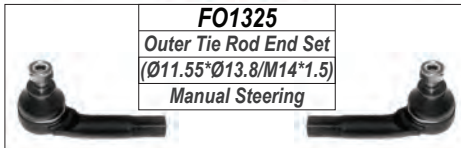

**FO1325**  
Outer Tie Rod End Set  
(Ø11.55\*Ø13.8/M14\*1.5)  
Manual Steering

**FO1035**  
Outer Tie Rod End  
(Ø11.55\*Ø13.8/M14\*1.5)



**FO1423**  
Rack End(MS)  
(14\*1.5/14\*2.0/313)



**FO1036**  
Outer Tie Rod End  
(Ø11.55\*Ø13.8/M14\*1.5)



**FO1510**  
Link Stabilizer  
L=239

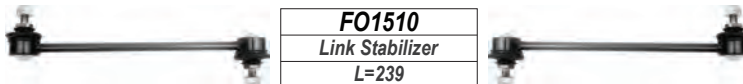

**FO2113**  
Lower Control Arm Bush

**FO1913**  
Lower Ball Joint  
(Ø16.5)



**FO2028**  
Lower Control Arm

**FO2029**  
Lower Control Arm

**FO1913**  
Lower Ball Joint  
(Ø16.5)



**FO2114**  
Lower Control Arm Bush



**FO2113**  
Lower Control Arm Bush



**FO2818**  
Shock Mounting



**FO2016**  
Lower Control Arm



**FO2017**  
Lower Control Arm



**FO2818**  
Shock Mounting



**FO2114**  
Lower Control Arm Bush



**LEFT**

**RIGHT**

**FORD**

KA

FRONT

ALL MODELS

Year

2005-2009

**FO1025**  
Outer Tie Rod End  
(Ø11.55\*Ø13.3/M12\*20)

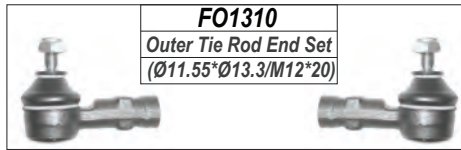

**FO1310**  
Outer Tie Rod End Set  
(Ø11.55\*Ø13.3/M12\*20)

**FO1025**  
Outer Tie Rod End  
(Ø11.55\*Ø13.3/M12\*20)



**FO1015**  
Outer Tie Rod End  
(Ø11.6\*Ø13.7/M14\*1.5)

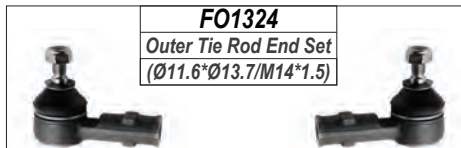

**FO1324**  
Outer Tie Rod End Set  
(Ø11.6\*Ø13.7/M14\*1.5)

**FO1015**  
Outer Tie Rod End  
(Ø11.6\*Ø13.7/M14\*1.5)



**FO1423**  
Rack End  
(14\*1.5/14\*2.0/313)



**FO1510**  
Link Stabilizer  
L=239



**FO1913**  
Lower Ball Joint  
(Ø16.5)



**FO2117**  
Lower Control Arm Bush



**FO1913**  
Lower Ball Joint  
(Ø16.5)



**FO2050**  
Lower Control Arm



**FO2051**  
Lower Control Arm

**FO2118**  
Lower Control Arm Bush



**FO2818**  
Shock Mounting



**FO2818**  
Shock Mounting



LEFT

RIGHT

**FORD**

**KUGA**

**FRONT**

**ALL MODELS**

Year

**2008-**

**FO1045**  
Outer Tie Rod End  
(Ø12.35\*Ø16.1/M16\*1.5)

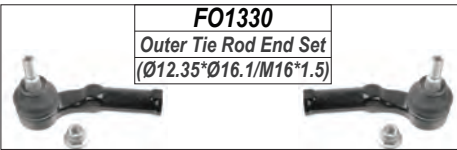

**FO1430**  
Rack End  
(14\*1.5/16\*1.5/293)

**FO1046**  
Outer Tie Rod End  
(Ø12.35\*Ø16.1/M16\*1.5)



**FO1522**  
Link Stabilizer  
L=298



**FO1925**  
Lower Ball Joint  
(Ø21)



**FO2052**  
Lower Control Arm

**FO2053**  
Lower Control Arm

**FO1926**  
Lower Ball Joint  
(Ø21)



**FO2054**  
Lower Control Arm  
2012-



**FO2055**  
Lower Control Arm  
2012-

**FO2826**  
Shock Mounting



**FO2128**  
Lower Control Arm Bush



**FO2826**  
Shock Mounting



**KUGA**

**REAR**

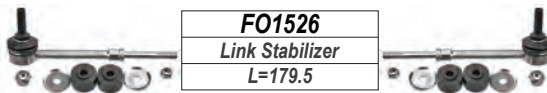

**FO1526**  
Link Stabilizer  
L=179.5



**FO2610**  
Lateral Link



**FO2610**  
Lateral Link

**FO2910**  
Bush



**FO2611**  
Lateral Link



**FO2611**  
Lateral Link

**FO2910**  
Bush



**LEFT**

**RIGHT**



**FORD**

LASER.TRACER

FRONT

ALL MODELS

Year

1986-2002

**FO1029**  
Outer Tie Rod End  
(Ø13.2\*Ø15.1/M12\*1.25)

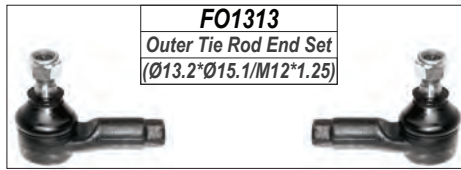

**FO1313**  
Outer Tie Rod End Set  
(Ø13.2\*Ø15.1/M12\*1.25)

**FO1422**  
Rack End  
(17\*1.0/12\*1.25/306)

**FO1029**  
Outer Tie Rod End  
(Ø13.2\*Ø15.1/M12\*1.25)



**FO1026**  
Outer Tie Rod End  
(Ø12.9\*Ø14/M12\*1.5)

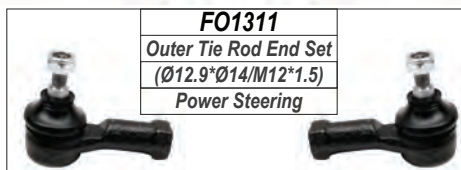

**FO1311**  
Outer Tie Rod End Set  
(Ø12.9\*Ø14/M12\*1.5)  
Power Steering

**FO1410**  
Rack End  
(14\*1.5/12\*1.5/305)

**FO1026**  
Outer Tie Rod End  
(Ø12.9\*Ø14/M12\*1.5)



**FO2145**  
Lower Control Arm Bush



**FO1912**  
Lower Ball Joint  
(Ø16)



**FO1912**  
Lower Ball Joint  
(Ø16)

**FO2014**  
Lower Control Arm



**FO2015**  
Lower Control Arm

**FO2817**  
Shock Mounting



**FO2817**  
Shock Mounting



**FO2112**  
Lower Control Arm Bush



**FO2827**  
Shock Mounting



**FO2827**  
Shock Mounting



LEFT

RIGHT

**FORD**

**MONDEO**

**FRONT**

**II**

Year

1996-2001

**FO1016**  
Outer Tie Rod End  
(Ø12.2\*Ø14.7/M16\*1.5)

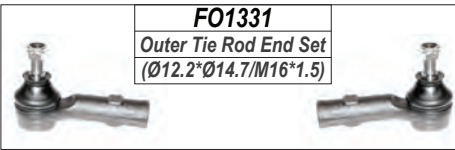

**FO1331**  
Outer Tie Rod End Set  
(Ø12.2\*Ø14.7/M16\*1.5)

**FO1433**  
Rack End  
(14\*1.5/16\*1.5/336)



**FO1017**  
Outer Tie Rod End  
(Ø12.2\*Ø14.7/M16\*1.5)



**FO1434**  
Rack End  
(14\*1.5/16\*1.5/340)



**FO1527**  
Link Stabilizer  
L=237.5

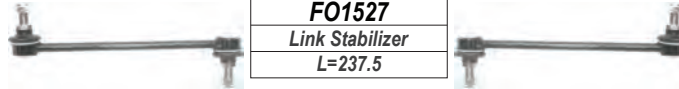

**FO2130**  
Lower Control Arm Bush

**FO1927**  
Lower Ball Joint  
(Ø18)



**FO2056**  
Lower Control Arm

**FO2057**  
Lower Control Arm

**FO1927**  
Lower Ball Joint  
(Ø18)



**FO2132**  
Lower Control Arm Bush



**FO2058**  
Lower Control Arm

**FO2059**  
Lower Control Arm

**FO2131**  
Lower Control Arm Bush

**FO2828**  
Shock Mounting



**FO2828**  
Shock Mounting



**FO2132**  
Lower Control Arm Bush

**MONDEO**

**REAR**



**FO1528**  
Link Stabilizer  
L=118.5



**FO1529**  
Link Stabilizer  
L=160



**FO2612**  
Lateral Link  
L=602

**FO2612**  
Lateral Link  
L=602

**FO2815**  
Stabilizer Bar Bush



**FO2912**  
Bush



**FO2815**  
Stabilizer Bar Bush

**LEFT**

**RIGHT**

**FORD**

**MONDEO**

**FRONT**

**III**

Year

2001-2007

**FO1018**  
Outer Tie Rod End  
(Ø12.6\*Ø16.1/M16\*1.5)

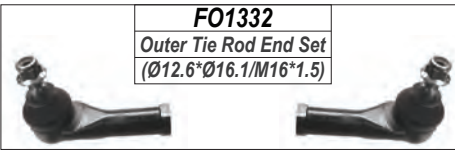

**FO1332**  
Outer Tie Rod End Set  
(Ø12.6\*Ø16.1/M16\*1.5)

**FO1018**  
Outer Tie Rod End  
(Ø12.6\*Ø16.1/M16\*1.5)



**FO1414**  
Rack End  
(14\*1.5/16\*1.5/344)

**FO2816**  
Stabilizer Bar Bush

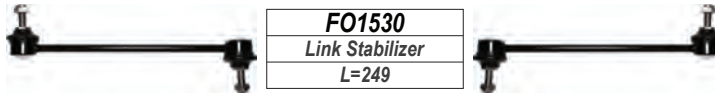

**FO1530**  
Link Stabilizer  
L=249

**FO2816**  
Stabilizer Bar Bush

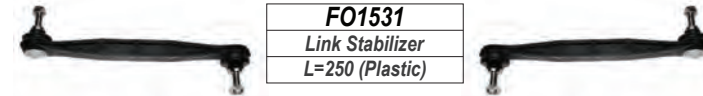

**FO1531**  
Link Stabilizer  
L=250 (Plastic)

**FO2133**  
Lower Control Arm Bush

**FO1928**  
Lower Ball Joint  
(Ø21)



**FO1928**  
Lower Ball Joint  
(Ø21)

**FO2060**  
Lower Control Arm

**FO2061**  
Lower Control Arm

**FO2829**  
Shock Mounting



**FO2829**  
Shock Mounting



**FO2134**  
Lower Control Arm Bush

**MONDEO**

**REAR**



**FO1532**  
Link Stabilizer  
L=254

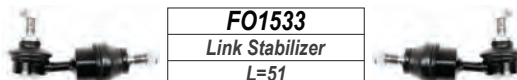

**FO1533**  
Link Stabilizer  
L=51



**FO2614**  
Lateral Link  
L=600

**FO2614**  
Lateral Link  
L=600



**FO2615**  
Lateral Link  
L=571

**FO2615**  
Lateral Link  
L=571



**FO2616**  
Lateral Link  
L=548.5

**FO2616**  
Lateral Link  
L=548.5



**FO2913**  
Bush



**LEFT**

**RIGHT**

**FORD**

**RANGER**

**FRONT**

**ALL MODELS**

*Year*

**2000-2008**

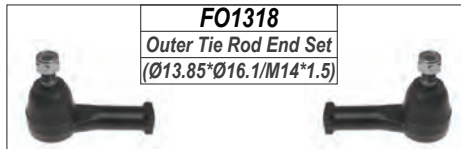
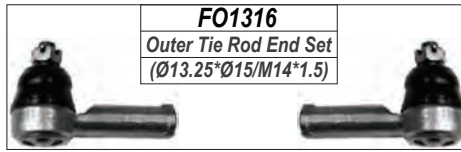

**FO1030**  
Outer Tie Rod End  
(Ø13.25\*Ø15/M14\*1.5)



**FO1112**  
Inner Tie Rod End  
(Ø14\*Ø15/M14\*1.5)



**FO1030**  
Outer Tie Rod End  
(Ø13.25\*Ø15/M14\*1.5)



**FO1031**  
Outer Tie Rod End  
(Ø13.85\*Ø16.1/M14\*1.5)



**FO1111**  
Inner Tie Rod End  
(Ø15\*Ø17/M14\*1.5)



**FO1031**  
Outer Tie Rod End  
(Ø13.85\*Ø16.1/M14\*1.5)



**FO2710**  
Repair Kit



**FO1810**  
Upper Control Arm Bush



**FO1811**  
Upper Control Arm Bush



**FO2710**  
Repair Kit

**FO2711**  
Repair Kit



**FO2711**  
Repair Kit

**LEFT**

**RIGHT**



**FORD**

**RANGER**

**FRONT**

**ALL MODELS**

*Year*

**2000-2008**



**FO2411**  
Idler Arm



**FO2511**  
Idler Arm  
(Ø14.3)



**FO2514**  
Idler Arm  
(Ø15.3)



**LEFT**

**RIGHT**



**FORD**

**RANGER**

**FRONT**

**ALL MODELS**

*Year*

**2008-2011**

**FO1322**

Outer Tie Rod End Set  
(Ø15\*Ø17/M14\*1.5)



**FO1323**

Inner Tie Rod End Set  
(Ø14.9\*Ø17/M14\*1.5)



**FO1014**

Outer Tie Rod End  
(Ø15\*Ø17/M14\*1.5)



**FO1110**

Inner Tie Rod End  
(Ø14.9\*Ø17/M14\*1.5)



**FO1014**

Outer Tie Rod End  
(Ø15\*Ø17/M14\*1.5)



**FO2710**

Repair Kit



**FO1810**

Upper Control Arm Bush



**FO2710**

Repair Kit



**FO1611**

Upper Ball Joint  
(Ø13.6)



**FO1712**

Upper Control Arm  
Hi Trail



**FO1811**

Upper Control Arm Bush



**FO1713**

Upper Control Arm  
Hi Trail



**FO1611**

Upper Ball Joint  
(Ø13.6)



**FO2711**

Repair Kit



**FO1722**

Upper Control Arm



**FO1810**

Upper Control Arm Bush



**FO1723**

Upper Control Arm



**FO2711**

Repair Kit



**FO1611**

Upper Ball Joint  
(Ø13.6)



**FO1714**

Upper Control Arm  
Std Body

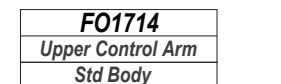

**FO1811**

Upper Control Arm Bush



**FO1715**

Upper Control Arm  
Std Body

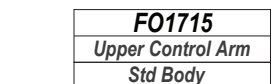

**FO1611**

Upper Ball Joint  
(Ø13.6)



**LEFT**

**RIGHT**

**FORD**

**RANGER**

**FRONT**

**ALL MODELS**

*Year*

**2008-2011**

**FO1915**

Lower Ball Joint  
(Ø17.75)



**F02115**

Lower Control Arm Bush



**FO1915**

Lower Ball Joint  
(Ø17.75)



**FO1917**

Lower Ball Joint  
(Ø17.8)



**CA2110**

Lower Control Arm Bush



**FO1917**

Lower Ball Joint  
(Ø17.8)



**F02022**

Lower Control Arm



**F02023**

Lower Control Arm

**FO1929**

Lower Ball Joint  
(Ø19.5)



**F02062**

Lower Control Arm



**F02063**

Lower Control Arm

**FO1929**

Lower Ball Joint  
(Ø19.5)



**CA2110**

Lower Control Arm Bush



**F02411**

Idler Arm  
10 mm Hole



**F02412**

Idler Arm  
14 mm Hole



**F02413**

Idler Arm  
14 mm Hole / Opp Bracket



**F02510**

Pitman Arm



**LEFT**

**RIGHT**

**FORD**

**RANGER**

**FRONT**

**T6**

**Year**

**2011-**

**FO1047**  
Outer Tie Rod End  
(Ø14.3\*Ø17.5/M14\*1.5)



**FO1333**  
Outer Tie Rod End Set  
(Ø14.3\*Ø17.5/M14\*1.5)

**FO1437**  
Rack End  
(16\*1.5/14\*1.5/203)



**FO1048**  
Outer Tie Rod End  
(Ø14.3\*Ø17.5/M14\*1.5)



**FO1049**  
Outer Tie Rod End  
(Ø11.7\*Ø14.6/M12\*1.25)



**FO1334**  
Outer Tie Rod End Set  
(Ø11.7\*Ø14.6/M12\*1.25)

**FO1415**  
Rack End  
(14\*1.5/14\*1.5/201)



**FO1050**  
Outer Tie Rod End  
(Ø11.7\*Ø14.6/M12\*1.25)

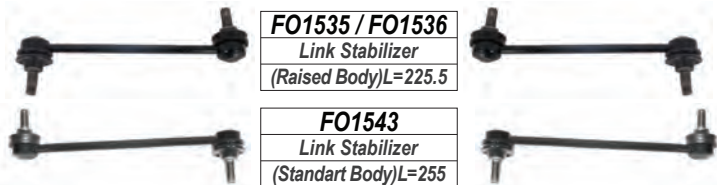

**FO1535 / FO1536**  
Link Stabilizer  
(Raised Body)L=225.5

**FO1543**  
Link Stabilizer  
(Standart Body)L=255



**FO1812**  
Upper Control Arm Bush

**FO1716**  
Upper Control Arm  
(Long)

**FO1717**  
Upper Control Arm  
(Long)

**FO1610**  
Upper Ball Joint  
(Ø18)

**FO1610**  
Upper Ball Joint  
(Ø18)



**FO1812**  
Upper Control Arm Bush

**FO1724**  
Upper Control Arm  
(Short)

**FO1725**  
Upper Control Arm  
(Short)



**FO2144**  
Lower Control Arm Bush

**FO2064**  
Lower Control Arm

**FO2065**  
Lower Control Arm

**FO1930**  
Lower Ball Joint  
(Ø26.1)

**FO1930**  
Lower Ball Joint  
(Ø26.1)

**FO2135**  
Lower Control Arm Bush

**LEFT**

**RIGHT**

**FORD**

**SIERRA.SAPPHIRE FRONT**

**ALL MODELS**

*Year*

**1983-1993**

**FO1033**  
Outer Tie Rod End  
(Ø12.6\*Ø14.6/M14\*2)

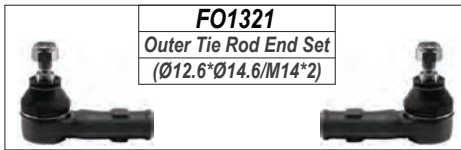

**FO1321**  
Outer Tie Rod End Set  
(Ø12.6\*Ø14.6/M14\*2)

**FO1034**  
Outer Tie Rod End  
(Ø12.6\*Ø14.6/M14\*2)

**FO1416**  
Rack End  
(14\*1.5/14\*2.0/276)



**FO2136**  
Lower Control Arm Bush



**FO2111**  
Lower Control Arm Bush

**FO2136**  
Lower Control Arm Bush

**FO2066**  
Lower Control Arm

**FO2067**  
Lower Control Arm

**LEFT**

**RIGHT**



**FORD**

**SPECTRON**

**FRONT**

**2.2 BUS.P/VAN**

*Year*

**1991-2002**

**F01019**  
Outer Tie Rod End  
(Ø14\*Ø16/M14\*1.5)

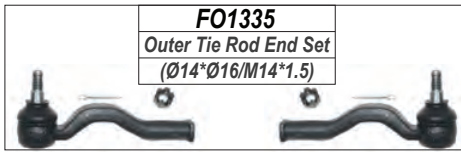

**F01335**  
Outer Tie Rod End Set  
(Ø14\*Ø16/M14\*1.5)

**F01019**  
Outer Tie Rod End  
(Ø14\*Ø16/M14\*1.5)



**F01417**  
Rack End  
(17\*1.0/14\*1.5/182)

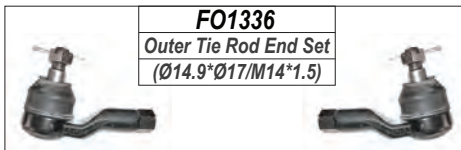

**F01336**  
Outer Tie Rod End Set  
(Ø14.9\*Ø17/M14\*1.5)

**F01020**  
Outer Tie Rod End  
(Ø14.9\*Ø17/M14\*1.5)



**F01020**  
Outer Tie Rod End  
(Ø14.9\*Ø17/M14\*1.5)



**F01612**  
Upper Ball Joint  
(Ø17.85)



**F01718**  
Upper Control Arm



**F01719**  
Upper Control Arm

**F01612**  
Upper Ball Joint  
(Ø17.85)



**F01931**  
Lower Ball Joint  
(Ø19.75)



**F02068**  
Lower Control Arm



**F02069**  
Lower Control Arm

**F01931**  
Lower Ball Joint  
(Ø19.75)



**LEFT**

**RIGHT**



**FORD**

**TELSTAR**

**FRONT**

**ALL MODELS**

*Year*

**1993-1998**

**FO1021**  
Outer Tie Rod End  
(Ø12.85\*Ø15.05/M14\*1.5)

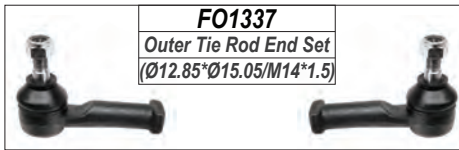

**FO1337**  
Outer Tie Rod End Set  
(Ø12.85\*Ø15.05/M14\*1.5)

**FO1418**  
Rack End  
(18\*1.5/14\*1.5/307)



**FO1021**  
Outer Tie Rod End  
(Ø12.85\*Ø15.05/M14\*1.5)



**FO1537 / FO1538**  
Link Stabilizer  
L=104.5



**FO1932**  
Lower Ball Joint  
(Ø18)



**FO2070**  
Lower Control Arm

**FO2071**  
Lower Control Arm

**FO1932**  
Lower Ball Joint  
(Ø18)



**FO2137 / FO2138**  
Lower Control Arm Bush



**TELSTAR**

**REAR**

**FO1539**  
Link Stabilizer  
L=88



**MA2815**  
Shock Mounting



**MA2816**  
Shock Mounting



**LEFT**

**RIGHT**

**FORD**

**TERRITORY**

**FRONT**

**ALL MODELS**

Year

**2005-**

**FO1022**  
Outer Tie Rod End  
(Ø14.15\*Ø15.9/M16\*1.5)

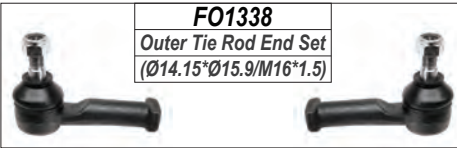

**FO1338**  
Outer Tie Rod End Set  
(Ø14.15\*Ø15.9/M16\*1.5)

**FO1023**  
Outer Tie Rod End  
(Ø14.15\*Ø15.9/M16\*1.5)



**FO1419**  
Rack End  
(16\*1.5/16\*1.5/308)



**FO1540**  
Link Stabilizer  
L=317



**FO1613**  
Upper Ball Joint  
(Ø18)



**FO1813**  
Upper Control Arm Bush

**FO1720**  
Upper Control Arm

**FO1721**  
Upper Control Arm

**FO1613**  
Upper Ball Joint  
(Ø18)



**FO1933**  
Lower Ball Joint  
(Ø17.3)



**FO2072**  
Lower Control Arm

**FO2073**  
Lower Control Arm

**FO2139**  
Lower Control Arm Bush

**FO1933**  
Lower Ball Joint  
(Ø17.3)



**FO2074**  
Lower Control Arm



**FO2075**  
Lower Control Arm

**LEFT**

**RIGHT**

**FORD**

**TOURNEO/TRANSIT CONNECT FRONT**

**ALL MODELS**

Year

**2015-**

**FO1043**  
Outer Tie Rod End  
(Ø12.35\*Ø16.1/M16\*1.5)

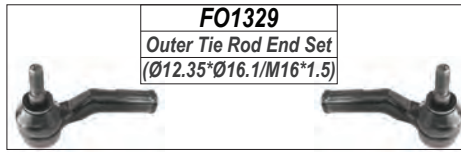

**FO1329**  
Outer Tie Rod End Set  
(Ø12.35\*Ø16.1/M16\*1.5)

**FO1044**  
Outer Tie Rod End  
(Ø12.35\*Ø16.1/M16\*1.5)



**FO1431**  
Rack End  
(14\*1.5/16\*1.5/290)



**FO1522**  
Link Stabilizer  
L=298



**FO2048**  
Lower Control Arm  
Metal

**FO2049**  
Lower Control Arm  
Metal

**FO2129**  
Lower Control Arm Bush

**FO2128**  
Lower Control Arm Bush

**LEFT**

**RIGHT**

**FORD**

**TOURNEO/TRANSIT FRONT**

Year

**ALL MODELS**

**2013-**

**FO1024**  
Outer Tie Rod End  
(Ø16.7\*Ø20.2/M16\*1.5)

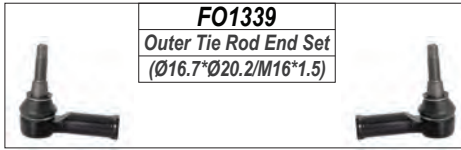

**FO1339**  
Outer Tie Rod End Set  
(Ø16.7\*Ø20.2/M16\*1.5)

**FO1420**  
Rack End  
(16\*1.5/16\*1.5/380)



**FO1024**  
Outer Tie Rod End  
(Ø16.7\*Ø20.2/M16\*1.5)



**FO1541**  
Link Stabilizer  
L=290



**FO2141**  
Lower Control Arm Bush

**FO1911**  
Lower Ball Joint  
(Ø18.6)



**FO2076**  
Lower Control Arm

**FO2077**  
Lower Control Arm

**FO1911**  
Lower Ball Joint  
(Ø18.6)



**FO2140**  
Lower Control Arm Bush



**LEFT**

**RIGHT**

**FOTON**

VIEW

FRONT

2.2

Year

2007-

**CA1010**  
Outer Tie Rod End  
(Ø14.6\*Ø16.5/M17\*1.5)

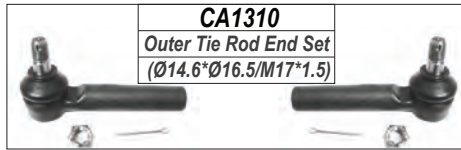

**CA1310**  
Outer Tie Rod End Set  
(Ø14.6\*Ø16.5/M17\*1.5)

**CA1410**  
Rack End  
(14\*1.5/17\*1.5/276)

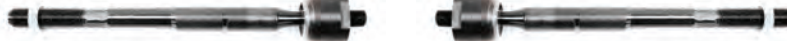

**CA1010**  
Outer Tie Rod End  
(Ø14.6\*Ø16.5/M17\*1.5)



**CA1011**  
Outer Tie Rod End  
(Ø14.7\*Ø16/M15\*1.5)

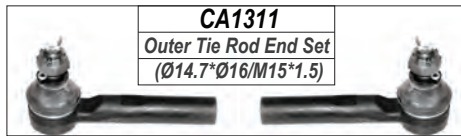

**CA1311**  
Outer Tie Rod End Set  
(Ø14.7\*Ø16/M15\*1.5)

**CA1411**  
Rack End  
(14\*1.5/15\*1.5/274)



**CA1011**  
Outer Tie Rod End  
(Ø14.7\*Ø16/M15\*1.5)



**CA1611**  
Upper Ball Joint  
(Ø17.5)



**FT1710**  
Upper Control Arm



**FT1711**  
Upper Control Arm



**CA1611**  
Upper Ball Joint  
(Ø17.5)

**FT1910**  
Lower Ball Joint  
(Ø16.8)



**TO2130**  
Lower Control Arm Bush



**CA2010**  
Lower Control Arm



**CA2011**  
Lower Control Arm



**FT1910**  
Lower Ball Joint  
(Ø16.8)

**CA1910**  
Lower Ball Joint  
(Ø18)



**CA1910**  
Lower Ball Joint  
(Ø18)

LEFT

RIGHT



**FOTON**

**INKUNZI**

**FRONT**

**2.2**

*Year*

**2007-**

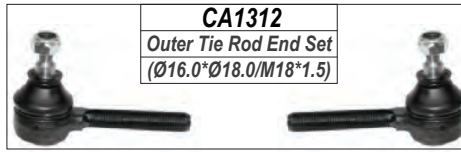

**CA1312**  
Outer Tie Rod End Set  
(Ø16.0\*Ø18.0/M18\*1.5)

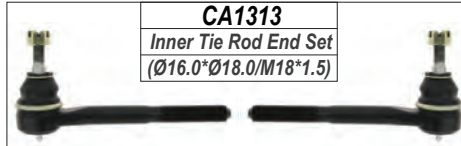

**CA1313**  
Inner Tie Rod End Set  
(Ø16.0\*Ø18.0/M18\*1.5)

**CA1012**  
Outer Tie Rod End  
(Ø16.0\*Ø18.0/M18\*1.5)



**CA1110**  
Outer Tie Rod End  
(Ø16.0\*Ø18.0/M18\*1.5)



**CA1012**  
Outer Tie Rod End  
(Ø16.0\*Ø18.0/M18\*1.5)



**CA1610**  
Upper Ball Joint  
(Ø17)



**CA1710**  
Upper Control Arm

**CA1710**  
Upper Control Arm

**CA1610**  
Upper Ball Joint  
(Ø17)



**CA1911**  
Lower Ball Joint  
(Ø18)



**CA2012**  
Lower Control Arm



**CA2013**  
Lower Control Arm



**CA2110**  
Lower Control Arm Bush

**CA1911**  
Lower Ball Joint  
(Ø18)



**LEFT**

**RIGHT**

**FOTON**

**THUNDA**

**FRONT**

**2.8**

**Year**

**2010-**

**FT1010**  
Outer Tie Rod End  
(Ø16.1\*Ø18/M14\*1.5)

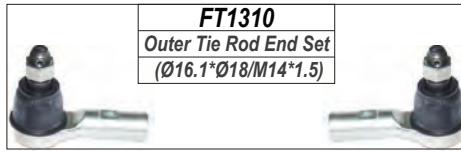

**FT1310**  
Outer Tie Rod End Set  
(Ø16.1\*Ø18/M14\*1.5)

**FT1410**  
Rack End  
(14\*1.5/14\*1.5/296)



**FT1010**  
Outer Tie Rod End  
(Ø16.1\*Ø18/M14\*1.5)



**FT1510 / FT1511**  
Link Stabilizer  
L=155



**FT1610**  
Upper Ball Joint  
(Ø17.56)



**FT1610**  
Upper Ball Joint  
(Ø17.56)

**FT1712**  
Upper Control Arm

**FT1713**  
Upper Control Arm

**FT1611**  
Upper Ball Joint  
(Ø17.6)



**FT1714**  
Upper Control Arm



**FT1715**  
Upper Control Arm

**FT1611**  
Upper Ball Joint  
(Ø17.6)



**FT1911**  
Lower Ball Joint  
(Ø20.6)



**FT2010**  
Lower Control Arm



**FT2011**  
Lower Control Arm

**FT1911**  
Lower Ball Joint  
(Ø20.6)

**LEFT**

**RIGHT**

**GONOW**

X-SPACE/STEED

FRONT

2.2

Year

2007-

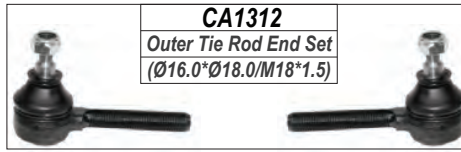

**CA1312**  
Outer Tie Rod End Set  
(Ø16.0\*Ø18.0/M18\*1.5)

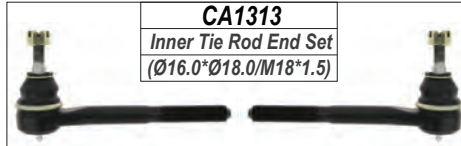

**CA1313**  
Inner Tie Rod End Set  
(Ø16.0\*Ø18.0/M18\*1.5)

**CA1012**  
Outer Tie Rod End  
(Ø16.0\*Ø18.0/M18\*1.5)



**CA1110**  
Outer Tie Rod End  
(Ø16.0\*Ø18.0/M18\*1.5)



**CA1012**  
Outer Tie Rod End  
(Ø16.0\*Ø18.0/M18\*1.5)



**CA1610**  
Upper Ball Joint  
(Ø17)



**CA1710**  
Upper Control Arm



**CA1710**  
Upper Control Arm

**CA1610**  
Upper Ball Joint  
(Ø17)



**CA1911**  
Lower Ball Joint  
(Ø18)



**CA2012**  
Lower Control Arm



**CA2013**  
Lower Control Arm

**CA1911**  
Lower Ball Joint  
(Ø18)



**CA2110**  
Lower Control Arm Bush

LEFT

RIGHT

**GWM**

**STEED 3,5**

**FRONT**

**ALL**

**Year**

**2009-**

**FT1010**  
Outer Tie Rod End  
(Ø16.1\*Ø18/M14\*1.5)

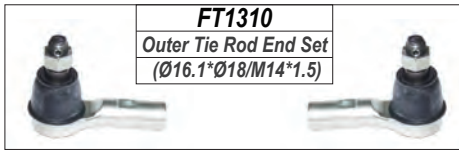

**FT1310**  
Outer Tie Rod End Set  
(Ø16.1\*Ø18/M14\*1.5)

**FT1010**  
Outer Tie Rod End  
(Ø16.1\*Ø18/M14\*1.5)



**FT1410**  
Rack End  
(14\*1,5/14\*1,5/296)



**FT1510 / FT1511**  
Link Stabilizer  
L=155



**FT1610**  
Upper Ball Joint  
(Ø17.56)



**FT1712**  
Upper Control Arm

**FT1713**  
Upper Control Arm

**FT1610**  
Upper Ball Joint  
(Ø17.56)



**FT1611**  
Upper Ball Joint  
(Ø17.6)



**FT1714**  
Upper Control Arm

**FT1715**  
Upper Control Arm

**FT1611**  
Upper Ball Joint  
(Ø17.6)



**FT1911**  
Lower Ball Joint  
(Ø17.6)



**FT2010**  
Lower Control Arm

**FT2011**  
Lower Control Arm

**FT1911**  
Lower Ball Joint  
(Ø17.6)



**IS2014**  
Lower Control Arm  
STD-BODY

**IS2015**  
Lower Control Arm  
STD-BODY

**LEFT RIGHT**



**HONDA**

**ACCORD**

**FRONT**

**VII**

*Year*

**2003-2008**

**HO1010**  
Outer Tie Rod End  
(Ø12.6\*Ø14.1/M14\*1.5)



**HO1310**  
Outer Tie Rod End Set  
(Ø12.6\*Ø14.1/M14\*1.5)



**HO1011**  
Outer Tie Rod End  
(Ø12.6\*Ø14.1/M14\*1.5)



**HO1410**  
Rack End  
(18\*1.5/14\*1.5/124)

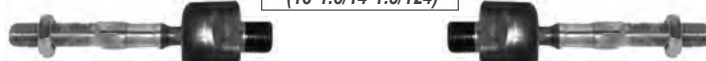

**HO1412**  
Rack End  
(16\*1.5/14\*1.5/143)

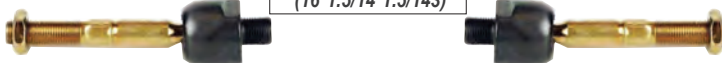

**HO1510 / HO1511**  
Link Stabilizer  
L=80



**HO1512 / HO1513**  
Link Stabilizer  
L=72

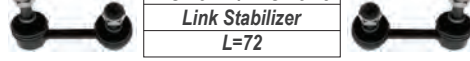

**HO1610**  
Upper Ball Joint  
(Ø12.75)

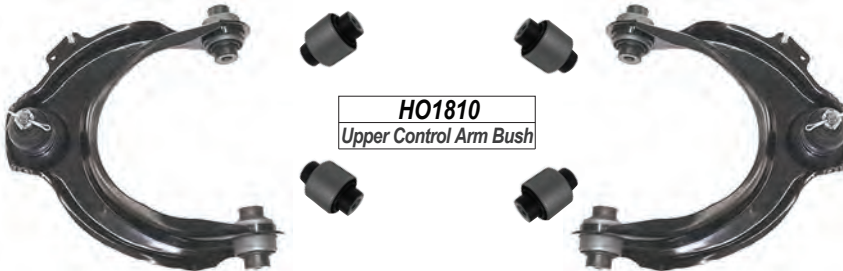

**HO1810**  
Upper Control Arm Bush



**HO1610**  
Upper Ball Joint  
(Ø12.75)



**HO1710**  
Upper Control Arm

**HO1711**  
Upper Control Arm

**HO1911**  
Lower Ball Joint  
(Ø17.35)



**HO1911**  
Lower Ball Joint  
(Ø17.35)



**HO2111**  
Lower Control Arm Bush



**HO2112**  
Lower Control Arm Bush



**HO2111**  
Lower Control Arm Bush



**HO2010**  
Lower Control Arm

**HO2011**  
Lower Control Arm

**HO2810**  
Shock Mounting



**HO2810**  
Shock Mounting



**ACCORD**

**REAR**

**HO2810**  
Shock Mounting



**HO1514 / HO1515**  
Link Stabilizer  
L=115

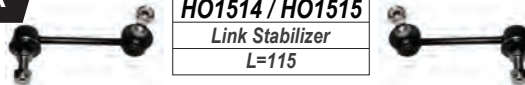

**HO2810**  
Shock Mounting



**LEFT**

**RIGHT**



**HONDA**

**ACCORD**

**FRONT**

**VIII**

*Year*

**2008-2014**

**HO1311**  
Outer Tie Rod End Set  
(Ø13.6\*Ø15.1/M14\*1.5)

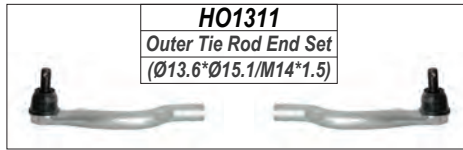

**HO1026**  
Outer Tie Rod End  
(Ø13.6\*Ø15.1/M14\*1.5)



**HO1413**  
Rack End  
(18\*1.5/14\*1.5/131)



**HO1027**  
Outer Tie Rod End  
(Ø13.6\*Ø15.1/M14\*1.5)



**HO1510 / HO1511**  
Link Stabilizer  
L=80



**HO1516 / HO1517**  
Link Stabilizer  
L=81



**HO1611**  
Upper Ball Joint  
(Ø12.48)

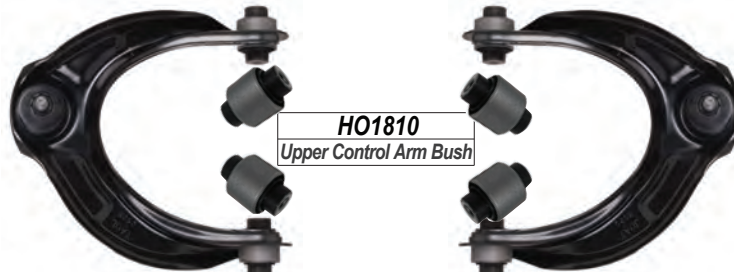

**HO1810**  
Upper Control Arm Bush

**HO1611**  
Upper Ball Joint  
(Ø12.48)



**HO1712**  
Upper Control Arm

**HO1713**  
Upper Control Arm

**HO1912**  
Lower Ball Joint  
(Ø19.24)



**HO2112**  
Lower Control Arm Bush

**HO1912**  
Lower Ball Joint  
(Ø19.24)



**HO2012**  
Lower Control Arm

**HO2013**  
Lower Control Arm

**ACCORD**

**REAR**

**HO1518 / HO1519**  
Link Stabilizer  
L=145



**LEFT**

**RIGHT**

**HONDA**

**BALLADE**

**FRONT**

**(FLIP-UP LIGHT).PRELUDE**

*Year*

**1984-1989**

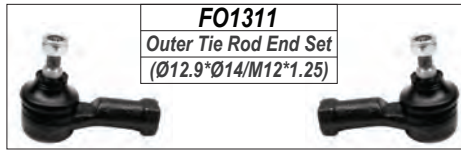

<b>FO1311</b>
Outer Tie Rod End Set
(Ø12.9*Ø14/M12*1.25)

<b>FO1026</b>
Outer Tie Rod End
(Ø12.9*Ø14/M12*1.25)

<b>HO1414</b>
Rack End
(12*1.25/12*1.25/276)

<b>FO1026</b>
Outer Tie Rod End
(Ø12.9*Ø14/M12*1.25)



<b>HO2016</b>
Lower Control Arm



<b>HO2017</b>
Lower Control Arm

**LEFT**

**RIGHT**

**HONDA**

**BALLADE**

**FRONT**

**SH4**

*Year*

**1989-1992**

**HO1312**  
Outer Tie Rod End Set  
(Ø13\*Ø14.2/M14\*1.5)



**HO1415**  
Rack End  
(12\*1.25/14\*1.5/168)



**HO1012**  
Outer Tie Rod End  
(Ø13\*Ø14.2/M14\*1.5)



**HO1013**  
Outer Tie Rod End  
(Ø13\*Ø14.2/M14\*1.5)



**HO1416**  
Rack End  
(12\*1.25/14\*1.5/161)



**HO1520**  
Link Stabilizer  
L=56

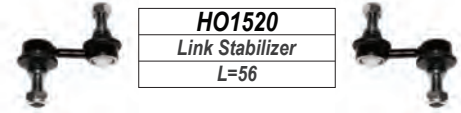

**HO1610**  
Upper Ball Joint  
(Ø12.75)



**HO1610**  
Upper Ball Joint  
(Ø12.75)

**HO1714**  
Upper Control Arm

**HO1715**  
Upper Control Arm

**HO1913**  
Lower Ball Joint  
(Ø14.4)



**HO2113**  
Lower Control Arm Bush



**HO2113**  
Lower Control Arm Bush



**HO1913**  
Lower Ball Joint  
(Ø14.4)



**HO2018**  
Lower Control Arm

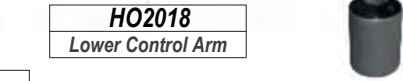

**HO2019**  
Lower Control Arm



**HO2811**  
Shock Mounting



**HO2114**  
Lower Control Arm Bush



**HO2811**  
Shock Mounting



**BALLADE**

**REAR**

**HO1521 / HO1522**  
Link Stabilizer  
L=83



**LEFT**

**RIGHT**

**HONDA**

**BALLADE**

**FRONT**

**SR4.S04**

*Year*

**1992-2000**

**HO1012**  
Outer Tie Rod End  
(Ø13\*Ø14.2/M14\*1.5)



**HO1312**  
Outer Tie Rod End Set  
(Ø13\*Ø14.2/M14\*1.5)

**HO1415**  
Rack End  
(12\*1.25/14\*1.5/168)



**HO1013**  
Outer Tie Rod End  
(Ø13\*Ø14.2/M14\*1.5)

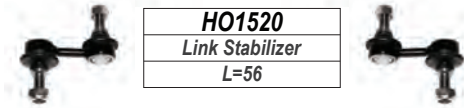

**HO1520**  
Link Stabilizer  
L=56

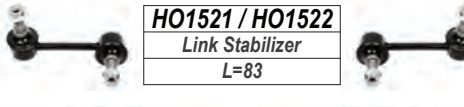

**HO1521 / HO1522**  
Link Stabilizer  
L=83



**HO1716(SR4)**  
Upper Control Arm

**HO1717(SR4)**  
Upper Control Arm

**HO1610**  
Upper Ball Joint  
(Ø12.75)



**HO1610**  
Upper Ball Joint  
(Ø12.75)



**HO1718(S04)**  
Upper Control Arm

**HO1719(S04)**  
Upper Control Arm

**HO1913**  
Lower Ball Joint  
(Ø14.4)



**HO2020**  
Lower Control Arm

**HO2021**  
Lower Control Arm

**HO1913**  
Lower Ball Joint  
(Ø14.4)



**HO2113**  
Lower Control Arm Bush

**HO2113**  
Lower Control Arm Bush

**HO2115**  
Lower Control Arm Bush

**HO2812**  
Shock Mounting



**HO2813**  
Shock Mounting



**HO2813**  
Shock Mounting



**HO2812**  
Shock Mounting



**BALLADE**

**REAR**

**HO2910**  
Trailing Arm Bush

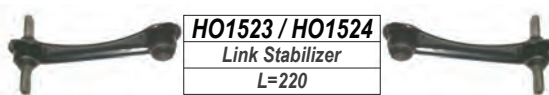

**HO1523 / HO1524**  
Link Stabilizer  
L=220

**HO2910**  
Trailing Arm Bush



**LEFT**

**RIGHT**

**HONDA**

**BALLADE**

**FRONT**

**ALL MODELS**

*Year*

**2011-**

**HO1028**  
Outer Tie Rod End  
(Ø12.7\*Ø14/M14\*1.5)

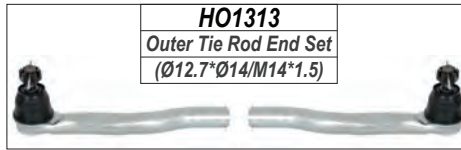

**HO1313**  
Outer Tie Rod End Set  
(Ø12.7\*Ø14/M14\*1.5)

**HO1418**  
Rack End  
(18\*1.5/14\*1.5/235)



**HO1029**  
Outer Tie Rod End  
(Ø12.7\*Ø14/M14\*1.5)



**HO1525**  
Link Stabilizer  
L=324.5



**HO1914**  
Lower Ball Joint  
(Ø17.5)



**HO2022**  
Lower Control Arm

**HO2023**  
Lower Control Arm

**HO1914**  
Lower Ball Joint  
(Ø17.5)



**HO2814**  
Shock Mounting



**HO2814**  
Shock Mounting



**LEFT**

**RIGHT**



**HONDA**

**BRIO**

**FRONT**

**ALL MODELS**

*Year*

**2012-**

**HO1313**  
Outer Tie Rod End Set  
(Ø12.7\*Ø14/M14\*1.5)

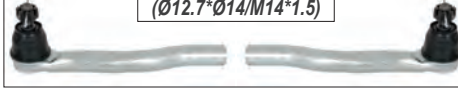

**HO1028**  
Outer Tie Rod End  
(Ø12.7\*Ø14/M14\*1.5)



**HO1418**  
Rack End  
(18\*1.5/14\*1.5/235)



**HO1029**  
Outer Tie Rod End  
(Ø12.7\*Ø14/M14\*1.5)



**HO1525**  
Link Stabilizer  
L=324.5



**HO1914**  
Lower Ball Joint  
(Ø17.5)



**HO2022**  
Lower Control Arm

**HO2023**  
Lower Control Arm

**HO1914**  
Lower Ball Joint  
(Ø17.5)



**HO2814**  
Shock Mounting



**HO2814**  
Shock Mounting



**LEFT**

**RIGHT**

**HONDA**

**BRIO AMAZE**

**FRONT**

**ALL MODELS**

*Year*

**2012-**

**HO1030**  
Outer Tie Rod End

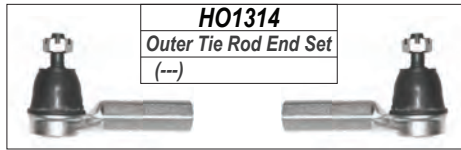

**HO1314**  
Outer Tie Rod End Set  
(---)

**HO1431**  
Rack End  
(14\*1.5/12\*1.25/292)

**HO1030**  
Outer Tie Rod End



**HO1419**  
Rack End



**HO1525**  
Link Stabilizer  
L=324,5



**HO1915**  
Lower Ball Joint



**HO2024**  
Lower Control Arm



**HO2025**  
Lower Control Arm



**HO1915**  
Lower Ball Joint

**HO2814**  
Shock Mounting



**HO2814**  
Shock Mounting



**LEFT**

**RIGHT**

**HONDA**

CIVIC

FRONT

SO3

Year

1996-2001

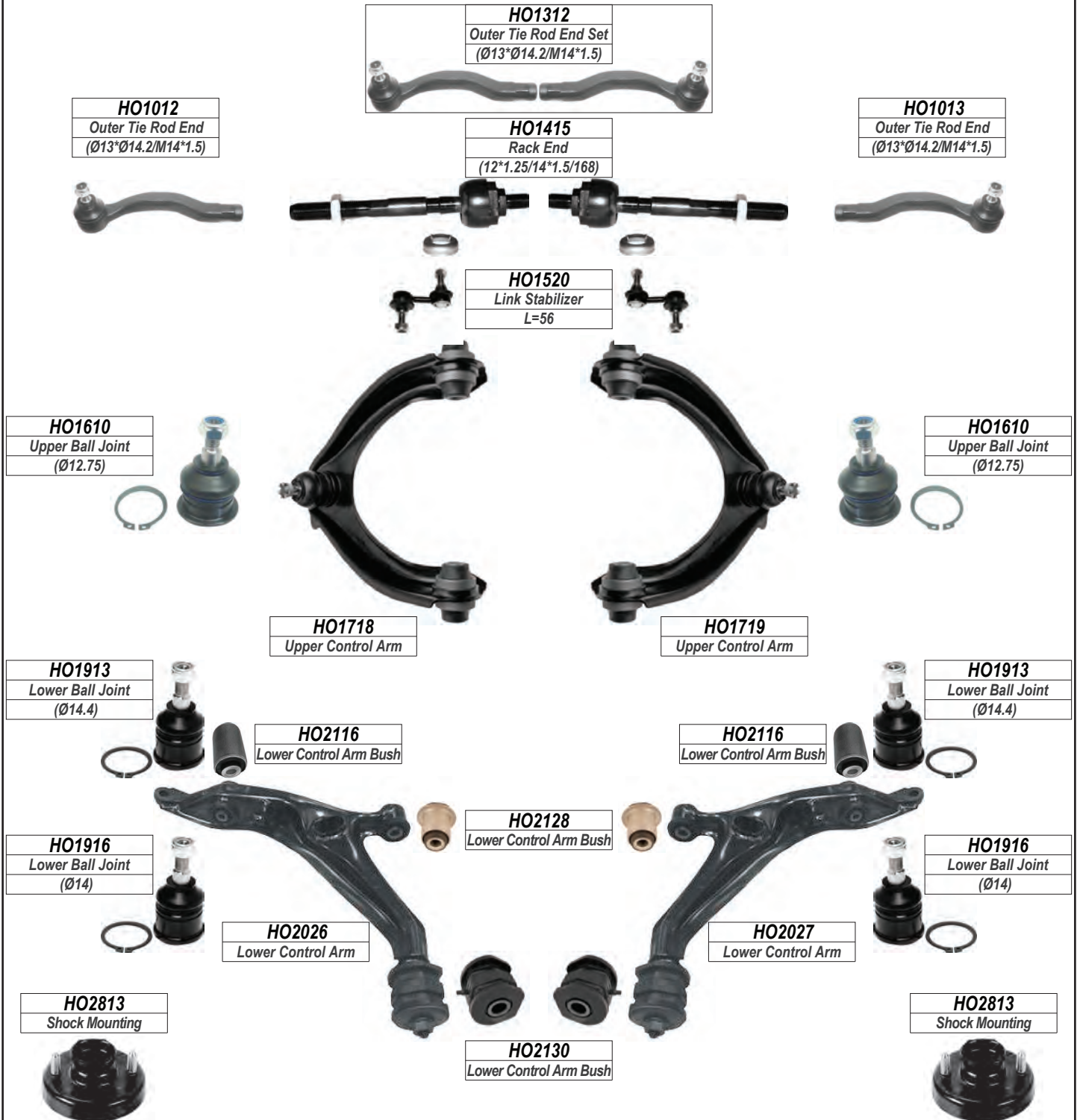

CIVIC

REAR

**HO1521 / HO1522**

Link Stabilizer  
L=83

**HO2910**

Tariling Arm Bush

**HO2910**

Tariling Arm Bush

**HO1523 / HO1524**

Link Stabilizer  
L=220



LEFT

RIGHT

**HONDA**

CIVIC

FRONT

VI.V-TEC.

Year

2001-2005

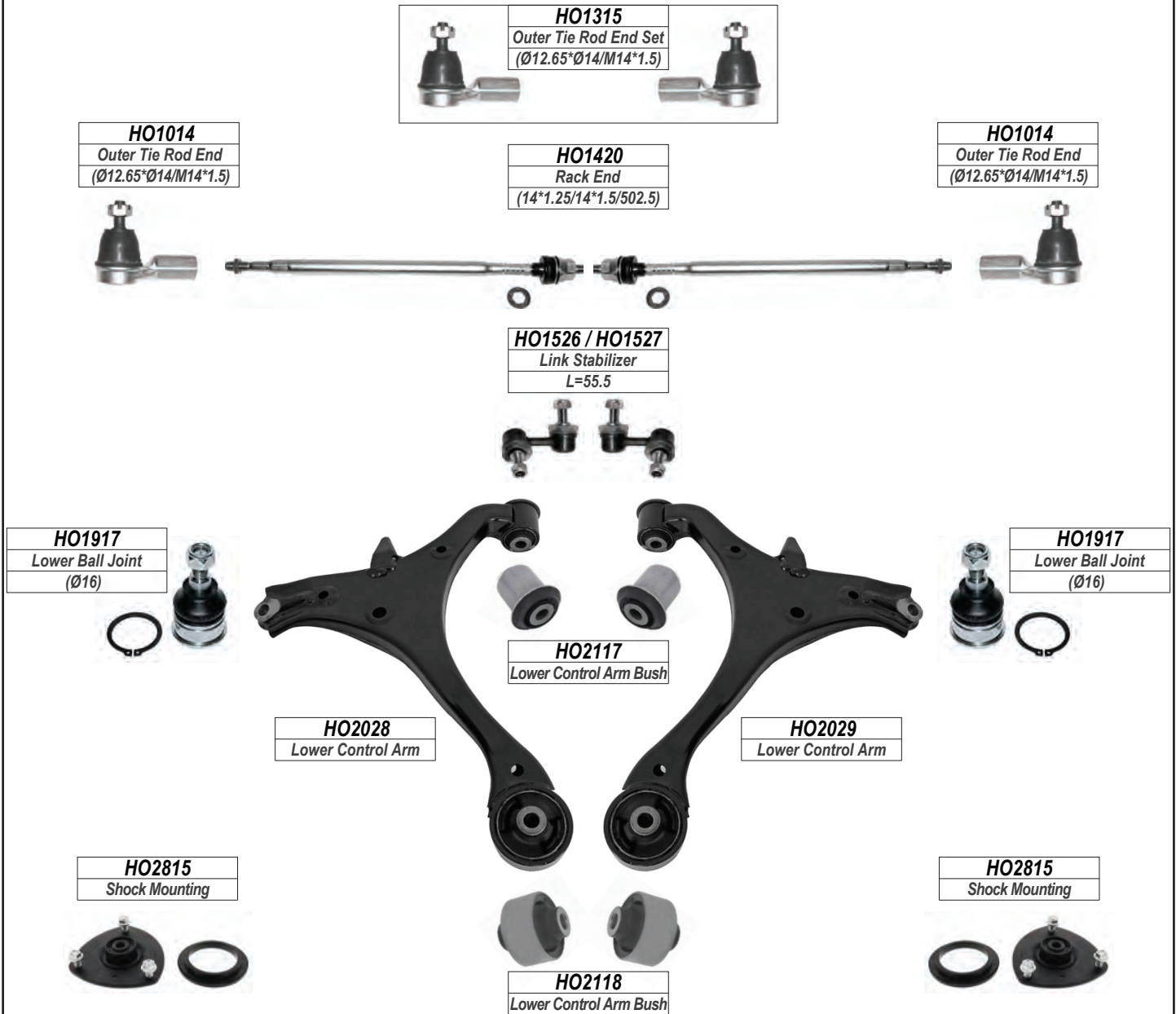

**CIVIC** **REAR**

**HO1528 / HO1529**  
Link Stabilizer  
L=72.5

**HO2816**  
Shock Mounting

**HO2816**  
Shock Mounting



**LEFT**

**RIGHT**

**HONDA**

**CIVIC**

**FRONT**

**VII.I-VTEC.R. VIII SALOON. HATCHBACK**

*Year*

**2005-2012**

**HO1015**  
Outer Tie Rod End  
(Ø13.73\*Ø15.1/M14\*1.5)

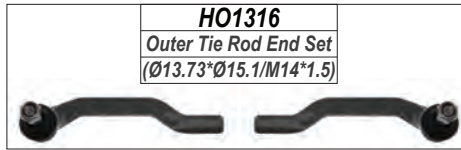

**HO1316**  
Outer Tie Rod End Set  
(Ø13.73\*Ø15.1/M14\*1.5)

**HO1016**  
Outer Tie Rod End  
(Ø13.73\*Ø15.1/M14\*1.5)

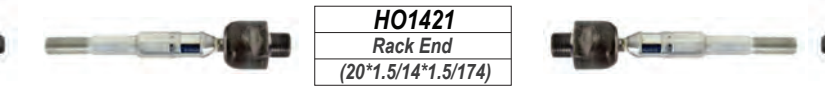

**HO1421**  
Rack End  
(20\*1.5/14\*1.5/174)

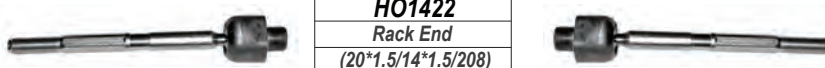

**HO1422**  
Rack End  
(20\*1.5/14\*1.5/208)



**HO1424**  
Rack End  
(18\*1.5/14\*1.5/175)



**HO1530**  
Link Stabilizer  
L=225.5



**HO1531 / HO1532**  
Link Stabilizer  
L=71

**HO1918**  
Lower Ball Joint  
(Ø17.4)



**HO2032**  
Lower Control Arm

**HO2033**  
Lower Control Arm

**HO1919**  
Lower Ball Joint  
(Ø17.4)



**HO2030**  
Lower Control Arm



**HO2031**  
Lower Control Arm



**HO2119**  
Lower Control Arm Bush

**CIVIC**

**REAR**

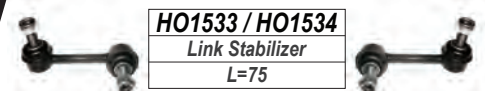

**HO1533 / HO1534**  
Link Stabilizer  
L=75

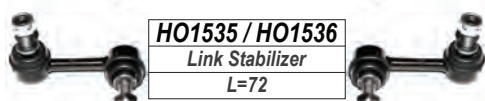

**HO1535 / HO1536**  
Link Stabilizer  
L=72

**LEFT**

**RIGHT**



**HONDA**

**CIVIC**

**FRONT**

**IX (FK)**

*Year*

**2012-**

**HO1017**  
Outer Tie Rod End  
(Ø13.6\*Ø15/M14\*1.5)

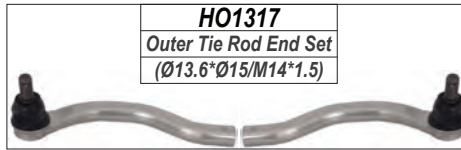

**HO1317**  
Outer Tie Rod End Set  
(Ø13.6\*Ø15/M14\*1.5)

**HO1425**  
Rack End  
(20\*1.5/14\*1.5/189)



**HO1018**  
Outer Tie Rod End  
(Ø13.6\*Ø15/M14\*1.5)



**HO1537 / HO1538**  
Link Stabilizer  
L=325



**HO2121**  
Lower Control Arm Bush



**HO1920**  
Lower Ball Joint  
(Ø15.5)



**HO2034**  
Lower Control Arm

**HO2035**  
Lower Control Arm

**HO1920**  
Lower Ball Joint  
(Ø15.5)



**HO2120**  
Lower Control Arm Bush



**LEFT**

**RIGHT**

**HONDA**

CR-V

FRONT

Year

1997-2002

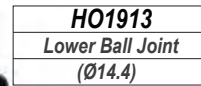
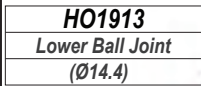
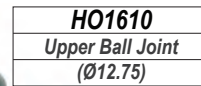
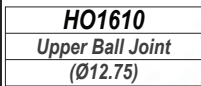
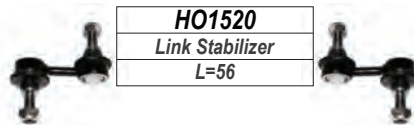
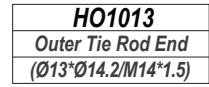
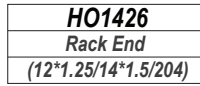
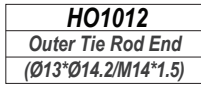
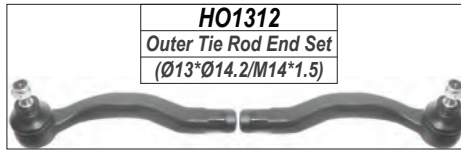

CRV

REAR



LEFT

RIGHT

**HONDA**

CR-V

FRONT

Year

2002-2007

II

**HO1014**  
Outer Tie Rod End  
(Ø12.65\*Ø14/M14\*1.5)

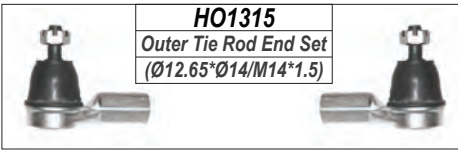

**HO1315**  
Outer Tie Rod End Set  
(Ø12.65\*Ø14/M14\*1.5)

**HO1427**  
Rack End  
(14\*1.25/14\*1.5/545)

**HO1014**  
Outer Tie Rod End  
(Ø12.65\*Ø14/M14\*1.5)



**HO1526 / HO1527**  
Link Stabilizer  
L=55.5



**HO1610**  
Upper Ball Joint  
(Ø12.75)



**HO1610**  
Upper Ball Joint  
(Ø12.75)



**HO1921**  
Lower Ball Joint  
(Ø15.5)



**HO1921**  
Lower Ball Joint  
(Ø15.5)

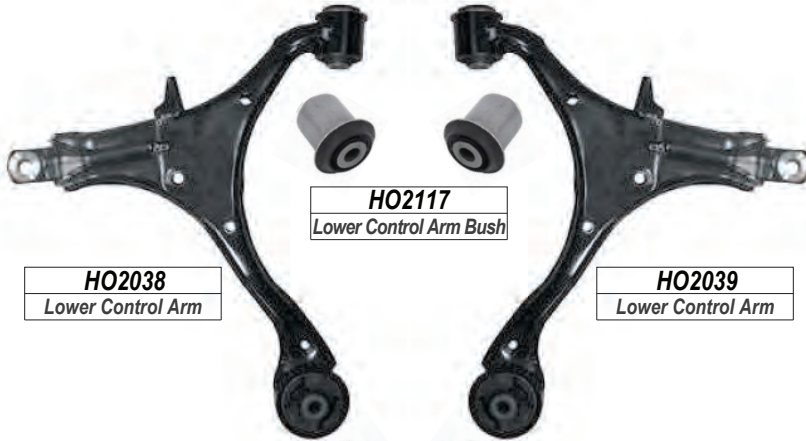

**HO2117**  
Lower Control Arm Bush

**HO2038**  
Lower Control Arm

**HO2039**  
Lower Control Arm

**HO2129**  
Lower Control Arm Bush

**HO2815**  
Shock Mounting



**HO2815**  
Shock Mounting



CRV

REAR

**HO1541 / HO1542**  
Link Stabilizer  
L=89



**HO2816**  
Shock Mounting

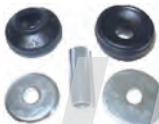

**HO2816**  
Shock Mounting



LEFT

RIGHT

**HONDA**

CR-V

FRONT

III

Year

2007-

**HO1318**  
Outer Tie Rod End Set  
(Ø13.6\*Ø15/M14\*1.5)

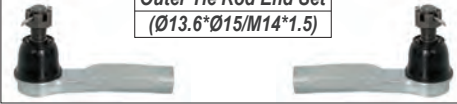

**HO1031**  
Outer Tie Rod End  
(Ø13.6\*Ø15/M14\*1.5)



**HO1031**  
Outer Tie Rod End  
(Ø13.6\*Ø15/M14\*1.5)



**HO1428**  
Rack End  
(16\*1.0/14\*1.5/316)



**HO1429**  
Rack End  
(20\*1.5/14\*1.5/319)



**HO1430**  
Rack End  
(20\*1.5/14\*1.5/262)



**HO1543**  
Link Stabilizer  
L=318



**HO2124**  
Lower Control Arm Bush



**HO2122 / HO2123**  
Lower Control Arm Bush



**HO2040**  
Lower Control Arm



**HO2041**  
Lower Control Arm



**HO1922**  
Lower Ball Joint  
(Ø17.5)



**HO1922**  
Lower Ball Joint  
(Ø17.5)



**HO2818**  
Shock Mounting



**HO2818**  
Shock Mounting



CRV

REAR

**HO2819**  
Shock Mounting



**HO1544 / HO1545**  
Link Stabilizer  
L=85



**HO2819**  
Shock Mounting



LEFT

RIGHT

**HONDA**

CR-V

FRONT

IV / V

Year

2010-

**HO1019**  
Outer Tie Rod End  
(Ø13.6\*Ø15/M14\*1.5)



**HO1319**  
Outer Tie Rod End Set  
(Ø13.6\*Ø15/M14\*1.5)

**HO1411**  
Rack End  
(16\*1.0/14\*1.5/225)



**HO1020**  
Outer Tie Rod End  
(Ø13.6\*Ø15/M14\*1.5)



**HO1543**  
Link Stabilizer  
L=318



**HO1922**  
Lower Ball Joint  
(Ø17.5)



**HO2042**  
Lower Control Arm

**HO2043**  
Lower Control Arm

**HO1922**  
Lower Ball Joint  
(Ø17.5)



**LEFT**

**RIGHT**



**HONDA**

HR-V

FRONT

ALL MODEL

Year

2002-2005

**HO1021**  
Outer Tie Rod End  
(Ø13.75\*Ø15.5/M12\*1.25)

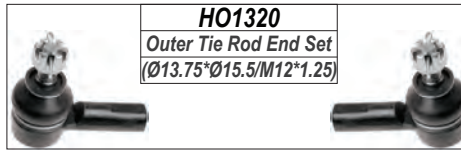

**HO1320**  
Outer Tie Rod End Set  
(Ø13.75\*Ø15.5/M12\*1.25)

**HO1431**  
Rack End  
(14\*1.5/12\*1.25/292)

**HO1021**  
Outer Tie Rod End  
(Ø13.75\*Ø15.5/M12\*1.25)



**HO1546 / HO1547**  
Link Stabilizer  
L=150



**HO1910**  
Lower Ball Joint  
(Ø14.1)



**HO1910**  
Lower Ball Joint  
(Ø14.1)

HR-V

REAR

**HO1548 / HO1549**  
Link Stabilizer  
L=150



LEFT

RIGHT

**HONDA**

**INSIGHT**

**FRONT**

**1.3.1.3HYBIRD**

*Year*

**2009-2014**

<b>HO1028</b>
Outer Tie Rod End
(Ø12.7*Ø14/M14*1.5)

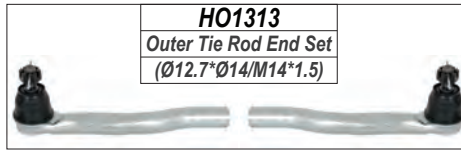

<b>HO1313</b>
Outer Tie Rod End Set
(Ø12.7*Ø14/M14*1.5)

<b>HO1418</b>
Rack End
(18*1.5/14*1.5/235)



<b>HO1029</b>
Outer Tie Rod End
(Ø12.7*Ø14/M14*1.5)



<b>HO1525</b>
Link Stabilizer
L=324.5



**LEFT**

**RIGHT**

**HONDA**

JAZZ

FRONT

II (GD)

Year

2002-2008

**HO1321**  
Outer Tie Rod End Set  
(Ø12.6\*Ø14/M12\*1.25)



**HO1022**  
Outer Tie Rod End  
(Ø12.6\*Ø14/M12\*1.25)



**HO1432**  
Rack End  
(16\*1.0/12\*1.25/211)



**HO1432**  
Rack End  
(16\*1.0/12\*1.25/212)



**HO1023**  
Outer Tie Rod End  
(Ø12.6\*Ø14/M12\*1.25)



**HO1434**  
Rack End  
(18\*1.5/12\*1.25/211)



**HO1435**  
Rack End  
(18\*1.5/12\*1.25/212)



**HO1550 / HO1551**  
Link Stabilizer  
L=300



**HO1552 / HO1553**  
Link Stabilizer  
L=320



**HO1910**  
Lower Ball Joint  
(Ø16)



**HO1910**  
Lower Ball Joint  
(Ø16)

**HO2044**  
Lower Control Arm

**HO2045**  
Lower Control Arm

**HO2814**  
Shock Mounting



**HO2814**  
Shock Mounting



**LEFT**

**RIGHT**

**HONDA**

JAZZ

FRONT

III (GE)

Year

2008-

**HO1028**  
Outer Tie Rod End  
(Ø12.7\*Ø14/M14\*1.5)

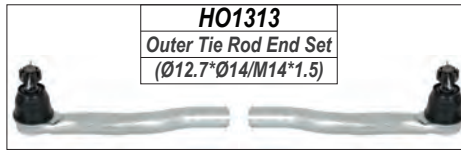

**HO1313**  
Outer Tie Rod End Set  
(Ø12.7\*Ø14/M14\*1.5)

**HO1418**  
Rack End  
(18\*1.5/14\*1.5/235)



**HO1029**  
Outer Tie Rod End  
(Ø12.7\*Ø14/M14\*1.5)



**HO1525**  
Link Stabilizer  
L=324.5



**HO2127**  
Lower Control Arm Bush



**HO1914**  
Lower Ball Joint  
(Ø17.5)



**HO2022**  
Lower Control Arm

**HO2023**  
Lower Control Arm

**HO1914**  
Lower Ball Joint  
(Ø17.5)



**HO2125 / HO2126**  
Lower Control Arm Bush



**HO2814**  
Shock Mounting



**HO2814**  
Shock Mounting



**LEFT**

**RIGHT**

**HONDA**

JAZZ

FRONT

IV (GK)

Year

2014-

**HO1032**  
Outer Tie Rod End  
(Ø12.7\*Ø14/M14\*1.5)



**HO1323**  
Outer Tie Rod End Set  
(Ø12.7\*Ø14/M14\*1.5)

**HO1437**  
Rack End  
(14\*1.5/14\*1.5/271)



**HO1033**  
Outer Tie Rod End  
(Ø12.7\*Ø14/M14\*1.5)



**HO1556 / HO1557**  
Link Stabilizer  
L=310



**HO2132**  
Lower Control Arm Bush

**HO1925**  
Lower Ball Joint  
(Ø15.5)



**HO2048**  
Lower Control Arm

**HO2049**  
Lower Control Arm

**HO1925**  
Lower Ball Joint  
(Ø15.5)



**HO2133**  
Lower Control Arm Bush



**LEFT**

**RIGHT**



**HONDA**

**MOBILIO**

**FRONT**

**ALL MODEL**

*Year*

**2013-**

**HO1028**  
Outer Tie Rod End  
(Ø12.7\*Ø14/M14\*1.5)

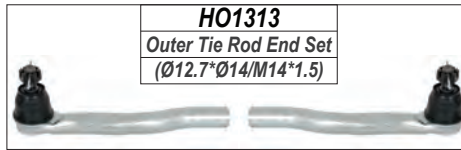

**HO1313**  
Outer Tie Rod End Set  
(Ø12.7\*Ø14/M14\*1.5)

**HO1438**  
Rack End  
(14\*1.5/14\*1.5/235)



**HO1029**  
Outer Tie Rod End  
(Ø12.7\*Ø14/M14\*1.5)



**HO1525**  
Link Stabilizer  
L=324.5



**HO1924**  
Lower Ball Joint  
(Ø16)



**HO2046**  
Lower Control Arm

**HO2047**  
Lower Control Arm

**HO1924**  
Lower Ball Joint  
(Ø16)



**LEFT**

**RIGHT**

**HONDA**

**PRELUDE**

**FRONT**

**ALL MODEL**

*Year*

**1997-2001**

**HO1322**  
Outer Tie Rod End Set  
(Ø12.5\*Ø14/M14\*1.5)



**HO1024**  
Outer Tie Rod End  
(Ø12.5\*Ø14/M14\*1.5)



**HO1436**  
Rack End  
(14\*1.25/14\*1.5/141)



**HO1025**  
Outer Tie Rod End  
(Ø12.5\*Ø14/M14\*1.5)



**HO1554**  
Link Stabilizer  
L=104



**HO1612**  
Upper Ball Joint  
(--)



**HO1612**  
Upper Ball Joint  
(--)



**HO1923**  
Lower Ball Joint  
(--)



**HO1923**  
Lower Ball Joint  
(--)



**PRELUDE**

**REAR**

**HO1555**  
Link Stabilizer  
L=165



**LEFT**

**RIGHT**

**HYUNDAI**

**ACCENT**

**FRONT**

**1.3 / 1.5**

*Year*

**1994-2000**

**HY1310**

Outer Tie Rod End Set  
(Ø13.3\*Ø15/M14\*1.5)

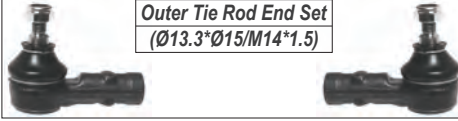

**HY1010**

Outer Tie Rod End  
(Ø13.3\*Ø15/M14\*1.5)



**HY1411**

Rack End  
(16\*1.5/14\*1.5/290)



**HY1010**

Outer Tie Rod End  
(Ø13.3\*Ø15/M14\*1.5)



**HY1412**

Rack End  
(16\*1.5/14\*1.5/295)



**HY1511 / HY1512**

Link Stabilizer  
L=60

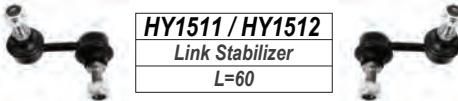

**HY1513**

Link Stabilizer  
L=133.5



**HY2112**

Lower Control Arm Bush



**HY1917**

Lower Ball Joint  
(Ø15)



**HY1917**

Lower Ball Joint  
(Ø15)



**HY2010**

Lower Control Arm



**HY2011**

Lower Control Arm

**HY2811**

Shock Mounting



**HY2811**

Shock Mounting



**HY2110 / HY2111**

Lower Control Arm Bush



**ACCENT**

**REAR**

**HY1514**

Link Stabilizer  
L=137



**LEFT**

**RIGHT**

**HYUNDAI**

ACCENT

FRONT

1.3 / 1.5 / 1.6

Year

2002-2006

**HY1010**  
Outer Tie Rod End  
(Ø13.3\*Ø15/M14\*1.5)

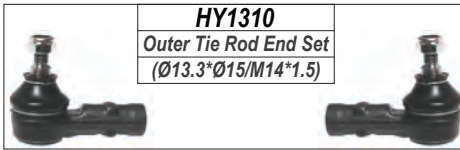

**HY1310**  
Outer Tie Rod End Set  
(Ø13.3\*Ø15/M14\*1.5)

**HY1413**  
Rack End  
(16\*1.5/14\*1.5/303)

**HY1010**  
Outer Tie Rod End  
(Ø13.3\*Ø15/M14\*1.5)



**HY1511 / HY1512**  
Link Stabilizer  
L=60



**HY1917**  
Lower Ball Joint  
(Ø15)



**HY2113**  
Lower Control Arm Bush



**HY2012**  
Lower Control Arm

**HY2013**  
Lower Control Arm

**HY1917**  
Lower Ball Joint  
(Ø15)



**HY2811**  
Shock Mounting



**HY2114**  
Lower Control Arm Bush



**HY2811**  
Shock Mounting



ACCENT

REAR

**HY1514**  
Link Stabilizer  
L=137



**HY2812**  
Shock Mounting



**HY2812**  
Shock Mounting



LEFT

RIGHT

**HYUNDAI**

ACCENT

FRONT

1.4 / 1.6

Year

2006-2011

**HY1011**  
Outer Tie Rod End  
(Ø13.3\*Ø15/M14\*1.5)

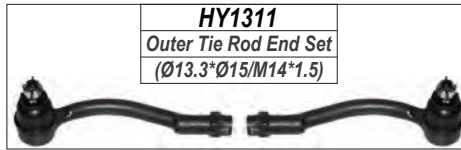

**HY1311**  
Outer Tie Rod End Set  
(Ø13.3\*Ø15/M14\*1.5)

**HY1414**  
Rack End  
(16\*1.5/14\*1.5/190)

**HY1012**  
Outer Tie Rod End  
(Ø13.3\*Ø15/M14\*1.5)



**HY1515 / HY1516**  
Link Stabilizer  
L=285



**HY2116**  
Lower Control Arm Bush



**HY1918**  
Lower Ball Joint  
(Ø15)



**HY1918**  
Lower Ball Joint  
(Ø15)



**HY2014**  
Lower Control Arm



**HY2015**  
Lower Control Arm



**HY2813**  
Shock Mounting



**HY2115**  
Lower Control Arm Bush



**HY2813**  
Shock Mounting



**HY2819**  
Shock Mounting



**HY2819**  
Shock Mounting



LEFT

RIGHT



**HYUNDAI**

ACCENT

FRONT

1.6

Year

2011-

**HY1021**  
Outer Tie Rod End  
(Ø13.2\*Ø15/M16\*1.5)



**HY1312**  
Outer Tie Rod End Set  
(Ø13.2\*Ø15/M16\*1.5)

**HY1415**  
Rack End  
(16\*1.5/16\*1.5/217)



**HY1022**  
Outer Tie Rod End  
(Ø13.2\*Ø15/M16\*1.5)



**KI1315**  
Outer Tie Rod End Set  
(Ø13.25\*Ø15/M14\*1.5)

**HY1437**  
Rack End  
(14\*1.5/14\*1.5/219)



**KI1015**  
Outer Tie Rod End  
(Ø13.25\*Ø15/M14\*1.5)



**KI1016**  
Outer Tie Rod End  
(Ø13.25\*Ø15/M14\*1.5)



**HY1517**  
Link Stabilizer  
L=282.5



**HY1917**  
Lower Ball Joint  
(Ø15)



**HY2118**  
Lower Control Arm Bush



**HY1917**  
Lower Ball Joint  
(Ø15)



**HY2016**  
Lower Control Arm



**HY2017**  
Lower Control Arm



**HY2117**  
Lower Control Arm Bush



LEFT

RIGHT

**HYUNDAI**

ATOS

FRONT

ALL MODELS

Year

1998-

**HY1313**  
Outer Tie Rod End Set  
(Ø13.3\*Ø15/M12\*1.25)

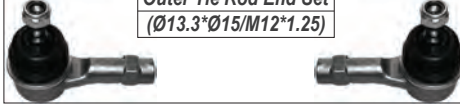

**HY1013**  
Outer Tie Rod End  
(Ø13.3\*Ø15/M12\*1.25)



**HY1416**  
Rack End  
(14\*1.5/12\*1.25/260)



**HY1013**  
Outer Tie Rod End  
(Ø13.2\*Ø15/M16\*1.5)



**HY1518**  
Link Stabilizer  
L=70



**HY1919**  
Lower Ball Joint  
(Ø13.4)



**HY1919**  
Lower Ball Joint  
(Ø13.4)



**HY2018**  
Lower Control Arm

**HY2019**  
Lower Control Arm



**HY2110 / HY2111**  
Lower Control Arm Bush

**HY2814**  
Shock Mounting



**HY2814**  
Shock Mounting



LEFT

RIGHT

**HYUNDAI**

**CRETA**

**FRONT**

**ALL MODELS**

*Year*

**2015-**



**HY1333**  
Outer Tie Rod End Set  
(Ø13.4\*Ø15.4/M14\*1.5)

**HY1049**  
Outer Tie Rod End  
(Ø13.4\*Ø15.4/M14\*1.5)

**HY1438**  
Rack End  
(16\*1.5/14\*1.5/353)

**HY1050**  
Outer Tie Rod End  
(Ø13.4\*Ø15.4/M14\*1.5)



**HY1566**  
Link Stabilizer  
(12\*1.5/L=281)



**HY2148**  
Lower Control Arm Bush

**HY1933**  
Lower Ball Joint  
(Ø15.1)



**HY1933**  
Lower Ball Joint  
(Ø15.1)

**HY2076**  
Lower Control Arm

**HY2077**  
Lower Control Arm

**HY2149**  
Lower Control Arm Bush

**HY2829**  
Shock Mounting



**HY2829**  
Shock Mounting



**LEFT**

**RIGHT**

**HYUNDAI**

ELANTRA

FRONT

J1

Year

1993-1995

**HY1010**  
Outer Tie Rod End  
(Ø13.3\*Ø15/M14\*1.5)

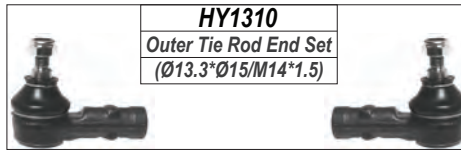

**HY1310**  
Outer Tie Rod End Set  
(Ø13.3\*Ø15/M14\*1.5)

**HY1411**  
Rack End  
(16\*1.5/14\*1.5/294)

**HY1010**  
Outer Tie Rod End  
(Ø13.3\*Ø15/M14\*1.5)



**HY1920**  
Lower Ball Joint  
(Ø15)



**HY2120**  
Lower Control Arm Bush



**HY1920**  
Lower Ball Joint  
(Ø15)



**HY2020**  
Lower Control Arm



**HY2021**  
Lower Control Arm



**HY2119**  
Lower Control Arm Bush



**HY2815**  
Shock Mounting



**HY2815**  
Shock Mounting



LEFT

RIGHT

**HYUNDAI**

**ELANTRA. TIBURON FRONT**

J2

Year

1996-2000

**HY1010**  
Outer Tie Rod End  
(Ø13.3\*Ø15/M14\*1.5)

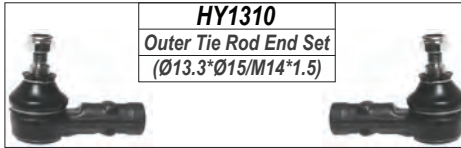

**HY1310**  
Outer Tie Rod End Set  
(Ø13.3\*Ø15/M14\*1.5)

**HY1417**  
Rack End  
(16\*1.5/14\*1.5/327)

**HY1010**  
Outer Tie Rod End  
(Ø13.3\*Ø15/M14\*1.5)



**HY1519**  
Link Stabilizer  
L=72



**HY1917**  
Lower Ball Joint  
(Ø15)



**HY2143**  
Lower Control Arm Bush



**HY1917**  
Lower Ball Joint  
(Ø15)



**HY2022**  
Lower Control Arm



**HY2023**  
Lower Control Arm

**HY2815**  
Shock Mounting



**HY2141 / HY2142**  
Lower Control Arm Bush



**HY2815**  
Shock Mounting



**ELANTRA. TIBURON REAR**

**HY1520**  
Link Stabilizer  
L=130



LEFT

RIGHT



**HYUNDAI**

ELANTRA

FRONT

J3 XD

Year

2000-2006

**HY1010**  
Outer Tie Rod End  
(Ø13.3\*Ø15/M14\*1.5)

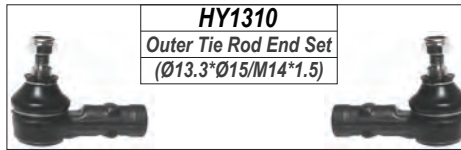

**HY1310**  
Outer Tie Rod End Set  
(Ø13.3\*Ø15/M14\*1.5)

**HY1417**  
Rack End  
(16\*1.5/14\*1.5/327)

**HY1010**  
Outer Tie Rod End  
(Ø13.3\*Ø15/M14\*1.5)



**HY1014**  
Outer Tie Rod End  
(Ø13.45\*Ø15/M14\*1.5)

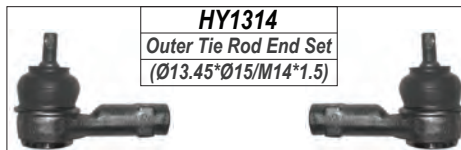

**HY1314**  
Outer Tie Rod End Set  
(Ø13.45\*Ø15/M14\*1.5)

**HY1418**  
Rack End  
(16\*1.5/14\*1.5/324)

**HY1014**  
Outer Tie Rod End  
(Ø13.45\*Ø15/M14\*1.5)



**HY1521**  
Link Stabilizer  
L=52



**HY1917**  
Lower Ball Joint  
(Ø15)



**HY2024**  
Lower Control Arm

**HY2025**  
Lower Control Arm

**HY1917**  
Lower Ball Joint  
(Ø15)



ELANTRA

REAR

**HY1520**  
Link Stabilizer  
L=130



LEFT

RIGHT

**HYUNDAI**

ELANTRA

FRONT

J4 HD

Year

2006-

**HY1010**  
Outer Tie Rod End  
(Ø13.3\*Ø15/M14\*1.5)

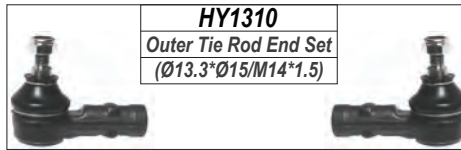

**HY1310**  
Outer Tie Rod End Set  
(Ø13.3\*Ø15/M14\*1.5)

**HY1417**  
Rack End  
(16\*1.5/14\*1.5/327)

**HY1010**  
Outer Tie Rod End  
(Ø13.3\*Ø15/M14\*1.5)

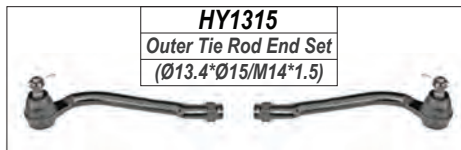

**HY1315**  
Outer Tie Rod End Set  
(Ø13.4\*Ø15/M14\*1.5)

**HY1023**  
Outer Tie Rod End  
(Ø13.4\*Ø15/M14\*1.5)



**HY1418**  
Rack End  
(16\*1.5/14\*1.5/163)



**HY1024**  
Outer Tie Rod End  
(Ø13.4\*Ø15/M14\*1.5)



**HY1521**  
Link Stabilizer  
L=52



**HY1917**  
Lower Ball Joint  
(Ø15)



**HY2024**  
Lower Control Arm

**HY2025**  
Lower Control Arm

**HY1917**  
Lower Ball Joint  
(Ø15)



**HY2813**  
Shock Mounting



**HY2813**  
Shock Mounting



LEFT

RIGHT

**HYUNDAI**

**ELANTRA**

**FRONT**

**J5 MD / UD**

**Year**

**2011-**

**HY1316**  
Outer Tie Rod End Set  
(Ø13.4\*Ø15/M16\*1.5)



**HY1025**  
Outer Tie Rod End  
(Ø13.4\*Ø15/M16\*1.5)



**HY1420**  
Rack End  
(16\*1.5/16\*1.5/226)



**HY1026**  
Outer Tie Rod End  
(Ø13.4\*Ø15/M16\*1.5)



**HY1517**  
Link Stabilizer  
L=282.5



**HY1917**  
Lower Ball Joint  
(Ø15)



**HY2121**  
Lower Control Arm Bush



**HY1917**  
Lower Ball Joint  
(Ø15)



**HY2026**  
Lower Control Arm



**HY2027**  
Lower Control Arm

**HY2117**  
Lower Control Arm Bush



**HY2072**  
Lower Control Arm  
Year 2014-



**HY2073**  
Lower Control Arm  
Year 2014-



**HY2816**  
Shock Mounting



**HY2816**  
Shock Mounting



**LEFT**

**RIGHT**

**HYUNDAI**

**ELANTRA**

**FRONT**

**AD**

**Year**

**2017-**

**HY1317**  
Outer Tie Rod End Set  
(Ø13.4\*Ø15.1/M16\*1.5)

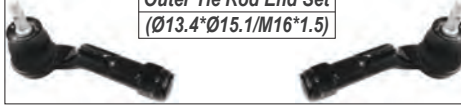

**HY1027**  
Outer Tie Rod End  
(Ø13.4\*Ø15.1/M16\*1.5)



**HY1421**  
Rack End  
(16\*1.5/16\*1.5/299.5)



**HY1028**  
Outer Tie Rod End  
(Ø13.4\*Ø15.1/M16\*1.5)



**HY1522**  
Link Stabilizer  
L=282.5



**HY1910**  
Lower Ball Joint  
(Ø15)



**HY2028**  
Lower Control Arm

**HY2029**  
Lower Control Arm

**HY1911**  
Lower Ball Joint  
(Ø15)



**LEFT**

**RIGHT**

**HYUNDAI**

GETZ

FRONT

ALL MODELS

Year

2003-

**HY1029**  
Outer Tie Rod End  
(Ø13.7\*Ø15/M14\*1.5)

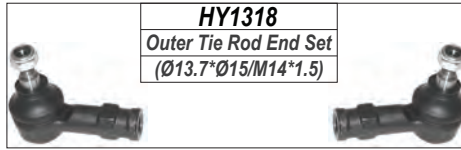

**HY1318**  
Outer Tie Rod End Set  
(Ø13.7\*Ø15/M14\*1.5)

**HY1417**  
Rack End  
(16\*1.5/14\*1.5/327)

**HY1029**  
Outer Tie Rod End  
(Ø13.7\*Ø15/M14\*1.5)



**HY1523 / HY1524**  
Link Stabilizer  
L=202



**HY1917**  
Lower Ball Joint  
(Ø15)



**HY2116**  
Lower Control Arm Bush



**HY1917**  
Lower Ball Joint  
(Ø15)



**HY2030**  
Lower Control Arm



**HY2031**  
Lower Control Arm



**HY2811**  
Shock Mounting



**HY2122**  
Lower Control Arm Bush



**HY2811**  
Shock Mounting



GETZ

REAR

**HY1514**  
Link Stabilizer  
L=137



LEFT

RIGHT



**HYUNDAI**

H1

FRONT

ALL MODELS

Year

2008-

**HY1030**  
Outer Tie Rod End  
(Ø13.75\*Ø16/M14\*1.5)

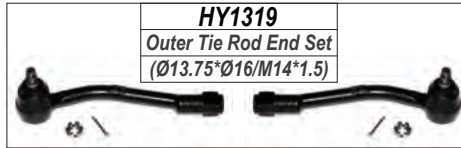

**HY1319**  
Outer Tie Rod End Set  
(Ø13.75\*Ø16/M14\*1.5)

**HY1422**  
Rack End  
(18\*1.5/14\*1.5/241)



**HY1031**  
Outer Tie Rod End  
(Ø13.75\*Ø16/M14\*1.5)



**HY1525 / HY1526**  
Link Stabilizer  
L=275



**HY1517**  
Link Stabilizer  
L=282.5



**HY1921**  
Lower Ball Joint  
(Ø20)



**HY2144**  
Lower Control Arm Bush



**HY1921**  
Lower Ball Joint  
(Ø20)



**HY2032**  
Lower Control Arm



**HY2033**  
Lower Control Arm



**HY2817**  
Shock Mounting



**HY2123**  
Lower Control Arm Bush



**HY2817**  
Shock Mounting



H1

REAR

**HY1527 / HY1528**  
Link Stabilizer  
L=85



LEFT

RIGHT

**HYUNDAI**

H-100

FRONT

ALL MODELS

Year

1997-

**HY1032**  
Outer Tie Rod End  
(Ø13.3\*Ø15/M14\*1.5)

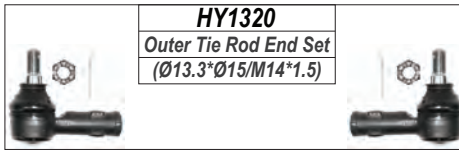

**HY1320**  
Outer Tie Rod End Set  
(Ø13.3\*Ø15/M14\*1.5)

**HY1423**  
Rack End  
(16\*1.5/14\*1.5/286)

**HY1032**  
Outer Tie Rod End  
(Ø13.3\*Ø15/M14\*1.5)



**HY1033**  
Outer Tie Rod End  
(Ø13.7\*Ø15.9/M16\*1.5)

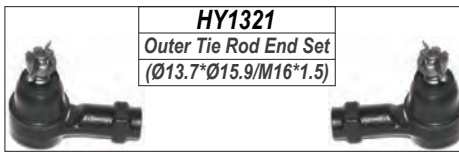

**HY1321**  
Outer Tie Rod End Set  
(Ø13.7\*Ø15.9/M16\*1.5)

**HY1424**  
Rack End  
(16\*1.5/16\*1.5/302)

**HY1033**  
Outer Tie Rod End  
(Ø13.7\*Ø15.9/M16\*1.5)



**HY1612**  
Upper Ball Joint  
(Ø17.6)



**HY1710**  
Upper Control Arm

**HY1711**  
Upper Control Arm

**HY1612**  
Upper Ball Joint  
(Ø17.6)



**HY2034**  
Lower Control Arm

**HY2035**  
Lower Control Arm

**HY1923**  
Lower Ball Joint  
(Ø19.5)



**HY2124**  
Lower Control Arm Bush



**HY1923**  
Lower Ball Joint  
(Ø19.5)



**HY2036**  
Lower Control Arm

**HY2037**  
Lower Control Arm

**HY2136**  
Lower Control Arm Bush



LEFT

RIGHT

**HYUNDAI**

**I10**

**FRONT**

**ALL MODELS**

*Year*

**2008-2014**

**HY1034**  
Outer Tie Rod End  
(Ø13.44\*Ø15/M12\*1.25)

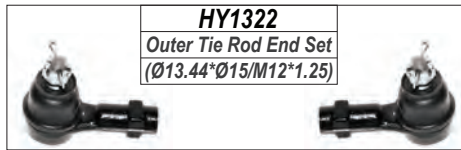

**HY1322**  
Outer Tie Rod End Set  
(Ø13.44\*Ø15/M12\*1.25)

**HY1425**  
Rack End  
(16\*1.5/12\*1.25/295)

**HY1034**  
Outer Tie Rod End  
(Ø13.44\*Ø15/M12\*1.25)

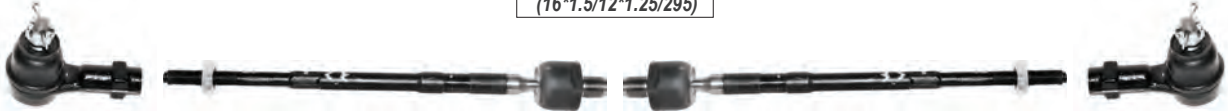

**HY1529 / HY1530**  
Link Stabilizer  
L=229.5



**HY1924**  
Lower Ball Joint  
(Ø16)



**HY2116**  
Lower Control Arm Bush



**HY1924**  
Lower Ball Joint  
(Ø16)



**HY2038**  
Lower Control Arm



**HY2039**  
Lower Control Arm



**HY2125**  
Lower Control Arm Bush



**HY2818**  
Shock Mounting



**HY2818**  
Shock Mounting



**LEFT**

**RIGHT**

**HYUNDAI**

**I10**

**FRONT**

**ALL MODELS**

**Year**

**2014-**

**HY1323**  
Outer Tie Rod End Set  
(Ø13.32\*Ø15.7/M14\*1.5)

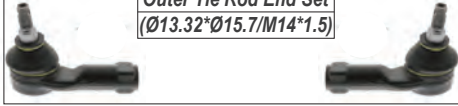

**HY1015**  
Outer Tie Rod End  
(Ø13.32\*Ø15.7/M14\*1.5)



**HY1410**  
Rack End  
(16\*1.5/14\*1.5/309)



**HY1016**  
Outer Tie Rod End  
(Ø13.32\*Ø15.7/M14\*1.5)



**HY1531 / HY1532**  
Link Stabilizer  
L=230



**HY2118**  
Lower Control Arm Bush



**HY1925**  
Lower Ball Joint  
(Ø18)



**HY1925**  
Lower Ball Joint  
(Ø18)



**HY2040**  
Lower Control Arm

**HY2041**  
Lower Control Arm

**HY2126**  
Lower Control Arm Bush

**HY2115**  
Lower Control Arm Bush

**HY1925**  
Lower Ball Joint  
(Ø18)



**HY1925**  
Lower Ball Joint  
(Ø18)



**HY2074**  
Lower Control Arm  
Grand I10

**HY2075**  
Lower Control Arm  
Grand I10

**HY2116**  
Lower Control Arm Bush

**LEFT**

**RIGHT**

**HYUNDAI**

I20

FRONT

ALL MODELS

Year

2008-

**HY1324**  
Outer Tie Rod End Set  
(Ø13.4\*Ø15/M16\*1.5)



**HY1017**  
Outer Tie Rod End  
(Ø13.4\*Ø15/M16\*1.5)



**HY1426**  
Rack End  
(16\*1.5/16\*1.5/224)



**HY1018**  
Outer Tie Rod End  
(Ø13.4\*Ø15/M16\*1.5)



**HY1533 / HY1534**  
Link Stabilizer  
L=216



**HY2115**  
Lower Control Arm Bush

Lower Control Arm Bush



**HY2116**  
Lower Control Arm Bush

Lower Control Arm Bush



**HY1917**  
Lower Ball Joint  
(Ø15)



**HY1917**  
Lower Ball Joint  
(Ø15)



**HY2042**  
Lower Control Arm

**HY2043**  
Lower Control Arm



**HY2819**  
Shock Mounting



**HY2819**  
Shock Mounting



LEFT

RIGHT



**HYUNDAI**

I20

FRONT

ALL MODELS

Year

2015-

**HY1019**  
Outer Tie Rod End  
(Ø13.4\*Ø15/M16\*1.5)

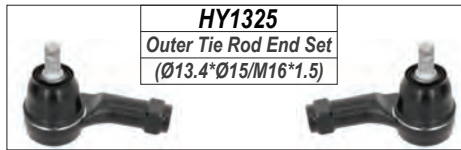

**HY1325**  
Outer Tie Rod End Set  
(Ø13.4\*Ø15/M16\*1.5)

**HY1427**  
Rack End  
(16\*1.5/16\*1.5/224)

**HY1020**  
Outer Tie Rod End  
(Ø13.4\*Ø15/M16\*1.5)



**HY1535**  
Link Stabilizer  
L=282.5



**HY2127**  
Lower Control Arm Bush



**HY1912**  
Lower Ball Joint  
(Ø15)



**HY1912**  
Lower Ball Joint  
(Ø15)



**HY2044**  
Lower Control Arm



**HY2045**  
Lower Control Arm

**HY2128**  
Lower Control Arm Bush



LEFT

RIGHT

**HYUNDAI**

I30

FRONT

FD

Year

2009-2011

**HY1023**  
Outer Tie Rod End  
(Ø13.4\*Ø15/M14\*1.5)

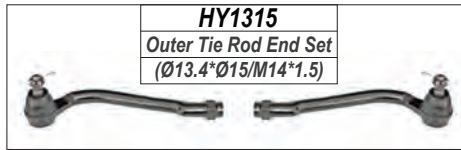

**HY1315**  
Outer Tie Rod End Set  
(Ø13.4\*Ø15/M14\*1.5)

**HY1419**  
Rack End  
(16\*1.5/14\*1.5/163)



**HY1024**  
Outer Tie Rod End  
(Ø13.4\*Ø15/M14\*1.5)



**HY1536**  
Link Stabilizer  
L=243.5



**HY2130**  
Lower Control Arm Bush



**HY1926**  
Lower Ball Joint  
(Ø15)



**HY1926**  
Lower Ball Joint  
(Ø15)



**HY2046**  
Lower Control Arm

**HY2047**  
Lower Control Arm

**HY2813**  
Shock Mounting



**HY2813**  
Shock Mounting



**HY2129**  
Lower Control Arm Bush



I30

REAR

**HY2821**  
Shock Mounting



**HY1537**  
Link Stabilizer  
L=170



**HY2821**  
Shock Mounting

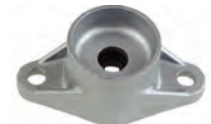

**HY1538**  
Link Stabilizer  
L=195



LEFT

RIGHT

**HYUNDAI**

I30

FRONT

GD

Year

2011-

**HY1025**  
Outer Tie Rod End  
(Ø13.4\*Ø15.1/M16\*1.5)

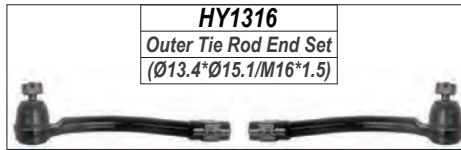

**HY1316**  
Outer Tie Rod End Set  
(Ø13.4\*Ø15.1/M16\*1.5)

**HY1428**  
Rack End  
(16\*1.5/16\*1.5/218)



**HY1026**  
Outer Tie Rod End  
(Ø13.4\*Ø15.1/M16\*1.5)



**HY1536**  
Link Stabilizer  
L=243.5



**HY2121**  
Lower Control Arm Bush

**HY1927**  
Lower Ball Joint  
(Ø18)



**HY2048**  
Lower Control Arm



**HY2049**  
Lower Control Arm



**HY1927**  
Lower Ball Joint  
(Ø18)



**HY2820**  
Shock Mounting



**HY2131**  
Lower Control Arm Bush



**HY2820**  
Shock Mounting



I30

REAR

**HY1537**  
Link Stabilizer  
L=170



**HY1538**  
Link Stabilizer  
L=195

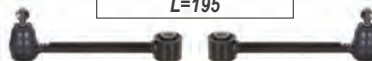

LEFT

RIGHT

**HYUNDAI**

IX35

FRONT

LM

Year

2010-

**HY1326**  
Outer Tie Rod End Set  
(Ø13.4\*Ø15/M16\*1.5)



**HY1035**  
Outer Tie Rod End  
(Ø13.4\*Ø15/M16\*1.5)



**HY1429**  
Rack End  
(16\*1.5/16\*1.5/184)



**HY1036**  
Outer Tie Rod End  
(Ø13.4\*Ø15/M16\*1.5)



**HY1539**  
Link Stabilizer  
L=267



**HY2132**  
Lower Control Arm Bush



**HY1928**  
Lower Ball Joint  
(Ø18)

**HY1928**  
Lower Ball Joint  
(Ø18)

**HY2050**  
Lower Control Arm

**HY2051**  
Lower Control Arm



**HY2822**  
Shock Mounting



**HY2133**  
Lower Control Arm Bush



**HY2822**  
Shock Mounting



IX35

REAR

**HY1540**  
Link Stabilizer  
L=95



**HY2823**  
Shock Mounting



**HY1541**  
Link Stabilizer  
L=140



**HY2823**  
Shock Mounting



LEFT

RIGHT

**HYUNDAI**

**MATRIX**

**FRONT**

**ALL MODELS**

*Year*

**2001-2007**

**HY1010**  
Outer Tie Rod End  
(Ø13.3\*Ø15/M14\*1.5)

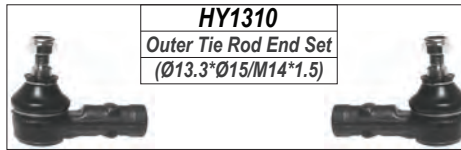

**HY1310**  
Outer Tie Rod End Set  
(Ø13.3\*Ø15/M14\*1.5)

**HY1418**  
Rack End  
(16\*1.5/14\*1.5/324)

**HY1010**  
Outer Tie Rod End  
(Ø13.3\*Ø15/M14\*1.5)



**HY1511 / HY1512**  
Link Stabilizer  
L=59



**HY2113**  
Lower Control Arm Bush



**HY1917**  
Lower Ball Joint  
(Ø15)



**HY2052**  
Lower Control Arm



**HY2053**  
Lower Control Arm

**HY1917**  
Lower Ball Joint  
(Ø15)



**HY2147**  
Lower Control Arm Bush



**HY2815**  
Shock Mounting



**HY2815**  
Shock Mounting



**MATRIX**

**REAR**

**HY1520**  
Link Stabilizer  
L=130



**LEFT**

**RIGHT**



**HYUNDAI**

SANTA-FE

FRONT

SM

Year

2001-2006

**HY1029**  
Outer Tie Rod End  
(Ø13.7\*Ø15/M14\*1.5)

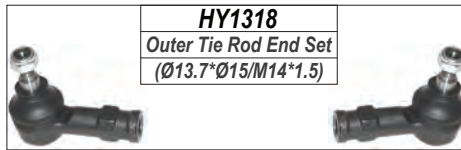

**HY1318**  
Outer Tie Rod End Set  
(Ø13.7\*Ø15/M14\*1.5)

**HY1430**  
Rack End  
(16\*1.5/14\*1.5/326)

**HY1029**  
Outer Tie Rod End  
(Ø13.7\*Ø15/M14\*1.5)



**HY1542 / HY1543**  
Link Stabilizer  
L=263



**HY2145**  
Lower Control Arm Bush

Lower Control Arm Bush



**HY2146**  
Lower Control Arm Bush

Lower Control Arm Bush



**HY1929**  
Lower Ball Joint  
(Ø20)



**HY1929**  
Lower Ball Joint  
(Ø20)



**HY2054**  
Lower Control Arm



**HY2055**  
Lower Control Arm



**HY2824**  
Shock Mounting



**HY2824**  
Shock Mounting



SANTA-FE

REAR

**HY1544 / HY1545**  
Link Stabilizer  
L=117.5



LEFT

RIGHT

**HYUNDAI**

SANTA-FE

FRONT

CM

Year

2006-

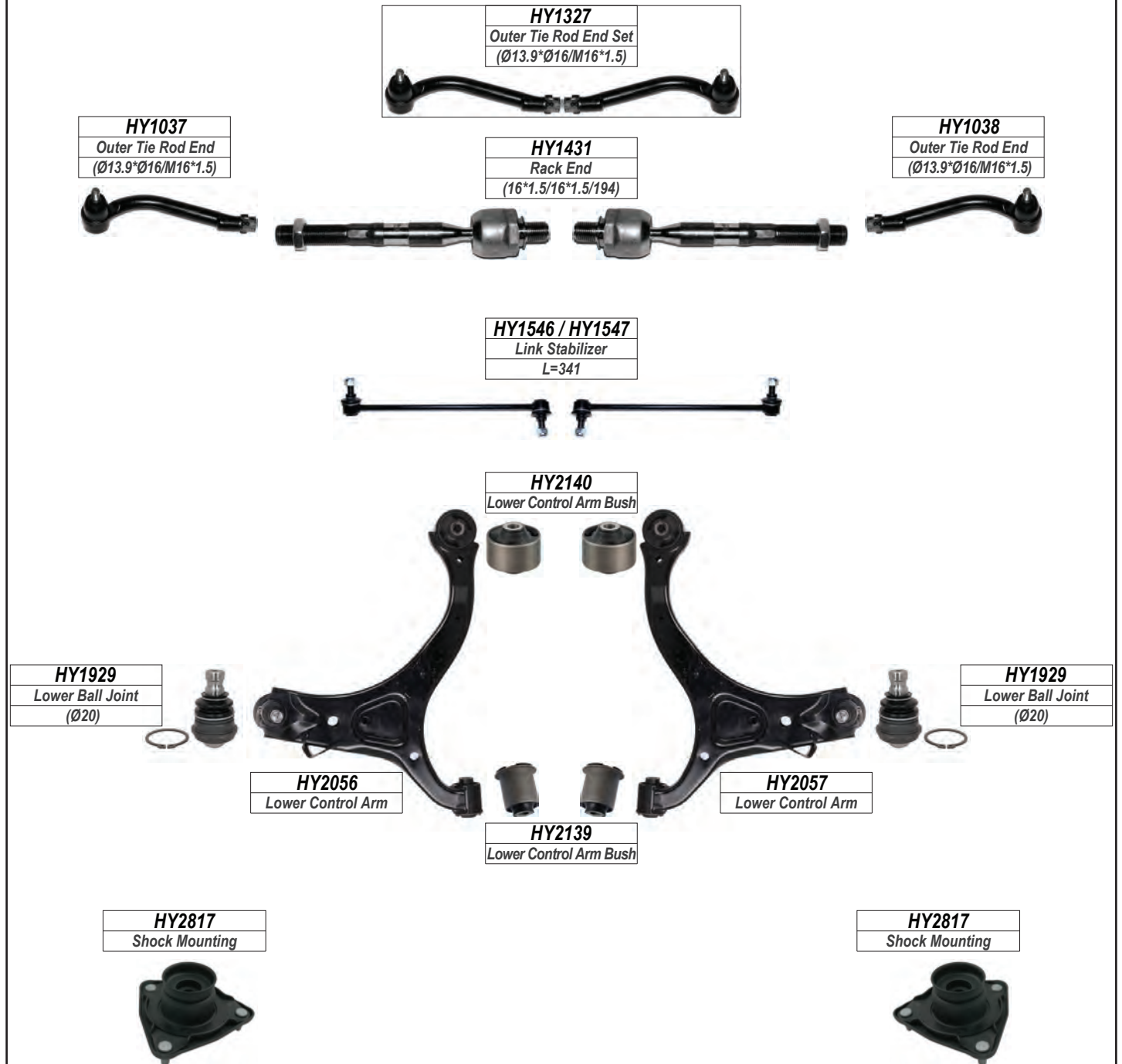

SANTA-FE

REAR



LEFT

RIGHT

**HYUNDAI**

SANTA-FE

FRONT

DM

Year

2012-

**HY1039**  
Outer Tie Rod End  
(Ø13.4\*Ø16/M16\*1.5)



**HY1328**  
Outer Tie Rod End Set  
(Ø13.4\*Ø16/M16\*1.5)

**HY1432**  
Rack End  
(16\*1.5/16\*1.5/192)



**HY1040**  
Outer Tie Rod End  
(Ø13.4\*Ø16/M16\*1.5)



**HY1549**  
Link Stabilizer  
L=328



**HY1927**  
Lower Ball Joint  
(Ø18)



**HY2058**  
Lower Control Arm



**HY2059**  
Lower Control Arm

**HY1927**  
Lower Ball Joint  
(Ø18)



**SANTA-FE**

REAR

**HY1550 / HY1551**  
Link Stabilizer  
L=88



**KI1538**  
Link Stabilizer  
L=90



**HY2610**  
Lateral Link



LEFT

RIGHT

**HYUNDAI**

**SONATA**

**FRONT**

*Year*

**1994-1998**

**II**

**HY1029**  
Outer Tie Rod End  
(Ø13.7\*Ø15/M14\*1.5)

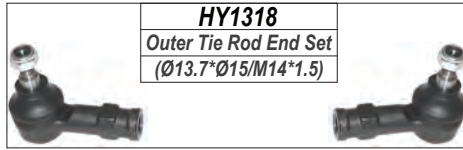

**HY1318**  
Outer Tie Rod End Set  
(Ø13.7\*Ø15/M14\*1.5)

**HY1417**  
Rack End  
(16\*1.5/14\*1.5/327)

**HY1029**  
Outer Tie Rod End  
(Ø13.7\*Ø15/M14\*1.5)



**HY1913**  
Lower Ball Joint  
(Ø15.1)



**HY1913**  
Lower Ball Joint  
(Ø15.1)



**HY2825**  
Shock Mounting



**HY2825**  
Shock Mounting



**LEFT**

**RIGHT**

**HYUNDAI**

**SONATA**

**FRONT**

Year

1998-2002

III

**HY1329**  
Outer Tie Rod End Set  
(Ø13.45\*Ø15/M14\*1.5)



**HY1041**  
Outer Tie Rod End  
(Ø13.45\*Ø15/M14\*1.5)



**HY1433**  
Rack End  
(16\*1.5/14\*1.5/166)



**HY1042**  
Outer Tie Rod End  
(Ø13.45\*Ø15/M14\*1.5)



**HY1552**  
Link Stabilizer  
L=102.5



**HY1613**  
Upper Ball Joint  
(Ø13.4)



**HY1613**  
Upper Ball Joint  
(Ø13.4)



**HY2826**  
Shock Mounting



**HY2826**  
Shock Mounting



**SONATA**

**REAR**

**HY1553**  
Link Stabilizer  
L=108



**LEFT**

**RIGHT**



**HYUNDAI**

SONATA

FRONT

IV

Year

2002-2006

**HY1329**  
Outer Tie Rod End Set  
(Ø13.45\*Ø15/M14\*1.5)

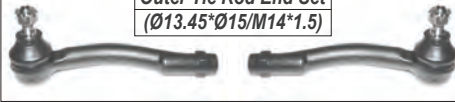

**HY1041**  
Outer Tie Rod End  
(Ø13.45\*Ø15/M14\*1.5)



**HY1433**  
Rack End  
(16\*1.5/14\*1.5/166)



**HY1042**  
Outer Tie Rod End  
(Ø13.45\*Ø15/M14\*1.5)



**HY1552**  
Link Stabilizer  
L=102.5

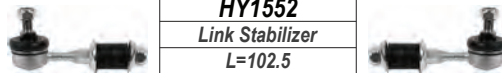

**HY1613**  
Upper Ball Joint  
(Ø13.4)



**HY1613**  
Upper Ball Joint  
(Ø13.4)



**HY1712**  
Upper Control Arm

**HY1713**  
Upper Control Arm

**HY1930**  
Lower Ball Joint  
(Ø18.1)



**HY2135**  
Lower Control Arm Bush



**HY1930**  
Lower Ball Joint  
(Ø18.1)



**HY2060**  
Lower Control Arm



**HY2061**  
Lower Control Arm



**HY2826**  
Shock Mounting



**HY2826**  
Shock Mounting



**HY2134**  
Lower Control Arm Bush



SONATA

REAR

**HY1553**  
Link Stabilizer  
L=180



**HY1554**  
Link Stabilizer  
L=193.5



LEFT

RIGHT

**HYUNDAI**

**SONATA**

**FRONT**

Year

2006-2010

V

**HY1330**  
Outer Tie Rod End Set  
(Ø13.5\*Ø15/M16\*1.5)



**HY1043**  
Outer Tie Rod End  
(Ø13.5\*Ø15/M16\*1.5)



**HY1434**  
Rack End  
(16\*1.5/16\*1.5/180)



**HY1044**  
Outer Tie Rod End  
(Ø13.5\*Ø15/M16\*1.5)



**HY1555**  
Link Stabilizer  
L=150

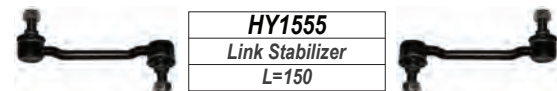

**HY1614**  
Upper Ball Joint  
(Ø13.5)



**HY1714**  
Upper Control Arm

**HY1715**  
Upper Control Arm

**HY1614**  
Upper Ball Joint  
(Ø13.5)



**HY2137**  
Lower Control Arm Bush



**HY1931**  
Lower Ball Joint  
(Ø15.1)



**HY1931**  
Lower Ball Joint  
(Ø15.1)



**HY2810**  
Stabilizer Bush



**HY2062**  
Lower Control Arm

**HY2063**  
Lower Control Arm

**HY2810**  
Stabilizer Bush



**HY2827**  
Shock Mounting



**HY2138**  
Lower Control Arm Bush



**HY2827**  
Shock Mounting



**SONATA**

**REAR**

**HY2828**  
Shock Mounting



**HY1556**  
Link Stabilizer  
L=80



**HY2828**  
Shock Mounting



LEFT

RIGHT

**HYUNDAI**

**SONATA**

**FRONT**

Year

2010-2014

VI

**HY1035**  
Outer Tie Rod End  
(Ø13.4\*Ø15/M16\*1.5)

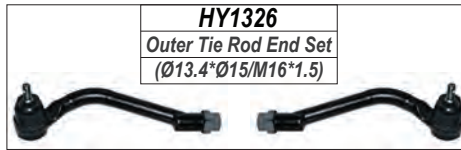

**HY1326**  
Outer Tie Rod End Set  
(Ø13.4\*Ø15/M16\*1.5)

**HY1432**  
Rack End  
(16\*1.5/16\*1.5/195)



**HY1036**  
Outer Tie Rod End  
(Ø13.4\*Ø15/M16\*1.5)



**HY1557 / HY1558**  
Link Stabilizer  
L=351.5



**HY1927**  
Lower Ball Joint  
(Ø18)



**HY2064**  
Lower Control Arm



**HY2065**  
Lower Control Arm

**HY1927**  
Lower Ball Joint  
(Ø18)



**CH2811**  
Shock Mounting



**CH2811**  
Shock Mounting



**SONATA**

**REAR**

**HY1559**  
Link Stabilizer  
L=195



**LEFT**

**RIGHT**

**HYUNDAI**

**TIBURON**

**FRONT**

**ALL MODELS**

*Year*

**2000-**

**HY1010**  
Outer Tie Rod End  
(Ø13.3\*Ø15/M14\*1.5)

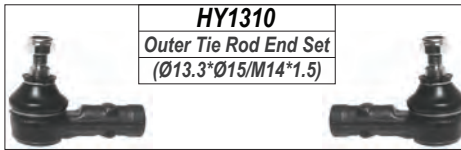

**HY1310**  
Outer Tie Rod End Set  
(Ø13.3\*Ø15/M14\*1.5)

**HY1417**  
Rack End  
(16\*1.5/14\*1.5/327)

**HY1010**  
Outer Tie Rod End  
(Ø13.3\*Ø15/M14\*1.5)



**HY1519**  
Link Stabilizer  
L=72



**HY1610**  
Upper Ball Joint  
(Ø15)



**HY1714**  
Upper Control Arm



**HY1715**  
Upper Control Arm

**HY1610**  
Upper Ball Joint  
(Ø15)



**HY1917**  
Lower Ball Joint  
(Ø15)



**HY1917**  
Lower Ball Joint  
(Ø15)



**HY2815**  
Shock Mounting



**HY2815**  
Shock Mounting



**LEFT**

**RIGHT**

**HYUNDAI**

**TERRECAN**

**FRONT**

**ALL MODELS**

*Year*

**2003-2008**

**HY2310**  
Drag Link

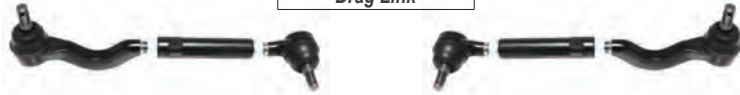

**HY1560 / HY1561**  
Link Stabilizer  
L=72



**HY1611**  
Upper Ball Joint  
(Ø16)



**HY1716**  
Upper Control Arm



**HY1717**  
Upper Control Arm



**HY1611**  
Upper Ball Joint  
(Ø16)

**HY1914**  
Lower Ball Joint  
(Ø19.5)



**HY2070**  
Lower Control Arm



**HY2071**  
Lower Control Arm



**HY1914**  
Lower Ball Joint  
(Ø19.5)

**LEFT**

**RIGHT**



**HYUNDAI**

**TUCSON**

**FRONT**

**ALL MODELS**

*Year*

**2004-2010**

**HY1045**  
Outer Tie Rod End  
(Ø13.45\*Ø15/M16\*1.5)



**HY1331**  
Outer Tie Rod End Set  
(Ø13.45\*Ø15/M16\*1.5)

**HY1435**  
Rack End  
(16\*1.5/16\*1.5/241)



**HY1046**  
Outer Tie Rod End  
(Ø13.45\*Ø15/M16\*1.5)



**HY1510**  
Link Stabilizer  
L=238



**HY2115**  
Lower Control Arm Bush

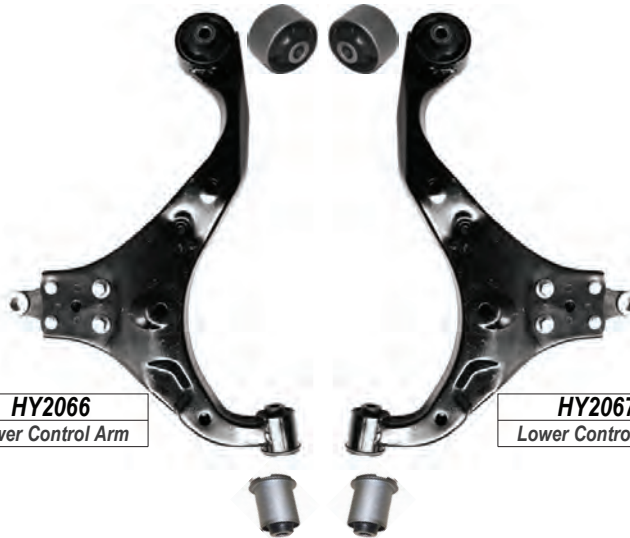

**HY2130**  
Lower Control Arm Bush

**HY1932**  
Lower Ball Joint  
(Ø14.55)



**HY1932**  
Lower Ball Joint  
(Ø14.55)



**HY2066**  
Lower Control Arm

**HY2067**  
Lower Control Arm

**HY2822**  
Shock Mounting



**HY2822**  
Shock Mounting



**TUCSON**

**REAR**

**HY1563**  
Link Stabilizer  
L=219



**LEFT**

**RIGHT**

**HYUNDAI**

**TUCSON**

**FRONT**

**ALL MODELS**

*Year*

**2015-**

**HY1047**  
Outer Tie Rod End  
(Ø13.85\*Ø16.1/M14\*1.5)



**HY1332**  
Outer Tie Rod End Set  
(Ø13.85\*Ø16.1/M14\*1.5)

**HY1436**  
Rack End  
(16\*1.5/14\*1.5/242.5)



**HY1048**  
Outer Tie Rod End  
(Ø13.85\*Ø16.1/M14\*1.5)



**HY1535**  
Link Stabilizer  
L=282.5



**HY1915**  
Lower Ball Joint  
(Ø18)



**HY2068**  
Lower Control Arm



**HY2069**  
Lower Control Arm



**HY1916**  
Lower Ball Joint  
(Ø18)



**TUCSON**

**REAR**

**HY1564**  
Link Stabilizer  
L=140



**LEFT**

**RIGHT**

**HYUNDAI**

**VELOSTER**

**FRONT**

**ALL MODELS**

*Year*

**2013-**

**HY1025**  
Outer Tie Rod End  
(Ø13.4\*Ø15/M14\*1.5)

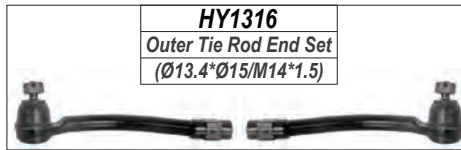

**HY1316**  
Outer Tie Rod End Set  
(Ø13.4\*Ø15/M14\*1.5)

**HY1420**  
Rack End  
(16\*1.5/16\*1.5/226)



**HY1026**  
Outer Tie Rod End  
(Ø13.4\*Ø15/M14\*1.5)



**HY1517**  
Link Stabilizer  
L=282.5



**HY1917**  
Lower Ball Joint  
(Ø15)



**HY2121**  
Lower Control Arm Bush



**HY1917**  
Lower Ball Joint  
(Ø15)



**HY2026**  
Lower Control Arm



**HY2027**  
Lower Control Arm

**HY2117**  
Lower Control Arm Bush



**LEFT**

**RIGHT**

**ISUZU**

**KB**

**FRONT**

**ALL MODEL**

*Year*

**1981-1989**

**IS2210**  
Center Rod

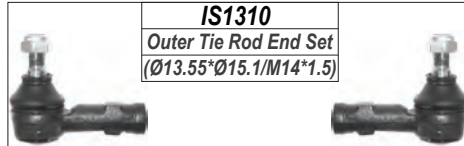

**IS1310**  
Outer Tie Rod End Set  
(Ø13.55\*Ø15.1/M14\*1.5)

**IS1011**  
Outer Tie Rod End  
(Ø13.55\*Ø15.1/M14\*1.5)



**IS1410**  
Rack End  
(14\*1.5/14\*1.5/265)



**IS1011**  
Outer Tie Rod End  
(Ø13.55\*Ø15.1/M14\*1.5)



**IS1411**  
Rack End  
(14\*1.5/14\*1.5/244)



**IS1610**  
Upper Ball Joint  
(Ø17.6)



**IS1610**  
Upper Ball Joint  
(Ø17.6)



**IS1910**  
Lower Ball Joint  
(Ø17.57)



**IS1910**  
Lower Ball Joint  
(Ø17.57)



**IS1911**  
Lower Ball Joint  
(Ø19.6)



**IS1911**  
Lower Ball Joint  
(Ø19.6)



**IS2410**  
Idler Arm



**LEFT**

**RIGHT**

**ISUZU**

**KB**

**FRONT**

**2WD**

*Year*

**1989-2004**

**IS2211**  
Center Rod



**IS2212 / IS2213**  
Center Rod



**IS1312**  
Inner Tie Rod End Set  
(Ø16.2\*Ø18/M14\*1.5)

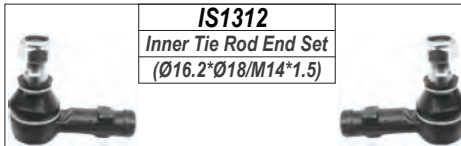

**IS1012**  
Outer Tie Rod End  
(Ø16.2\*Ø18/M14\*1.5)



**IS1110**  
Inner Tie Rod End  
(Ø16.2\*Ø18/M14\*1.5)



**IS1110**  
Inner Tie Rod End  
(Ø16.2\*Ø18/M14\*1.5)



**IS1012**  
Outer Tie Rod End  
(Ø16.2\*Ø18/M14\*1.5)



**IS1210**  
Tie Rod End Assembly



**IS1210**  
Tie Rod End Assembly



**FT1510 / FT1511**  
Link Stabilizer  
L=155

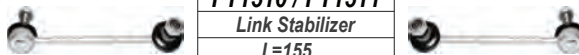

**IS1610**  
Upper Ball Joint  
(Ø17.6)



**IS1610**  
Upper Ball Joint  
(Ø17.6)



**IS1710**  
Upper Control Arm  
1989-1998



**IS1711**  
Upper Control Arm  
1989-1998



**IS1712**  
Upper Control Arm  
1998-2004



**IS1713**  
Upper Control Arm  
1998-2004



**LEFT**

**RIGHT**



**ISUZU**

**KB**

**FRONT**

**2WD**

*Year*

**1989-2004**



**IS1714**  
Upper Control Arm  
320 Only

**IS1715**  
Upper Control Arm  
320 Only

**IS1912**  
Lower Ball Joint  
(Ø20.5)



**IS2010**  
Lower Control Arm



**IS2011**  
Lower Control Arm



**IS1912**  
Lower Ball Joint  
(Ø20.5)



**FT2010**  
Lower Control Arm  
1997-1999 (320 Only)



**FT2011**  
Lower Control Arm  
1997-1999 (320 Only)

**FT1911**  
Lower Ball Joint  
(Ø20.6)(320 Only)



**IS2012**  
Lower Control Arm  
2000-2004 (320 Only)



**IS2013**  
Lower Control Arm  
2000-2004 (320 Only)

**FT1911**  
Lower Ball Joint  
(Ø20.6)(320 Only)



**IS2410**  
Idler Arm



**LEFT**

**RIGHT**

**ISUZU**

KB

FRONT

4WD

Year

1989-2004

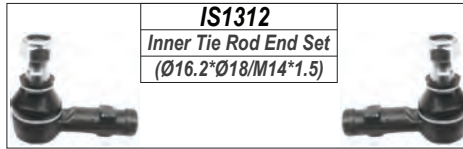

**IS1312**  
Inner Tie Rod End Set  
(Ø16.2\*Ø18/M14\*1.5)

**IS1012**  
Outer Tie Rod End  
(Ø16.2\*Ø18/M14\*1.5)



**IS1110**  
Inner Tie Rod End  
(Ø16.2\*Ø18/M14\*1.5)



**IS1110**  
Inner Tie Rod End  
(Ø16.2\*Ø18/M14\*1.5)



**IS1012**  
Outer Tie Rod End  
(Ø16.2\*Ø18/M14\*1.5)



**IS1210**  
Tie Rod End Assembly

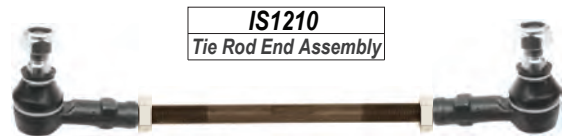

**IS1210**  
Tie Rod End Assembly



**FT1510 / FT1511**  
Link Stabilizer  
L=155

**IS1610**  
Upper Ball Joint  
(Ø17.6)



**IS1610**  
Upper Ball Joint  
(Ø17.6)

**IS1716**  
Upper Control Arm  
1989-1997

**IS1717**  
Upper Control Arm  
1989-1997



**IS1714**  
Upper Control Arm  
1998-2004

**IS1715**  
Upper Control Arm  
1998-2004

**LEFT**

**RIGHT**

**ISUZU**

**KB**

**FRONT**

**4WD**

*Year*

**1989-2004**

**FT1911**

Lower Ball Joint  
(Ø20.6)



**FT2010**

Lower Control Arm  
1989-1999



**FT2011**

Lower Control Arm  
1989-1999



**FT1911**

Lower Ball Joint  
(Ø20.6)



**IS2012**

Lower Control Arm  
2000-2004



**IS2013**

Lower Control Arm  
2000-2004

**IS2410**

Idler Arm



**LEFT**

**RIGHT**

**ISUZU**

**KB/D-MAX**

**FRONT**

**ALL MODEL**

*Year*

**2004-**

**FT1010**  
Outer Tie Rod End  
(Ø16.1\*Ø18/M14\*1.5)

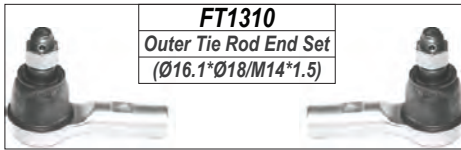

**FT1310**  
Outer Tie Rod End Set  
(Ø16.1\*Ø18/M14\*1.5)

**IS1412**  
Rack End  
(14\*1.5/14\*1.5/303)



**FT1010**  
Outer Tie Rod End  
(Ø16.1\*Ø18/M14\*1.5)



**IS1413**  
Rack End  
(14\*1.5/14\*1.5/290)



**IS1414**  
Rack End  
(18\*1.5/14\*1.5/294)



**IS1510**  
Link Stabilizer  
L=114.5



**FT1510 / FT1511**  
Link Stabilizer  
L=155



**FT1610**  
Upper Ball Joint  
(Ø17.56)



**FT1610**  
Upper Ball Joint  
(Ø17.56)

**FT1712**  
Upper Control Arm  
HI-RIDER

**FT1713**  
Upper Control Arm  
HI-RIDER

**FT1611**  
Upper Ball Joint  
(Ø17.6)



**FT1611**  
Upper Ball Joint  
(Ø17.6)

**FT1714**  
Upper Control Arm

**FT1715**  
Upper Control Arm

**LEFT**

**RIGHT**

**ISUZU**

**KB/D-MAX**

**FRONT**

**ALL MODEL**

*Year*

**2004-**



**IS1718**  
Upper Control Arm



**IS1719**  
Upper Control Arm



**IS2014**  
Lower Control Arm  
STD-BODY



**IS2015**  
Lower Control Arm  
STD-BODY



**FT1911**  
Lower Ball Joint  
(Ø20.6)



**FT1911**  
Lower Ball Joint  
(Ø20.6)



**IS2016**  
Lower Control Arm  
HI-RIDER

**IS2017**  
Lower Control Arm  
HI-RIDER

**LEFT**

**RIGHT**



**ISUZU**

RELAY

FRONT

ALL MODEL

Year

1983-1995

**IS1313**

Outer Tie Rod End Set  
(Ø13.3\*Ø15.4/M16\*1.5)

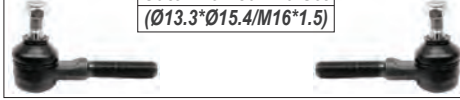

**IS1314**

Inner Tie Rod End Set  
(Ø13.3\*Ø15.4/M16\*1.5)

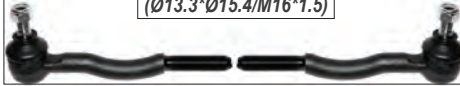

**IS1010**

Outer Tie Rod End  
(Ø13.3\*Ø15.4/M16\*1.5)



**IS1111**

Inner Tie Rod End  
(Ø13.3\*Ø15.4/M16\*1.5)



**IS1010**

Outer Tie Rod End  
(Ø13.3\*Ø15.4/M16\*1.5)



**IS1610**

Upper Ball Joint  
(Ø17.6)



**IS1610**

Upper Ball Joint  
(Ø17.6)



**LEFT**

**RIGHT**

**IVECO**

**DAILY**

**FRONT**

**II**

*Year*

**1999-2006**

**IV1010(P/S)**  
Outer Tie Rod End  
(Ø21.6\*Ø24.6/M20\*1.5)

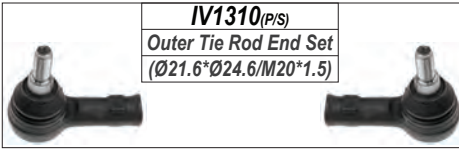

**IV1310(P/S)**  
Outer Tie Rod End Set  
(Ø21.6\*Ø24.6/M20\*1.5)

**IV1010(P/S)**  
Outer Tie Rod End  
(Ø21.6\*Ø24.6/M20\*1.5)



**IV1011(M/S)**  
Outer Tie Rod End  
(Ø18.1\*Ø20.6/M16\*1.5)

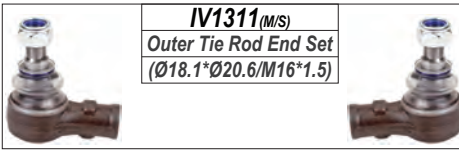

**IV1311(M/S)**  
Outer Tie Rod End Set  
(Ø18.1\*Ø20.6/M16\*1.5)

**IV1011(M/S)**  
Outer Tie Rod End  
(Ø18.1\*Ø20.6/M16\*1.5)



**IV1410**  
Rack End  
(16\*1.5/16\*1.5/330)



**IV1610**  
Upper Ball Joint  
(Ø21.1)



**IV1610**  
Upper Ball Joint  
(Ø21.1)



**IV1710**  
Upper Control Arm

**IV1711**  
Upper Control Arm

**IV1911**  
Upper/Lower Ball Joint  
(Ø21.35)



**IV1911**  
Upper/Lower Ball Joint  
(Ø21.35)



**IV1910**  
Lower Ball Joint  
(Ø17.9)



**IV2110**  
Lower Control Arm Bush

**IV1910**  
Lower Ball Joint  
(Ø17.9)



**IV2010**  
Lower Control Arm

**IV2011**  
Lower Control Arm

**LEFT**

**RIGHT**

**JAGUAR**

**S-TYPE**

**FRONT**

**ALL MODEL**

*Year*

**1999-2008**

**JA1010**  
Outer Tie Rod End  
(Ø11.7\*Ø25/M14\*1.5)



**JA1012**  
Outer Tie Rod End  
(Ø13.5\*Ø24/M14\*1.5)



**JA1010**  
Outer Tie Rod End  
(Ø11.7\*Ø25/M14\*1.5)



**JA1013**  
Outer Tie Rod End  
(Ø13.5\*Ø24/M14\*1.5)



**JA1410**  
Rack End  
(16\*1.5/14\*1.5/209)

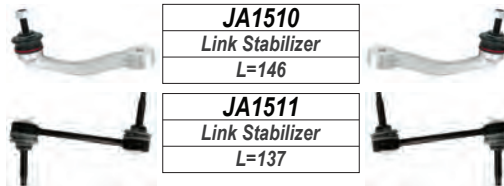

**JA1910**  
Lower Ball Joint



**JA2010**  
Lower Control Arm



**JA2011**  
Lower Control Arm



**JA1910**  
Lower Ball Joint

**JA2810**  
Stabilizer Bar Bush



**JA2810**  
Stabilizer Bar Bush



**S-TYPE**

**REAR**

**JA1512**  
Link Stabilizer  
L=522



**JA1513 / JA1514**  
Link Stabilizer  
L=223



**LEFT**

**RIGHT**

**JAGUAR**

X-TYPE

FRONT

ALL MODEL

Year

2001-2009

**FO1018**  
Outer Tie Rod End  
(Ø12.6\*Ø16.1/M16\*1.5)

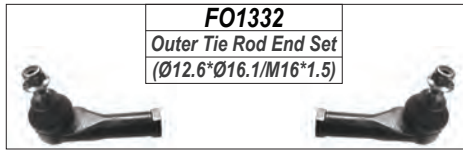

**FO1332**  
Outer Tie Rod End Set  
(Ø12.6\*Ø16.1/M16\*1.5)

**FO1018**  
Outer Tie Rod End  
(Ø12.6\*Ø16.1/M16\*1.5)

**JA1411**  
Rack End  
(16\*1.5/16\*1.5/342)



**FO1530**  
Link Stabilizer  
L=249

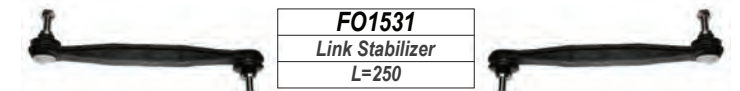

**FO1531**  
Link Stabilizer  
L=250

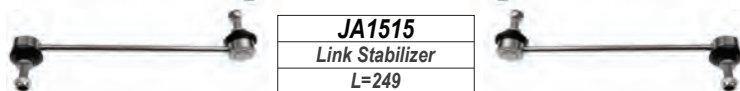

**JA1515**  
Link Stabilizer  
L=249

**FO2133**  
Lower Control Arm Bush

**FO1928**  
Lower Ball Joint  
(Ø14.4)



**FO1928**  
Lower Ball Joint  
(Ø14.4)

**FO2060**  
Lower Control Arm

**FO2061**  
Lower Control Arm

**FO2134**  
Lower Control Arm Bush

X-TYPE

REAR

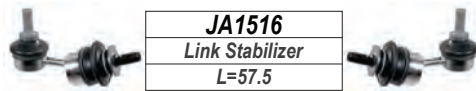

**JA1516**  
Link Stabilizer  
L=57.5

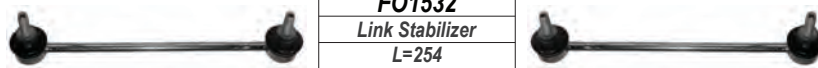

**FO1532**  
Link Stabilizer  
L=254



**FO2615**  
Link Stabilizer  
L=571



**FO2616**  
Link Stabilizer  
L=548.5

LEFT

RIGHT

**JAGUAR**

**XF**

**FRONT**

**ALL MODEL**

*Year*

**2008-2015**

**JA1016**  
Outer Tie Rod End  
(Ø14\*2/Ø27/M14\*1.5)

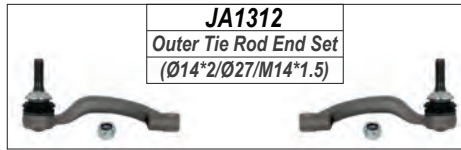

**JA1412**  
Rack End  
(16\*1.5/14\*1.5/225.5)



**JA1017**  
Outer Tie Rod End  
(Ø14\*2/Ø27/M14\*1.5)



**JA1510**  
Link Stabilizer  
L=146

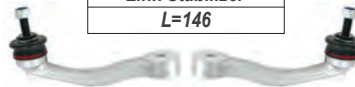

**JA1712**  
Upper Control Arm

**JA1713**  
Upper Control Arm

**XF**

**REAR**

**JA1513 / JA1514**  
Link Stabilizer  
L=223



**LEFT**

**RIGHT**



**JAGUAR**

XJ-XJS

FRONT

ALL MODEL

Year

1986-1994

**JA1014**  
Outer Tie Rod End  
(Ø13\*Ø14.5/M14\*1.5)

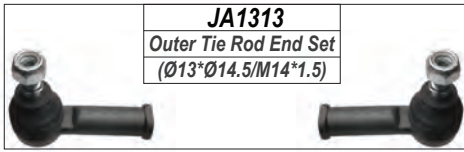

**JA1313**  
Outer Tie Rod End Set  
(Ø13\*Ø14.5/M14\*1.5)

**JA1014**  
Outer Tie Rod End  
(Ø13\*Ø14.5/M14\*1.5)

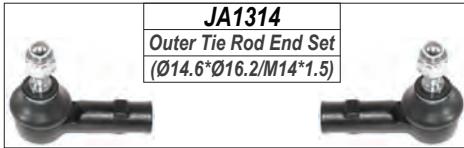

**JA1314**  
Outer Tie Rod End Set  
(Ø14.6\*Ø16.2/M14\*1.5)

**JA1015**  
Outer Tie Rod End  
(Ø14.6\*Ø16.2/M14\*1.5)



**JA1413**  
Rack End  
(14\*1.5/295.5)

**JA1015**  
Outer Tie Rod End  
(Ø14.6\*Ø16.2/M14\*1.5)



**JA1517**  
Link Stabilizer  
L=115



**JA1518**  
Link Stabilizer  
L=139

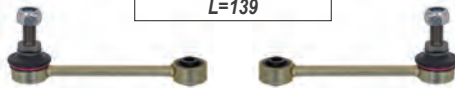

**JA1610**  
Upper Ball Joint  
(Ø19.32)



**JA1610**  
Upper Ball Joint  
(Ø19.32)



**JA1911**  
Lower Ball Joint  
(Ø16.7)



**JA1911**  
Lower Ball Joint  
(Ø16.7)



LEFT

RIGHT

**JAGUAR**

XJ

FRONT

ALL MODEL

Year

2003-2010

<b>JA1010</b>
Outer Tie Rod End
(Ø11.7*Ø25/M14*1.5)



<b>JA1410</b>
Rack End
(16*1.5/14*1.5/209)



<b>JA1010</b>
Outer Tie Rod End
(Ø11.7*Ø25/M14*1.5)



<b>JA1510</b>
Link Stabilizer
L=146



XJ

REAR

<b>JA1513 / JA1514</b>
Link Stabilizer
L=223



<b>JA1519</b>
Link Stabilizer
L=530



LEFT

RIGHT

**JAGUAR**

XJ

FRONT

ALL MODEL

Year

2010-

<b>JA1016</b>
Outer Tie Rod End
(Ø14*2/Ø27/M14*1.5)

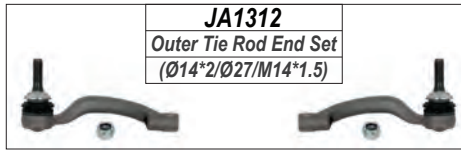

<b>JA1017</b>
Outer Tie Rod End
(Ø14*2/Ø27/M14*1.5)



<b>JA1510</b>
Link Stabilizer
L=146

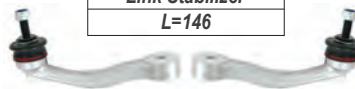

XJ

REAR

<b>JA1513 / JA1514</b>
Link Stabilizer
L=223



LEFT

RIGHT

**JAGUAR**

XK

FRONT

ALL MODEL

Year

2009-2015

**JA1016**  
Outer Tie Rod End  
(Ø14\*2/Ø27/M14\*1.5)

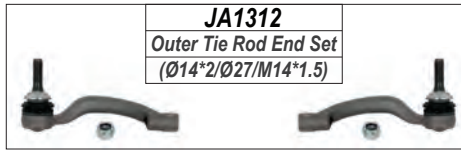

**JA1312**  
Outer Tie Rod End Set  
(Ø14\*2/Ø27/M14\*1.5)

**JA1412**  
Rack End  
(16\*1.5/14\*1.5/225.5)



**JA1017**  
Outer Tie Rod End  
(Ø14\*2/Ø27/M14\*1.5)



**JA1510**  
Link Stabilizer  
L=146

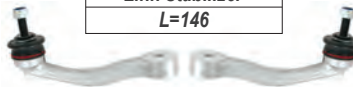

**JA1710**  
Upper Control Arm

**JA1711**  
Upper Control Arm

XK

REAR

**JA1513 / JA1514**  
Link Stabilizer  
L=223



**JA1519**  
Link Stabilizer  
L=530



LEFT

RIGHT

**JEEP**

**CHEROKEE**

**FRONT**

**XJ.ZJ.I**

*Year*

**1984-2001**

**JE1010**  
Outer Tie Rod End (LHT)  
(Ø15\*Ø15.9/M17\*1.5)



**JE1011**  
Outer Tie Rod End  
(Ø14.1\*Ø15.8/M22\*1.5)



**JE1026**  
Outer Tie Rod End(RHT)  
(Ø15\*Ø15.9/M17\*1.5)



**JE1610**  
Upper Ball Joint  
(Ø15.85)



**JE1610**  
Upper Ball Joint  
(Ø15.85)



**JE1910**  
Lower Ball Joint  
(Ø18.3)



**JE1910**  
Lower Ball Joint  
(Ø18.3)



**LEFT**

**RIGHT**



**JEEP**

**CHEROKEE**

**FRONT**

**II.KJ**

*Year*

**2002-2008**

**JE1012**  
Outer Tie Rod End  
(Ø14\*Ø15.9/M16\*1.5)

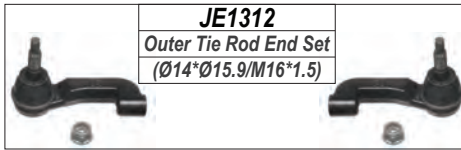

**JE1312**  
Outer Tie Rod End Set  
(Ø14\*Ø15.9/M16\*1.5)

**JE1410**  
Rack End  
(24\*1.5/16\*1.5/282)



**JE1013**  
Outer Tie Rod End  
(Ø14\*Ø15.9/M16\*1.5)

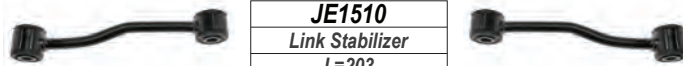

**JE1510**  
Link Stabilizer  
L=203



**JE1710**  
Upper Control Arm



**JE1710**  
Upper Control Arm



**JE1911**  
Lower Ball Joint  
(Ø17)



**JE2010**  
Lower Control Arm

**JE2011**  
Lower Control Arm



**JE1911**  
Lower Ball Joint  
(Ø17)

**JE2810**  
Shock Mounting



**JE2811**  
Shock Mounting



**LEFT**

**RIGHT**

**JEEP**

**CHEROKEE**

**FRONT**

**KK**

*Year*

**2008-2014**

**DO1010**  
Outer Tie Rod End  
(Ø15.5\*Ø18.9/M16\*1.5)

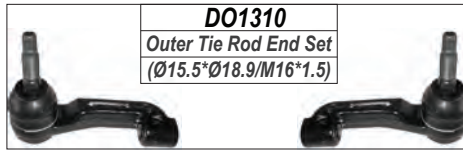

**DO1310**  
Outer Tie Rod End Set  
(Ø15.5\*Ø18.9/M16\*1.5)

**DO1411**  
Rack End  
(18\*1.5/16\*1.5/285.9)

**DO1011**  
Outer Tie Rod End  
(Ø15.5\*Ø18.9/M16\*1.5)



**CR1513**  
Link Stabilizer  
L=180.5



**CR1514**  
Link Stabilizer  
L=270



**DO1912**  
Lower Ball Joint  
(Ø17.25)



**DO2012**  
Lower Control Arm

**DO2013**  
Lower Control Arm

**DO1912**  
Lower Ball Joint  
(Ø17.25)



**LEFT**

**RIGHT**

**JEEP**

**COMPASS**

**FRONT**

**2.0 CRD. 2.4. 2.0**

**Year**

**2007-2013**

**CR1011**  
Outer Tie Rod End  
(Ø12.6\*Ø16/M14\*1.5)

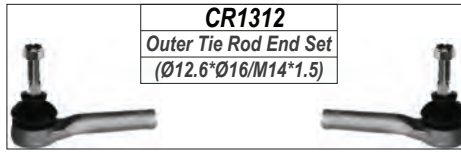

**CR1312**  
Outer Tie Rod End Set  
(Ø12.6\*Ø16/M14\*1.5)

**DO1410**  
Rack End  
(14\*1.5/14\*1.5/298.5)

**CR1011**  
Outer Tie Rod End  
(Ø12.6\*Ø16/M14\*1.5)



**CI1516**  
Link Stabilizer  
L=265



**JE2111**  
Lower Control Arm Bush



**CI1910**  
Lower Ball Joint  
(Ø20)



**JE2012**  
Lower Control Arm



**JE2013**  
Lower Control Arm

**CI1910**  
Lower Ball Joint  
(Ø20)



**JE2110**  
Lower Control Arm Bush



**DO2810**  
Shock Mounting



**DO2810**  
Shock Mounting



**LEFT**

**RIGHT**

**JEEP**

**GRAND CHEROKEE FRONT**

WJ.2.7.3.1.4.0.4.7

Year

1998-2005

**JE1014**  
Outer Tie Rod End  
(Ø14.2\*Ø15.95/M24\*1.5)



**JE1313**  
Outer Tie Rod End Set  
(Ø14.2\*Ø15.95/M24\*1.5)

**JE1015**  
Outer Tie Rod End  
(Ø14.2\*Ø15.95/M24\*1.5)

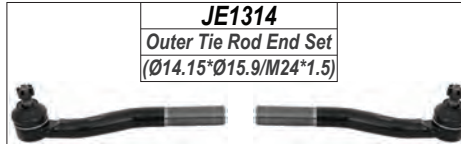

**JE1314**  
Outer Tie Rod End Set  
(Ø14.15\*Ø15.9/M24\*1.5)

**JE1016**  
Outer Tie Rod End  
(Ø14.15\*Ø15.9/M24\*1.5)



**JE1017**  
Outer Tie Rod End  
(Ø14.15\*Ø15.9/M24\*1.5)

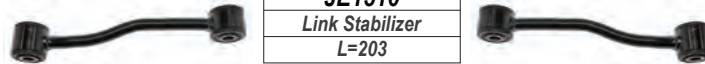

**JE1510**  
Link Stabilizer  
L=203

**JE1614**  
Upper Ball Joint  
(Ø15.85)



**JE1713**  
Upper Control Arm

**JE1713**  
Upper Control Arm

**JE1614**  
Upper Ball Joint  
(Ø15.85)



**JE1912**  
Lower Ball Joint  
(Ø17.6)



**JE2014**  
Lower Control Arm

**JE2014**  
Lower Control Arm

**JE1912**  
Lower Ball Joint  
(Ø17.6)



**JE2812**  
Shock Mounting



**JE2812**  
Shock Mounting



**GRAND CHEROKEE REAR**

**JE2610**  
Lateral Link



**JE1611**  
Upper Ball Joint  
(Ø15.85)



**JE1611**  
Upper Ball Joint  
(Ø15.85)



**LEFT**

**RIGHT**

**JEEP**

**GRAND CHEROKEE FRONT**

**WK.3.0CRD.3.7.4.7.5.7.6.1**

*Year*

**2005-2010**

**JE1018**  
Outer Tie Rod End  
(Ø15\*Ø19/M16\*1.5)

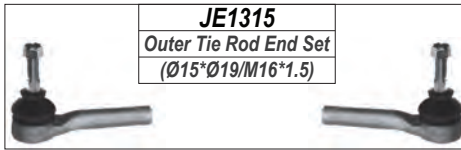

**JE1315**  
Outer Tie Rod End Set  
(Ø15\*Ø19/M16\*1.5)

**JE1019**  
Outer Tie Rod End  
(Ø15\*Ø19/M16\*1.5)



**JE1511**  
Link Stabilizer  
L=230



**JE1512**  
Link Stabilizer  
L=239.5



**JE1612**  
Upper Ball Joint  
(Ø14.5)



**JE1712**  
Upper Control Arm

**JE1712**  
Upper Control Arm

**JE1612**  
Upper Ball Joint  
(Ø14.5)



**DO1912**  
Lower Ball Joint  
(Ø17.25)



**JE2015**  
Lower Control Arm

**JE2016**  
Lower Control Arm

**DO1912**  
Lower Ball Joint  
(Ø17.25)



**JE2812**  
Shock Mounting



**JE2812**  
Shock Mounting



**LEFT**

**RIGHT**



**JEEP**

**GRAND CHEROKEE FRONT**

**WK2.3.0CRD.3.6**

*Year*

**2011-**

**JE1316**  
Outer Tie Rod End Set  
(Ø14.7\*Ø18.3/M18\*1.5)



**JE1024**  
Outer Tie Rod End  
(Ø14.7\*Ø18.3/M18\*1.5)



**JE1411**  
Rack End  
(16\*1.5/18\*1.5/218)



**JE1025**  
Outer Tie Rod End  
(Ø14.7\*Ø18.3/M18\*1.5)



**JE1513 / JE1514**  
Link Stabilizer  
L=132



**JE1613**  
Upper Ball Joint  
(Ø16.75)



**JE1714**  
Upper Control Arm



**JE1715**  
Upper Control Arm

**JE1613**  
Upper Ball Joint  
(Ø16.75)



**JE1913**  
Lower Ball Joint  
(Ø18)



**JE2017**  
Lower Control Arm

**JE2018**  
Lower Control Arm

**JE1913**  
Lower Ball Joint  
(Ø18)



**JE2812**  
Shock Mounting



**JE2812**  
Shock Mounting



**LEFT**

**RIGHT**

**JEEP**

**PATRIOT**

**FRONT**

**2.0CRD.2.4**

*Year*

**2007-**

**CR1312**  
Outer Tie Rod End Set  
(Ø12.6\*Ø16/M14\*1.5)

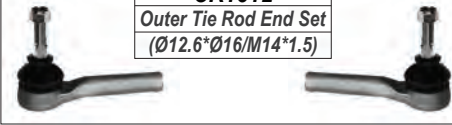

**CR1011**  
Outer Tie Rod End  
(Ø12.6\*Ø16/M14\*1.5)



**DO1410**  
Rack End  
(14\*1.5/14\*1.5/298)



**CR1011**  
Outer Tie Rod End  
(Ø12.6\*Ø16/M14\*1.5)



**CI1516**  
Link Stabilizer  
L=265



**JE2111**  
Lower Control Arm Bush



**DO1911**  
Lower Ball Joint  
(Ø19.9)



**DO1911**  
Lower Ball Joint  
(Ø19.9)

**JE2012**  
Lower Control Arm

**JE2013**  
Lower Control Arm

**JE2110**  
Lower Control Arm Bush



**DO2810**  
Shock Mounting



**DO2810**  
Shock Mounting



**LEFT**

**RIGHT**

**JEEP**

**RENEGADE**

**FRONT**

**ALL MODEL**

*Year*

**2015-**

**JE1020**  
Outer Tie Rod End  
(Ø11.7\*Ø14.8/M14\*1.5)

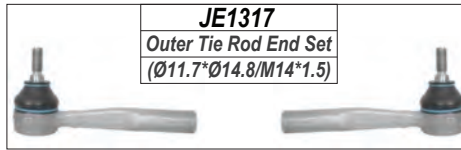

**JE1021**  
Outer Tie Rod End  
(Ø11.7\*Ø14.8/M14\*1.5)



**FI1511**  
Link Stabilizer  
L=280.5



**FI2114**  
Lower Control Arm Bush

**FI1911**  
Lower Ball Joint  
(Ø18.9)



**FI1911**  
Lower Ball Joint  
(Ø18.9)

**JE2019**  
Lower Control Arm

**JE2020**  
Lower Control Arm

**FI2115**  
Lower Control Arm Bush

**JE1515**  
Link Stabilizer  
L=183.5



**RENEGADE**

**REAR**

**LEFT**

**RIGHT**

**JEEP**

**WRANGLER**

**FRONT**

Year

2007-

**ALL MODEL**

**JE1022**  
Outer Tie Rod End  
(Ø16.55\*Ø18.8/M14\*1.5)



**JE1023**  
Outer Tie Rod End  
(Ø16.55\*Ø18.8/M14\*1.5)



**JE1614**  
Upper Ball Joint  
(Ø15.85)



**JE1912**  
Lower Ball Joint  
(Ø17.6)



**JE1318**  
Outer Tie Rod End Set  
(Ø16.55\*Ø18.8/M14\*1.5)

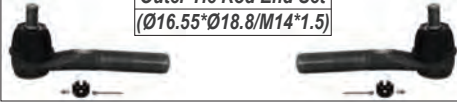

**JE1319**  
Outer Tie Rod End Set  
(Ø16.55\*Ø18.8/M14\*1.5)

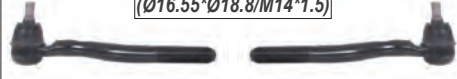

**JE1022**  
Outer Tie Rod End  
(Ø16.55\*Ø18.8/M14\*1.5)



**JE1023**  
Outer Tie Rod End  
(Ø16.55\*Ø18.8/M14\*1.5)



**JE1516**  
Link Stabilizer  
L=130



**JE1614**  
Upper Ball Joint  
(Ø15.85)



**JE1912**  
Lower Ball Joint  
(Ø17.6)



**JE2510**  
Pitman Arm



**WRANGLER**

**REAR**

**JE1517**  
Link Stabilizer  
L=280.5



**JE2611**  
Lateral Link



**JE2612**  
Lateral Link



**JE2613**  
Lateral Link



**JE2614**  
Lateral Link



**LEFT**

**RIGHT**

**KIA**

**CARENS**

**FRONT**

Year

2002-2006

II

**KI1010**  
Outer Tie Rod End  
(Ø12.5\*Ø14.4/M14\*1.5)

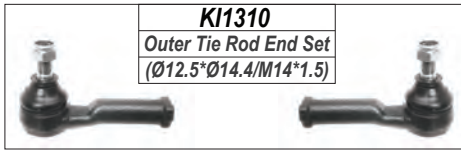

**KI1310**  
Outer Tie Rod End Set  
(Ø12.5\*Ø14.4/M14\*1.5)

**KI1010**  
Outer Tie Rod End  
(Ø12.5\*Ø14.4/M14\*1.5)

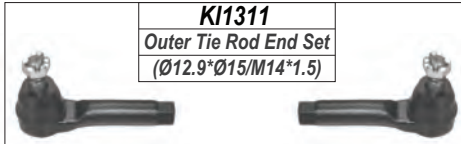

**KI1311**  
Outer Tie Rod End Set  
(Ø12.9\*Ø15/M14\*1.5)

**KI1011**  
Outer Tie Rod End  
(Ø12.9\*Ø15/M14\*1.5)



**KI1421**  
Rack End  
(16\*1.5/14\*1.5/287)

**KI1011**  
Outer Tie Rod End  
(Ø12.9\*Ø15/M14\*1.5)



**KI1510 / KI1511**  
Link Stabilizer  
L=280



**KI1910**  
Lower Ball Joint  
(Ø18)



**KI2010**  
Lower Control Arm



**KI2011**  
Lower Control Arm



**KI1910**  
Lower Ball Joint  
(Ø18)



**CARENS**

**REAR**

**KI1512**  
Link Stabilizer  
L=90.5



**LEFT**

**RIGHT**



**KIA**

**CARENS**

**FRONT**

Year

2006-

///

**KI1027**  
Outer Tie Rod End  
(Ø13.4\*Ø15.1/M16\*1.5)



**KI1410**  
Rack End  
(18\*1.5/16\*1.5/193)



**KI1028**  
Outer Tie Rod End  
(Ø13.4\*Ø15.1/M16\*1.5)



**KI1510 / KI1511**  
Link Stabilizer  
L=280



**KI1562**  
Link Stabilizer  
L=241



**KI2117**  
Lower Control Arm Bush

**HY1926**  
Lower Ball Joint  
(Ø15.1)



**KI2012**  
Lower Control Arm



**KI2013**  
Lower Control Arm

**HY1926**  
Lower Ball Joint  
(Ø15.1)



**KI2118**  
Lower Control Arm Bush

**KI1513**  
Link Stabilizer  
L=180



**CARENS**

**REAR**

**LEFT**

**RIGHT**

**KIA**

**CARNIVAL**

**FRONT**

**II**

**Year**

**2000-2005**

**KI1012**  
Outer Tie Rod End  
(Ø13.75\*Ø16/M14\*1.5)



**KI1411**  
Rack End  
(18\*1.5/14\*1.5/241)



**KI1412**  
Rack End  
(17\*1.0/14\*1.5/307)

**KI1013**  
Outer Tie Rod End  
(Ø13.75\*Ø16/M14\*1.5)



**KI1313**  
Outer Tie Rod End Set  
(Ø13.75\*Ø16/M14\*1.5)

**KI1514**  
Link Stabilizer  
L=64



**KI2014**  
Lower Control Arm

**KI2015**  
Lower Control Arm

**LEFT**

**RIGHT**

**KIA**

**CERATO**

**FRONT**

**ALL MODEL**

*Year*

**2004-2009**

**HY1010**  
Outer Tie Rod End  
(Ø13.3\*Ø15/M14\*1.5)

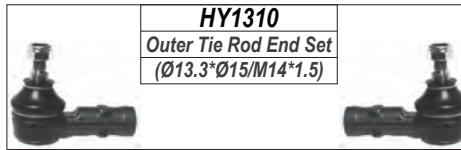

**HY1310**  
Outer Tie Rod End Set  
(Ø13.3\*Ø15/M14\*1.5)

**HY1417**  
Rack End  
(16\*1.5/14\*1.5/327)

**HY1010**  
Outer Tie Rod End  
(Ø13.3\*Ø15/M14\*1.5)



**KI1515**  
Link Stabilizer  
L=250



**HY1917**  
Lower Ball Joint  
(Ø15)



**KI2016**  
Lower Control Arm

**KI2017**  
Lower Control Arm

**HY1917**  
Lower Ball Joint  
(Ø15)



**KI2810**  
Shock Mounting



**KI2810**  
Shock Mounting



**CERATO**

**REAR**

**KI1516**  
Link Stabilizer  
L=129



**HY1520**  
Link Stabilizer  
L=130



**LEFT**

**RIGHT**

**KIA**  
**CERATO**

**FRONT**

**ALL MODEL**

**Year**

**2009-**

**HY1315**  
Outer Tie Rod End Set  
(Ø13.4\*Ø15/M14\*1.5)



**HY1023**  
Outer Tie Rod End  
(Ø13.4\*Ø15/M14\*1.5)



**HY1419**  
Rack End  
(16\*1.5/14\*1.5/163)

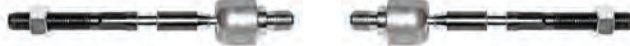

**HY1024**  
Outer Tie Rod End  
(Ø13.4\*Ø15/M14\*1.5)



**HY1536**  
Link Stabilizer  
L=243.5

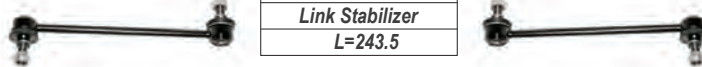

**HY2130**  
Lower Control Arm Bush



**HY1926**  
Lower Ball Joint  
(Ø15.1)



**HY1926**  
Lower Ball Joint  
(Ø15.1)



**HY2046**  
Lower Control Arm



**HY2047**  
Lower Control Arm

**HY2129**  
Lower Control Arm Bush



**HY1917**  
Lower Ball Joint  
(Ø15)



**HY2121**  
Lower Control Arm Bush



**HY1917**  
Lower Ball Joint  
(Ø15)



**KI2044**  
Lower Control Arm  
2012-



**KI2045**  
Lower Control Arm  
2012-



**HY2813**  
Shock Mounting



**HY2117**  
Lower Control Arm Bush



**HY2813**  
Shock Mounting



**LEFT**

**RIGHT**

**KIA**

**CLARUS**

**FRONT**

**ALL MODEL**

*Year*

**1998-2001**

**KI1010**  
Outer Tie Rod End  
(Ø12.5\*Ø14.4/M14\*1.5)



**KI1310**  
Outer Tie Rod End Set  
(Ø12.5\*Ø14.4/M14\*1.5)

**KI1010**  
Outer Tie Rod End  
(Ø12.5\*Ø14.4/M14\*1.5)

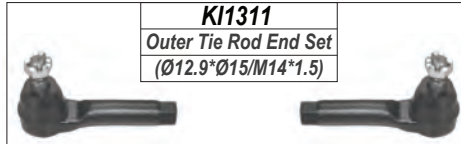

**KI1311**  
Outer Tie Rod End Set  
(Ø12.9\*Ø15/M14\*1.5)

**KI1011**  
Outer Tie Rod End  
(Ø12.9\*Ø15/M14\*1.5)



**KI1422**  
Rack End  
(16\*1.5/14\*1.5/285)

**KI1011**  
Outer Tie Rod End  
(Ø12.9\*Ø15/M14\*1.5)



**KI1510 / KI1511**  
Link Stabilizer  
L=280



**F01932**  
Lower Ball Joint  
(Ø18)



**F01932**  
Lower Ball Joint  
(Ø18)



**CLARUS**

**REAR**

**KI1512**  
Link Stabilizer  
L=90.5



**LEFT**

**RIGHT**



**KIA**

**K2700. K2500**

**FRONT**

**ALL MODEL**

**Year**

**2004-**

**FO1335**  
Outer Tie Rod End Set  
(Ø14\*Ø16/M14\*1.5)



**FO1019**  
Outer Tie Rod End  
(Ø14\*Ø16/M14\*1.5)



**FO1417**  
Rack End  
(17\*1.0/14\*1.5/182 (Man))



**FO1019**  
Outer Tie Rod End  
(Ø14\*Ø16/M14\*1.5)



**KI1423**  
Rack End  
(18\*1.5/14\*1.5/183 (Pow))



**FO1612**  
Upper Ball Joint  
(Ø17.85)



**FO1718**  
Upper Control Arm



**FO1719**  
Upper Control Arm

**FO1612**  
Upper Ball Joint  
(Ø17.85)



**KI1716**  
Upper Control Arm  
2012-



**KI1717**  
Upper Control Arm  
2012-

**FO1931**  
Lower Ball Joint  
(Ø19.75)



**KI2018**  
Lower Control Arm



**KI2019**  
Lower Control Arm

**FO1931**  
Lower Ball Joint  
(Ø19.75)



**LEFT**

**RIGHT**

**KIA**

**MAGENTIS**

**FRONT**

**ALL MODEL**

*Year*

**2004-2007**

**HY1041**  
Outer Tie Rod End  
(Ø13.45\*Ø15/M14\*1.5)

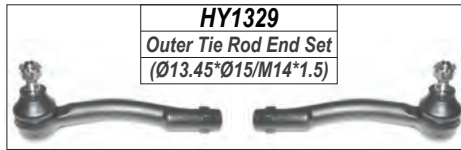

**HY1329**  
Outer Tie Rod End Set  
(Ø13.45\*Ø15/M14\*1.5)

**HY1433**  
Rack End  
(16\*1.5/14\*1.5/170)



**HY1042**  
Outer Tie Rod End  
(Ø13.45\*Ø15/M14\*1.5)



**HY1552**  
Link Stabilizer  
L=102.5



**HY1613**  
Upper Ball Joint  
(Ø13.4)



**HY1712**  
Upper Control Arm

**HY1713**  
Upper Control Arm

**HY1613**  
Upper Ball Joint  
(Ø13.4)



**HY1930**  
Lower Ball Joint  
(Ø18.1)



**HY2135**  
Lower Control Arm Bush

**HY2060**  
Lower Control Arm



**HY2134**  
Lower Control Arm Bush

**HY2061**  
Lower Control Arm



**HY1930**  
Lower Ball Joint  
(Ø18.1)



**MAGENTIS**

**REAR**

**KI1517**  
Link Stabilizer  
L=60



**LEFT**

**RIGHT**

**KIA**

**OPTIMA**

**FRONT**

**ALL MODEL**

**Year**

**2012-**

**HY1035**  
Outer Tie Rod End  
(Ø13.4\*Ø15/M16\*1.5)



**HY1326**  
Outer Tie Rod End Set  
(Ø13.4\*Ø15/M16\*1.5)

**HY1432**  
Rack End  
(16\*1.5/16\*1.5/192)



**HY1036**  
Outer Tie Rod End  
(Ø13.4\*Ø15/M16\*1.5)



**HY1557 / HY1558**  
Link Stabilizer  
L=351.5



**HY1565**  
Link Stabilizer  
L=270



**HY1927**  
Lower Ball Joint  
(Ø18)



**KI2110**  
Lower Control Arm Bush



**HY1927**  
Lower Ball Joint  
(Ø18)



**HY2064**  
Lower Control Arm

**HY2065**  
Lower Control Arm

**HY2133**  
Lower Control Arm Bush



**HY2820**  
Shock Mounting



**HY2820**  
Shock Mounting



**LEFT**

**RIGHT**

**KIA**

**PICANTO**

**FRONT**

**ALL MODEL**

**Year**

**2004-2011**

**KI1014**  
Outer Tie Rod End  
(Ø13.15\*Ø15/M12\*1.25)



**KI1314**  
Outer Tie Rod End Set  
(Ø13.15\*Ø15/M12\*1.25)

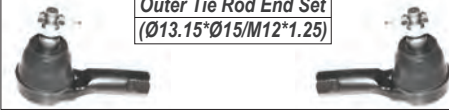

**KI1424 / KI1425**  
Rack End  
(16\*1.5/12\*1.25/281)



**KI1014**  
Outer Tie Rod End  
(Ø13.15\*Ø15/M12\*1.25)



**HY1531 / HY1532**  
Link Stabilizer  
L=230



**HY1924**  
Lower Ball Joint  
(Ø16)



**HY2116**  
Lower Control Arm Bush



**HY1924**  
Lower Ball Joint  
(Ø16)



**HY2038**  
Lower Control Arm

**HY2039**  
Lower Control Arm

**HY2125**  
Lower Control Arm Bush

**HY1917**  
Lower Ball Joint  
(Ø15)(2008-)



**HY2116**  
Lower Control Arm Bush



**HY1917**  
Lower Ball Joint  
(Ø15)(2008-)



**KI2020**  
Upper Control Arm  
2008-

**KI2021**  
Upper Control Arm  
2008-

**HY2818**  
Shock Mounting



**HY2125**  
Lower Control Arm Bush

**HY2818**  
Shock Mounting



**LEFT**

**RIGHT**



**KIA**

**PICANTO**

**FRONT**

**ALL MODEL**

**Year**

**2011-**

**KI1015 (P/S)**  
Outer Tie Rod End  
(Ø13.25\*Ø15/M14\*1.5)



**KI1315 (P/S)**  
Outer Tie Rod End Set  
(Ø13.25\*Ø15/M14\*1.5)

**KI1413 (P/S)**  
Rack End  
(20\*1.5/14\*1.25/198)



**KI1016 (P/S)**  
Outer Tie Rod End  
(Ø13.25\*Ø15/M14\*1.5)



**KI1415 (P/S)**  
Rack End(2015-)  
(16\*1.5/14\*1.5/212)

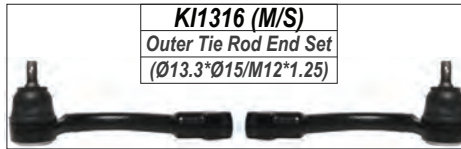

**KI1316 (M/S)**  
Outer Tie Rod End Set  
(Ø13.3\*Ø15/M12\*1.25)

**KI1017 (M/S)**  
Outer Tie Rod End  
(Ø13.3\*Ø15/M12\*1.25)



**KI1414 (M/S)**  
Rack End  
(14\*1.5/12\*1.25/218)



**KI1018 (M/S)**  
Outer Tie Rod End  
(Ø13.3\*Ø15/M12\*1.25)



**HY1533 / HY1534**  
Link Stabilizer  
L=216



**HY1925**  
Lower Ball Joint  
(Ø18)



**KI2022**  
Lower Control Arm

**KI2023**  
Lower Control Arm

**HY1925**  
Lower Ball Joint  
(Ø18)



**HY2819**  
Shock Mounting



**HY2819**  
Shock Mounting



**LEFT**

**RIGHT**



**KIA**

**PICANTO**

**FRONT**

**ALL MODEL**

*Year*

**2017-**

**KI1323**

Outer Tie Rod End Set  
(Ø13.3\*Ø15/M14\*1.5)

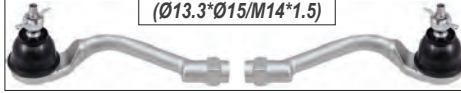

**KI1030**

Outer Tie Rod End  
(Ø13.3\*Ø15/M14\*1.5)



**KI1434**

Rack End  
(16\*1.5/14\*1.5/219)



**KI1031**

Outer Tie Rod End  
(Ø13.3\*Ø15/M14\*1.5)



**KI1539**

Link Stabilizer  
L=250



**KI1916**

Lower Ball Joint  
(Ø18)



**KI2046**

Lower Control Arm



**KI2047**

Lower Control Arm

**KI1916**

Lower Ball Joint  
(Ø18)



**LEFT**

**RIGHT**

**KIA**

**PREGIO**

**FRONT**

**ALL MODEL**

*Year*

**2001-2004**

**KI1029**  
Outer Tie Rod End  
(Ø13.8\*Ø15/M14\*1.5)

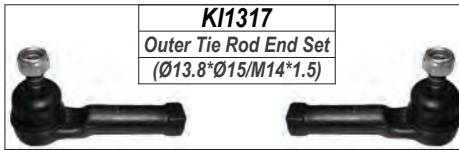

**KI1317**  
Outer Tie Rod End Set  
(Ø13.8\*Ø15/M14\*1.5)

**KI1426**  
Rack End  
(17\*1.0/14\*1.5/275)

**KI1029**  
Outer Tie Rod End  
(Ø13.8\*Ø15/M14\*1.5)



**KI1518**  
Link Stabilizer  
L=77



**KI1519**  
Link Stabilizer  
L=145.5



**KI1710**  
Upper Control Arm



**KI1711**  
Upper Control Arm



**KI1712**  
Upper Control Arm



**KI1712**  
Upper Control Arm



**KI1911**  
Lower Ball Joint  
(Ø21.6)



**KI1911**  
Lower Ball Joint  
(Ø21.6)



**LEFT**

**RIGHT**

**KIA**

**PRIDE**

**FRONT**

**ALL MODEL**

*Year*

**1998-2000**

**FO1029**  
Outer Tie Rod End  
(Ø13.2\*Ø15.1/M12\*1.25)

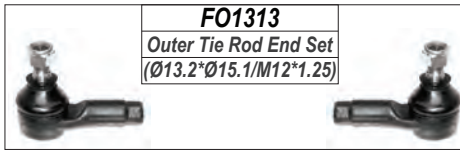

**FO1313**  
Outer Tie Rod End Set  
(Ø13.2\*Ø15.1/M12\*1.25)

**KI1427**  
Rack End  
(16\*1.5/12\*1.25/265)

**FO1029**  
Outer Tie Rod End  
(Ø13.2\*Ø15.1/M12\*1.25)



**KI2024**  
Lower Control Arm



**KI2024**  
Lower Control Arm

**LEFT**

**RIGHT**

**KIA**

**RIO**

**FRONT**

*Year*

**2000-2005**

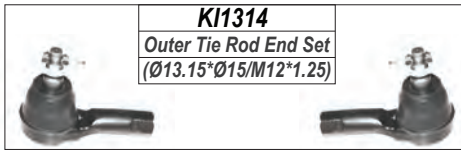

**KI1314**  
Outer Tie Rod End Set  
(Ø13.15\*Ø15/M12\*1.25)

**KI1014**  
Outer Tie Rod End  
(Ø13.15\*Ø15/M12\*1.25)



**KI1428**  
Rack End  
(16\*1.5/12\*1.25/280)



**KI1014**  
Outer Tie Rod End  
(Ø13.15\*Ø15/M12\*1.25)



**KI1429**  
Rack End  
(16\*1.5/12\*1.25/281)



**KI1520 / KI1521**  
Link Stabilizer  
L=240



**KI1522 / KI1523**  
Link Stabilizer  
L=218

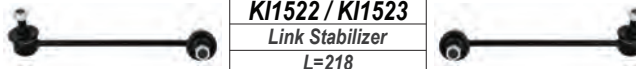

**KI2116**  
Lower Control Arm Bush



**KI2025**  
Lower Control Arm  
2000-2003



**KI2026**  
Lower Control Arm  
2000-2003



**KI2116**  
Lower Control Arm Bush



**KI2027**  
Lower Control Arm  
2003-2005



**KI2028**  
Lower Control Arm  
2003-2005



**KI2812**  
Shock Mounting



**KI2812**  
Shock Mounting



**KI2813**  
Shock Mounting



**KI2814**  
Shock Mounting



**LEFT**

**RIGHT**

**KIA**

**RIO**

**FRONT**

**II**

*Year*

**2005-2008**

**KI1019**  
Outer Tie Rod End  
(Ø13.3\*Ø15/M14\*1.5)



**KI1318**  
Outer Tie Rod End Set  
(Ø13.3\*Ø15/M14\*1.5)

**KI1416**  
Rack End  
(16\*1.5/14\*1.5/190)



**KI1020**  
Outer Tie Rod End  
(Ø13.3\*Ø15/M14\*1.5)



**HY1515 / HY1516**  
Link Stabilizer  
L=285



**HY2116**  
Lower Control Arm Bush



**HY1918**  
Lower Ball Joint  
(Ø15)



**HY1918**  
Lower Ball Joint  
(Ø15)



**HY2014**  
Lower Control Arm

**HY2015**  
Lower Control Arm

**HY2115**  
Lower Control Arm Bush



**HY2813**  
Shock Mounting



**HY2813**  
Shock Mounting



**LEFT**

**RIGHT**



**KIA**

**RIO**

**FRONT**

**III**

**Year**

**2011-**

**HY1021**  
Outer Tie Rod End  
(Ø13.25\*Ø17/M16\*1.5)



**HY1312**  
Outer Tie Rod End Set  
(Ø13.25\*Ø17/M16\*1.5)

**HY1415**  
Rack End  
(16\*1.5/16\*1.5/218)



**HY1022**  
Outer Tie Rod End  
(Ø13.25\*Ø17/M16\*1.5)



**KI1015**  
Outer Tie Rod End  
(Ø13.25\*Ø15/M14\*1.5)



**KI1315**  
Outer Tie Rod End Set  
(Ø13.25\*Ø15/M14\*1.5)

**HY1437**  
Rack End  
(14\*1.5/14\*1.5/219)



**KI1016**  
Outer Tie Rod End  
(Ø13.25\*Ø15/M14\*1.5)



**HY1517**  
Link Stabilizer  
L=282.5



**HY1925**  
Lower Ball Joint  
(Ø18)



**HY2116**  
Lower Control Arm Bush



**KI2029**  
Lower Control Arm

**KI2030**  
Lower Control Arm

**HY1925**  
Lower Ball Joint  
(Ø18)



**HY2115**  
Lower Control Arm Bush



**HY2819**  
Shock Mounting



**HY2819**  
Shock Mounting



**LEFT**

**RIGHT**

**KIA**

**SEDONA**

**FRONT**

**ALL MODEL**

**Year**

**2007-**

**KI1021**  
Outer Tie Rod End  
(Ø13.8\*Ø16/M16\*1.5)



**KI1319**  
Outer Tie Rod End Set  
(Ø13.8\*Ø16/M16\*1.5)

**KI1417**  
Rack End  
(16\*1.5/16\*1.5/212)



**KI1022**  
Outer Tie Rod End  
(Ø13.8\*Ø16/M16\*1.5)



**KI1524 / KI1525**  
Link Stabilizer  
L=285



**HY2140**  
Lower Control Arm Bush



**HY1921**  
Lower Ball Joint  
(Ø20)



**KI2041**  
Lower Control Arm



**HY2139**  
Lower Control Arm Bush



**KI2042**  
Lower Control Arm



**HY1921**  
Lower Ball Joint  
(Ø20)



**HY2817**  
Shock Mounting



**HY2817**  
Shock Mounting



**LEFT**

**RIGHT**

**KIA**

**SEPHIA**

**FRONT**

**ALL MODEL**

*Year*

**1998-2001**

**KI1011**  
Outer Tie Rod End  
(Ø12.9\*Ø15/M14\*1.5)

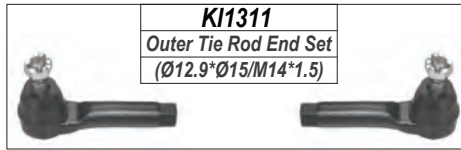

**KI1311**  
Outer Tie Rod End Set  
(Ø12.9\*Ø15/M14\*1.5)

**KI1430**  
Rack End  
(16\*1.5/14\*1.5/277)

**KI1011**  
Outer Tie Rod End  
(Ø12.9\*Ø15/M14\*1.5)



**F01912**  
Lower Ball Joint  
(Ø16)



**F01912**  
Lower Ball Joint  
(Ø16)

**KI2815**  
Shock Mounting



**KI2815**  
Shock Mounting



**LEFT**

**RIGHT**

**KIA**

**SHUMA**

**FRONT**

**ALL MODEL**

*Year*

**1998-2004**

**KI1011**  
Outer Tie Rod End  
(Ø12.9\*Ø15/M14\*1.5)

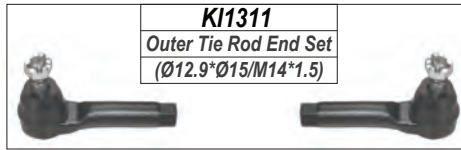

**KI1311**  
Outer Tie Rod End Set  
(Ø12.9\*Ø15/M14\*1.5)

**KI1431**  
Rack End  
(16\*1.5/14\*1.5/293)

**KI1011**  
Outer Tie Rod End  
(Ø12.9\*Ø15/M14\*1.5)



**KI1526 / KI1527**  
Link Stabilizer  
L=274



**KI1528**  
Link Stabilizer  
L=85



**FO1912**  
Lower Ball Joint  
(Ø16)



**FO1912**  
Lower Ball Joint  
(Ø16)



**KI1910**  
Lower Ball Joint  
(Ø18)



**KI1910**  
Lower Ball Joint  
(Ø18)



**KI2815**  
Shock Mounting



**KI2815**  
Shock Mounting



**LEFT**

**RIGHT**

**KIA**

**SORENTO**

**FRONT**

**ALL MODEL**

*Year*

**2003-2009**

**KI1023**  
Outer Tie Rod End  
(Ø13.85\*Ø16.1/M14\*1.5)



**KI1320**  
Outer Tie Rod End Set  
(Ø13.85\*Ø16.1/M14\*1.5)

**KI1432**  
Rack End  
(18\*1.5/14\*1.5/172)



**KI1024**  
Outer Tie Rod End  
(Ø13.85\*Ø16.1/M14\*1.5)



**KI1529**  
Link Stabilizer  
L=149.5



**KI1530 / KI1531**  
Link Stabilizer  
L=85



**KI1713**  
Upper Control Arm

**KI1714**  
Upper Control Arm

**KI1810**  
Upper Control Arm Bush

**KI2031**  
Lower Control Arm

**KI2032**  
Lower Control Arm

**KI1913**  
Lower Ball Joint  
(Ø21.7)



**KI2111**  
Lower Control Arm Bush

**KI1913**  
Lower Ball Joint  
(Ø21.7)

**KI2112**  
Lower Control Arm Bush

**KI2112**  
Lower Control Arm Bush

**KI2816**  
Shock Mounting



**KI2816**  
Shock Mounting



**SORENTO**

**REAR**

**KI1532 / KI1533**  
Link Stabilizer  
L=120



**LEFT**

**RIGHT**



**KIA**

**SORENTO**

**FRONT**

**ALL MODEL**

*Year*

**2009-2014**

**HY1037**  
Outer Tie Rod End  
(Ø13.9\*Ø16/M16\*1.5)



**HY1327**  
Outer Tie Rod End Set  
(Ø13.9\*Ø16/M16\*1.5)

**KI1418 / KI1419**  
Rack End  
(18\*1.5/16\*1.5/172)



**HY1038**  
Outer Tie Rod End  
(Ø13.9\*Ø16/M16\*1.5)



**HY1546 / HY1547**  
Link Stabilizer  
L=341



**KI1534 / KI1535**  
Link Stabilizer  
L=85



**HY1929**  
Lower Ball Joint  
(Ø20)



**HY2139**  
Lower Control Arm Bush

**KI2039**  
Lower Control Arm

**HY2140**  
Lower Control Arm Bush

**KI2040**  
Lower Control Arm

**HY1929**  
Lower Ball Joint  
(Ø20)



**KI2817**  
Shock Mounting



**KI2817**  
Shock Mounting



**LEFT**

**RIGHT**

**KIA**

**SORENTO**

**FRONT**

**ALL MODEL**

**Year**

**2015-**

**HY1047**  
Outer Tie Rod End  
(Ø13.85\*Ø16.1/M14\*1.5)

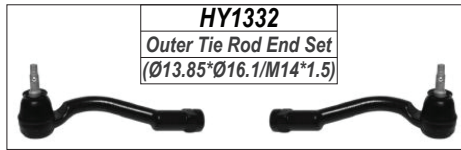

**HY1332**  
Outer Tie Rod End Set  
(Ø13.85\*Ø16.1/M14\*1.5)

**KI1420**  
Rack End  
(16\*1.5/14\*1.5/242.5)



**HY1048**  
Outer Tie Rod End  
(Ø13.85\*Ø16.1/M14\*1.5)



**KI1914**  
Lower Ball Joint  
(Ø18)



**KI2033**  
Lower Control Arm

**KI2034**  
Lower Control Arm

**KI1914**  
Lower Ball Joint  
(Ø18)



**LEFT**

**RIGHT**

**KIA**

**SOUL**

**FRONT**

**AM**

*Year*

**2009-2014**

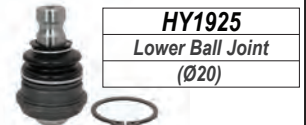
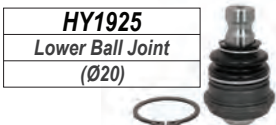
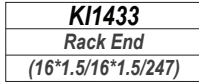
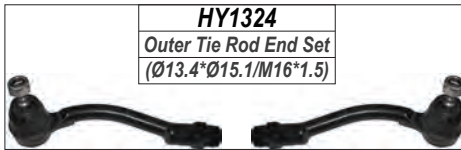

**LEFT**

**RIGHT**

**KIA**

**SPORTAGE**

**FRONT**

**ALL MODEL**

*Year*

**1999-2005**

**KI1321**

*Outer Tie Rod End Set*  
(Ø13.1\*Ø15/M18\*1.5)

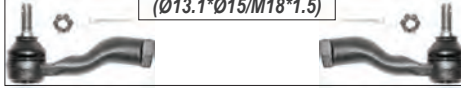

**KI1322**

*Inner Tie Rod End Set*  
(Ø14.6\*Ø16/M18\*1.5)



**KI1025**

*Outer Tie Rod End*  
(Ø13.1\*Ø15/M18\*1.5)



**KI1110 / KI1111**

*Inner Tie Rod End*  
(Ø14.6\*Ø16/M18\*1.5)



**KI1026**

*Outer Tie Rod End*  
(Ø13.1\*Ø15/M18\*1.5)



**KI1210 / KI1211**

*Tie Rod End Assembly*



**KI1519**

*Link Stabilizer*  
L=145.5



**KI1715**

*Upper Control Arm*

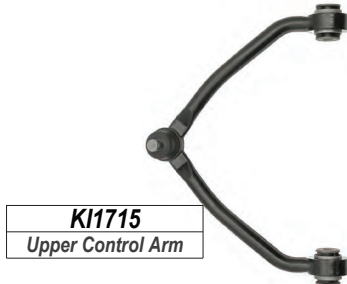

**KI1715**

*Upper Control Arm*



**KI1915**

*Lower Ball Joint*  
(Ø17.8)



**KI1915**

*Lower Ball Joint*  
(Ø17.8)



**KI2819**

*Shock Mounting*



**KI2043**

*Lower Control Arm*



**KI2043**

*Lower Control Arm*



**KI2819**

*Shock Mounting*



**LEFT**

**RIGHT**

**KIA**

**SPORTAGE**

**FRONT**

**ALL MODEL**

*Year*

**2005-2010**

**HY1045**  
Outer Tie Rod End  
(Ø13.45\*Ø15/M16\*1.5)



**HY1331**  
Outer Tie Rod End Set  
(Ø13.45\*Ø15/M16\*1.5)

**HY1435**  
Rack End  
(16\*1.5/16\*1.5/241)



**HY1046**  
Outer Tie Rod End  
(Ø13.45\*Ø15/M16\*1.5)



**HY1510**  
Link Stabilizer  
L=238



**HY2130**  
Lower Control Arm Bush



**HY1932**  
Lower Ball Joint  
(Ø14.55)



**HY1932**  
Lower Ball Joint  
(Ø14.55)



**HY2066**  
Lower Control Arm

**HY2067**  
Lower Control Arm

**KI2115**  
Lower Control Arm Bush

**SORENTO**

**REAR**

**HY1563**  
Link Stabilizer  
L=219



**LEFT**

**RIGHT**



**KIA**

**SPORTAGE**

**FRONT**

**ALL MODEL**

*Year*

**2010-2015**

**HY1035**  
Outer Tie Rod End  
(Ø13.4\*Ø15/M16\*1.5)



**HY1326**  
Outer Tie Rod End Set  
(Ø13.4\*Ø15/M16\*1.5)

**HY1429**  
Rack End  
(16\*1.5/16\*1.5/183)



**HY1036**  
Outer Tie Rod End  
(Ø13.4\*Ø15/M16\*1.5)



**HY1539**  
Link Stabilizer  
L=267



**HY2132**  
Lower Control Arm Bush

**HY1928**  
Lower Ball Joint  
(Ø18)



**HY1928**  
Lower Ball Joint  
(Ø18)

**HY2050**  
Lower Control Arm

**HY2051**  
Lower Control Arm

**HY2822**  
Shock Mounting



**HY2133**  
Lower Control Arm Bush



**HY2822**  
Shock Mounting



**SPORTAGE**

**REAR**

**HY1541**  
Link Stabilizer  
L=140



**HY2823**  
Shock Mounting



**KI1538**  
Link Stabilizer  
L=90



**HY2823**  
Shock Mounting



**LEFT**

**RIGHT**

**KIA**

**SPORTAGE**

**FRONT**

**ALL MODEL**

*Year*

**2015-**

**HY1047**  
Outer Tie Rod End  
(Ø13.85\*Ø16.1/M14\*1.5)



**HY1436**  
Rack End  
(16\*1.5/14\*1.5/242.5)



**HY1048**  
Outer Tie Rod End  
(Ø13.85\*Ø16.1/M14\*1.5)



**HY1535**  
Link Stabilizer  
L=282.5



**HY1915**  
Lower Ball Joint  
(Ø18)



**HY2068**  
Lower Control Arm

**HY2069**  
Lower Control Arm

**HY1916**  
Lower Ball Joint  
(Ø18)



**SPORTAGE**

**REAR**

**HY1564**  
Link Stabilizer  
L=140



**LEFT**

**RIGHT**

**LAND ROVER**

**DEFENDER**

**FRONT**

**ALL MODEL**

*Year*

**1996-2007**

**LR2210**

Center Rod



**LR1310**

Outer Tie Rod End Set  
(Ø15\*Ø17.5/M12\*1.5)

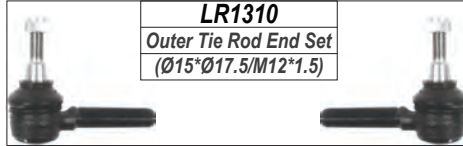

**LR1010**

Outer Tie Rod End  
(Ø15\*Ø17.5/M12\*1.5)



**LR1011**

Outer Tie Rod End  
(Ø15\*Ø17.5/M12\*1.5)



**LR1510**

Link Stabilizer  
L=64



**LR1910**

Lower Ball Joint  
(Ø23)



**LR1910**

Lower Ball Joint  
(Ø23)



**DEFENDER**

**REAR**

**LR1911**

Lower Ball Joint  
(Ø20)



**LR1911**

Lower Ball Joint  
(Ø20)



**LEFT**

**RIGHT**

**LAND ROVER**

**DISCOVERY**

**FRONT**

Year

1990-1999

**LR2211**  
Center Road  
L=1320



**LR2212**  
Center Road  
L=940

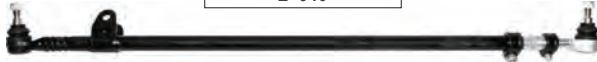

**LR2213**  
Center Road  
L=920

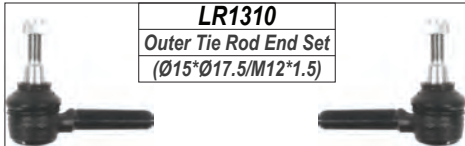
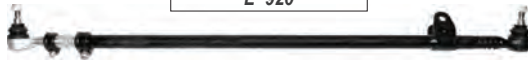

**LR1310**  
Outer Tie Rod End Set  
(Ø15\*Ø17.5/M12\*1.5)

**LR1010**  
Outer Tie Rod End  
(Ø15\*Ø17.5/M12\*1.5)



**LR1011**  
Outer Tie Rod End  
(Ø15\*Ø17.5/M12\*1.5)



**LR1510**  
Link Stabilizer  
L=64



**LR1511**  
Link Stabilizer  
L=170



**LR1910**  
Lower Ball Joint  
(Ø23)



**LR1910**  
Lower Ball Joint  
(Ø23)



**LR1911**  
Lower Ball Joint  
(Ø20)



**LR1911**  
Lower Ball Joint  
(Ø20)



**LEFT**

**RIGHT**

**LAND ROVER**

**DISCOVERY**

**FRONT**

II

Year

1999-2005

**LR2211**  
Center Road  
L=1320



**LR2212**  
Center Road  
L=940

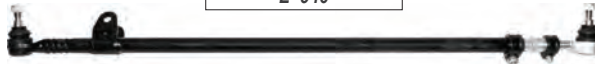

**LR2213**  
Center Road  
L=920

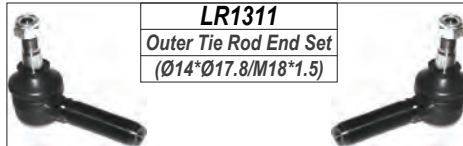
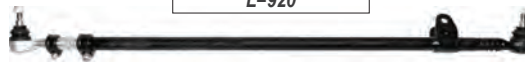

**LR1311**  
Outer Tie Rod End Set  
(Ø14\*Ø17.8/M18\*1.5)

**LR1012**  
Outer Tie Rod End  
(Ø14\*Ø17.8/M18\*1.5)



**LR1013**  
Outer Tie Rod End  
(Ø14\*Ø17.8/M18\*1.5)



**LR1512**  
Link Stabilizer  
L=217.5



**LR1610**  
Upper Ball Joint  
(Ø15.8)



**LR1610**  
Upper Ball Joint  
(Ø15.8)



**LR1910**  
Lower Ball Joint  
(Ø19.6)



**LR1910**  
Lower Ball Joint  
(Ø19.6)



**LEFT**

**RIGHT**



**LAND ROVER**

**DISCOVERY**

**FRONT**

**III . IV**

**Year**

**2005-**

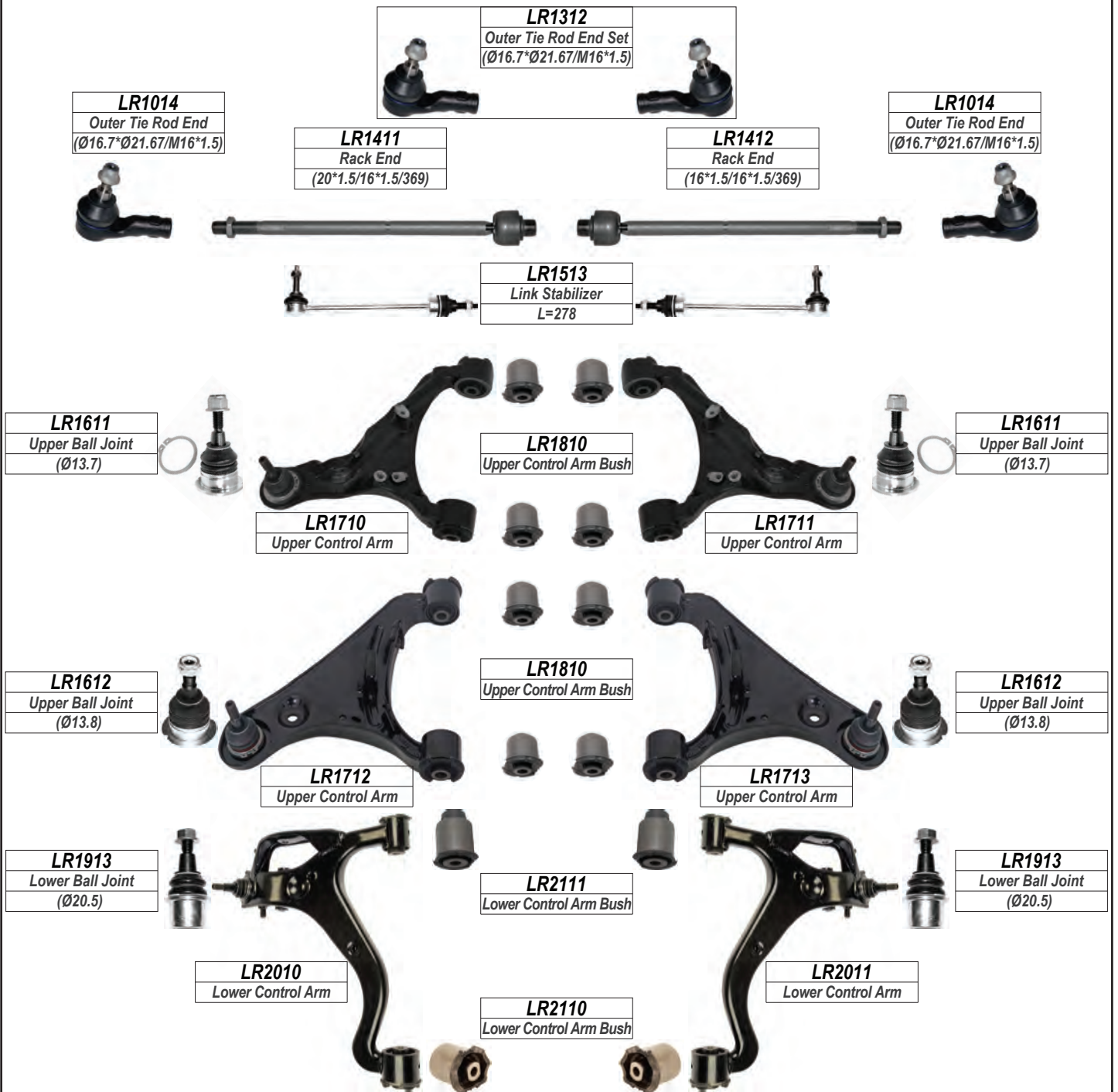

**DISCOVERY**

**REAR**



**LEFT**  **RIGHT**

# LAND ROVER

**FREELANDER**
**FRONT**

Year

1997-2006

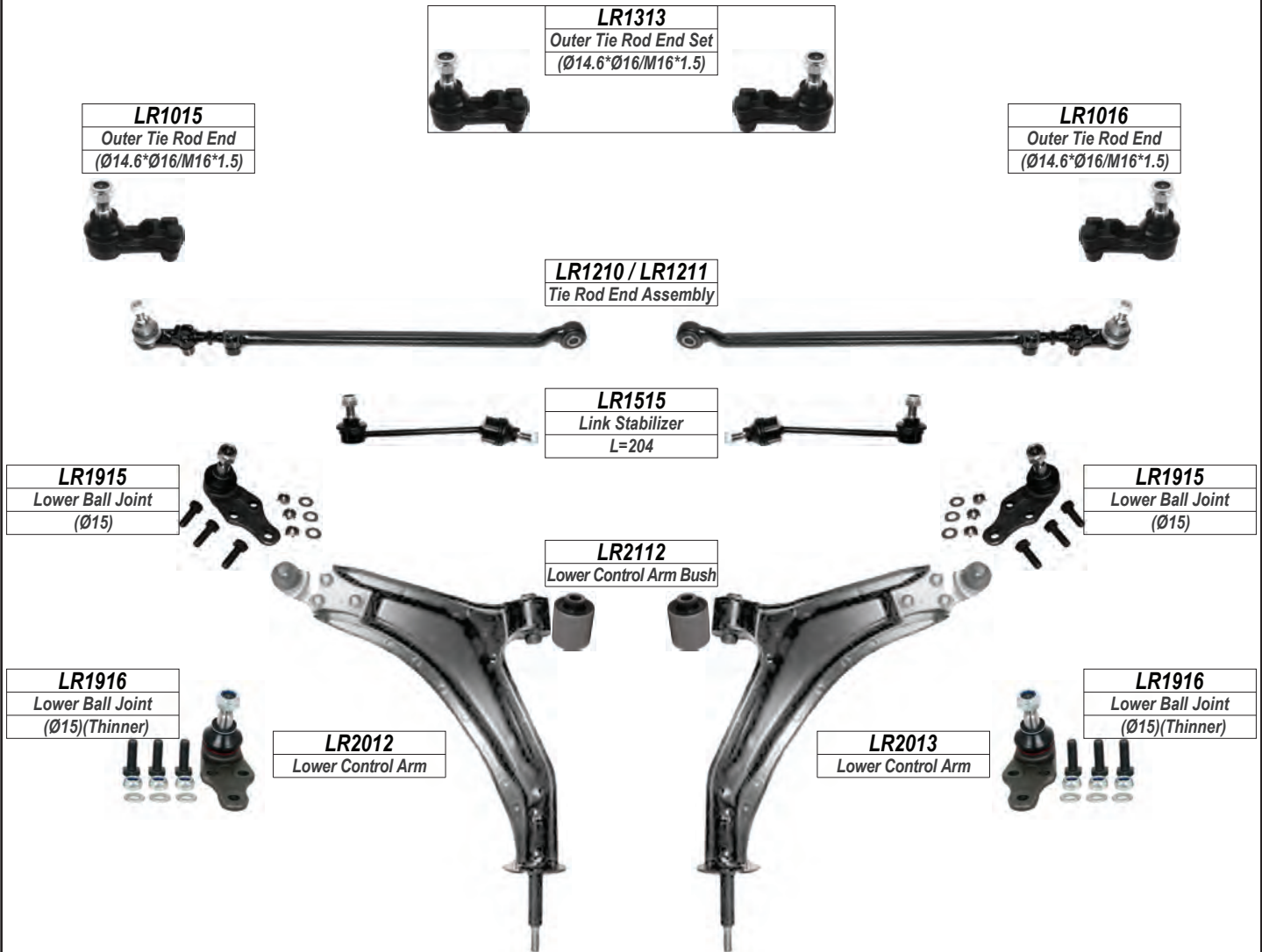
**FREELANDER**
**REAR**

# LEFT

# RIGHT

**LAND ROVER**

**FREELANDER**

**FRONT**

Year

2006-

II

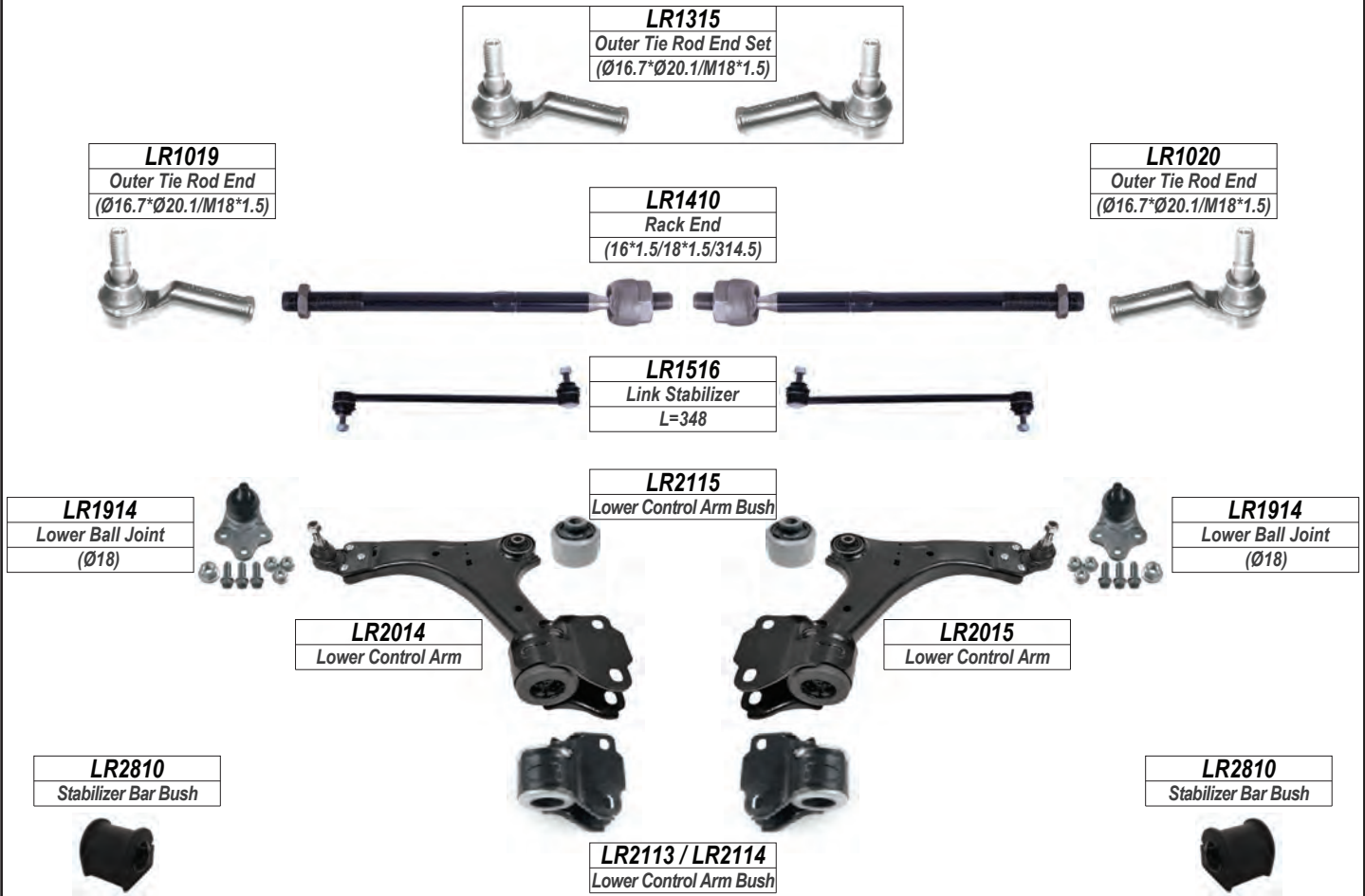

**FREELANDER**

**REAR**



**LEFT**

**RIGHT**

**LAND ROVER**

**RANGE ROVER FRONT  
EVOQUE (LV)**

Year

2011-

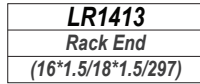
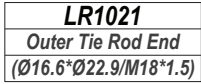
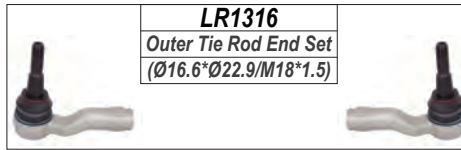

**RANGE ROVER REAR  
EVOQUE (LV)**



**LEFT**

**RIGHT**

**LAND ROVER**

**RANGE ROVER FRONT**

Year

1979-1993

**LR2216**  
Center Rod



**LR1310**  
Outer Tie Rod End Set  
(Ø15\*Ø17.5/M12\*1.5)

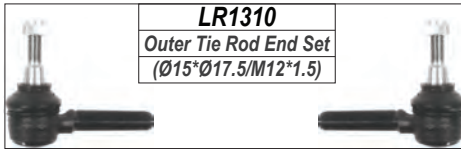

**LR1010**  
Outer Tie Rod End  
(Ø15\*Ø17.5/M12\*1.5)



**LR1011**  
Outer Tie Rod End  
(Ø15\*Ø17.5/M12\*1.5)



**LR1510**  
Link Stabilizer  
L=64



**LR1910**  
Lower Ball Joint  
(Ø23)



**LR1910**  
Lower Ball Joint  
(Ø23)



**RANGE ROVER REAR**

**LR1911**  
Lower Ball Joint  
(Ø20)



**LR1911**  
Lower Ball Joint  
(Ø20)



**LEFT**

**RIGHT**



**LAND ROVER**

**RANGE ROVER FRONT**

Year

1994-2002

||

**LR2214**

Center Rod



**LR2215**

Center Rod



**LR1311**

Outer Tie Rod End Set  
(Ø14\*Ø17.8/M18\*1.5)

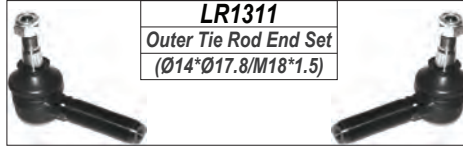

**LR1012**

Outer Tie Rod End  
(Ø14\*Ø17.8/M18\*1.5)



**LR1013**

Outer Tie Rod End  
(Ø14\*Ø17.8/M18\*1.5)



**LR1519**

Link Stabilizer  
L=97



**LR1912**

Lower Ball Joint  
(Ø23)



**LR1912**

Lower Ball Joint  
(Ø23)



**RANGE ROVER**

**REAR**

**LR1911**

Lower Ball Joint  
(Ø20)



**LR1911**

Lower Ball Joint  
(Ø20)



**LEFT**

**RIGHT**

**LAND ROVER**

**RANGE ROVER FRONT**

Year

2002-2012

III

**LR1317**  
Outer Tie Rod End Set  
(Ø15.4\*Ø18.3/M16\*1.5)



**LR1017**  
Outer Tie Rod End  
(Ø15.4\*Ø18.3/M16\*1.5)



**BM1427**  
Rack End  
(18\*1.5/16\*1.5/230)



**LR1017**  
Outer Tie Rod End  
(Ø15.4\*Ø18.3/M16\*1.5)



**LR1520**  
Link Stabilizer  
L=380



**LR1811**  
Upper Control Arm Bush



**LR1611**  
Upper Ball Joint  
(Ø13.7)



**LR1611**  
Upper Ball Joint  
(Ø13.7)



**LR1714**  
Upper Control Arm



**LR1715**  
Upper Control Arm



**LR2117**  
Lower Control Arm Bush



**LR1917**  
Lower Ball Joint  
(Ø18.45)



**LR1917**  
Lower Ball Joint  
(Ø18.45)



**LR2018**  
Lower Control Arm



**LR2018**  
Lower Control Arm



**RANGE ROVER REAR**

**REAR**

**LR1521**  
Link Stabilizer  
L=120



**LR2918**  
Bush



**LR2617**  
Lateral Link  
L=301.5

**LR2617**  
Lateral Link  
L=301.5

**LR2919**  
Bush



**LR2920**  
Bush



**LR2921**  
Bush



**LEFT**

**RIGHT**

**LAND ROVER**

**RANGE ROVER FRONT**

**SPORT**

Year

**2005-2013**

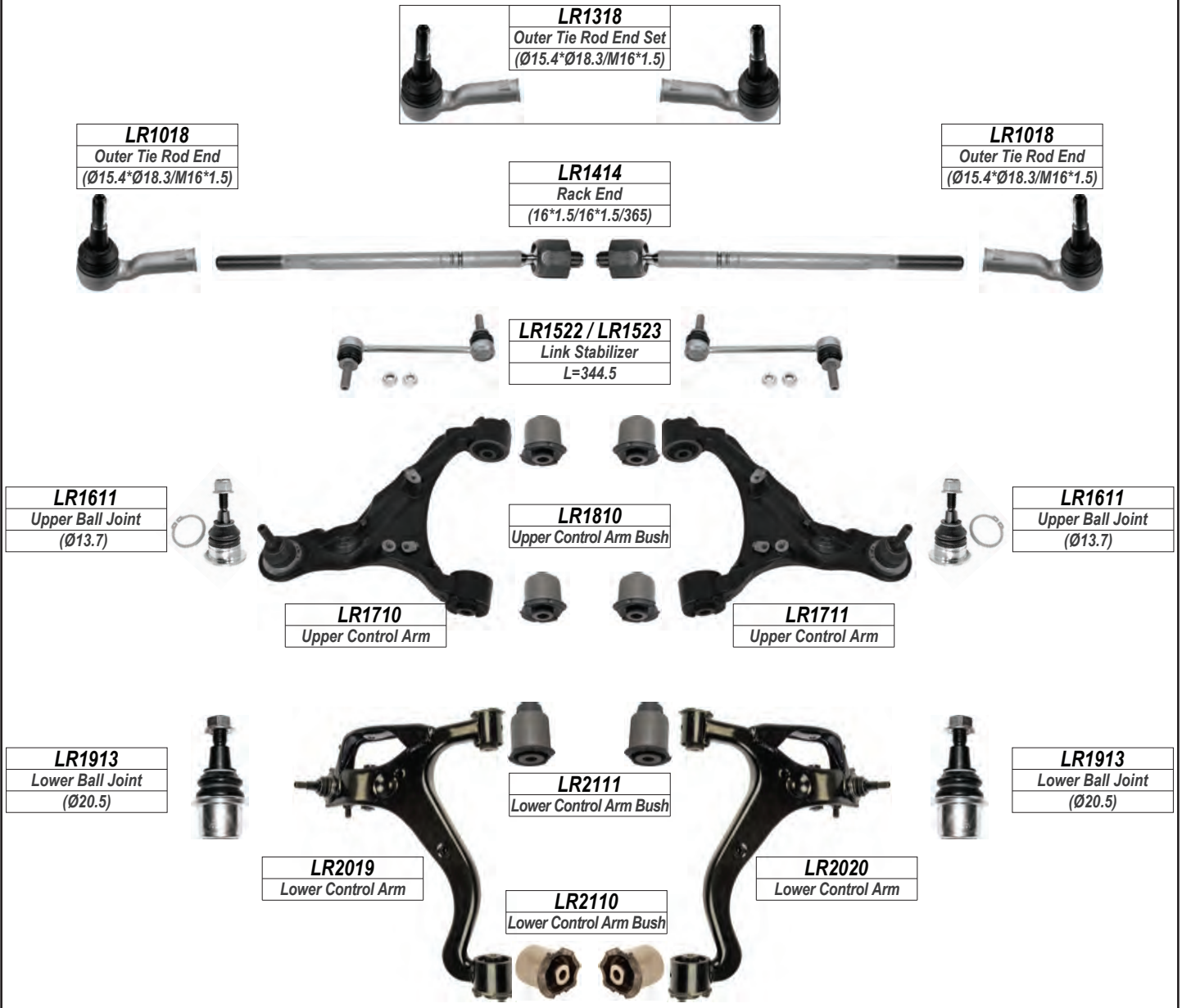

**RANGE ROVER REAR**



**LEFT**

**RIGHT**

**LAND ROVER**

RANGE ROVER

FRONT

SPORT. VOGUE

Year

2013-

**LR1023**  
Outer Tie Rod End  
(Ø16.55\*Ø22.9/M14\*1.5)

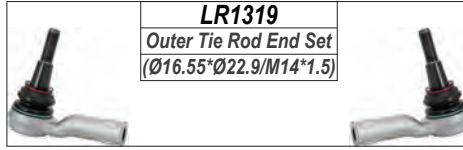

**LR1319**  
Outer Tie Rod End Set  
(Ø16.55\*Ø22.9/M14\*1.5)

**LR1415**  
Rack End  
(16\*1.5/14\*1.5/329)

**LR1023**  
Outer Tie Rod End  
(Ø16.55\*Ø22.9/M14\*1.5)

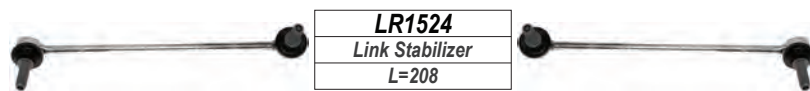

**LR1524**  
Link Stabilizer  
L=208



**LR1716**  
Upper Control Arm  
Oem Ref: LR034214

**LR1812**  
Upper Control Arm Bush



**LR1717**  
Upper Control Arm  
Oem Ref: LR034211



**LR1718**  
Upper Control Arm  
Oem Ref: LR034216

**LR1812**  
Upper Control Arm Bush



**LR1719**  
Upper Control Arm  
Oem Ref: LR034213



**LR1720**  
Upper Control Arm  
Oem Ref: LR034215

**LR1812**  
Upper Control Arm Bush



**LR1721**  
Upper Control Arm  
Oem Ref: LR034212

LEFT

RIGHT

**LAND ROVER**

**RANGE ROVER FRONT**

**SPORT. VOGUE**

Year

2013-

**LR2119**  
Lower Control Arm Bush



**LR2021**  
Lower Control Arm  
Oem Ref: LR034220

**LR2022**  
Lower Control Arm  
Oem Ref: LR034219

**LR2121**  
Lower Control Arm Bush

**LR2120**  
Lower Control Arm Bush

**LR2121**  
Lower Control Arm Bush



**LR2023**  
Lower Control Arm  
Oem Ref: LR045243

**LR2024**  
Lower Control Arm  
Oem Ref: LR045242

**LR2122**  
Lower Control Arm Bush

**LR2120**  
Lower Control Arm Bush

**LR2122**  
Lower Control Arm Bush



**LR2025**  
Lower Control Arm  
Oem Ref: LR034218

**LR2026**  
Lower Control Arm  
Oem Ref: LR034217

**LR2812**  
Stabilizer Bar Bush



**RANGE ROVER REAR**

**LR1525 / LR1526**  
Link Stabilizer  
L=184



**LR1527 LR1528**  
Link Stabilizer  
L=190.5



**LR2923**  
Bush

**LR2923**  
Bush

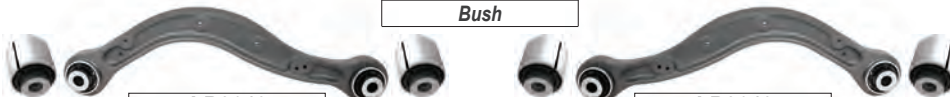

**LR2923**  
Bush

**LR2618**  
Lateral Link

**LR2618**  
Lateral Link

**LR2924**  
Bush



**LEFT**

**RIGHT**



**MAHINDRA**

**BOLERO**

**FRONT**

**ALL MODELS**

*Year*

**2003-**

**MH1010**  
Outer Tie Rod End  
(Ø14.2\*Ø16/M18\*1.5)(M/S)



**MH1310**  
Outer Tie Rod End Set  
(Ø14.2\*Ø16/M18\*1.5)(M/S)

**MH1010**  
Outer Tie Rod End  
(Ø14.2\*Ø16/M18\*1.5)(M/S)



**MH1311**  
Outer Tie Rod End Set  
(Ø14\*Ø16.5/M14\*1.5)(P/S)

**MH1011**  
Outer Tie Rod End  
(Ø14\*Ø16.5/M14\*1.5)(P/S)



**MH1413**  
Rack End  
(14\*1.5/14\*1.5/291)



**MH1011**  
Outer Tie Rod End  
(Ø14\*Ø16.5/M14\*1.5)(P/S)



**MH1510 / MH1511**  
Link Stabilizer  
L=156



**MH1614**  
Upper Ball Joint  
(Ø16.4)



**MH1614**  
Upper Ball Joint  
(Ø16.4)



**MH1910**  
Lower Ball Joint  
(---)



**MH1910**  
Lower Ball Joint  
(---)



**LEFT**

**RIGHT**

**MAHINDRA**

**SCORPIO**

**FRONT**

**ALL MODELS**

*Year*

**2003-**

**MH1012**  
Outer Tie Rod End  
(Ø13.5\*Ø14/M12\*1.25)

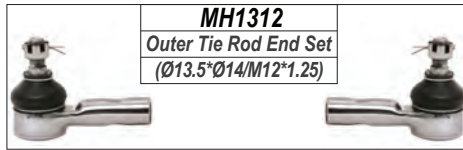

**MH1312**  
Outer Tie Rod End Set  
(Ø13.5\*Ø14/M12\*1.25)

**MH1410**  
Rack End  
(14\*1.5/14\*1.5/294)

**MH1012**  
Outer Tie Rod End  
(Ø13.5\*Ø14/M12\*1.25)



**MH1510 / MH1511**  
Link Stabilizer  
L=156



**MH1514**  
Link Stabilizer  
L=171



**MH1615**  
Upper Ball Joint  
(Ø17.7)



**MH1615**  
Upper Ball Joint  
(Ø17.7)



**MH1911**  
Lower Ball Joint  
(Ø17.6)



**MH1911**  
Lower Ball Joint  
(Ø17.6)



**LEFT**

**RIGHT**

**MAHINDRA**

**XUV500**

**FRONT**

**ALL MODELS**

*Year*

**2011-**

**MH1314**  
Outer Tie Rod End Set  
(Ø15\*Ø15/M14\*1.50)



**MH1014**  
Outer Tie Rod End  
(Ø15\*Ø15/M14\*1.50)



**MH1412**  
Rack End  
(14\*1.5/14\*1.5/178)



**MH1015**  
Outer Tie Rod End  
(Ø15\*Ø15/M14\*1.50)



**MH1515 / MH1516**  
Link Stabilizer  
L=285



**MH1913**  
Lower Ball Joint  
(Ø22)



**MH1913**  
Lower Ball Joint  
(Ø22)



**LEFT**

**RIGHT**

**MAHINDRA**

**XYLO**

**FRONT**

**ALL MODELS**

**Year**

**2010-**

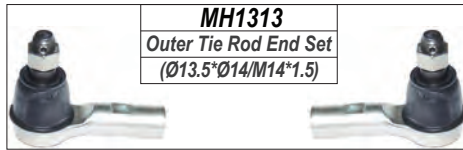

**MH1313**  
Outer Tie Rod End Set  
(Ø13.5\*Ø14/M14\*1.5)

**MH1013**  
Outer Tie Rod End  
(Ø13.5\*Ø14/M14\*1.5)



**MH1411**  
Rack End  
(16\*1.5/14\*1.5/275)

**MH1013**  
Outer Tie Rod End  
(Ø13.5\*Ø14/M14\*1.5)

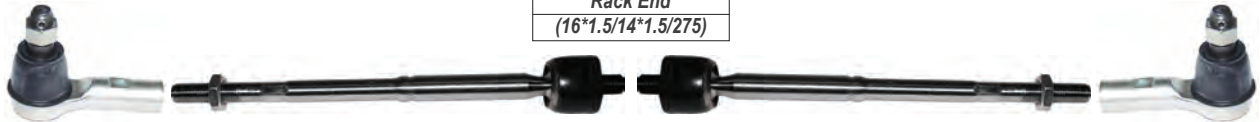

**MH1512 / MH1513**  
Link Stabilizer  
L=118



**MH1710**  
Upper Control Arm

**MH1710**  
Upper Control Arm

**MH1912**  
Lower Ball Joint  
(Ø17.6)



**MH1912**  
Lower Ball Joint  
(Ø17.6)



**LEFT**

**RIGHT**

**MAZDA**

121

**FRONT**

**ALL MODELS**

Year

1997-2004

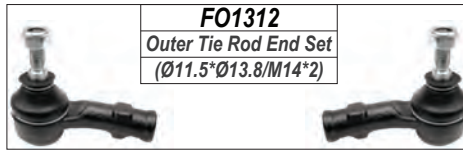

**FO1312**  
Outer Tie Rod End Set  
(Ø11.5\*Ø13.8/M14\*2)

**FO1027**  
Outer Tie Rod End  
(Ø11.5\*Ø13.8/M14\*2)



**FO1423**  
Rack End  
(14\*1.5/14\*2.0/306)

**FO1028**  
Outer Tie Rod End  
(Ø11.5\*Ø13.8/M14\*2)



**FO1510**  
Link Stabilizer  
L=239



**FO2113**  
Lower Control Arm Bush

**FO1913**  
Lower Ball Joint  
(Ø16.5)



**FO1913**  
Lower Ball Joint  
(Ø16.5)



**FO2028**  
Lower Control Arm



**FO2029**  
Lower Control Arm

**FO2818**  
Shock Mounting



**FO2114**  
Lower Control Arm Bush

**FO2818**  
Shock Mounting



121

**REAR**

**MA1510**  
Link Stabilizer  
L=80



**LEFT**

**RIGHT**



**MAZDA**

2

**FRONT**

**ALL MODELS**

Year

2007-2009

**FO1035**  
Outer Tie Rod End  
(Ø11.55\*Ø13.8/M14\*1.5)

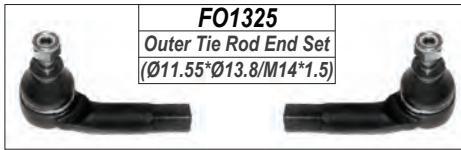

**FO1325**  
Outer Tie Rod End Set  
(Ø11.55\*Ø13.8/M14\*1.5)

**FO1435**  
Rack End  
(14\*1.5/14\*1.5/277)

**FO1036**  
Outer Tie Rod End  
(Ø11.55\*Ø13.8/M14\*1.5)



**FO1037**  
Outer Tie Rod End  
(Ø12.8\*Ø15.6/M14\*1.5)



**FO1326**  
Outer Tie Rod End Set  
(Ø12.8\*Ø15.6/M14\*1.5)

**FO1427**  
Rack End  
(14\*1.5/14\*1.5/213)

**FO1038**  
Outer Tie Rod End  
(Ø12.8\*Ø15.6/M14\*1.5)

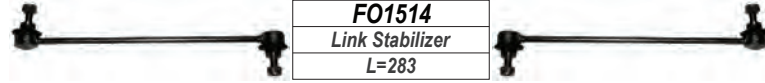

**FO1514**  
Link Stabilizer  
L=283

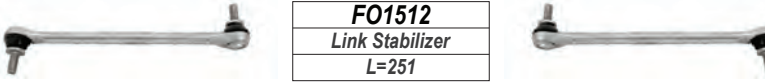

**FO1512**  
Link Stabilizer  
L=251

**FO1918**  
Lower Ball Joint  
(Ø16.5)



**FO2032**  
Lower Control Arm

**FO2033**  
Lower Control Arm

**FO2119**  
Lower Control Arm Bush

**FO1918**  
Lower Ball Joint  
(Ø16.5)



**FO2819**  
Shock Mounting



**FO2819**  
Shock Mounting



**FO2120**  
Lower Control Arm Bush



2

**REAR**

**FO2820**  
Shock Mounting



**FO2820**  
Shock Mounting



**LEFT**

**RIGHT**

**MAZDA**

2

**FRONT**

**ALL MODELS**

Year

**2009-2015**

**FO1010**  
Outer Tie Rod End  
(Ø12.9\*Ø15.65/M14\*1.5)

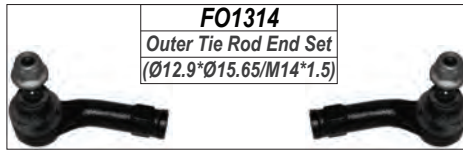

**FO1314**  
Outer Tie Rod End Set  
(Ø12.9\*Ø15.65/M14\*1.5)

**FO1411**  
Rack End  
(14\*1.5/14\*1.5/295)

**FO1011**  
Outer Tie Rod End  
(Ø12.9\*Ø15.65/M14\*1.5)



**FO1326**  
Outer Tie Rod End Set  
(Ø12.8\*Ø15.6/M14\*1.5)

**FO1037**  
Outer Tie Rod End  
(Ø12.8\*Ø15.6/M14\*1.5)



**FO1427**  
Rack End  
(14\*1.5/14\*1.5/213)

**FO1038**  
Outer Tie Rod End  
(Ø12.8\*Ø15.6/M14\*1.5)

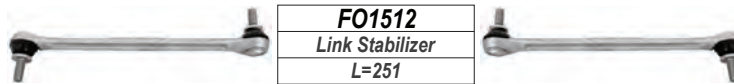

**FO1512**  
Link Stabilizer  
L=251

**FO2121**  
Lower Control Arm Bush

**FO1910**  
Lower Ball Joint  
(Ø17.5)



**FO2034**  
Lower Control Arm

**FO2035**  
Lower Control Arm

**FO1910**  
Lower Ball Joint  
(Ø17.5)



**FO2819**  
Shock Mounting



**FO2122**  
Lower Control Arm Bush



**FO2819**  
Shock Mounting



2

**REAR**

**FO2820**  
Shock Mounting



**FO2820**  
Shock Mounting



**LEFT**

**RIGHT**

**MAZDA**

2

**FRONT**

**ALL MODELS**

Year

2014-

**MA1029**  
Outer Tie Rod End  
(Ø12.65\*Ø15.5/M14\*1.5)



**MA1323**  
Outer Tie Rod End Set  
(Ø12.65\*Ø15.5/M14\*1.5)

**MA1424**  
Rack End  
(14\*1.5/16\*1.5/244)



**MA1030**  
Outer Tie Rod End  
(Ø12.65\*Ø15.5/M14\*1.5)



**MA1530**  
Link Stabilizer  
L=251



**FO1910**  
Lower Ball Joint  
(Ø17.5)



**MA2130**  
Lower Control Arm Bush



**FO1910**  
Lower Ball Joint  
(Ø17.5)



**MA2037**  
Lower Control Arm



**MA2038**  
Lower Control Arm



**MA2131**  
Lower Control Arm Bush



**FO2819**  
Shock Mounting



**FO2819**  
Shock Mounting



**LEFT**

**RIGHT**

**MAZDA**

3

**FRONT**

**ALL MODELS**

Year

2004-2009V

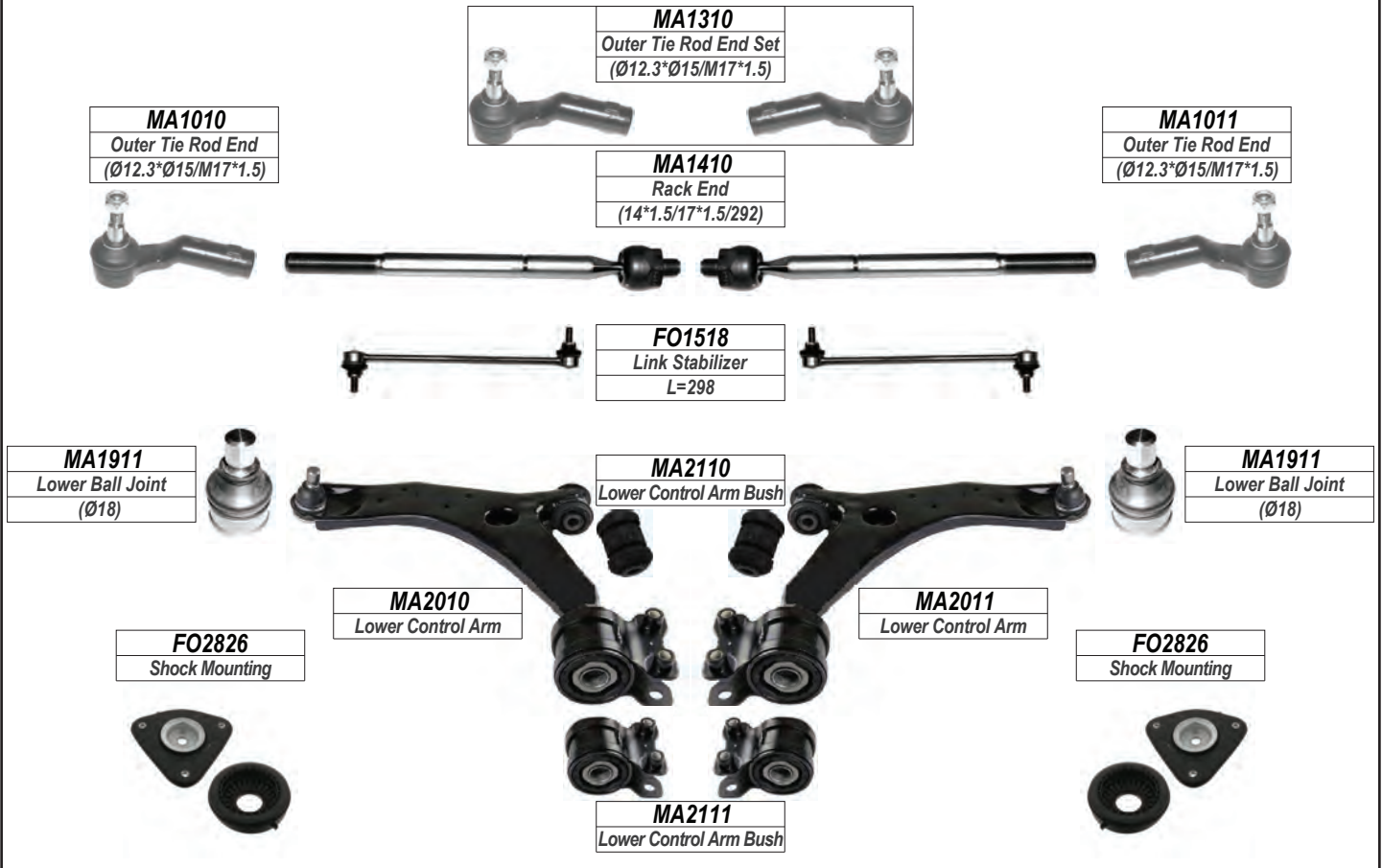

3

**REAR**

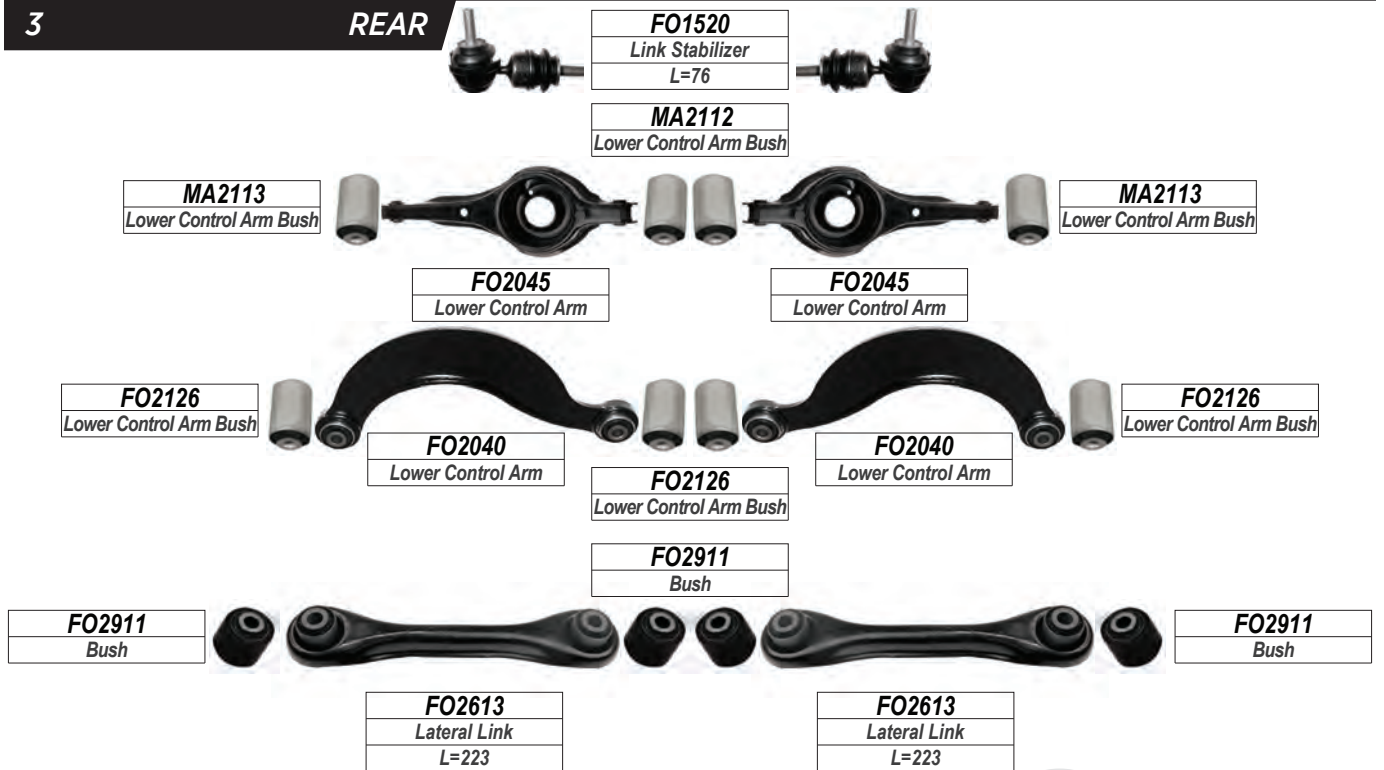

**LEFT**

**RIGHT**



**MAZDA**

3

**FRONT**

**ALL MODELS**

Year

2009-2014

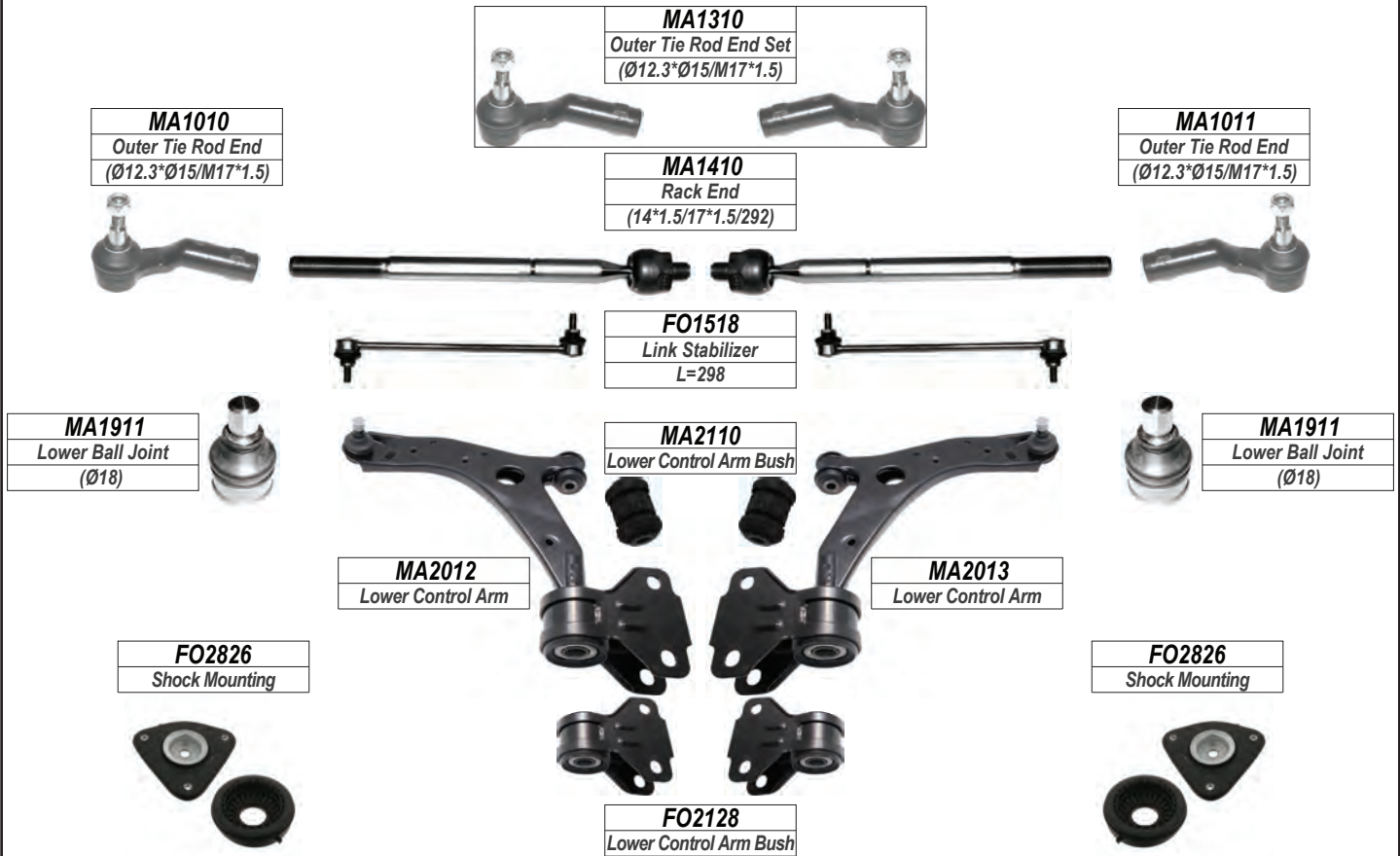

3

**REAR**

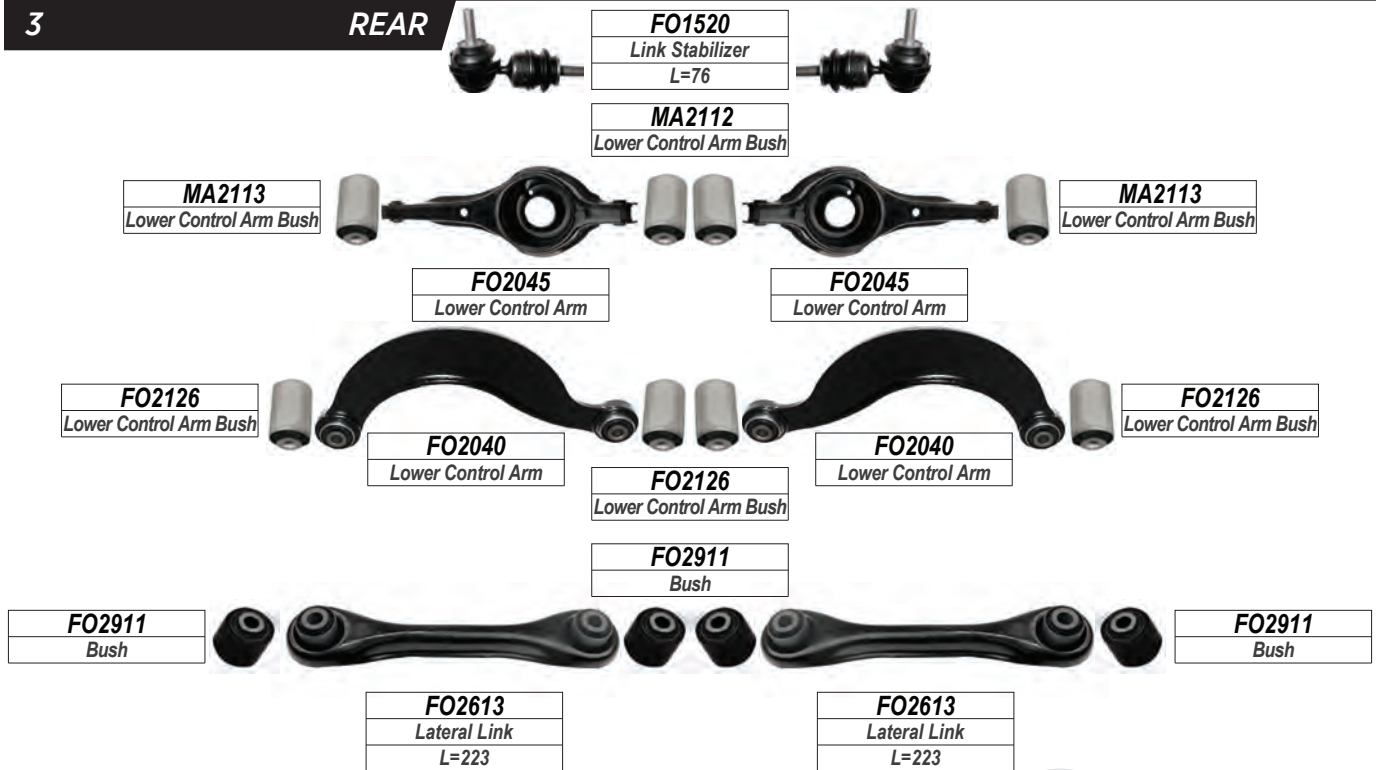

**LEFT**

**RIGHT**



**MAZDA**

3

**FRONT**

**ALL MODELS**

Year

2014-

**MA1012**  
Outer Tie Rod End  
(Ø12.65\*Ø15.5/M14\*1.5)

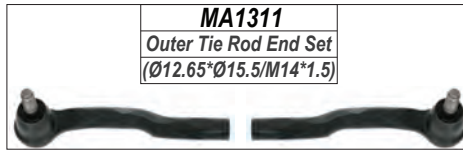

**MA1311**  
Outer Tie Rod End Set  
(Ø12.65\*Ø15.5/M14\*1.5)

**MA1411**  
Rack End  
(14\*1.5/14\*1.5/219)



**MA1013**  
Outer Tie Rod End  
(Ø12.65\*Ø15.5/M14\*1.5)



**MA1511 / MA1512**  
Link Stabilizer  
L=284



**MA2114**  
Lower Control Arm Bush

Lower Control Arm Bush

**MA2115 / MA2116**  
Lower Control Arm Bush

Lower Control Arm Bush

**MA1910**  
Lower Ball Joint  
(Ø20)



**MA1910**  
Lower Ball Joint  
(Ø20)

**MA2014**  
Lower Control Arm

Lower Control Arm

**MA2015**  
Lower Control Arm

Lower Control Arm

**LEFT**

**RIGHT**

**MAZDA**

**323**

**FRONT**

**ALL MODELS**

*Year*

**1981-1986**

<b>MA1014</b>
Outer Tie Rod End
(Ø12.7*Ø14.2/M12*1.25)

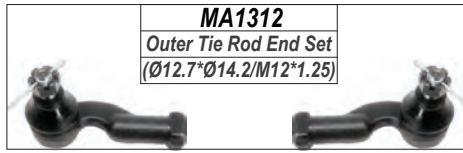

<b>FO1410</b>
Rack End
(14*1.5/12*1.25/305)



<b>MA1015</b>
Outer Tie Rod End
(Ø12.7*Ø14.2/M12*1.25)



<b>FO1912</b>
Lower Ball Joint
(Ø16)



<b>FO1912</b>
Lower Ball Joint
(Ø16)

**LEFT**

**RIGHT**

**MAZDA**

323

FRONT

MIDGE.SEDAN.STING

Year

1986-2004

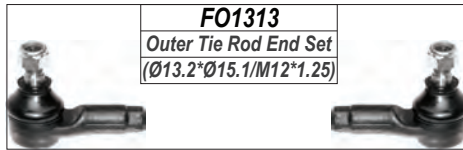

**F01313**  
Outer Tie Rod End Set  
(Ø13.2\*Ø15.1/M12\*1.25)

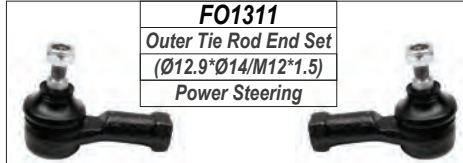

**F01311**  
Outer Tie Rod End Set  
(Ø12.9\*Ø14/M12\*1.5)  
Power Steering

**F01029**  
Outer Tie Rod End  
(Ø13.2\*Ø15.1/M12\*1.25)



**F01029**  
Outer Tie Rod End  
(Ø13.2\*Ø15.1/M12\*1.25)



**F01422**  
Rack End (PS)  
(17\*1.0/12\*1.25/306)



**F01026**  
Outer Tie Rod End  
(Ø12.9\*Ø14/M12\*1.25)



**F01410**  
Rack End (MS)  
(14\*1.5/12\*1.25/305)



**F01026**  
Outer Tie Rod End  
(Ø12.9\*Ø14/M12\*1.25)



**F02145**  
Lower Control Arm Bush



**F01912**  
Lower Ball Joint  
(Ø16)



**F01912**  
Lower Ball Joint  
(Ø16)



**F02014**  
Lower Control Arm

**F02015**  
Lower Control Arm

**F02112**  
Lower Control Arm Bush



**F02817**  
Shock Mounting



**F02817**  
Shock Mounting



**F02827**  
Shock Mounting



**F02827**  
Shock Mounting



LEFT

RIGHT

**MAZDA**

5

**FRONT**

**ALL MODELS**

Year

2007-

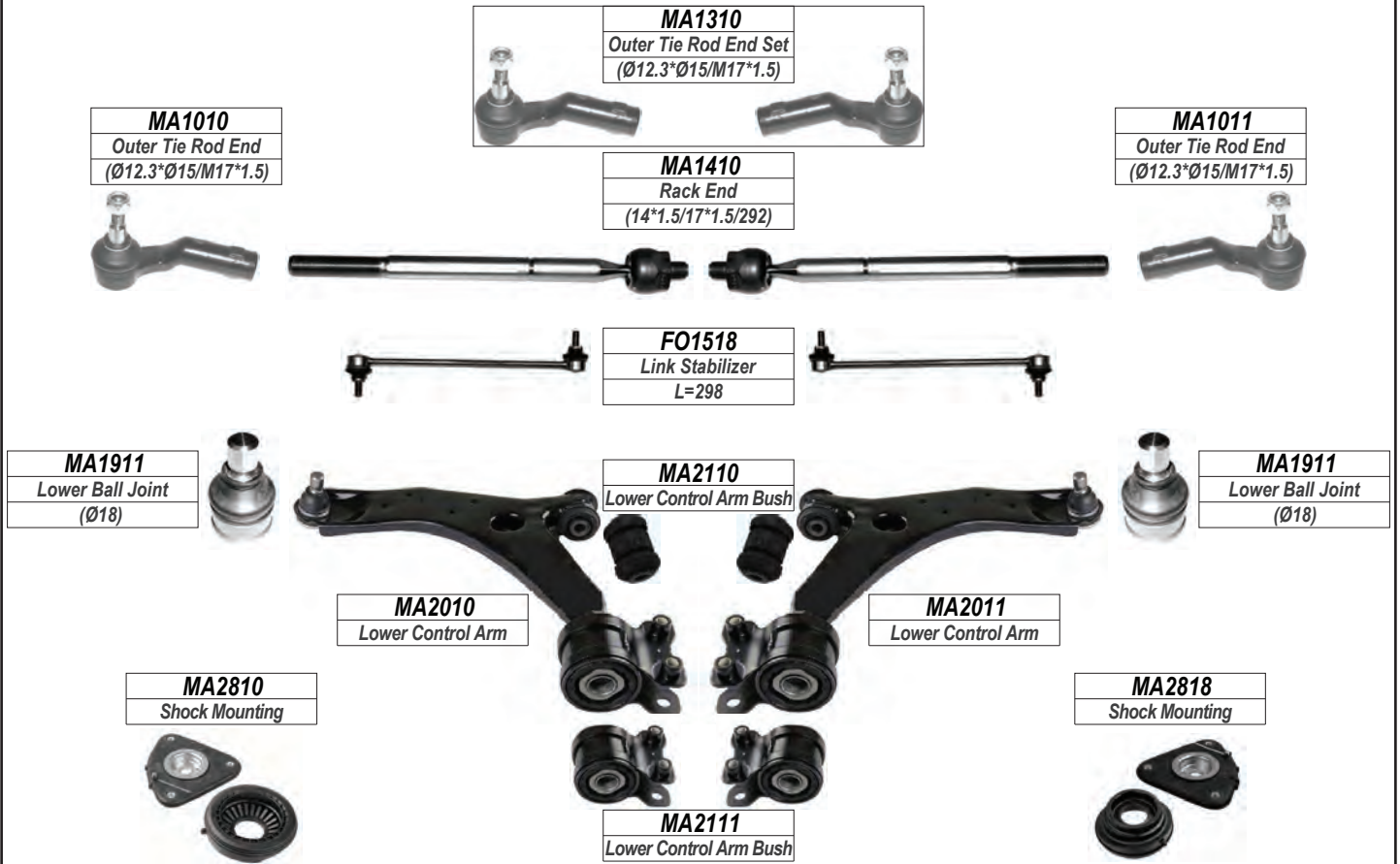

3

**REAR**

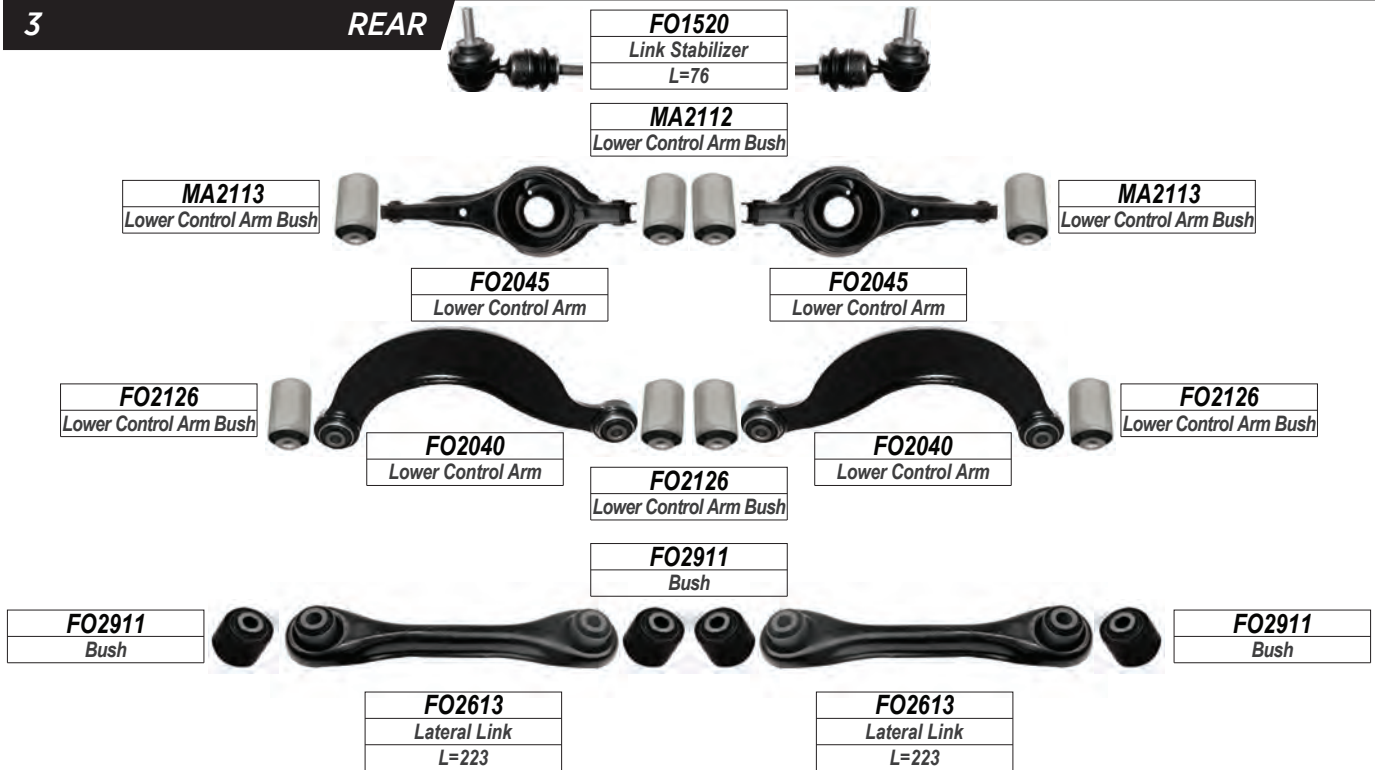

**LEFT**

**RIGHT**

**MAZDA**

6

**FRONT**

**ALL MODELS**

Year

2003-2007

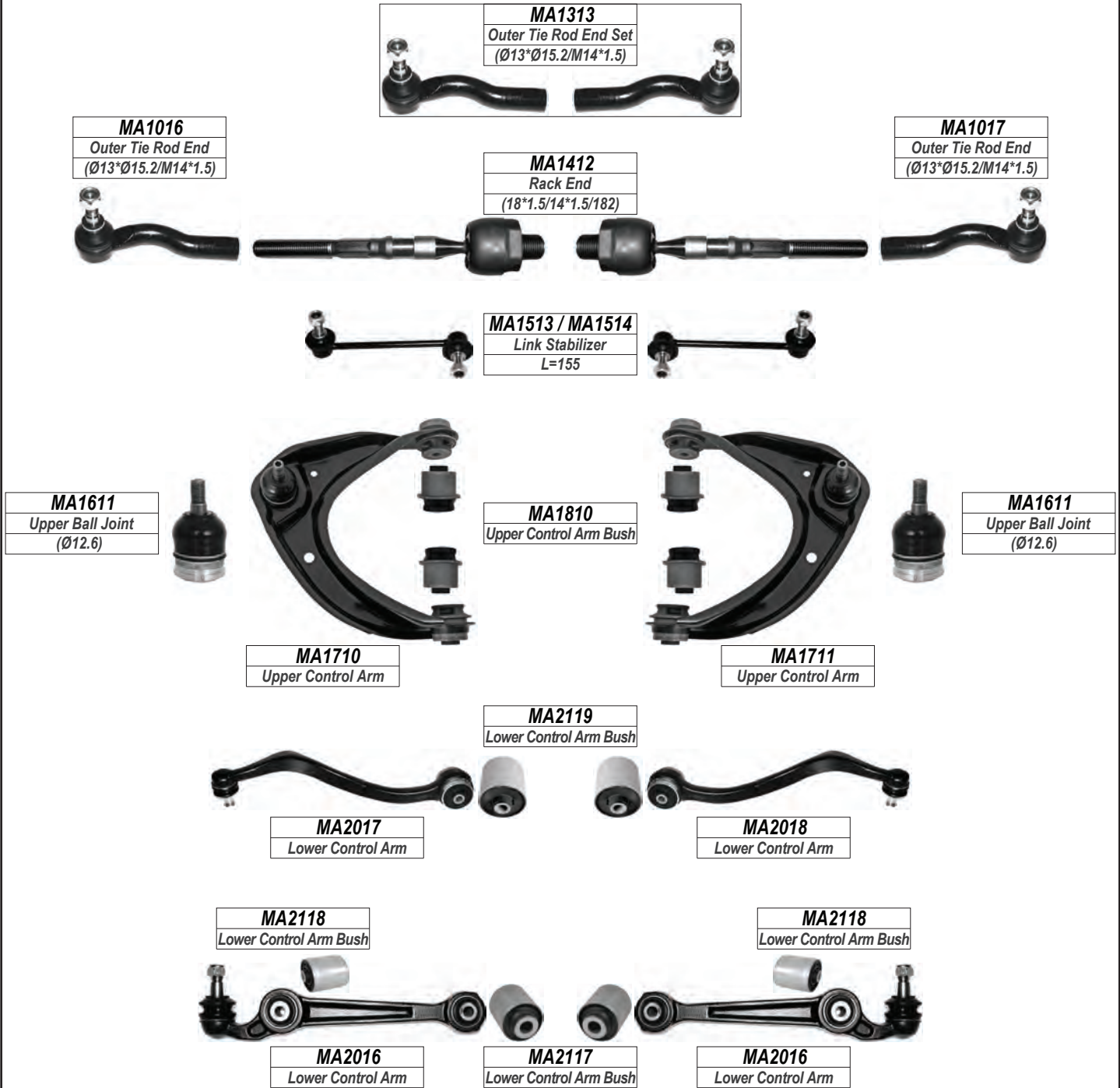

6

**REAR**

**MA1515**  
Link Stabilizer  
L=77



**LEFT**

**RIGHT**



**MAZDA**

6

**FRONT**

**ALL MODELS**

Year

**2008-2013**

**MA1314**  
Outer Tie Rod End Set  
(Ø12.66\*Ø15/M14\*1.5)



**MA1024**  
Outer Tie Rod End  
(Ø12.66\*Ø15/M14\*1.5)



**MA1422**  
Rack End  
(18\*1.5/14\*1.5/165)



**MA1025**  
Outer Tie Rod End  
(Ø12.66\*Ø15/M14\*1.5)



**MA1516 / MA1517**  
Link Stabilizer  
L=159.5



**MA1611**  
Upper Ball Joint  
(Ø12.6)



**MA1712**  
Upper Control Arm

**MA1810**  
Upper Control Arm Bush



**MA1713**  
Upper Control Arm

**MA1611**  
Upper Ball Joint  
(Ø12.6)



**MA2121**  
Lower Control Arm Bush



**MA2120**  
Lower Control Arm Bush



**MA2121**  
Lower Control Arm Bush



**MA2019**  
Lower Control Arm



**MA2020**  
Lower Control Arm



**MA2122 / MA2123**  
Lower Control Arm Bush



**LEFT**

**RIGHT**

**MAZDA**

6

**FRONT**

**ALL MODELS**

Year

2014-

**MA1026**  
Outer Tie Rod End  
(Ø12.65\*Ø15.5/M14\*1.5)



**MA1315**  
Outer Tie Rod End Set  
(Ø12.65\*Ø15.5/M14\*1.5)

**MA1413**  
Rack End  
(20\*1.5/14\*1.5/178)



**MA1027**  
Outer Tie Rod End  
(Ø12.65\*Ø15.5/M14\*1.5)



**MA1513 / MA1514**  
Link Stabilizer  
L=155



**MA2114**  
Lower Control Arm Bush

**MA1910**  
Lower Ball Joint  
(Ø20)

**MA1910**  
Lower Ball Joint  
(Ø20)



**MA2025**  
Lower Control Arm

**MA2026**  
Lower Control Arm

**MA1910**  
Lower Ball Joint  
(Ø20)



**MA2124 / MA2125**  
Lower Control Arm Bush



6

**REAR**

**MA1518**  
Link Stabilizer  
L=95



**LEFT**

**RIGHT**

**MAZDA**

626

FRONT

ALL MODELS

Year

1983-1993

**MA1018**  
Outer Tie Rod End  
(Ø13.7\*Ø15.1/M14\*1.5)

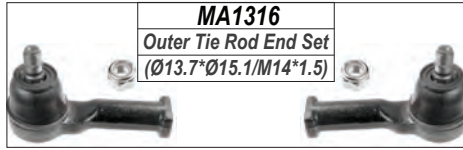

**MA1316**  
Outer Tie Rod End Set  
(Ø13.7\*Ø15.1/M14\*1.5)

**MA1018**  
Outer Tie Rod End  
(Ø13.7\*Ø15.1/M14\*1.5)



**MA1414**  
Rack End  
(16\*1/14\*1.5/283)



**MA1415**  
Rack End  
(18\*1.5/14\*1.5/280)



**MA1416**  
Rack End  
(18\*1.5/14\*1.5/300)



**MA2021**  
Lower Control Arm



**MA2022**  
Lower Control Arm

**FO1932**  
Lower Ball Joint  
(Ø18)



**FO1932**  
Lower Ball Joint  
(Ø18)



**MA2811**  
Shock Mounting(Manual)



**MA2811**  
Shock Mounting(Manual)



**MA2812**  
Shock Mounting(Auto)



**MA2812**  
Shock Mounting(Auto)



LEFT

RIGHT

**MAZDA**

626

FRONT

ALL MODELS

Year

1993-2003

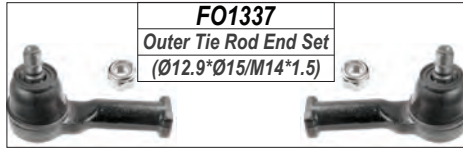

**FO1337**  
Outer Tie Rod End Set  
(Ø12.9\*Ø15/M14\*1.5)

**FO1021**  
Outer Tie Rod End  
(Ø12.9\*Ø15/M14\*1.5)



**MA1416**  
Rack End  
(18\*1.5/14\*1.5/300)



**FO1021**  
Outer Tie Rod End  
(Ø12.9\*Ø15/M14\*1.5)



**MA1418**  
Rack End  
(18\*1.5/14\*1.5/307)



**FO1537 / FO1538**  
Link Stabilizer  
L=104.5

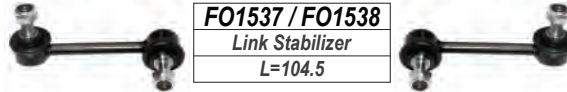

**FO1932**  
Lower Ball Joint  
(Ø18)



**FO2070**  
Lower Control Arm

**FO2071**  
Lower Control Arm

**FO1932**  
Lower Ball Joint  
(Ø18)



**MA2813**  
Shock Mounting



**MA2033**  
Lower Control Arm



**MA2034**  
Lower Control Arm

**MA2813**  
Shock Mounting



**MA2814**  
Shock Mounting



**MA2814**  
Shock Mounting



626

REAR

**MA2815**  
Shock Mounting



**FO1539**  
Link Stabilizer  
L=88

**MA1519**  
Link Stabilizer  
L=230



**MA2816**  
Shock Mounting



LEFT

RIGHT

**MAZDA**

**ASTINA**

**FRONT**

**ALL MODELS**

*Year*

**1995-2000**

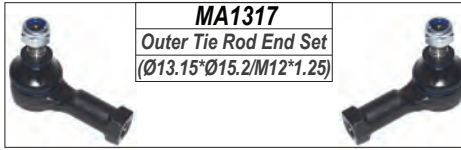

**MA1019**  
Outer Tie Rod End  
(Ø13.15\*Ø15.2/M12\*1.25)



**MA1417**  
Rack End  
(16\*1.0/12\*1.25/335)



**MA1019**  
Outer Tie Rod End  
(Ø13.15\*Ø15.2/M12\*1.25)



**FO1537 / FO1538**  
Link Stabilizer  
L=104,5



**MA1912**  
Lower Ball Joint  
(Ø18)



**MA2023**  
Lower Control Arm

**MA2024**  
Lower Control Arm

**MA1912**  
Lower Ball Joint  
(Ø18)



**MA2814**  
Shock Mounting



**MA2814**  
Shock Mounting



**LEFT**

**RIGHT**



**MAZDA**

**B SERIES**

**FRONT**

**ALL MODELSS**

*Year*

**1982-1986**

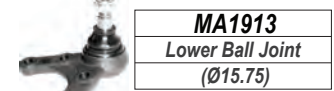
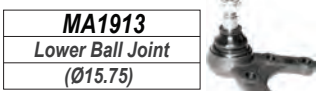
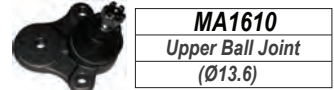
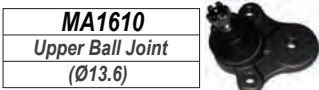
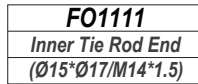
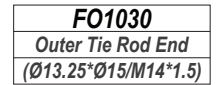
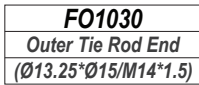
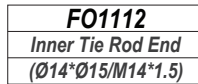
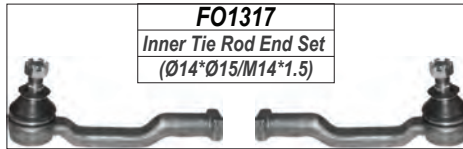
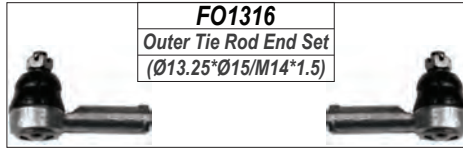

**LEFT**

**RIGHT**

**MAZDA**

**B SERIES**

**FRONT**

**2WD**

*Year*

**1986-2000**

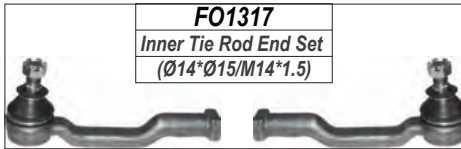
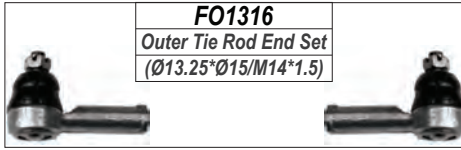

**FO1112**  
Inner Tie Rod End  
(Ø14\*Ø15/M14\*1.5)



**FO1030**  
Outer Tie Rod End  
(Ø13.25\*Ø15/M14\*1.5)



**FO1111**  
Inner Tie Rod End  
(Ø15\*Ø17/M14\*1.5)



**FO1030**  
Outer Tie Rod End  
(Ø13.25\*Ø15/M14\*1.5)



**FO1611**  
Upper Ball Joint  
(Ø13.6)



**FO1710**  
Upper Control Arm

**FO1711**  
Upper Control Arm

**FO1611**  
Upper Ball Joint  
(Ø13.6)



**FO1914**  
Lower Ball Joint  
STD Body(Ø17.8)



**FO2020**  
Lower Control Arm

**CA2110**  
Lower Control Arm Bush

**FO2021**  
Lower Control Arm

**FO1914**  
Lower Ball Joint  
STD Body(Ø17.8)



**FO2410**  
Idler Arm



**FO2512**  
Pitman Arm  
Splines : 27mm



**FO2513**  
Pitman Arm  
Splines : 25mm



**LEFT**

**RIGHT**

**MAZDA**

**B SERIES**

**FRONT**

**4WD**

*Year*

**1986-2000**

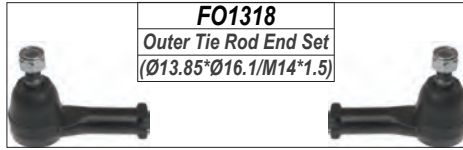

**FO1318**  
Outer Tie Rod End Set  
(Ø13.85\*Ø16.1/M14\*1.5)



**MA1318**  
Inner Tie Rod End Set  
(Ø13.54\*Ø15.6/M14\*1.5)

**FO1031**  
Outer Tie Rod End  
(Ø13.85\*Ø16.1/M14\*1.5)



**MA1110**  
Inner Tie Rod End  
(Ø13.54\*Ø15.6/M14\*1.5)



**FO1031**  
Outer Tie Rod End  
(Ø13.85\*Ø16.1/M14\*1.5)



**FO1810**  
Upper Control Arm Bush



**FO1611**  
Upper Ball Joint  
(Ø13.6)



**FO1611**  
Upper Ball Joint  
(Ø13.6)

**FO1712**  
Upper Control Arm

**FO1713**  
Upper Control Arm

**FO2115**  
Lower Control Arm Bush



**FO1915**  
Lower Ball Joint  
(Ø17.75)



**FO1915**  
Lower Ball Joint  
(Ø17.75)



**FO2022**  
Lower Control Arm

**CA2110**  
Lower Control Arm Bush



**FO2023**  
Lower Control Arm



**FO2410**  
Idle Arm



**FO2512**  
Pitman Arm  
Spline : 27mm

**LEFT**

**RIGHT**

**MAZDA**

**B SERIES**

**FRONT**

**ALL MODELS**

*Year*

**2000-2007**

**FO1030**  
Outer Tie Rod End  
(Ø13.25\*Ø15/M14\*1.5)

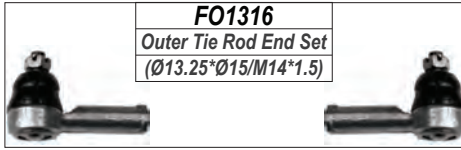

**FO1316**  
Outer Tie Rod End Set  
(Ø13.25\*Ø15/M14\*1.5)



**FO1315**  
Inner Tie Rod End Set  
(Ø15\*Ø17/M14\*1.5)

**FO1111**  
Inner Tie Rod End  
(Ø15\*Ø17/M14\*1.5)



**FO1030**  
Outer Tie Rod End  
(Ø13.25\*Ø15/M14\*1.5)

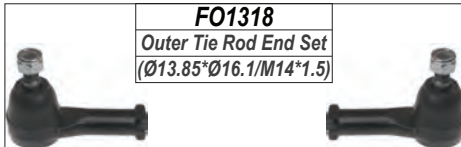

**FO1318**  
Outer Tie Rod End Set  
(Ø13.85\*Ø16.1/M14\*1.5)



**MA1318**  
Inner Tie Rod End Set  
(Ø13.54\*Ø15.6/M14\*1.5)

**MA1110**  
Inner Tie Rod End  
(Ø13.54\*Ø15.6/M14\*1.5)



**FO1031**  
Outer Tie Rod End  
(Ø13.85\*Ø16.1/M14\*1.5)



**FO1031**  
Outer Tie Rod End  
(Ø13.85\*Ø16.1/M14\*1.5)

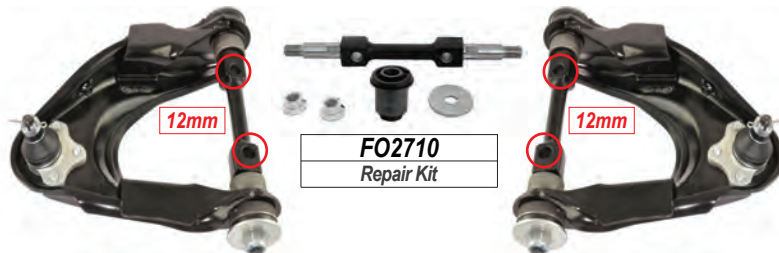

**FO2710**  
Repair Kit



**FO1712**  
Upper Control Arm  
Hi-Ride



**FO1713**  
Upper Control Arm  
Hi-Ride



**FO1722**  
Upper Control Arm



**FO1723**  
Upper Control Arm

**FO1611**  
Upper Ball Joint  
(Ø13.6)



**FO1611**  
Upper Ball Joint  
(Ø13.6)



**LEFT**

**RIGHT**



**MAZDA**

**B SERIES**

**FRONT**

**ALL MODELS**

*Year*

**2000-2007**



**FO1811**  
Upper Control Arm Bush

**FO1714**  
Upper Control Arm

**FO1715**  
Upper Control Arm



**FO1914**  
Lower Ball Joint  
(Ø17.8)

**FO2020**  
Lower Control Arm

**CA2110**  
Lower Control Arm Bush

**FO2021**  
Lower Control Arm

**FO1914**  
Lower Ball Joint  
(Ø17.8)



**FO2115**  
Lower Control Arm Bush

**FO1915**  
Lower Ball Joint  
Hi Ride(Ø17.75)

**FO2022**  
Lower Control Arm  
Hi Ride

**CA2110**  
Lower Control Arm Bush

**FO2023**  
Lower Control Arm  
Hi Ride

**FO1915**  
Lower Ball Joint  
Hi Ride(Ø17.75)

**FO2411**  
Idler Arm



**FO2512**  
Pitman Arm  
Spline : 27mm / (Ø10)



**FO2511**  
Pitman Arm  
(Ø14.3)



**FO2514**  
Pitman Arm  
(Ø15.3)



**LEFT**

**RIGHT**



**MAZDA**

BT-50

FRONT

ALL MODELS

Year

2006-2012

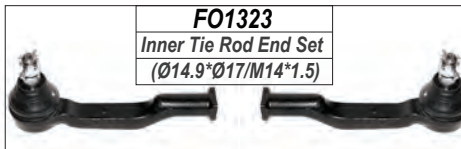
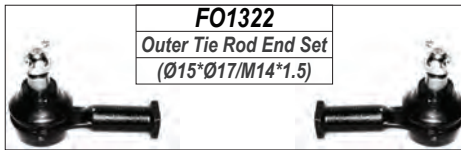

**FO1014**  
Outer Tie Rod End  
(Ø15\*Ø17/M14\*1.5)



**FO1110**  
Inner Tie Rod End  
(Ø14.9\*Ø17/M14\*1.5)



**FO1014**  
Outer Tie Rod End  
(Ø15\*Ø17/M14\*1.5)



**FO1611**  
Upper Ball Joint  
(Ø13.6)



**FO1611**  
Upper Ball Joint  
(Ø13.6)



**FO1611**  
Upper Ball Joint  
(Ø13.6)



**FO1611**  
Upper Ball Joint  
(Ø13.6)



LEFT

RIGHT

**MAZDA**

**BT-50**

**FRONT**

**ALL MODELS**

*Year*

**2006-2012**

**F01915**  
Lower Ball Joint  
(Ø17.75)



**F02115**  
Lower Control Arm Bush



**F01915**  
Lower Ball Joint  
(Ø17.75)



**F01917**  
Lower Ball Joint  
(Ø19.5)



**F02022**  
Lower Control Arm

**CA2110**  
Lower Control Arm Bush

**F02023**  
Lower Control Arm

**F01917**  
Lower Ball Joint  
(Ø19.5)



**F01929**  
Lower Ball Joint  
(Ø19.5)



**F02062**  
Lower Control Arm

**CA2110**  
Lower Control Arm Bush

**F02063**  
Lower Control Arm

**F01929**  
Lower Ball Joint  
(Ø19.5)



**F02411**  
Idler Arm  
10 mm Hole



**F02412**  
Idler Arm  
14 mm Hole



**F02413**  
Idler Arm  
14 mm Hole / Opp Bracket



**F02510**  
Pitman Arm



**LEFT**

**RIGHT**

**MAZDA**

**BT50**

**FRONT**

**ALL MODELS**

*Year*

**2011-**

**FO1333**  
Outer Tie Rod End Set  
(Ø14.3\*Ø17.5/M14\*1.5)

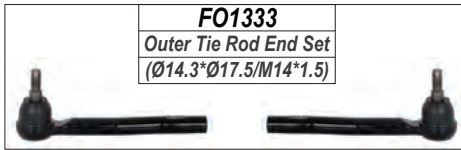

**FO1334**  
Outer Tie Rod End Set  
(Ø11.7\*Ø14.6/M12\*1.25)

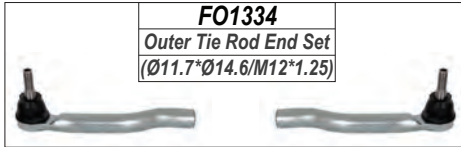

**FO1047**  
Outer Tie Rod End  
(Ø14.3\*Ø17.5/M14\*1.5)



**FO1415**  
Rack End  
(14\*1.5/14\*1.5/201)



**FO1048**  
Outer Tie Rod End  
(Ø14.3\*Ø17.5/M14\*1.5)



**FO1049**  
Outer Tie Rod End  
(Ø11.7\*Ø14.6/M12\*1.25)



**FO1050**  
Outer Tie Rod End  
(Ø11.7\*Ø14.6/M12\*1.25)



**FO1535 / FO1536**  
Link Stabilizer  
L=225.5



**FO1812**  
Upper Control Arm Bush



**FO1716**  
Upper Control Arm  
(Long)

**FO1717**  
Upper Control Arm  
(Long)

**FO1610**  
Upper Ball Joint  
(Ø18)



**FO1812**  
Upper Control Arm Bush



**FO1724**  
Upper Control Arm  
(Short)

**FO1725**  
Upper Control Arm  
(Short)

**FO1930**  
Lower Ball Joint  
(Ø21.35)



**FO1812**  
Lower Control Arm Bush



**FO2064**  
Lower Control Arm

**FO2065**  
Lower Control Arm

**LEFT**

**RIGHT**

**MAZDA**

**CX-3**

**FRONT**

**ALL MODELS**

**Year**

**2016-**

**MA1322**

Inner Tie Rod End Set  
(Ø12.7\*Ø15.5/M14\*1.5)

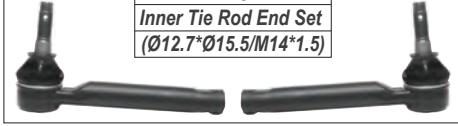

**MA1028**

Outer Tie Rod End  
(Ø12.7\*Ø15.5/M14\*1.5)



**MA1423**

Rack End  
(16\*1.5/14\*1.5/263)



**MA1028**

Outer Tie Rod End  
(Ø12.7\*Ø15.5/M14\*1.5)



**MA1529**

Link Stabilizer  
L=250



**MA2128**

Lower Control Arm Bush

**MA1910**

Lower Ball Joint  
(Ø20)



**MA1910**

Lower Ball Joint  
(Ø20)



**MA2035**

Lower Control Arm

**MA2036**

Lower Control Arm

**MA2129**

Lower Control Arm Bush



**LEFT**

**RIGHT**

**MAZDA**

**CX-5**

**FRONT**

**ALL MODELS**

**Year**

**2011-**

**MA1319**

Inner Tie Rod End Set  
(Ø12.65\*Ø15.5/M14\*1.5)

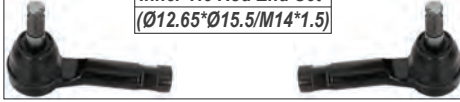

**MA1020**

Outer Tie Rod End  
(Ø12.65\*Ø15.5/M14\*1.5)



**MA1418**

Rack End  
(14\*1.5/14\*1.5/304)



**MA1020**

Outer Tie Rod End  
(Ø12.65\*Ø15.5/M14\*1.5)



**MA1520**

Link Stabilizer  
L=299



**MA2114**

Lower Control Arm Bush



**MA1910**

Lower Ball Joint  
(Ø20)



**MA1910**

Lower Ball Joint  
(Ø20)



**MA2025**

Lower Control Arm



**MA2026**

Lower Control Arm



**MA2124 / MA2125**

Lower Control Arm Bush



**CX-5**

**REAR**

**MA1521 / MA1522**

Link Stabilizer  
L=150



**LEFT**

**RIGHT**



**MAZDA**

**CX-7**

**FRONT**

**ALL MODELS**

*Year*

**2006-2012**

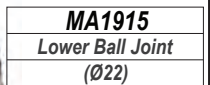
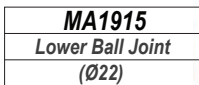
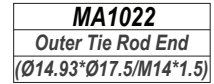
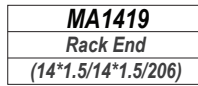
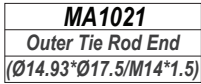

**LEFT**

**RIGHT**

**MAZDA**

**ETUDE**

**FRONT**

**ALL MODELS**

*Year*

**1995-2000**

**MA1019**  
Outer Tie Rod End  
(Ø13.15\*Ø15.2/M12\*1.25)

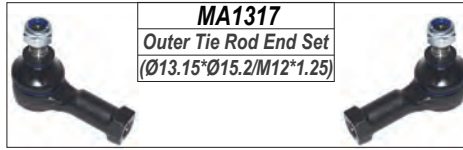

**MA1317**  
Outer Tie Rod End Set  
(Ø13.15\*Ø15.2/M12\*1.25)

**MA1417**  
Rack End  
(16\*1.0/12\*1.25/335)

**MA1019**  
Outer Tie Rod End  
(Ø13.15\*Ø15.2/M12\*1.25)



**FO1537 / FO1538**  
Link Stabilizer  
L=104,5



**DO1510**  
Link Stabilizer  
L=265



**MA1912**  
Lower Ball Joint  
(Ø18)



**MA2023**  
Lower Control Arm

**MA2024**  
Lower Control Arm

**MA1912**  
Lower Ball Joint  
(Ø18)



**LEFT**

**RIGHT**

**MAZDA**

ETUDE

FRONT

ALL MODELS

Year

1999-2004

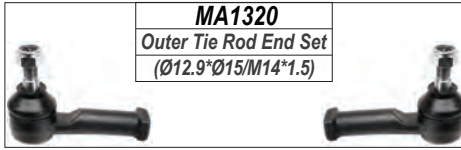

**MA1320**  
Outer Tie Rod End Set  
(Ø12.9\*Ø15/M14\*1.5)

**MA1021**  
Outer Tie Rod End  
(Ø12.9\*Ø15/M14\*1.5)

**MA1021**  
Outer Tie Rod End  
(Ø12.9\*Ø15/M14\*1.5)

**MA1420**  
Rack End  
(16\*1.0/14\*1.5/310)

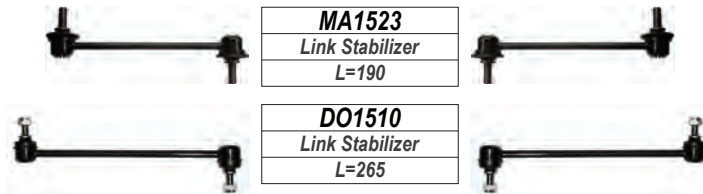

**MA1523**  
Link Stabilizer  
L=190

**DO1510**  
Link Stabilizer  
L=265

**MA2126**  
Lower Control Arm Bush



**MA2029**  
Lower Control Arm

**MA2030**  
Lower Control Arm

**FO1932**  
Lower Ball Joint  
(Ø18)



**FO1932**  
Lower Ball Joint  
(Ø18)



**MA2817**  
Shock Mounting



**MA2817**  
Shock Mounting



ETUDE

REAR

**MA1524**  
Link Stabilizer  
L=190



**MA1525**  
Link Stabilizer  
L=160



LEFT

RIGHT

**MAZDA**

**MARATHON**

**FRONT**

**ALL MODELS**

*Year*

**1991-2004**

**F01019**  
Outer Tie Rod End  
(Ø14\*Ø16/M14\*1.5)

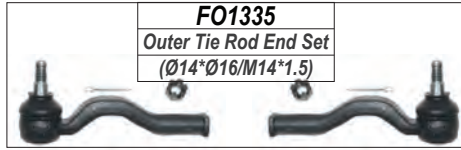

**F01335**  
Outer Tie Rod End Set  
(Ø14\*Ø16/M14\*1.5)

**F01417**  
Rack End  
(17\*1.0/14\*1.5/182)



**F01019**  
Outer Tie Rod End  
(Ø14\*Ø16/M14\*1.5)



**F01612**  
Upper Ball Joint  
(Ø17.85)



**F01718**  
Upper Control Arm



**F01719**  
Upper Control Arm



**F01612**  
Upper Ball Joint  
(Ø17.85)

**F01931**  
Lower Ball Joint  
(Ø19.75)



**F02068**  
Lower Control Arm

**F02069**  
Lower Control Arm



**F01931**  
Lower Ball Joint  
(Ø19.75)

**LEFT**

**RIGHT**

**MAZDA**

**MX5**

**FRONT**

**ALL MODELS**

*Year*

**2001-2005**

**MA1023**  
Outer Tie Rod End  
(Ø13\*Ø15/M12\*1.25)

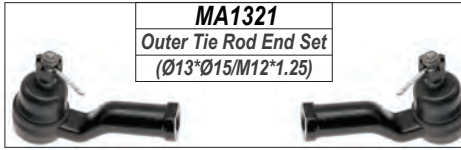

**MA1321**  
Outer Tie Rod End Set  
(Ø13\*Ø15/M12\*1.25)

**MA1421**  
Rack End  
(17\*1.5/12\*1.25/300)

**MA1023**  
Outer Tie Rod End  
(Ø13\*Ø15/M12\*1.25)

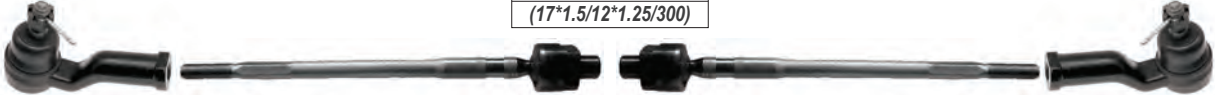

**MA1526**  
Link Stabilizer  
L=107



**MA1527 / MA1528**  
Link Stabilizer  
L=104



**MA1714**  
Upper Control Arm

**MA1715**  
Upper Control Arm

**MA1914**  
Lower Ball Joint  
(Ø15.75)



**MA2031**  
Lower Control Arm



**MA2032**  
Lower Control Arm



**MA1914**  
Lower Ball Joint  
(Ø15.75)

**LEFT**

**RIGHT**



**MAZDA**
**MX6**
**FRONT**
**ALL MODELS**

Year

1993-1998

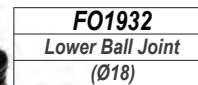
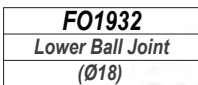
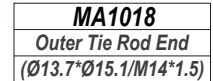
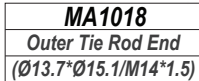
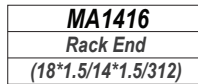
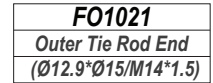
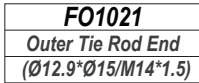
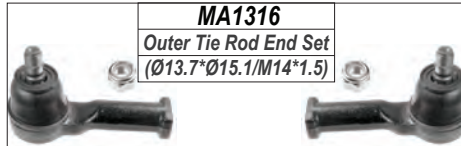
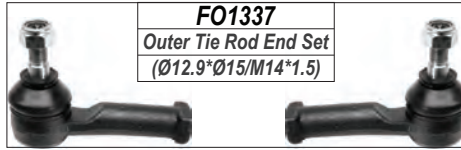
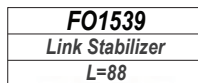
**MX6**
**REAR**

**LEFT**
**RIGHT**

**MAZDA**

**RUSTLER**

**FRONT**

**ALL MODELS**

*Year*

**1983-1994**

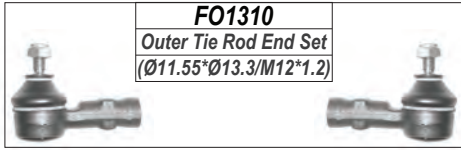

**FO1310**  
Outer Tie Rod End Set  
(Ø11.55\*Ø13.3/M12\*1.2)

**FO1025**  
Outer Tie Rod End  
(Ø11.55\*Ø13.3/M12\*1.2)

**FO1421**  
Rack End  
(14\*1.5/12\*20/290)

**FO1025**  
Outer Tie Rod End  
(Ø11.55\*Ø13.3/M12\*1.2)



**FO1510**  
Link Stabilizer  
L=239



**FO2110**  
Lower Control Arm Bush

**FO2111**  
Lower Control Arm Bush

**FO2110**  
Lower Control Arm Bush



**FO2010**  
Lower Control Arm  
1983-1986

**FO2011**  
Lower Control Arm  
1983-1986

**FO2110**  
Lower Control Arm Bush

**FO2111**  
Lower Control Arm Bush

**FO2110**  
Lower Control Arm Bush



**FO2012**  
Lower Control Arm  
1986-1994

**FO2013**  
Lower Control Arm  
1986-1994

**FO2810**  
Stabilizer Bar Bush



**FO2817**  
Shock Mounting

**FO2811**  
Stabilizer Bar Bush

**FO2817**  
Shock Mounting



**LEFT**

**RIGHT**

**MAZDA**

**RUSTLER**

**FRONT**

**ALL MODELS**

*Year*

**1994-2002**

**FO1029**  
Outer Tie Rod End  
(Ø13.2\*Ø15.1/M12\*1.25)

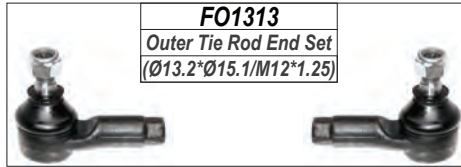

**FO1313**  
Outer Tie Rod End Set  
(Ø13.2\*Ø15.1/M12\*1.25)

**FO1029**  
Outer Tie Rod End  
(Ø13.2\*Ø15.1/M12\*1.25)



**FO1422**  
Rack End(P/S)  
(17\*1.0/12\*1.25/306)



**FO1410**  
Rack End(M/S)  
(14\*1.5/12\*1.5/305)



**FO1511**  
Link Stabilizer  
L=251



**FO2145**  
Lower Control Arm Bush

**FO1912**  
Lower Ball Joint  
(Ø16)



**FO2014**  
Lower Control Arm



**FO2015**  
Lower Control Arm

**FO1912**  
Lower Ball Joint  
(Ø16)



**FO2112**  
Lower Control Arm Bush



**LEFT**

**RIGHT**

**MERCEDES**

A209.C209 SERIES FRONT

CLK

Year

2002-2009

**ME1015**  
Outer Tie Rod End  
(Ø16.15\*Ø18.2/M14\*1.5)

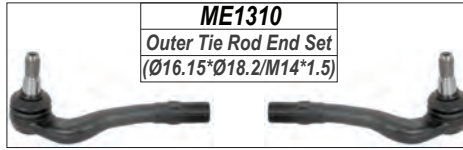

**ME1310**  
Outer Tie Rod End Set  
(Ø16.15\*Ø18.2/M14\*1.5)

**ME1016**  
Outer Tie Rod End  
(Ø16.15\*Ø18.2/M14\*1.5)



**ME1423**  
Rack End  
(16\*1.5/14\*1.5/239)



**ME1510**  
Link Stabilizer  
L=277



**ME2111**  
Lower Control Arm Bush



**ME2012**  
Upper Control Arm

**ME2013**  
Upper Control Arm

**ME2110**  
Lower Control Arm Bush



**ME2010**  
Lower Control Arm

**ME2011**  
Lower Control Arm

A209.C209 SERIES REAR



**ME2712**  
Repair Kit

**ME2910**  
Bush



**ME2610**  
Lateral Link  
L=245

**ME2610**  
Lateral Link  
L=245

**ME2911**  
Bush



**ME2611**  
Lateral Link  
L=182.5

**ME2612**  
Lateral Link  
L=182.5

**ME2912**  
Bush

**ME2913**  
Bush



**ME2613**  
Lateral Link  
L=247

**ME2613**  
Lateral Link  
L=247

**ME2912**  
Bush

**ME2913**  
Bush



**ME2614**  
Lateral Link  
L=298

**ME2614**  
Lateral Link  
L=298

**ME2912**  
Bush

**ME2914**  
Bush



**ME2615**  
Lateral Link  
L=314.3

**ME2615**  
Lateral Link  
L=314.3



**ME2913**  
Bush

**ME2913**  
Bush

**ME2914**  
Bush

LEFT RIGHT

**MERCEDES**

C215 SERIES

FRONT

S.CL

Year

1996-2007

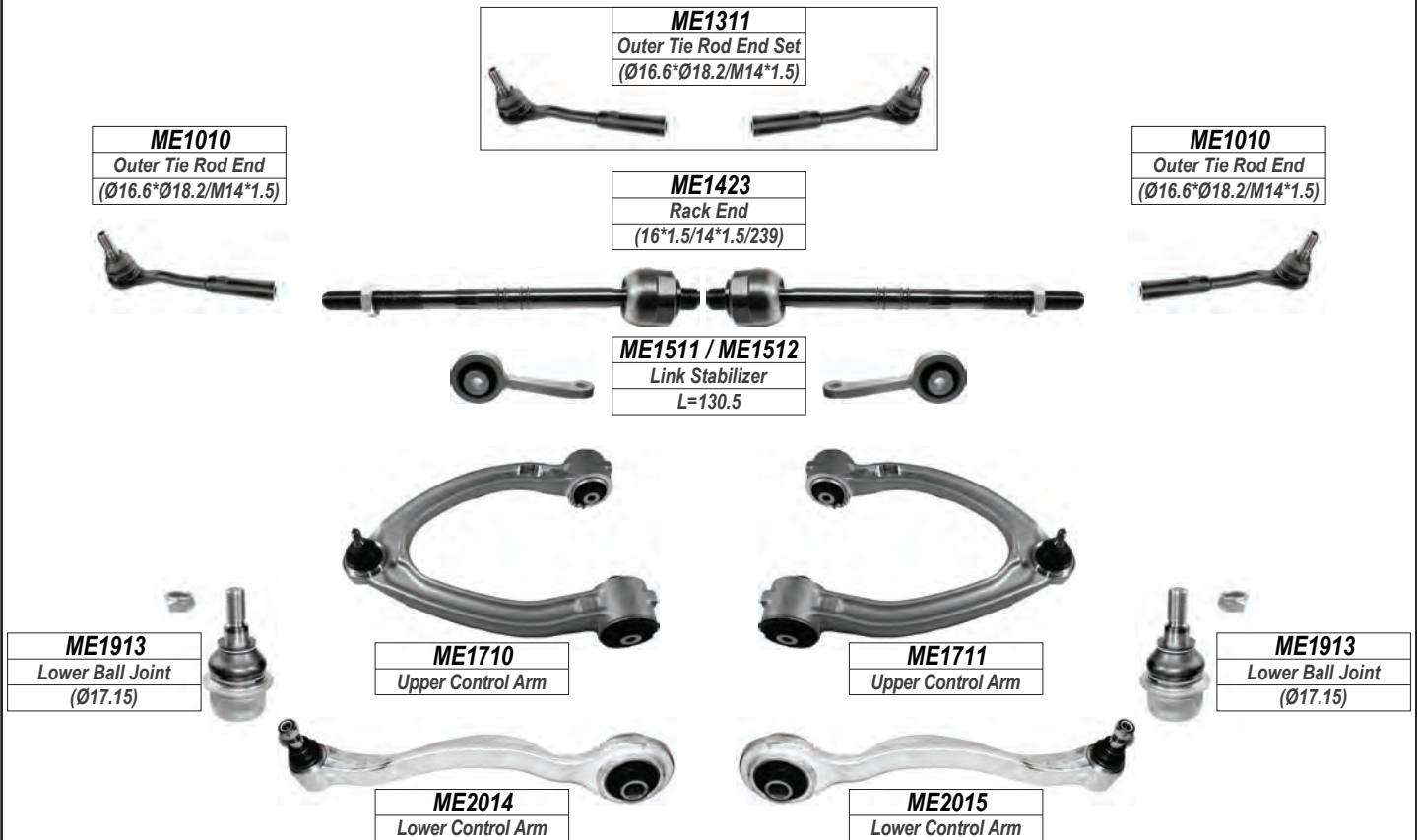

**C215 SERIES**

**REAR**

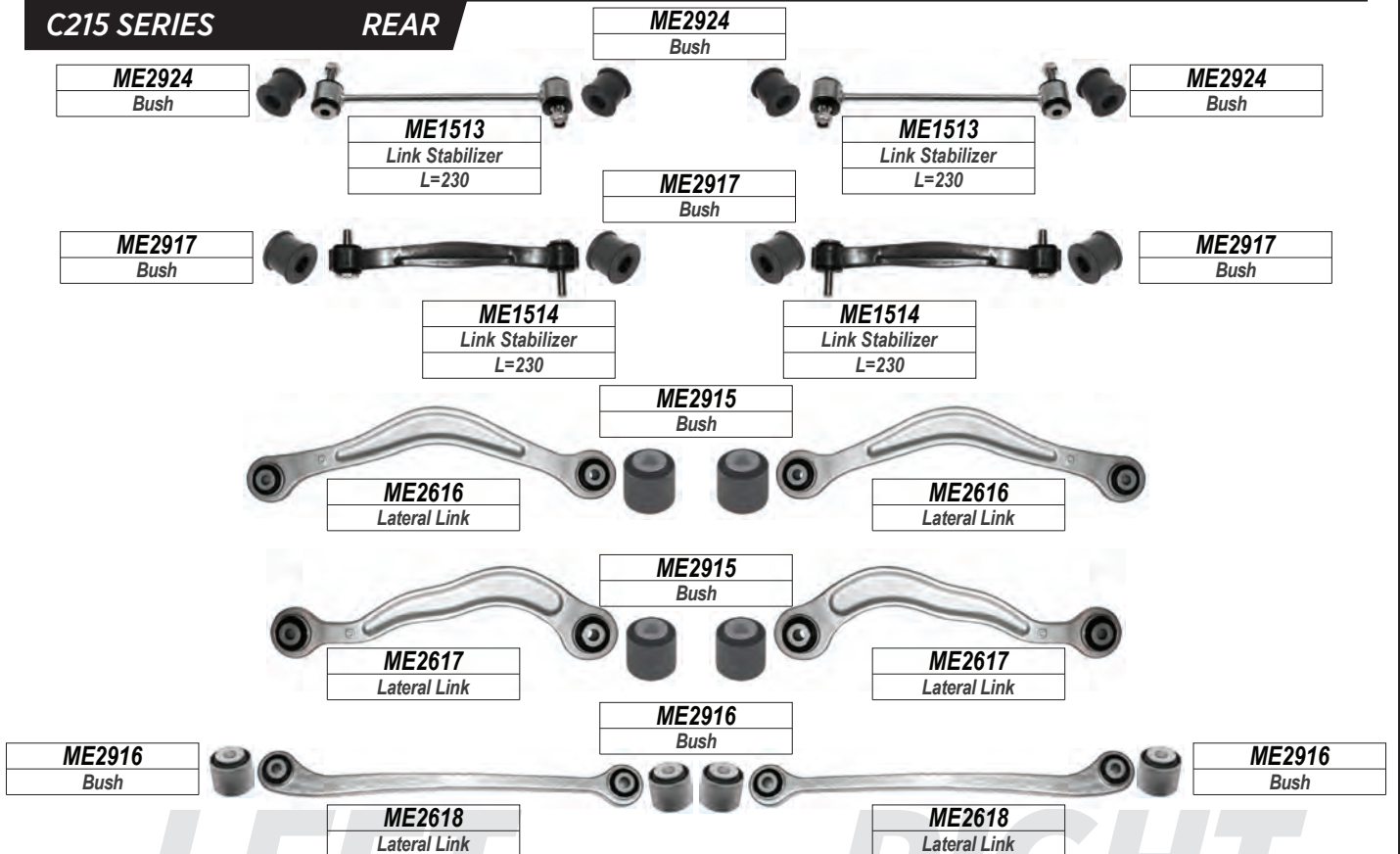

LEFT

RIGHT



**MERCEDES**

**C219 SERIES**

**FRONT**

**CLS**

*Year*

**2004-2010**

**ME1313**

Outer Tie Rod End Set  
(Ø16.6\*Ø18.2/M14\*1.5)



**ME1011**

Outer Tie Rod End  
(Ø16.6\*Ø18.2/M14\*1.5)



**ME1423**

Rack End  
(16\*1.5/14\*1.5/239)



**ME1012**

Outer Tie Rod End  
(Ø16.6\*Ø18.2/M14\*1.5)



**ME1515 / ME1516**

Link Stabilizer  
L=128.5



**ME1610**

Upper Ball Joint  
(Ø13)



**ME1816**

Upper Control Arm Bush



**ME1610**

Upper Ball Joint  
(Ø13)



**ME1712**

Upper Control Arm

**ME1914**

Lower Ball Joint

(Ø22)



**ME1713**

Upper Control Arm

**ME1914**

Lower Ball Joint

(Ø22)



**ME1913**

Lower Ball Joint  
(Ø17.15)



**ME2113**

Lower Control Arm Bush



**ME1913**

Lower Ball Joint  
(Ø17.15)



**ME2114**

Lower Control Arm Bush



**ME2018**

Lower Control Arm



**ME2019**

Lower Control Arm



**ME2114**

Lower Control Arm Bush



**ME2112**

Lower Control Arm Bush



**ME2016**

Lower Control Arm



**ME2017**

Lower Control Arm



**LEFT**

**RIGHT**

**MERCEDES**

**C219 SERIES**

**REAR**

**CLS**

*Year*

**2004-2010**

**ME2917**

Bush



**ME1517**

Link Stabilizer

L=259.5

**ME1517**

Link Stabilizer

L=259.5

**ME2916**

Bush



**ME2621**

Lateral Link

**ME2621**

Lateral Link

**ME2920**

Bush



**ME2624**

Lateral Link

**ME2625**

Lateral Link

**ME2919**

Bush

**ME2918**

Bush



**ME2622**

Lateral Link

**ME2623**

Lateral Link

**ME2918**

Bush



**ME2619**

Lateral Link



**ME2620**

Lateral Link

**LEFT**

**RIGHT**

**MERCEDES**

R129 SERIES

FRONT

SL

Year

1993-2001



**ME2213**  
Center Rod

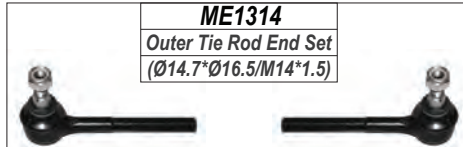

**ME1314**  
Outer Tie Rod End Set  
(Ø14.7\*Ø16.5/M14\*1.5)

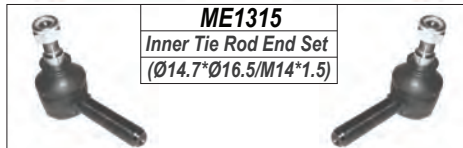

**ME1315**  
Inner Tie Rod End Set  
(Ø14.7\*Ø16.5/M14\*1.5)

**ME1013**  
Outer Tie Rod End  
(Ø14.7\*Ø16.5/M14\*1.5)



**ME1110**  
Inner Tie Rod End  
(Ø14.7\*Ø16.5/M14\*1.5)



**ME1013**  
Outer Tie Rod End  
(Ø14.7\*Ø16.5/M14\*1.5)



**ME1210**  
Tie Rod Assembly



**ME1915**  
Lower Ball Joint  
(Ø18)



**ME2020**  
Lower Control Arm  
<CH;12408

**ME2713**  
Repair Kit

**ME2020**  
Lower Control Arm  
<CH;12408

**ME1915**  
Lower Ball Joint  
(Ø18)



**ME1916**  
Lower Ball Joint  
(Ø20)



**ME2022**  
Lower Control Arm  
CH;12408>

**ME2713**  
Repair Kit

**ME2023**  
Lower Control Arm  
CH;12408>

**ME1917**  
Lower Ball Joint  
(Ø20)

**ME2816**  
Stabilizer Bar Bush



**ME2816**  
Stabilizer Bar Bush



LEFT

RIGHT

**MERCEDES**

**R129 SERIES**

**REAR**

**SL**

*Year*

**1993-2001**

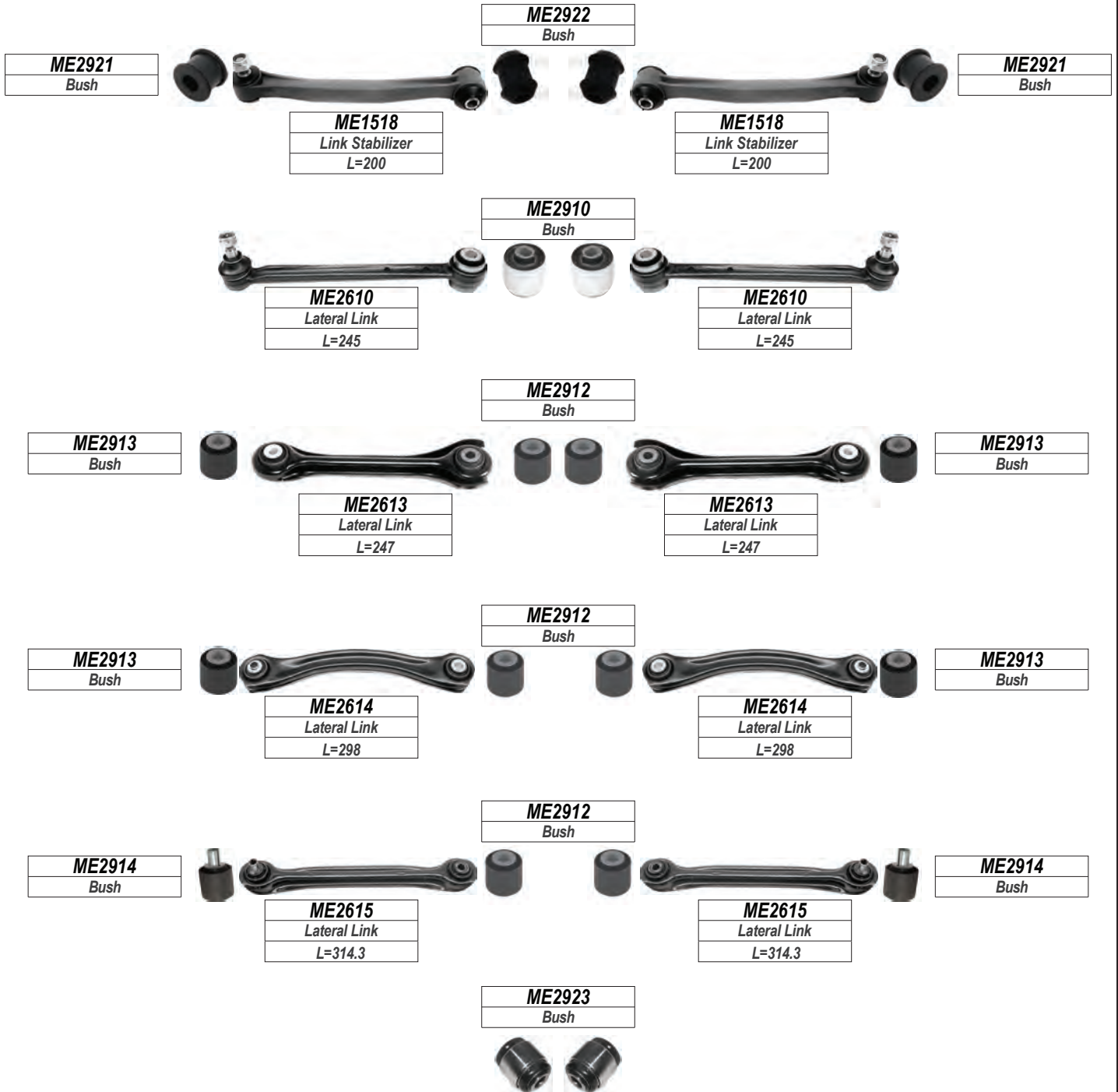

**LEFT**

**RIGHT**

**MERCEDES**

R170 SERIES

FRONT

SLK

Year

1997-2004

**ME2214**

Center Rod  
Only 4 Cylinder



**ME2215**

Center Rod  
Only 6 Cylinder



**ME1316**

Outer Tie Rod End Set  
(Ø14.6\*Ø16.2/M12\*1.5)

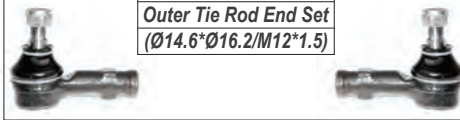

**ME1014**

Outer Tie Rod End  
(Ø14.6\*Ø16.2/M12\*1.5)



**ME1014**

Outer Tie Rod End  
(Ø14.6\*Ø16.2/M12\*1.5)



**ME1714**

Upper Control Arm

**ME1810**

Upper Control Arm Bush

**ME1715**

Upper Control Arm

**ME2714**

Repair Kit

**ME1910**

Lower Ball Joint  
(Ø16)



**ME1910**

Lower Ball Joint  
(Ø16)



**ME2024**

Lower Control Arm



**ME2025**

Lower Control Arm

**ME2115**

Lower Control Arm Bush

LEFT

RIGHT



**MERCEDES**

**R170 SERIES**

**REAR**

**SLK**

*Year*

**1997-2004**

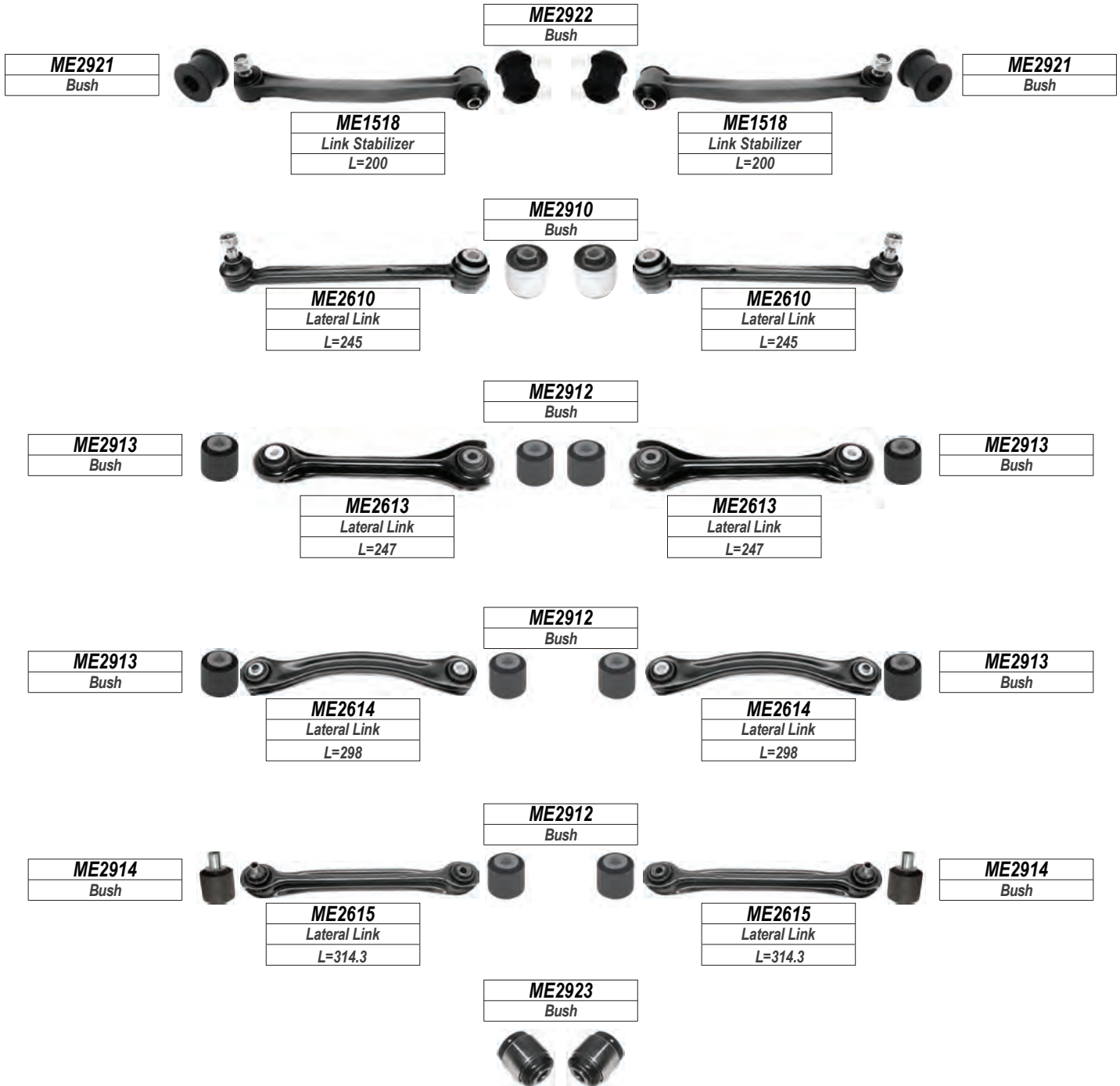

**LEFT**

**RIGHT**

**MERCEDES**

R171 SERIES

FRONT

SLK

Year

2004-2011

**ME1015**  
Outer Tie Rod End  
(Ø16.15\*Ø18.2/M14\*1.5)

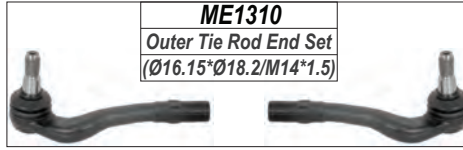

**ME1310**  
Outer Tie Rod End Set  
(Ø16.15\*Ø18.2/M14\*1.5)

**ME1424**  
Rack End  
(16\*1.5/14\*1.5/264)



**ME1016**  
Outer Tie Rod End  
(Ø16.15\*Ø18.2/M14\*1.5)



**ME1519**  
Link Stabilizer  
L=276



**ME1520**  
Link Stabilizer  
L=255



**ME2111**  
Lower Control Arm Bush



**ME2012**  
Upper Control Arm

**ME2013**  
Upper Control Arm



**ME2110**  
Lower Control Arm Bush



**ME2010**  
Lower Control Arm

**ME2011**  
Lower Control Arm



LEFT

RIGHT

**MERCEDES**

R171 SERIES

REAR

SLK

Year

2004-2011

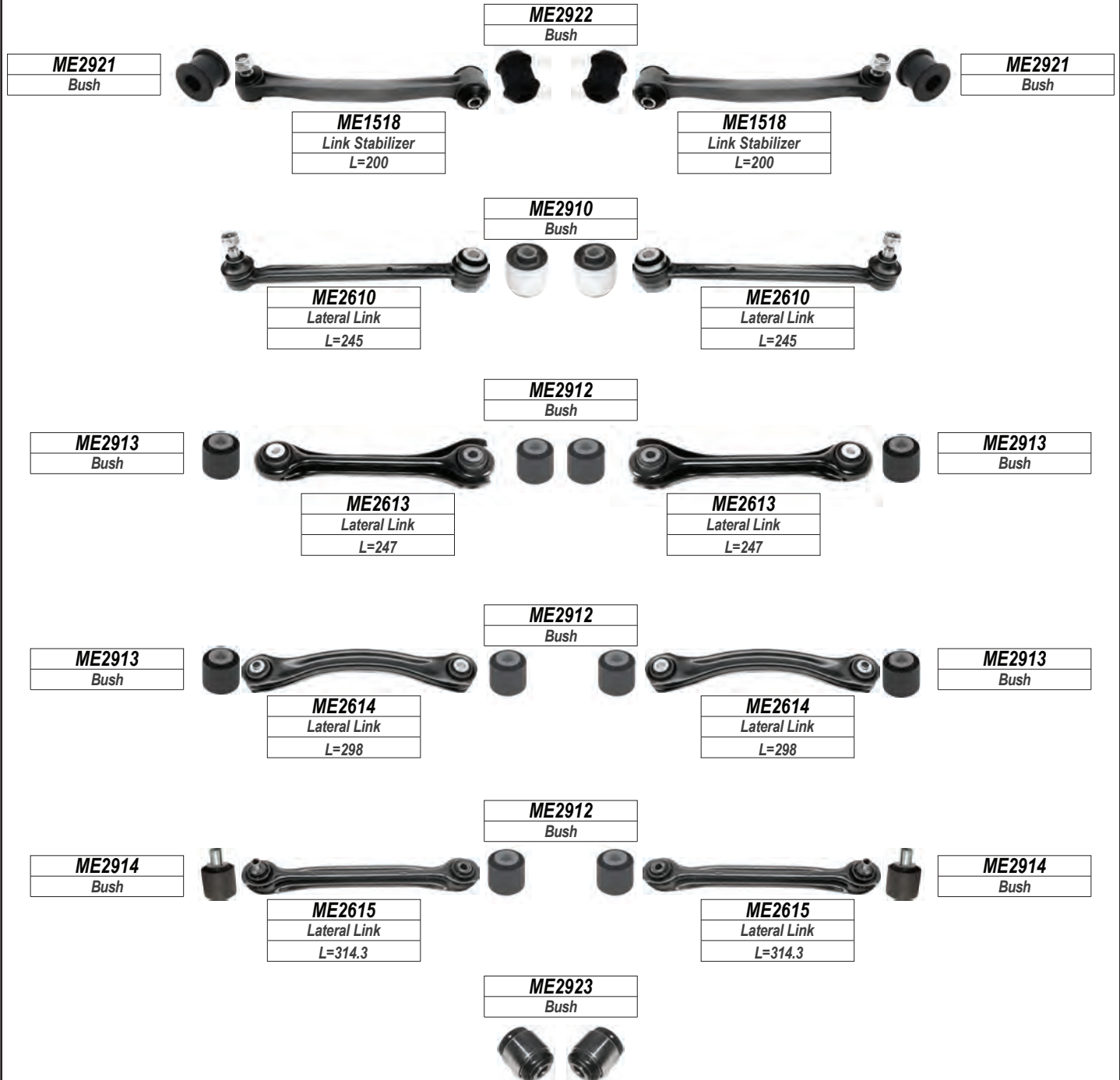

**LEFT**

**RIGHT**

**MERCEDES**

R172 SERIES

FRONT

SLK

Year

2011-2016

**ME1017**  
Outer Tie Rod End  
(Ø16.15\*Ø18.2/M14\*1.5)

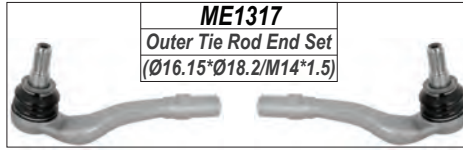

**ME1317**  
Outer Tie Rod End Set  
(Ø16.15\*Ø18.2/M14\*1.5)

**ME1018**  
Outer Tie Rod End  
(Ø16.15\*Ø18.2/M14\*1.5)



**ME1425**  
Rack End  
(16\*1.5/14\*1.5/264)



**ME1521 / ME1522**  
Link Stabilizer  
L=257

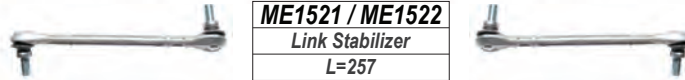

**ME2116**  
Lower Control Arm Bush



**ME2026**  
Lower Control Arm



**ME2027**  
Lower Control Arm



**ME2028**  
Lower Control Arm



**ME2029**  
Lower Control Arm



**C172 SERIES**

**REAR**

**ME2922**  
Bush



**ME2924**  
Bush



**ME2924**  
Bush

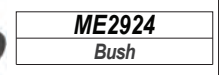

**ME2626**  
Lateral Link



**ME2626**  
Lateral Link



**ME2910**  
Bush

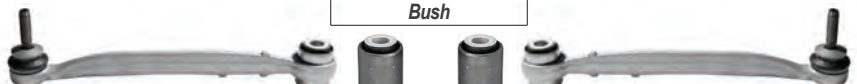

**ME2627**  
Lateral Link

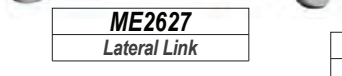

**ME2627**  
Lateral Link



**ME2925**  
Bush



**ME2913**  
Bush



**ME2628**  
Lateral Link

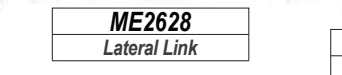

**ME2629**  
Lateral Link

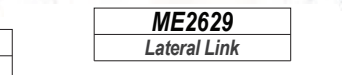

**ME2913**  
Bush

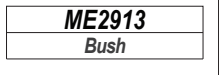

**ME2913**  
Bush



**ME2630**  
Lateral Link

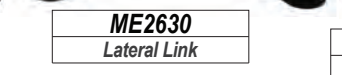

**ME2630**  
Lateral Link

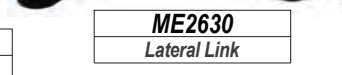

**ME2913**  
Bush

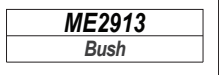

**ME2925**  
Bush



**ME2913**  
Bush



**ME2631**  
Lateral Link

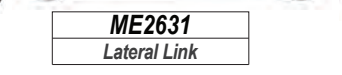

**ME2631**  
Lateral Link



**ME2913**  
Bush

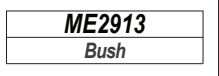

LEFT

RIGHT

**MERCEDES**

R 230 SERIES

FRONT

SL

Year

2002-2012

**ME1010**  
Outer Tie Rod End  
(Ø16.6\*Ø18.2/M14\*1.5)

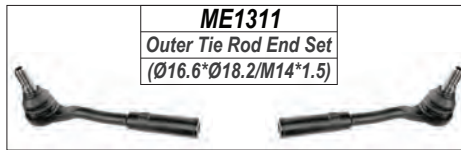

**ME1311**  
Outer Tie Rod End Set  
(Ø16.6\*Ø18.2/M14\*1.5)

**ME1423**  
Rack End  
(16\*1.5/14\*1.5/239)



**ME1010**  
Outer Tie Rod End  
(Ø16.6\*Ø18.2/M14\*1.5)



**ME1523 / ME1524**  
Link Stabilizer  
L=174



**ME1610**  
Upper Ball Joint  
(Ø13)



**ME1816**  
Upper Control Arm Bush



**ME1610**  
Upper Ball Joint  
(Ø13)

**ME1712**  
Upper Control Arm

**ME1713**  
Upper Control Arm

**ME1914**  
Lower Ball Joint  
(Ø22)

**ME1914**  
Lower Ball Joint  
(Ø22)

**ME1913**  
Lower Ball Joint  
(Ø17.15)



**ME2113**  
Lower Control Arm Bush



**ME1913**  
Lower Ball Joint  
(Ø17.15)

**ME2114**  
Lower Control Arm Bush



**ME2018**  
Lower Control Arm

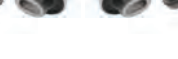

**ME2019**  
Lower Control Arm



**ME2114**  
Lower Control Arm Bush



**ME2112**  
Lower Control Arm Bush



**ME2016**  
Lower Control Arm

**ME2017**  
Lower Control Arm

LEFT

RIGHT



**MERCEDES**

R 230 SERIES

REAR

CLS

Year

2002-2012

**ME2917**

Bush



**ME1517**

Link Stabilizer

L=259.5

**ME1517**

Link Stabilizer

L=259.5

**ME2916**

Bush



**ME2621**

Lateral Link

**ME2621**

Lateral Link

**ME2920**

Bush



**ME2624**

Lateral Link

**ME2625**

Lateral Link

**ME2919**

Bush

**ME2918**

Bush



**ME2622**

Lateral Link

**ME2623**

Lateral Link

**ME2918**

Bush



**ME2619**

Lateral Link



**ME2620**

Lateral Link

**LEFT**

**RIGHT**

**MERCEDES**

W116 SERIES

FRONT

S CLASS

Year

1973-1981

**ME2216**

Center Rod

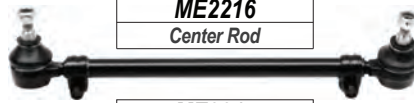

**ME2217**

Center Rod



**ME1318**

Outer Tie Rod End Set  
(Ø12.6\*Ø14.2/M14\*1.5)

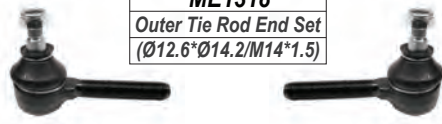

**ME1319**

Inner Tie Rod End Set  
(Ø14.6\*Ø16.2/M12\*1.5)

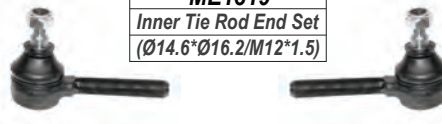

**ME1019**

Outer Tie Rod End  
(Ø12.6\*Ø14.2/M14\*1.5)



**ME1111**

Inner Tie Rod End  
(Ø14.6\*Ø16.2/M12\*1.5)



**ME1019**

Outer Tie Rod End  
(Ø12.6\*Ø14.2/M14\*1.5)



**ME1525**

Link Stabilizer  
L=108



**ME1811**

Upper Control Arm Bush



**ME1716**

Upper Control Arm



**ME1717**

Upper Control Arm



**ME1918**

Lower Ball Joint  
(Ø18.2)



**ME2926**

Bush



**ME1918**

Lower Ball Joint  
(Ø18.2)



**ME2717**

Repair Kit



W116 SERIES

REAR

**ME1526**

Link Stabilizer  
L=100.5



LEFT

RIGHT

**MERCEDES**

W123 SERIES

FRONT

ALL MODEL

Year

1977-1986

**ME2216**

Center Rod

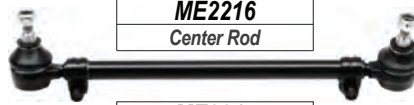

**ME2217**

Center Rod



**ME2218**

Center Rod



**ME1320**

Outer Tie Rod End Set  
(Ø12.6\*Ø14.2/M16\*1.5)

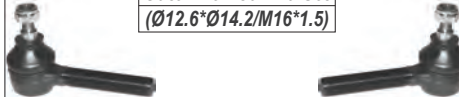

**ME1321**

Inner Tie Rod End Set  
(Ø12.6\*Ø14.2/M16\*1.5)

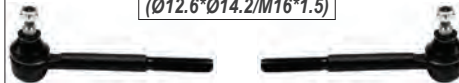

**ME1322**

Inner Tie Rod End Set  
(Ø12.6\*Ø14.2/M16\*1.5)

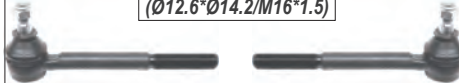

**ME1114**

Inner Tie Rod End  
(Ø12.6\*Ø14.2/M16\*1.5)



**ME1115**

Inner Tie Rod End  
(Ø12.6\*Ø14.2/M16\*1.5)



**ME1525**

Link Stabilizer  
L=108



**ME1020**

Outer Tie Rod End  
(Ø12.6\*Ø14.2/M16\*1.5)



**ME1020**

Outer Tie Rod End  
(Ø12.6\*Ø14.2/M16\*1.5)



**LEFT**

**RIGHT**

**MERCEDES**

W123 SERIES

FRONT

ALL MODEL

Year

1977-1986

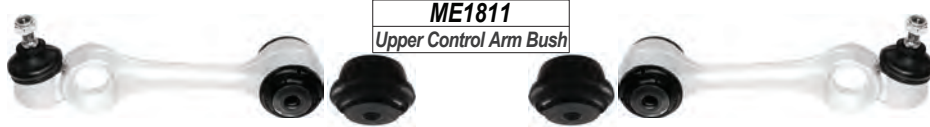

**ME1811**  
Upper Control Arm Bush

**ME1716**  
Upper Control Arm

**ME1717**  
Upper Control Arm



**ME1918**  
Lower Ball Joint  
(Ø18.2)



**ME1918**  
Lower Ball Joint  
(Ø18.2)

**ME2926**  
Bush



**ME2717**  
Repair Kit



W123 SERIES

REAR

**ME1526**  
Link Stabilizer  
L=100.5



**LEFT**

**RIGHT**

**MERCEDES**

W124 SERIES

FRONT

ALL MODEL

Year

1986-1996

**ME2219**

Center Rod



**ME2220**

Center Rod

Ø14.5\*Ø16



**ME2221**

Center Rod

Ø12.5\*Ø14



**BM1317**

Outer Tie Rod End Set

(Ø12.6\*Ø14.2/M14\*1.5)

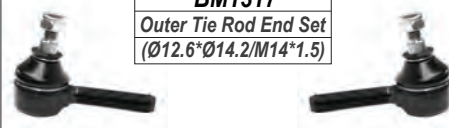

**ME1323**

Inner Tie Rod End Set

(Ø12.6\*Ø14.2/M14\*1.5)



**BM1026**

Outer Tie Rod End

(Ø12.6\*Ø14.2/M14\*1.5)



**ME1116**

Inner Tie Rod End

(Ø12.6\*Ø14.2/M14\*1.5)



**BM1026**

Outer Tie Rod End

(Ø12.6\*Ø14.2/M14\*1.5)



**ME1915**

Lower Ball Joint

(Ø18)



**ME2713**

Repair Kit



**ME1915**

Lower Ball Joint

(Ø18)



**ME2020**

Lower Control Arm



**ME2021**

Lower Control Arm

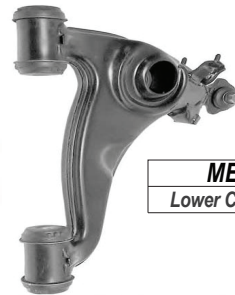

**ME1916**

Lower Ball Joint

(Ø20)



**ME2713**

Repair Kit



**ME1917**

Lower Ball Joint

(Ø20)



**ME2022**

Lower Control Arm



**ME2023**

Lower Control Arm



**ME2827**

Shock Mounting



**ME2816**

Stabilizer Bar Bush

ID:18.5



**ME2817**

Stabilizer Bar Bush

ID:24



**ME2827**

Shock Mounting



LEFT

RIGHT



**MERCEDES**

W124 SERIES

REAR

ALL MODEL

Year

1986-1996

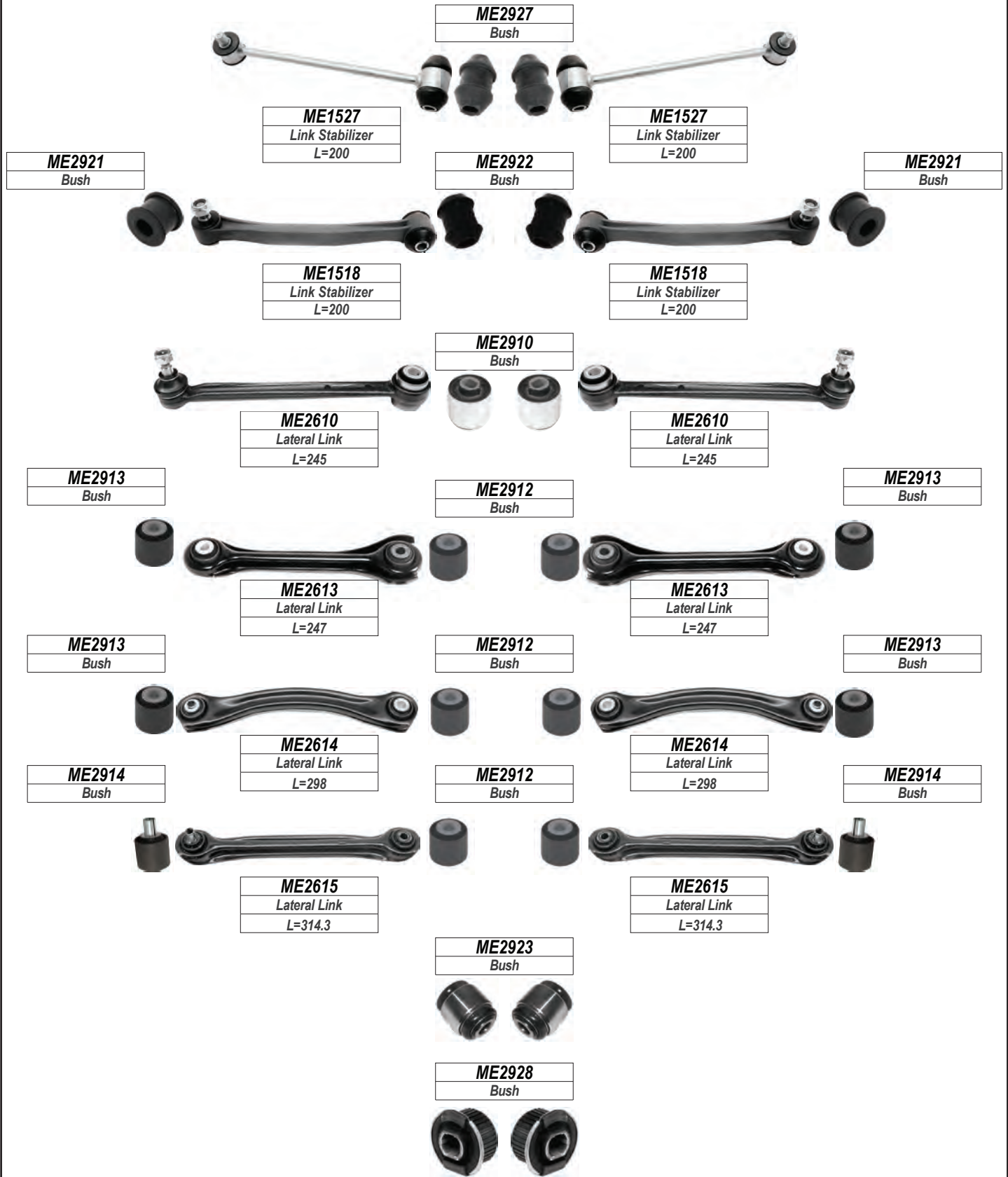

LEFT

RIGHT

**MERCEDES**

W126 SERIES

FRONT

ALL MODEL

Year

1981-1993

**ME2216**

Center Rod

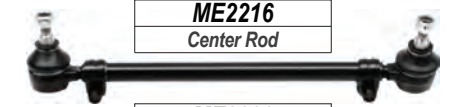

**ME2222**

Center Rod

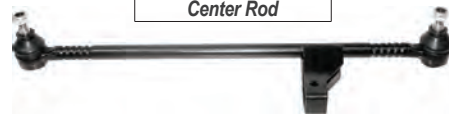

**ME1318**

Outer Tie Rod End Set  
(Ø12.6\*Ø14.2/M14\*1.5)

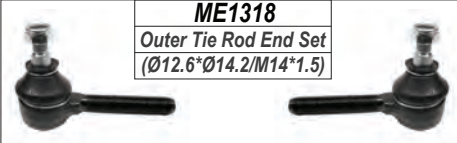

**ME1319**

Inner Tie Rod End Set  
(Ø14.6\*Ø16.2/M12\*1.5)

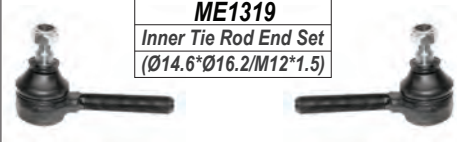

**ME1019**

Outer Tie Rod End  
(Ø12.6\*Ø14.2/M14\*1.5)



**ME1111**

Inner Tie Rod End  
(Ø14.6\*Ø16.2/M12\*1.5)



**ME1019**

Outer Tie Rod End  
(Ø12.6\*Ø14.2/M14\*1.5)



**ME1525**

Link Stabilizer  
L=108

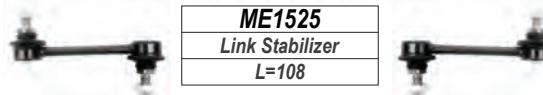

**ME1812**

Upper Control Arm Bush



**ME1718**

Upper Control Arm



**ME1719**

Upper Control Arm



**ME1918**

Lower Ball Joint  
(Ø18.2)



**ME2926**

Bush



**ME1918**

Lower Ball Joint  
(Ø18.2)



**ME1919**

Lower Ball Joint  
(Ø21)



**ME2717**

Repair Kit



**ME1919**

Lower Ball Joint  
(Ø21)



W126 SERIES

REAR

**ME2913**

Bush



**ME1526**

Link Stabilizer  
L=100.5



**ME2913**

Bush



LEFT

RIGHT

**MERCEDES**

W140 SERIES

FRONT

S CLASS

Year

1993-2000

**ME2210**

Center Rod



**ME1324**

Outer Tie Rod End Set  
(Ø14.2\*Ø16.2/M16\*1.5)

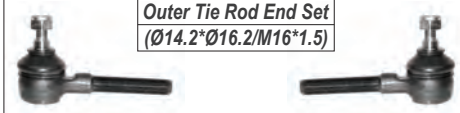

**ME1325**

Inner Tie Rod End Set  
(Ø14.2\*Ø16.2/M16\*1.5)



**ME1021**

Outer Tie Rod End  
(Ø14.2\*Ø16.2/M16\*1.5)



**ME1112**

Inner Tie Rod End  
(Ø14.2\*Ø16.2/M16\*1.5)



**ME1021**

Outer Tie Rod End  
(Ø14.2\*Ø16.2/M16\*1.5)



**ME1528 / ME1529**

Link Stabilizer  
L=152



**ME1720**

Upper Control Arm



**ME1721**

Upper Control Arm

**ME1920**

Lower Ball Joint  
(Ø17.8)



**ME1920**

Lower Ball Joint  
(Ø17.8)



**LEFT**

**RIGHT**

**MERCEDES**

**R140 SERIES**

**REAR**

**S CLASS**

*Year*

**1993-2000**



**ME2924**  
Bush

**ME2924**  
Bush

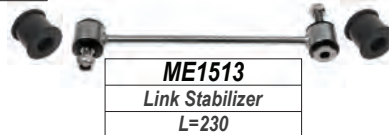
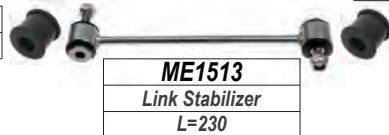

**ME2924**  
Bush

**ME2917**  
Bush

**ME2917**  
Bush



**ME2917**  
Bush

**ME2929**  
Bush



**ME2930**  
Bush

**ME2931**  
Bush



**ME2931**  
Bush

**ME2932**  
Bush

**ME2931**  
Bush



**ME2931**  
Bush

**ME2932**  
Bush

**ME2931**  
Bush



**ME2931**  
Bush

**ME2923**  
Bush



**LEFT**

**RIGHT**

**MERCEDES**

W163 SERIES

FRONT

ML

Year

1998-2005

**ME1326**

Outer Tie Rod End Set  
(Ø15.1\*Ø18.1/M16\*1.5)

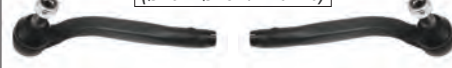

**ME1022**

Outer Tie Rod End  
(Ø15.1\*Ø18.1/M16\*1.5)



**ME1410**

Rack End  
(16\*1.5/16\*1.5/160)



**ME1023**

Outer Tie Rod End  
(Ø15.1\*Ø18.1/M16\*1.5)



**ME1531 / ME1532**

Link Stabilizer  
L=128



**ME1813**

Upper Control Arm Bush



**ME1722**

Upper Control Arm

**ME1723**

Upper Control Arm

**ME1911**

Lower Ball Joint  
(Ø19.9)



**ME2117**

Lower Control Arm Bush



**ME1911**

Lower Ball Joint  
(Ø19.9)



**ME1912**

Lower Ball Joint  
(Ø16.2)



**ME2030**

Lower Control Arm

**ME2031**

Lower Control Arm

**ME1912**

Lower Ball Joint  
(Ø16.2)



**ME2118**

Lower Control Arm Bush

**LEFT**

**RIGHT**



**MERCEDES**

**W163 SERIES**

**REAR**

**ML**

*Year*

**1998-2005**

<b>ME1533</b>
Link Stabilizer
L=222



<b>ME1724</b>
Upper Control Arm

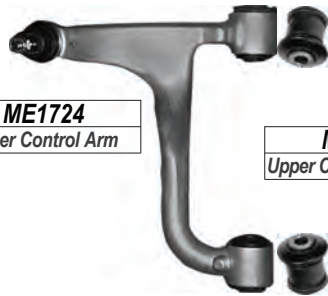

<b>ME1813</b>
Upper Control Arm Bush

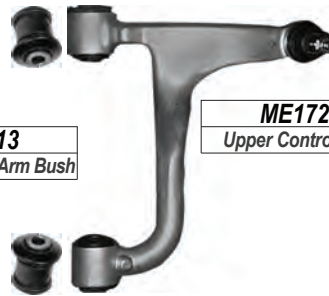

<b>ME1725</b>
Upper Control Arm

<b>ME2933</b>
Bush



<b>ME2636</b>
Lateral Link
L=378

<b>ME2637</b>
Lateral Link
L=378

**LEFT**

**RIGHT**

**MERCEDES**

W164-X164 SERIES FRONT

ML/GL CLASS

Year

2005-2012

**ME1024**  
Outer Tie Rod End  
(Ø15\*Ø18.9/M14\*1.5)

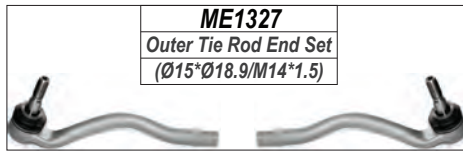

**ME1327**  
Outer Tie Rod End Set  
(Ø15\*Ø18.9/M14\*1.5)

**ME1411**  
Rack End  
(16\*1.5/14\*1.5/202)



**ME1025**  
Outer Tie Rod End  
(Ø15\*Ø18.9/M14\*1.5)



**ME1534**  
Link Stabilizer  
L=195.5



**ME1814**  
Upper Control Arm Bush

**ME1726**  
Upper Control Arm



**ME1727**  
Upper Control Arm



**ME2121**  
Lower Control Arm Bush



**ME2121**  
Lower Control Arm Bush



**ME1921**  
Lower Ball Joint  
(Ø19.3)



**ME1921**  
Lower Ball Joint  
(Ø19.3)



**ME2122**  
Lower Control Arm Bush

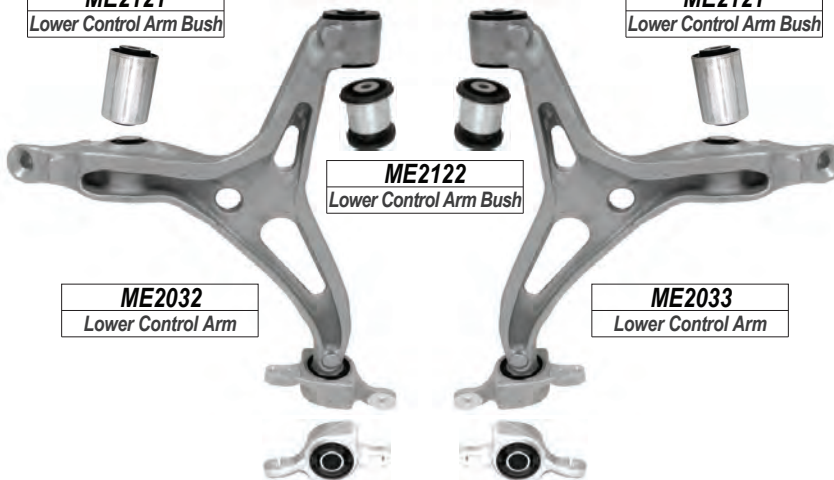

**ME1922**  
Lower Ball Joint  
(Ø19.3)



**ME2032**  
Lower Control Arm



**ME2033**  
Lower Control Arm



**ME1922**  
Lower Ball Joint  
(Ø19.3)



**ME2119 / ME2120**  
Lower Control Arm Bush

**LEFT**

**RIGHT**

**MERCEDES**

W164-X164 SERIES REAR

ML/GL CLASS

Year

2005-2012

**ME1535**  
Link Stabilizer  
L=117



**ME2931**  
Bush

**ME2934**  
Bush



**ME2638**  
Lateral Link



**ME2638**  
Lateral Link

**ME2934**  
Bush

**ME2931**  
Bush

**ME2934**  
Bush



**ME2639**  
Lateral Link



**ME2640**  
Lateral Link

**ME2934**  
Bush

**LEFT**

**RIGHT**

**MERCEDES**

W166-X166 SERIES FRONT

ML/GL CLASS

Year

2012-

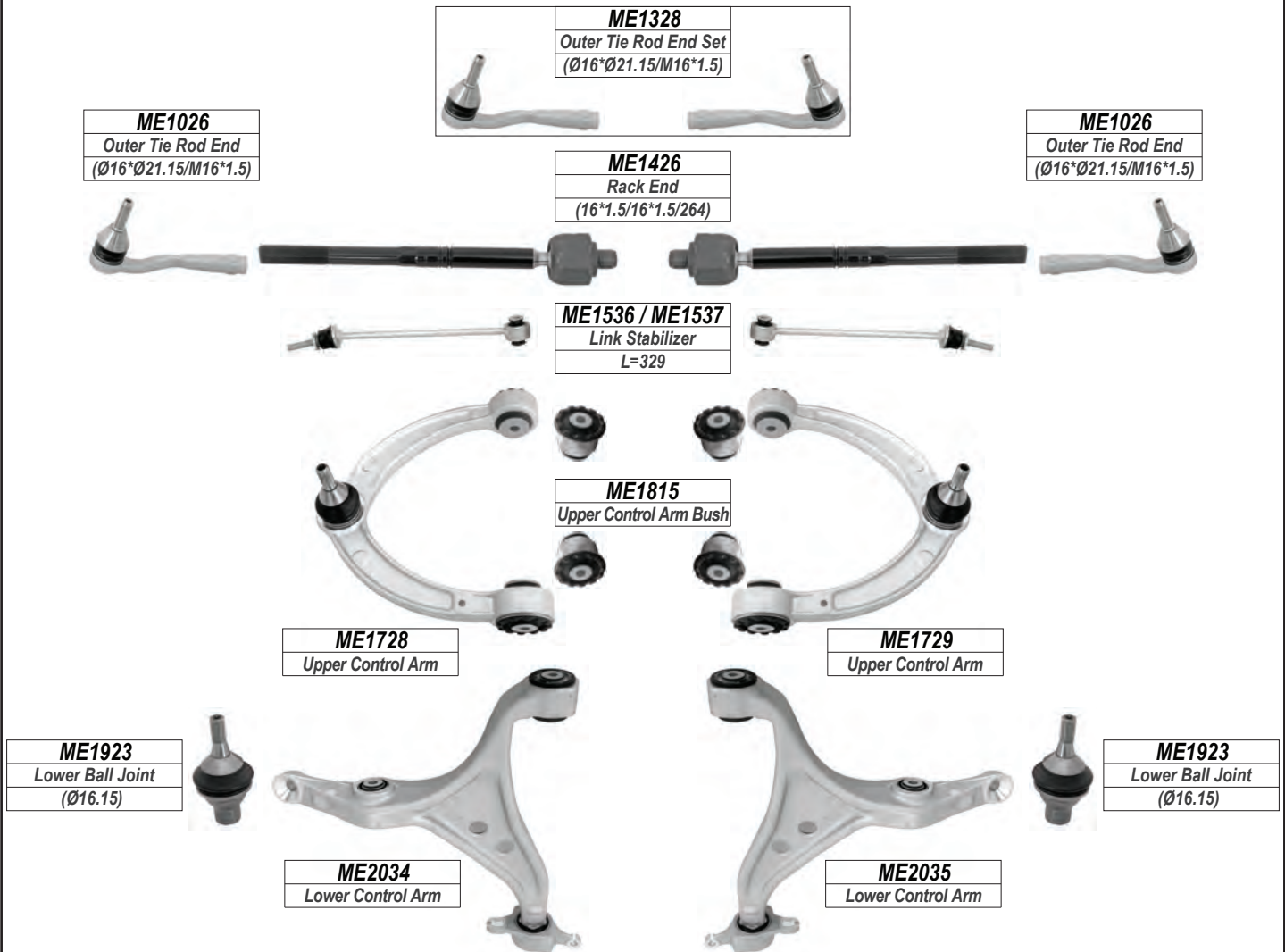

**W166-X166 SERIES REAR**



LEFT

RIGHT

**MERCEDES**

W168 SERIES

FRONT

A CLASS

Year

2000-2005

**ME1329**  
Outer Tie Rod End Set  
(Ø14.7\*Ø16.4/M12\*1.5)



**ME1027**  
Outer Tie Rod End  
(Ø14.7\*Ø16.4/M12\*1.5)



**ME1412**  
Rack End  
(14\*1.5/12\*1.5/197)



**ME1028**  
Outer Tie Rod End  
(Ø14.7\*Ø16.4/M12\*1.5)



**ME1538**  
Link Stabilizer  
L=220



**ME2123**  
Lower Control Arm Bush

**ME1924**  
Lower Ball Joint  
(Ø13.7)



**ME1924**  
Lower Ball Joint  
(Ø13.7)

**ME2036**  
Lower Control Arm

**ME2037**  
Lower Control Arm

**ME2124**  
Lower Control Arm Bush

**ME2828**  
Shock Mounting



**ME2828**  
Shock Mounting



LEFT

RIGHT



**MERCEDES**

W169 SERIES

FRONT

A CLASS

Year

2005-2013

**ME1330**  
Outer Tie Rod End Set  
(Ø16.7\*Ø18.3/M14\*1.5)



**ME1029**  
Outer Tie Rod End  
(Ø16.7\*Ø18.3/M14\*1.5)



**ME1413**  
Rack End  
(14\*1.5/14\*1.5/201)



**ME1030**  
Outer Tie Rod End  
(Ø16.7\*Ø18.3/M14\*1.5)



**ME1539**  
Link Stabilizer  
L=244

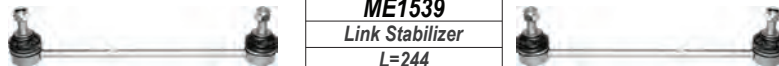

**ME1540**  
Link Stabilizer  
L=244.5



**ME2125**  
Lower Control Arm Bush



**ME1925**  
Lower Ball Joint  
(Ø15.5)



**ME1925**  
Lower Ball Joint  
(Ø15.5)



**ME2038**  
Lower Control Arm

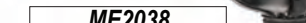

**ME2126**  
Lower Control Arm Bush



**ME2039**  
Lower Control Arm



**ME2829**  
Shock Mounting



**ME2829**  
Shock Mounting



W169 SERIES

REAR

**ME2935**  
Bush



**ME1541**  
Link Stabilizer  
L=87



**ME1541**  
Link Stabilizer  
L=87



LEFT

RIGHT

**MERCEDES**

W176 SERIES

FRONT

A CLASS

Year

2012-

**ME1031**  
Outer Tie Rod End  
(Ø16.3\*Ø20.2/M14\*1.5)



**ME1331**  
Outer Tie Rod End Set  
(Ø16.3\*Ø20.2/M14\*1.5)

**ME1427**  
Rack End  
(14\*1.5/14\*1.5/222)



**ME1032**  
Outer Tie Rod End  
(Ø16.3\*Ø20.2/M14\*1.5)



**ME1542**  
Link Stabilizer  
L=333



**ME2129**  
Lower Control Arm Bush



**ME2040**  
Lower Control Arm



**ME2041**  
Lower Control Arm



**ME2830**  
Shock Mounting  
W/Out Sports Package



**ME2127 / ME2128**  
Lower Control Arm Bush



**ME2830**  
Shock Mounting  
W/Out Sports Package



**ME2831**  
Shock Mounting  
With Sports Package



**ME2831**  
Shock Mounting  
With Sports Package



W176 SERIES

REAR



**ME2936**  
Bush

**ME1543**  
Link Stabilizer  
L=79



**ME1543**  
Link Stabilizer  
L=79



LEFT

RIGHT

**MERCEDES**

W201 SERIES

FRONT

100-CLASS (190E)

Year

1984-1994

**ME2211**

Center Rod



**ME2212**

Center Rod



**ME1332**

Outer Tie Rod End Set  
(Ø12.6\*Ø14.2/M14\*1.5)

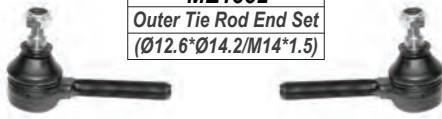

**ME1333**

Inner Tie Rod End Set  
(Ø12.6\*Ø14.2/M14\*1.5)

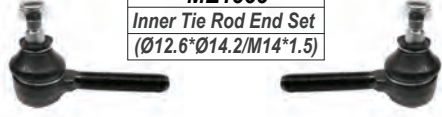

**ME1033**

Outer Tie Rod End  
(Ø12.6\*Ø14.2/M14\*1.5)



**ME1113**

Inner Tie Rod End Set  
(Ø12.6\*Ø14.2/M14\*1.5)



**ME1033**

Outer Tie Rod End  
(Ø12.6\*Ø14.2/M14\*1.5)



**ME1544**

Link Stabilizer  
L=120

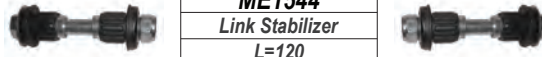

**ME1915**

Lower Ball Joint  
(Ø18)



**ME2713**

Repair Kit



**ME1915**

Lower Ball Joint  
(Ø18)



**ME2042**

Lower Control Arm



**ME2043**

Lower Control Arm



**ME2818**

Stabilizer Bar Bush  
(Ø24)



**ME2937**

Bush



**ME2819**

Stabilizer Bar Bush  
(Ø25)



LEFT

RIGHT

**MERCEDES**

**R201 SERIES**

**REAR**

**100-CLASS (190E)**

*Year*

**1984-1994**

**ME2921**  
Bush

**ME2922**  
Bush

**ME2921**  
Bush



**ME1518**  
Link Stabilizer  
L=200

**ME1518**  
Link Stabilizer  
L=200

**ME2910**  
Bush



**ME2610**  
Lateral Link  
L=245

**ME2610**  
Lateral Link  
L=245

**ME2913**  
Bush

**ME2912**  
Bush

**ME2913**  
Bush



**ME2613**  
Lateral Link  
L=247

**ME2613**  
Lateral Link  
L=247

**ME2913**  
Bush

**ME2912**  
Bush

**ME2913**  
Bush



**ME2614**  
Lateral Link  
L=298

**ME2614**  
Lateral Link  
L=298

**ME2914**  
Bush

**ME2912**  
Bush

**ME2914**  
Bush



**ME2615**  
Lateral Link  
L=314.3

**ME2615**  
Lateral Link  
L=314.3

**ME2923**  
Bush

**ME2928**  
Bush

**ME2938**  
Bush



**LEFT**

**RIGHT**

**MERCEDES**

W202/C208 SERIES FRONT

C/CLK CLASS

Year

1993-2001



**ME2223**  
Center Rod  
4 Cylinder



**ME2224**  
Center Rod  
6 Cylinder

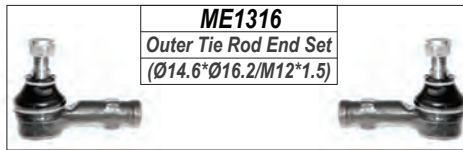

**ME1316**  
Outer Tie Rod End Set  
(Ø14.6\*Ø16.2/M12\*1.5)

**ME1014**  
Outer Tie Rod End  
(Ø14.6\*Ø16.2/M12\*1.5)



**ME1014**  
Outer Tie Rod End  
(Ø14.6\*Ø16.2/M12\*1.5)



**ME1519**  
Link Stabilizer  
L=276



**ME1714**  
Upper Control Arm

**ME1810**  
Upper Control Arm Bush

**ME1715**  
Upper Control Arm

**ME1910**  
Lower Ball Joint  
(Ø16)



**ME2024**  
Lower Control Arm

**ME2714**  
Repair Kit

**ME2025**  
Lower Control Arm

**ME1910**  
Lower Ball Joint  
(Ø16)



**ME2115**  
Lower Control Arm Bush

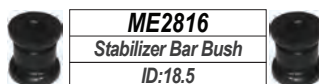

**ME2816**  
Stabilizer Bar Bush  
ID:18.5

LEFT

RIGHT



**MERCEDES**

W202/C208 SERIES REAR

C/CLK CLASS

Year

1993-2001

**ME2921**

Bush



**ME2922**

Bush



**ME2921**

Bush



**ME1518**

Link Stabilizer  
L=200



**ME1518**

Link Stabilizer  
L=200



**ME2910**

Bush



**ME2610**

Lateral Link  
L=245



**ME2610**

Lateral Link  
L=245



**ME2913**

Bush



**ME2912**

Bush



**ME2913**

Bush



**ME2613**

Lateral Link  
L=247



**ME2613**

Lateral Link  
L=247



**ME2913**

Bush



**ME2912**

Bush



**ME2913**

Bush



**ME2614**

Lateral Link  
L=298



**ME2614**

Lateral Link  
L=298



**ME2914**

Bush



**ME2912**

Bush



**ME2914**

Bush



**ME2615**

Lateral Link  
L=314.3



**ME2615**

Lateral Link  
L=314.3



**ME2923**

Bush



**ME2928**

Bush



**LEFT**

**RIGHT**

**MERCEDES**

W203 SERIES

FRONT

C CLASS

Year

2000-2007

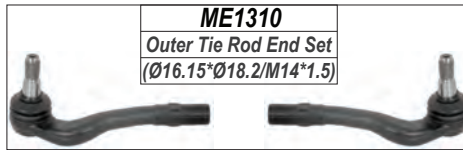

**ME1310**  
Outer Tie Rod End Set  
(Ø16.15\*Ø18.2/M14\*1.5)



**ME1015**  
Outer Tie Rod End  
(Ø16.15\*Ø18.2/M14\*1.5)



**ME1016**  
Outer Tie Rod End  
(Ø16.15\*Ø18.2/M14\*1.5)

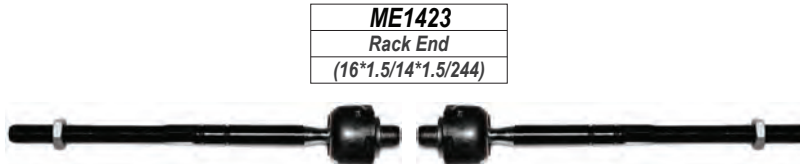

**ME1423**  
Rack End  
(16\*1.5/14\*1.5/244)

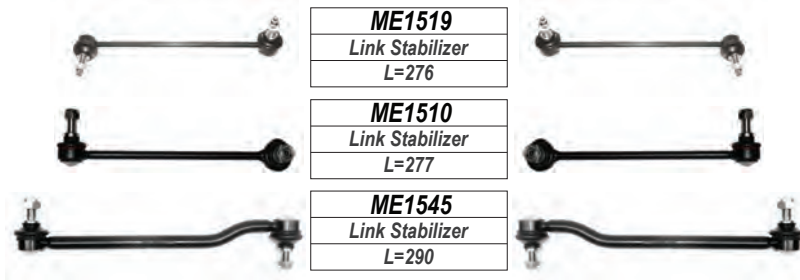

**ME1519**  
Link Stabilizer  
L=276

**ME1510**  
Link Stabilizer  
L=277

**ME1545**  
Link Stabilizer  
L=290



**ME2111**  
Lower Control Arm Bush

**ME2012**  
Upper Control Arm

**ME2013**  
Upper Control Arm



**ME2110**  
Lower Control Arm Bush

**ME2010**  
Lower Control Arm

**ME2011**  
Lower Control Arm



**ME2044**  
Lower Control Arm

**ME2045**  
Lower Control Arm



**ME2832**  
Shock Mounting



**ME2832**  
Shock Mounting

LEFT

RIGHT

**MERCEDES**

**W203 SERIES**

**REAR**

**C CLASS**

*Year*

**2000-2007**

**ME2910**

Bush



**ME1546**

Link Stabilizer

L=257

**ME1546**

Link Stabilizer

L=257

**ME2911**

Bush



**ME2611**

Lateral Link

L=182.5

**ME2612**

Lateral Link

L=182.5

**ME2921**

Bush

**ME2922**

Bush

**ME2921**

Bush



**ME1518**

Link Stabilizer

L=200

**ME1518**

Link Stabilizer

L=200

**ME2910**

Bush



**ME2610**

Lateral Link

L=245

**ME2610**

Lateral Link

L=245

**ME2913**

Bush

**ME2912**

Bush

**ME2913**

Bush



**ME2613**

Lateral Link

L=247

**ME2613**

Lateral Link

L=247

**ME2913**

Bush

**ME2912**

Bush

**ME2913**

Bush



**ME2614**

Lateral Link

L=298

**ME2614**

Lateral Link

L=298

**ME2914**

Bush

**ME2912**

Bush

**ME2914**

Bush



**ME2615**

Lateral Link

L=314.3

**ME2615**

Lateral Link

L=314.3

**ME2712**

Repair Kit



**LEFT**

**RIGHT**

**MERCEDES**

W204 SERIES

FRONT

C CLASS

Year

2007-2014

**ME1017**  
Outer Tie Rod End  
(Ø16.15\*Ø18.2/M14\*1.5)

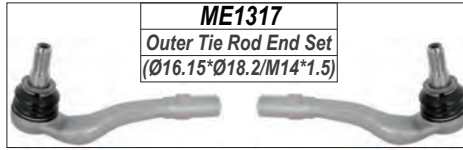

**ME1317**  
Outer Tie Rod End Set  
(Ø16.15\*Ø18.2/M14\*1.5)

**ME1414**  
Rack End  
(16\*1.5/14\*1.5/255)



**ME1018**  
Outer Tie Rod End  
(Ø16.15\*Ø18.2/M14\*1.5)

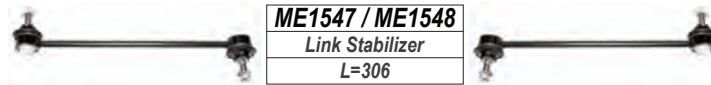

**ME1547 / ME1548**  
Link Stabilizer  
L=306

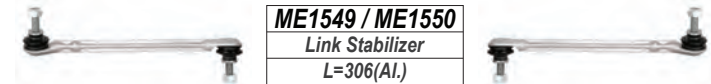

**ME1549 / ME1550**  
Link Stabilizer  
L=306(AI.)



**ME2111**  
Lower Control Arm Bush

**ME2012**  
Upper Control Arm

**ME2013**  
Upper Control Arm



**ME2116**  
Lower Control Arm Bush

**ME2026**  
Lower Control Arm

**ME2027**  
Lower Control Arm



**ME2130**  
Lower Control Arm Bush

**ME2046**  
Lower Control Arm  
4 Matic Only

**ME2047**  
Lower Control Arm  
4 Matic Only

**ME2833**  
Shock Mounting



**ME2833**  
Shock Mounting



LEFT

RIGHT

**MERCEDES**

W204 SERIES

REAR

C CLASS

Year

2007-2014

**ME2917**

Bush

**ME2927**

Bush

**ME2927**

Bush

**ME1551**

Link Stabilizer

L=232

**ME1552**

Link Stabilizer

L=232

**ME2939**

Bush

**ME2940**

Bush

**ME2940**

Bush

**ME2645**

Lateral Link

**ME2646**

Lateral Link

**ME2931**

Bush

**ME2941**

Bush

**ME2941**

Bush

**ME2647**

Lateral Link

**ME2648**

Lateral Link

**ME2942**

Bush

**ME2943**

Bush

**ME2943**

Bush

**ME2649**

Lateral Link

**ME2650**

Lateral Link

**ME2916**

Bush

**ME2651**

Lateral Link

**ME2651**

Lateral Link

**ME2923**

Bush

**ME2836**

Shock Mounting

**ME2836**

Shock Mounting



**LEFT**

**RIGHT**



**MERCEDES**

W205 SERIES

FRONT

C CLASS

Year

2013-

**ME1034**  
Outer Tie Rod End  
(Ø16\*Ø21.2/M14\*1.5)

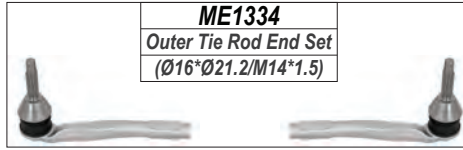

**ME1334**  
Outer Tie Rod End Set  
(Ø16\*Ø21.2/M14\*1.5)

**ME1035**  
Outer Tie Rod End  
(Ø16\*Ø21.2/M14\*1.5)



**ME1428**  
Rack End  
(16\*1.5/14\*1.5/240)



**ME1553 / ME1554**  
Link Stabilizer  
L=141.5



**ME1816**  
Upper Control Arm Bush



**ME1730**  
Upper Control Arm



**ME1731**  
Upper Control Arm

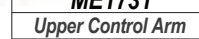

**ME2131**  
Lower Control Arm Bush



**ME2048**  
Lower Control Arm



**ME2049**  
Lower Control Arm



**ME2132**  
Lower Control Arm Bush



**ME2133**  
Lower Control Arm Bush



**ME2132**  
Lower Control Arm Bush



**ME2152**  
Lower Control Arm Bush



**ME2050**  
Lower Control Arm



**ME2051**  
Lower Control Arm



**ME2152**  
Lower Control Arm Bush



LEFT

RIGHT

**MERCEDES**

**W205 SERIES**

**REAR**

**C CLASS**

*Year*

**2013-**

**ME2927**  
Bush

**ME2917**  
Bush

**ME2927**  
Bush



**ME1551**  
Link Stabilizer  
L=232

**ME1552**  
Link Stabilizer  
L=232

**ME2939**  
Bush

**ME2940**  
Bush



**ME2940**  
Bush

**ME2645**  
Lateral Link

**ME2646**  
Lateral Link

**ME2931**  
Bush

**ME2941**  
Bush



**ME2941**  
Bush

**ME2647**  
Lateral Link

**ME2648**  
Lateral Link

**ME2942**  
Bush

**ME2943**  
Bush



**ME2943**  
Bush

**ME2649**  
Lateral Link

**ME2650**  
Lateral Link

**ME2916**  
Bush

**ME2651**  
Lateral Link



**ME2651**  
Lateral Link

**ME2923**  
Bush



**LEFT**

**RIGHT**

**MERCEDES**

W210 SERIES

FRONT

E CLASS

Year

1995-2002

**ME1036**  
Outer Tie Rod End  
(Ø16.6\*Ø18.2/M14\*1.5)

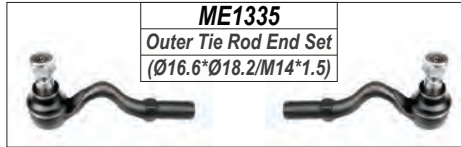

**ME1335**  
Outer Tie Rod End Set  
(Ø16.6\*Ø18.2/M14\*1.5)

**ME1415**  
Rack End  
(16\*1.5/14\*1.5/246)



**ME1037**  
Outer Tie Rod End  
(Ø16.6\*Ø18.2/M14\*1.5)



**ME1555 / ME1556**  
Link Stabilizer  
L=115



**ME1810**  
Upper Control Arm Bush



**ME1714**  
Upper Control Arm

**ME1715**  
Upper Control Arm

**ME2134**  
Lower Control Arm Bush

**ME2134**  
Lower Control Arm Bush

**ME1910**  
Lower Ball Joint  
(Ø16)



**ME2721**  
Repair Kit



**ME1910**  
Lower Ball Joint  
(Ø16)



**ME2053**  
Lower Control Arm



**ME2135**  
Lower Control Arm Bush

**ME2816**  
Stabilizer Bar Bush  
ID:18.5



**ME2054**  
Lower Control Arm



LEFT

RIGHT

**MERCEDES**

W210 SERIES

REAR

E CLASS

Year

1995-2002

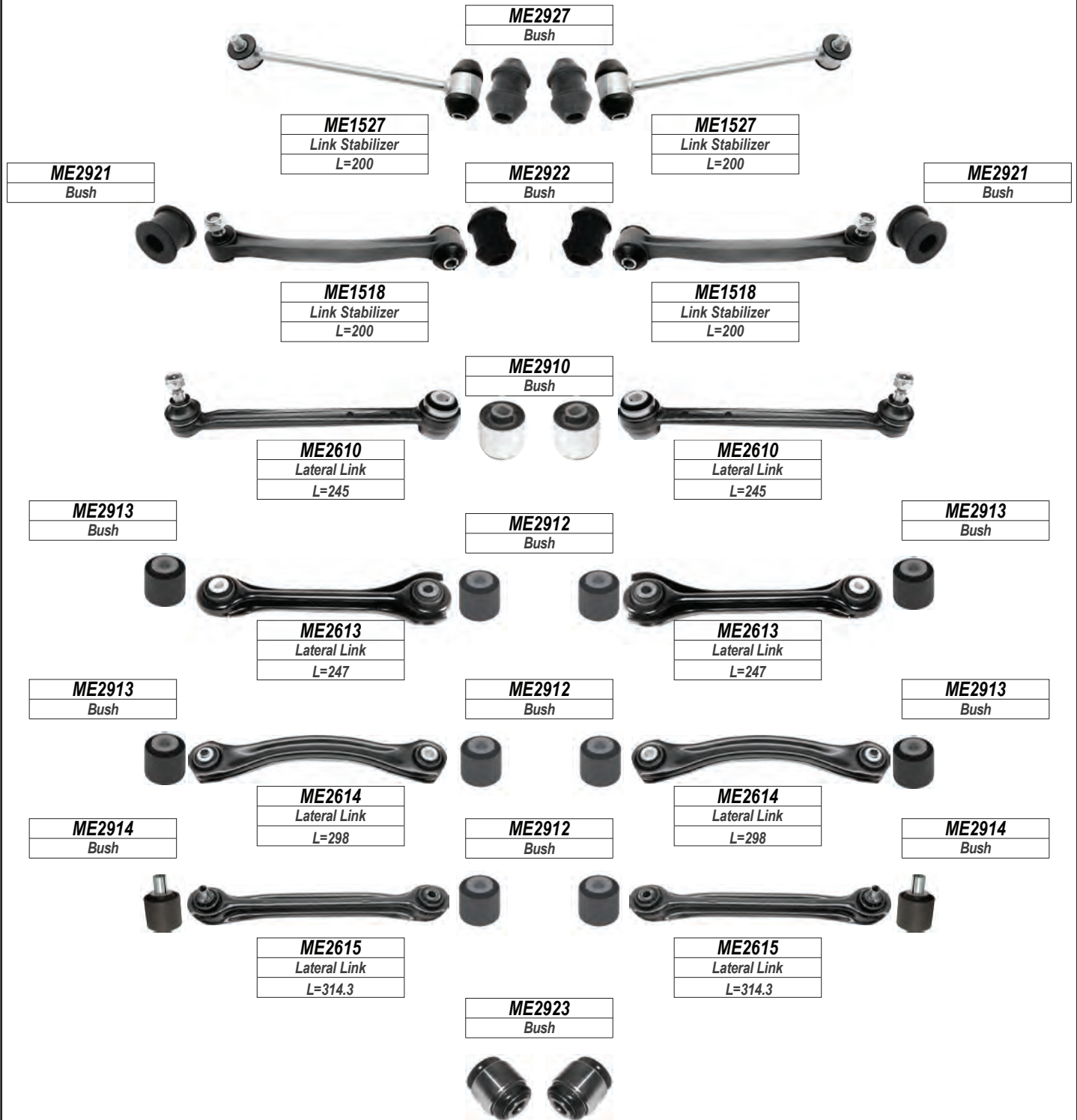

**LEFT**

**RIGHT**

**MERCEDES**

W211 SERIES

FRONT

E-CLASS

Year

2002-2009

**ME1011**  
Outer Tie Rod End  
(Ø16.6\*Ø18.2/M14\*1.5)

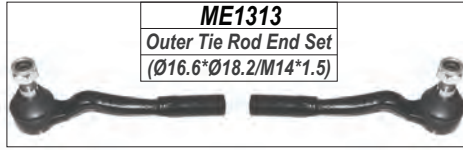

**ME1423**  
Rack End  
(16\*1.5/14\*1.5/244)

**ME1012**  
Outer Tie Rod End  
(Ø16.6\*Ø18.2/M14\*1.5)



**ME1515 / ME1516**  
Link Stabilizer  
L=128.5

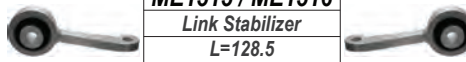

**ME1610**  
Upper Ball Joint  
(Ø13)



**ME1816**  
Upper Control Arm Bush

**ME1610**  
Upper Ball Joint  
(Ø13)



**ME1712**  
Upper Control Arm

**ME1713**  
Upper Control Arm

**ME1914**  
Lower Ball Joint  
(Ø22)



**ME1914**  
Lower Ball Joint  
(Ø22)



**ME1913**  
Lower Ball Joint  
(Ø17.15)



**ME2113**  
Lower Control Arm Bush



**ME1913**  
Lower Ball Joint  
(Ø17.15)

**ME2114**  
Lower Control Arm Bush



**ME2018**  
Lower Control Arm

**ME2019**  
Lower Control Arm



**ME2114**  
Lower Control Arm Bush

**ME2112**  
Lower Control Arm Bush



**ME2016**  
Lower Control Arm

**ME2017**  
Lower Control Arm

**ME2834**  
Shock Mounting



**ME2834**  
Shock Mounting



**LEFT**

**RIGHT**



**MERCEDES**

W211 SERIES

REAR

E-CLASS

Year

2002-2009

**ME2917**

Bush



**ME1517**

Link Stabilizer

L=259.5

**ME1517**

Link Stabilizer

L=259.5

**ME2916**

Bush



**ME2621**

Lateral Link

**ME2621**

Lateral Link

**ME2920**

Bush



**ME2624**

Lateral Link

**ME2625**

Lateral Link

**ME2919**

Bush



**ME2918**

Bush

**ME2622**

Lateral Link

**ME2623**

Lateral Link

**ME2918**

Bush



**ME2619**

Lateral Link



**ME2620**

Lateral Link

**LEFT**

**RIGHT**

**MERCEDES**

W212 SERIES

FRONT

E-CLASS

Year

2009-

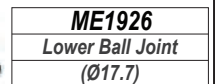
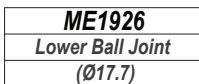
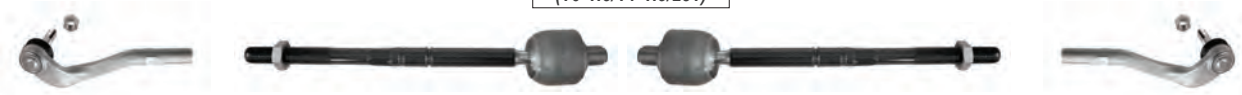
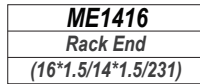
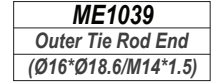
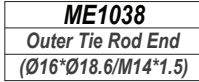
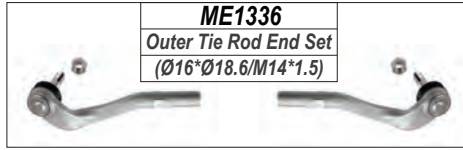

**LEFT**

**RIGHT**

**MERCEDES**

W212 SERIES

REAR

E-CLASS

Year

2009-

**ME2927**  
Bush

**ME2917**  
Bush

**ME2927**  
Bush



**ME1551**  
Link Stabilizer  
L=232

**ME1552**  
Link Stabilizer  
L=232

**ME2940**  
Bush

**ME2939**  
Bush

**ME2940**  
Bush



**ME2645**  
Lateral Link

**ME2646**  
Lateral Link

**ME2941**  
Bush

**ME2931**  
Bush

**ME2941**  
Bush



**ME2647**  
Lateral Link

**ME2648**  
Lateral Link

**ME2943**  
Bush

**ME2942**  
Bush

**ME2943**  
Bush



**ME2649**  
Lateral Link

**ME2650**  
Lateral Link

**ME2916**  
Bush

**ME2651**  
Lateral Link

**ME2651**  
Lateral Link



**ME2923**  
Bush



**ME2836**  
Shock Mounting

**ME2836**  
Shock Mounting



**LEFT**

**RIGHT**

**MERCEDES**

W220 SERIES

FRONT

S-CLASS

Year

1999-2005

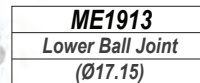
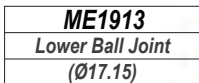
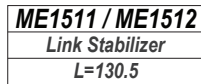
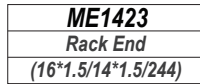
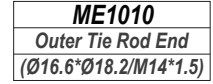
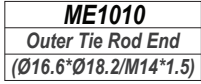

**LEFT**

**RIGHT**

**MERCEDES**

W220 SERIES

REAR

S-CLASS

Year

1999-2005

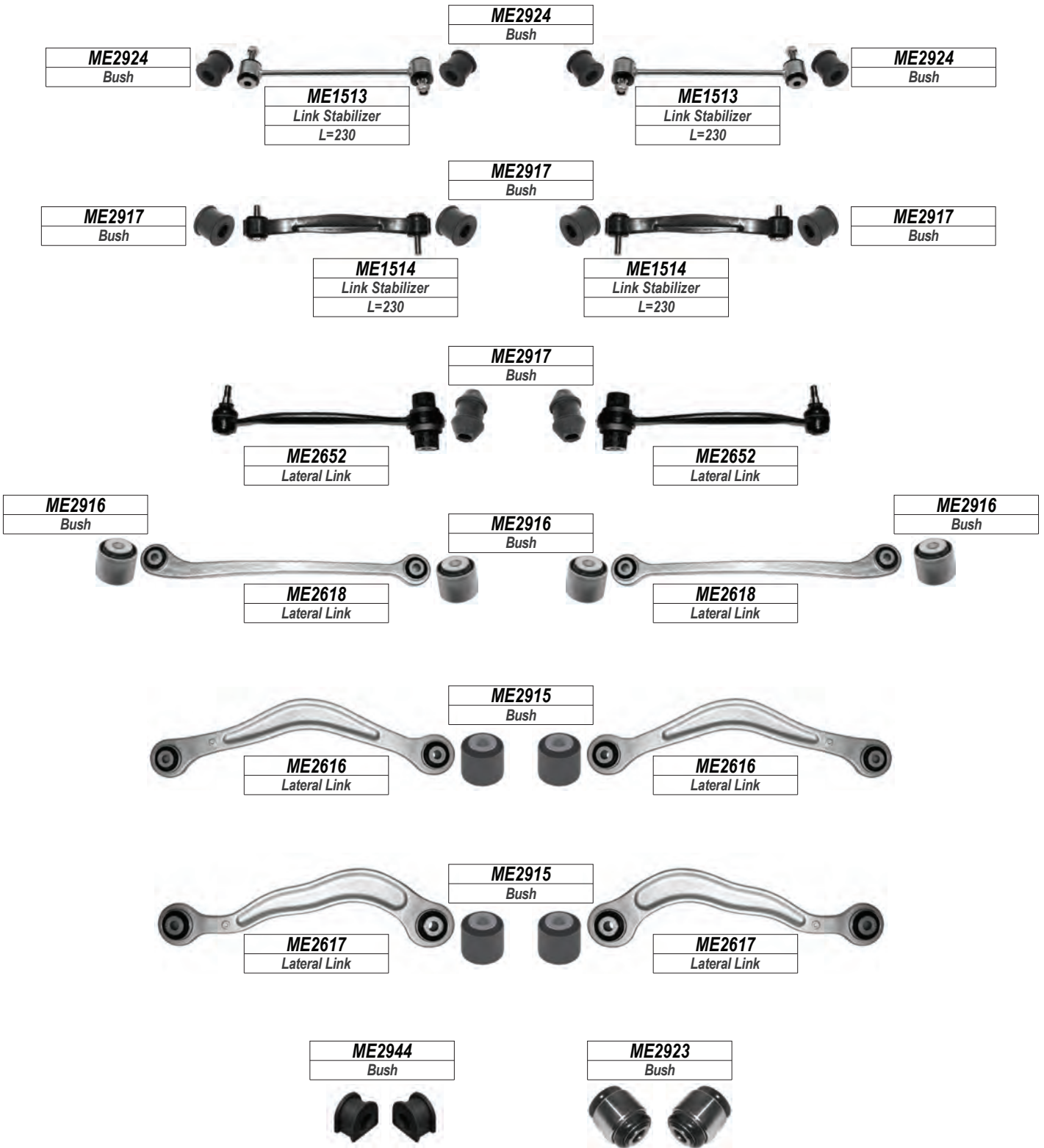

**LEFT**

**RIGHT**



**MERCEDES**

W221 SERIES

FRONT

S-CLASS

Year

2006-2013

**ME1040**  
Outer Tie Rod End  
(Ø16.6\*Ø18.2/M14\*1.5)

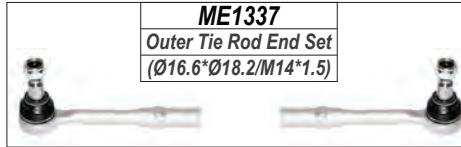

**ME1337**  
Outer Tie Rod End Set  
(Ø16.6\*Ø18.2/M14\*1.5)

**ME1040**  
Outer Tie Rod End  
(Ø16.6\*Ø18.2/M14\*1.5)



**ME1417**  
Rack End  
(16\*1.5/14\*1.5/263)



**ME1559 / ME1560**  
Link Stabilizer  
L=242.5



**ME1561 / ME1562**  
Link Stabilizer  
L=260



**ME1816**  
Upper Control Arm Bush

**ME1732**  
Upper Control Arm

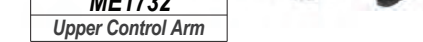

**ME1733**  
Upper Control Arm



**ME2139**  
Lower Control Arm Bush



**ME2061**  
Lower Control Arm



**ME2062**  
Lower Control Arm

**ME2140**  
Lower Control Arm Bush



**ME2063**  
Lower Control Arm



**ME2064**  
Lower Control Arm



LEFT

RIGHT

**MERCEDES**

W221 SERIES

REAR

S-CLASS

Year

2006-2013

**ME1563 / ME1564**  
Link Stabilizer  
L=117



**ME1535**  
Link Stabilizer  
L=117



**ME2945**  
Bush



**ME2655**  
Lateral Link

**ME2656**  
Lateral Link

**ME2931**  
Bush

**ME2941**  
Bush



**ME2941**  
Bush

**ME2653**  
Lateral Link

**ME2654**  
Lateral Link

**ME2931**  
Bush

**ME2941**  
Bush



**ME2941**  
Bush

**ME2657**  
Lateral Link

**ME2658**  
Lateral Link

**ME2946**  
Bush

**ME2947**  
Bush



**ME2947**  
Bush

**ME2659**  
Lateral Link

**ME2660**  
Lateral Link

**ME2923**  
Bush



**LEFT**

**RIGHT**

**MERCEDES**

W245 SERIES

FRONT

B CLASS

Year

2006-2012

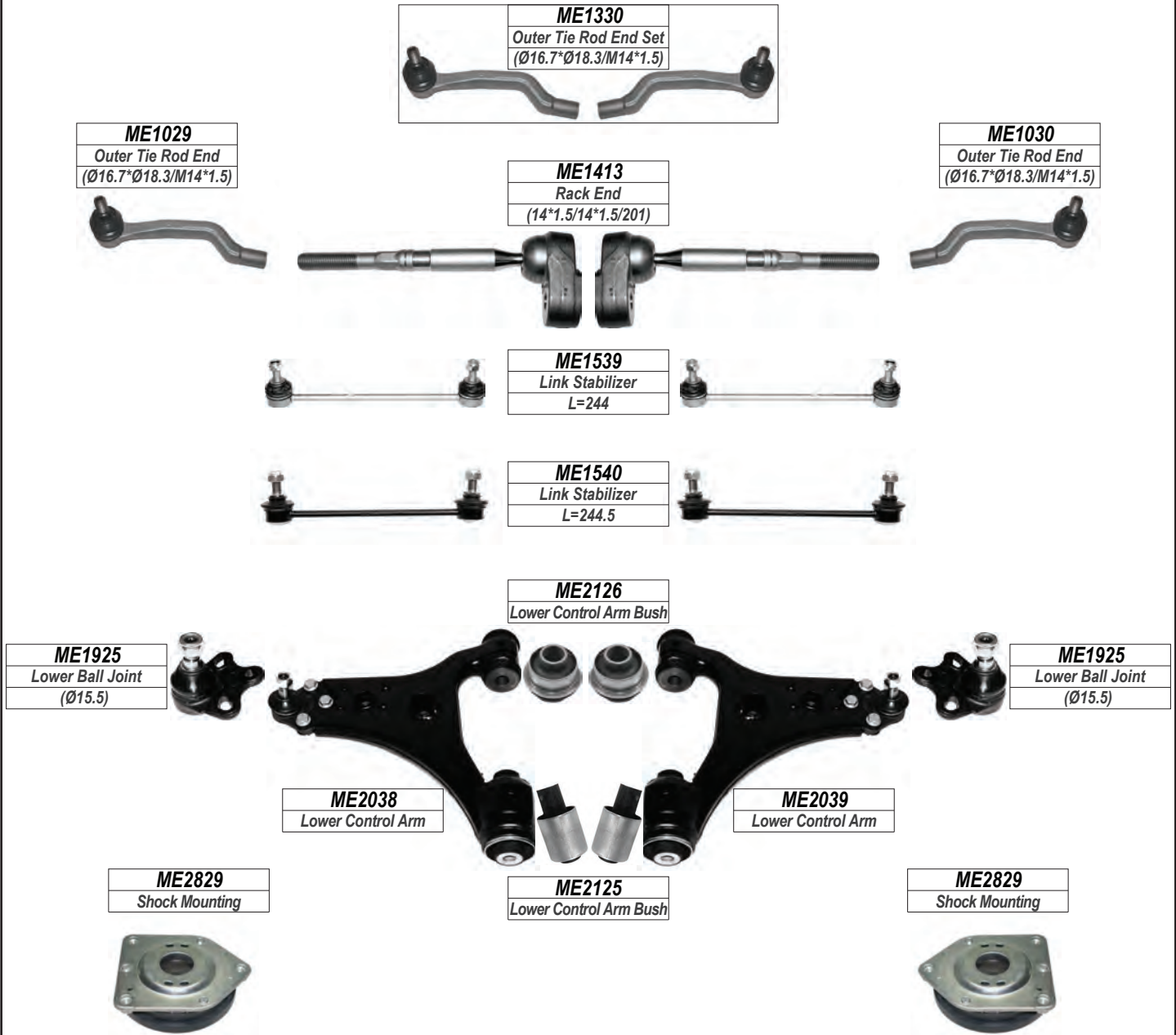

W245 SERIES

REAR



LEFT

RIGHT

**MERCEDES**

W246 SERIES

FRONT

B CLASS

Year

2012-

**ME1031**  
Outer Tie Rod End  
(Ø16.3\*Ø20.2/M14\*1.5)



**ME1331**  
Outer Tie Rod End Set  
(Ø16.3\*Ø20.2/M14\*1.5)

**ME1427**  
Rack End  
(14\*1.5/14\*1.5/222)



**ME1032**  
Outer Tie Rod End  
(Ø16.3\*Ø20.2/M14\*1.5)



**ME1542**  
Link Stabilizer  
L=333



**ME2129**  
Lower Control Arm Bush



**ME2040**  
Lower Control Arm

**ME2041**  
Lower Control Arm

**ME2830**  
Shock Mounting  
W/Out Sports Package



**ME2127 / ME2128**  
Lower Control Arm Bush



**ME2830**  
Shock Mounting  
W/Out Sports Package



**ME2831**  
Shock Mounting  
With Sports Package



**ME2831**  
Shock Mounting  
With Sports Package



W246 SERIES

REAR

**ME2936**  
Bush



**ME1543**  
Link Stabilizer  
L=79

**ME1543**  
Link Stabilizer  
L=79

LEFT

RIGHT

**MERCEDES**

W251 SERIES

FRONT

R-CLASS

Year

2006-2013

**ME1041**  
Outer Tie Rod End  
(Ø15\*Ø18.9/M14\*1.5)

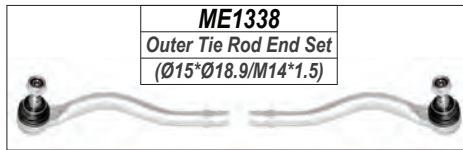

**ME1338**  
Outer Tie Rod End Set  
(Ø15\*Ø18.9/M14\*1.5)

**ME1411**  
Rack End  
(16\*1.5/14\*1.5/202)



**ME1042**  
Outer Tie Rod End  
(Ø15\*Ø18.9/M14\*1.5)



**ME1565**  
Link Stabilizer  
L=205

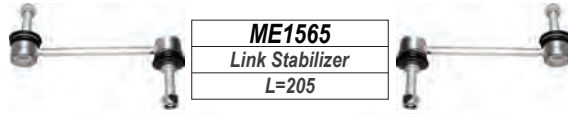

**ME1814**  
Upper Control Arm Bush



**ME1726**  
Upper Control Arm

**ME2121**  
Lower Control Arm Bush

**ME2122**  
Lower Control Arm Bush

**ME1727**  
Upper Control Arm

**ME2121**  
Lower Control Arm Bush

**ME1921**  
Lower Ball Joint  
(Ø19.3)



**ME2065**  
Lower Control Arm



**ME2066**  
Lower Control Arm

**ME1921**  
Lower Ball Joint  
(Ø19.3)



**ME2141 / ME2150**  
Lower Control Arm Bush



W251 SERIES

REAR

**ME1922**  
Lower Ball Joint  
(Ø19.3)



**ME1535**  
Link Stabilizer  
L=117

**ME1922**  
Lower Ball Joint  
(Ø19.3)



**ME2934**  
Bush



**ME2931**  
Bush



**ME2934**  
Bush

**ME2639**  
Lateral Link



**ME2640**  
Lateral Link





**MERCEDES**

W638 SERIES

FRONT

Year

VITO

1996-2004

**ME1043**  
Outer Tie Rod End  
(Ø16.97\*Ø20.2/M16\*1.5)



**ME1339**  
Outer Tie Rod End Set  
(Ø16.97\*Ø20.2/M16\*1.5)

**ME1418**  
Rack End  
(16\*1.5/16\*1.5/336)

**ME1043**  
Outer Tie Rod End  
(Ø16.97\*Ø20.2/M16\*1.5)

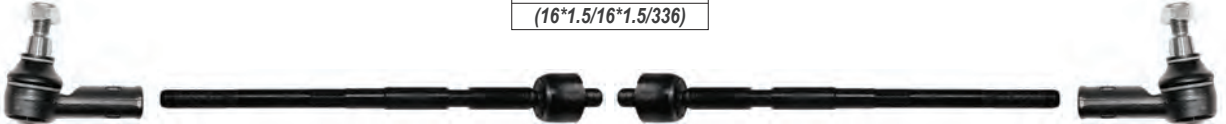

**ME1566 / ME1567**  
Link Stabilizer  
L=250



**ME1568 / ME1569**  
Link Stabilizer  
L=230



**ME2142**  
Lower Control Arm Bush



**ME1927**  
Lower Ball Joint  
(Ø19.3)

**ME1927**  
Lower Ball Joint  
(Ø19.3)

**ME2067**  
Lower Control Arm

**ME2068**  
Lower Control Arm

**ME2143**  
Lower Control Arm Bush



**ME2820**  
Stabilizer Bar Bush  
ID:13.5



**ME2821**  
Stabilizer Bar Bush  
ID:24

W638 SERIES

REAR

**ME1570**  
Link Stabilizer  
L=105



LEFT

RIGHT

**MERCEDES**

W639 SERIES

FRONT

VITO. VIANO

Year

2004-2010

**ME1340**  
Outer Tie Rod End Set  
(Ø16.2\*Ø21/M16\*1.5)



**ME1044**  
Outer Tie Rod End  
(Ø16.2\*Ø21/M16\*1.5)



**ME1419**  
Rack End  
(16\*1.5/16\*1.5/289)



**ME1045**  
Outer Tie Rod End  
(Ø16.2\*Ø21/M16\*1.5)



**ME1571 / ME1572**  
Link Stabilizer  
L=280



**ME1928**  
Lower Ball Joint  
(Ø22)



**ME2143**  
Lower Control Arm Bush



**ME1928**  
Lower Ball Joint  
(Ø22)



**ME2069**  
Lower Control Arm

**ME2070**  
Lower Control Arm

**ME2837**  
Shock Mounting



**ME2837**  
Shock Mounting



**ME2838**  
Shock Mounting



**ME2838**  
Shock Mounting



W639 SERIES

REAR

**ME2661**  
Lateral Link



LEFT

RIGHT

**MERCEDES**

W639 SERIES

FRONT

VITO. VIANO

Year

2011-2015

**ME1340**  
Outer Tie Rod End Set  
(Ø16.2\*Ø21/M16\*1.5)



**ME1044**  
Outer Tie Rod End  
(Ø16.2\*Ø21/M16\*1.5)



**ME1419**  
Rack End  
(16\*1.5/16\*1.5/289)



**ME1045**  
Outer Tie Rod End  
(Ø16.2\*Ø21/M16\*1.5)



**ME1571 / ME1572**  
Link Stabilizer  
L=280



**ME2146**  
Lower Control Arm Bush

**ME1928**  
Lower Ball Joint  
(Ø22)



**ME2071**  
Lower Control Arm



**ME2072**  
Lower Control Arm

**ME1928**  
Lower Ball Joint  
(Ø22)



**ME2144 / ME2145**  
Lower Control Arm Bush



W639 SERIES

REAR

**ME2661**  
Lateral Link



LEFT

RIGHT

**MERCEDES**

W447 SERIES

FRONT

VITO. V200. V220. V250

Year

2015-

**ME1046**  
Outer Tie Rod End  
(Ø16.7\*Ø21/M16\*1.5)

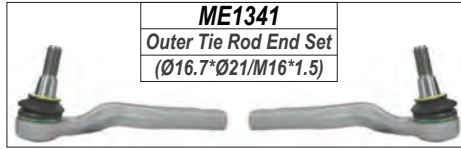

**ME1341**  
Outer Tie Rod End Set  
(Ø16.7\*Ø21/M16\*1.5)

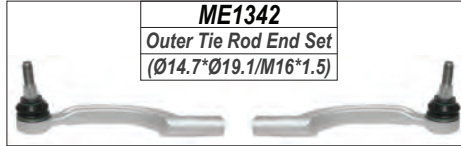

**ME1342**  
Outer Tie Rod End Set  
(Ø14.7\*Ø19.1/M16\*1.5)

**ME1047**  
Outer Tie Rod End  
(Ø16.7\*Ø21/M16\*1.5)



**ME1048**  
Outer Tie Rod End  
(Ø14.7\*Ø19.1/M16\*1.5)



**ME1420**  
Rack End  
(16\*1.5/16\*1.5/264)

**ME1049**  
Outer Tie Rod End  
(Ø14.7\*Ø19.1/M16\*1.5)



**ME1573 / ME1574**  
Link Stabilizer  
L=362



**ME1575 / ME1576**  
Link Stabilizer  
L=362



**ME2073**  
Lower Control Arm

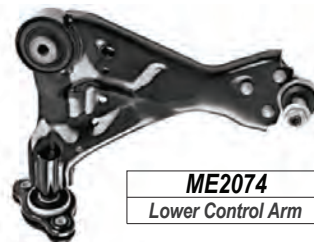

**ME2074**  
Lower Control Arm

**ME1929**  
Lower Ball Joint  
(Ø16)



**ME1929**  
Lower Ball Joint  
(Ø16)



**ME2075**  
Lower Control Arm



**ME2076**  
Lower Control Arm

**LEFT**

**RIGHT**

**MERCEDES**

W903 SERIES

FRONT

SPRINTER

Year

1995-2006

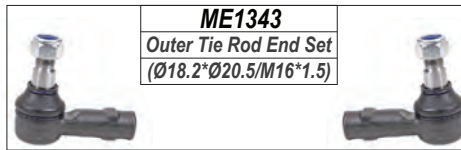

**ME1343**  
Outer Tie Rod End Set  
(Ø18.2\*Ø20.5/M16\*1.5)

**ME1050**  
Outer Tie Rod End  
(Ø18.2\*Ø20.5/M16\*1.5)

**ME1050**  
Outer Tie Rod End  
(Ø18.2\*Ø20.5/M16\*1.5)

**ME1421**  
Rack End  
(16\*1.5/16\*1.5/385)

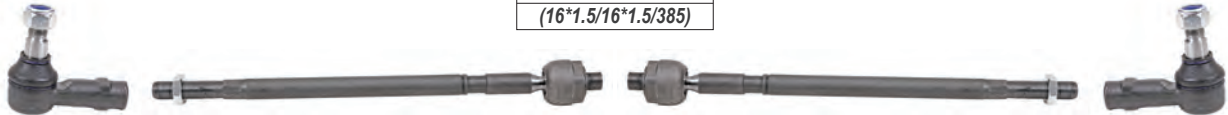

**ME1577 / ME1578**  
Link Stabilizer  
L=128.5

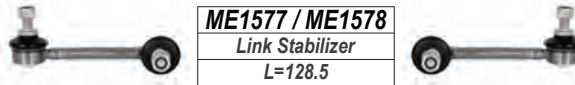

**ME1579 / ME1580**  
Link Stabilizer  
L=115

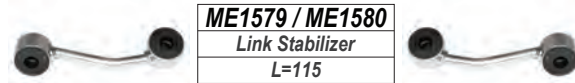

**ME2147**  
Lower Control Arm Bush



**ME1930**  
Lower Ball Joint  
(Ø23.5)

**ME1930**  
Lower Ball Joint  
(Ø23.5)

**ME2077**  
Lower Control Arm

**ME2078**  
Lower Control Arm

**ME2810**  
Stabilizer Bar Bush  
ID:13.5 OD:26 W:20



**ME2811**  
Stabilizer Bar Bush  
ID:22 W:31



**ME2812**  
Stabilizer Bar Bush  
ID:33 W:50.5



**ME2813**  
Stabilizer Bar Bush  
ID:27 W:54



**ME2814**  
Stabilizer Bar Bush  
ID:27 W:38



**ME2815**  
Shock Mounting



**ME2815**  
Shock Mounting



**ME2826**  
Shock Mounting



**ME2826**  
Shock Mounting



LEFT

RIGHT



**MERCEDES**

**W903 SERIES**

**REAR**

**SPRINTER**

*Year*

**1995-2006**

**ME2951**

Bush



**ME1581**

Link Stabilizer

L=94.5

**ME1581**

Link Stabilizer

L=94.5

**ME2951**

Bush



**ME1582**

Link Stabilizer

L=245.5

**ME1582**

Link Stabilizer

L=245.5

**ME2951**

Bush



**ME1583**

Link Stabilizer

L=302

**ME1583**

Link Stabilizer

L=302

**ME2952**

Stabilizer Bar Bush

ID:23 OD:35



**ME2953**

Stabilizer Bar Bush

ID:12.3 OD:38.7



**ME2954**

Stabilizer Bar Bush

ID:12.2 OD:38 W:134



**ME2959**

Stabilizer Bar Bush

ID:18 OD:32 W:31



**LEFT**

**RIGHT**

**MERCEDES**

W906 SERIES

FRONT

SPRINTER

Year

2006-

**ME1051**  
Outer Tie Rod End  
(Ø16.85\*Ø21/M16\*1.5)

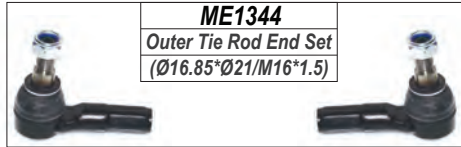

**ME1344**  
Outer Tie Rod End Set  
(Ø16.85\*Ø21/M16\*1.5)

**ME1422**  
Rack End  
(18\*1.5/16\*1.5/401)

**ME1051**  
Outer Tie Rod End  
(Ø16.85\*Ø21/M16\*1.5)



**ME1584 / ME1585**  
Link Stabilizer  
L=137.5

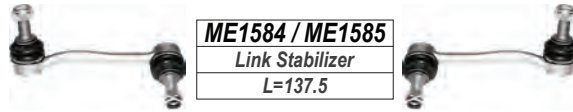

**ME2148**  
Lower Control Arm Bush



**ME1931**  
Lower Ball Joint  
(Ø21.8)



**ME1931**  
Lower Ball Joint  
(Ø21.8)



**ME2079**  
Lower Control Arm

**ME2080**  
Lower Control Arm

**ME2149**  
Lower Control Arm Bush

**ME2822**  
Stabilizer Bar Bush  
ID:24 W:45



**ME2823**  
Stabilizer Bar Bush  
ID:20 W:45



**ME2959**  
Stabilizer Bar Bush  
ID:20 W:52.5



**ME2960**  
Stabilizer Bar Bush  
ID:15.5 W:52.5



**ME2825**  
Shock Mounting



**ME2825**  
Shock Mounting



W906 SERIES

REAR

**ME2955**  
Bush



**ME1586**  
Link Stabilizer  
L=212

**ME1586**  
Link Stabilizer  
L=212

**ME2824**  
Stabilizer Bar Bush



LEFT

RIGHT

## MINI

COOPER- S.S-ONE FRONT

R50.R52.R53

Year

2001-2007

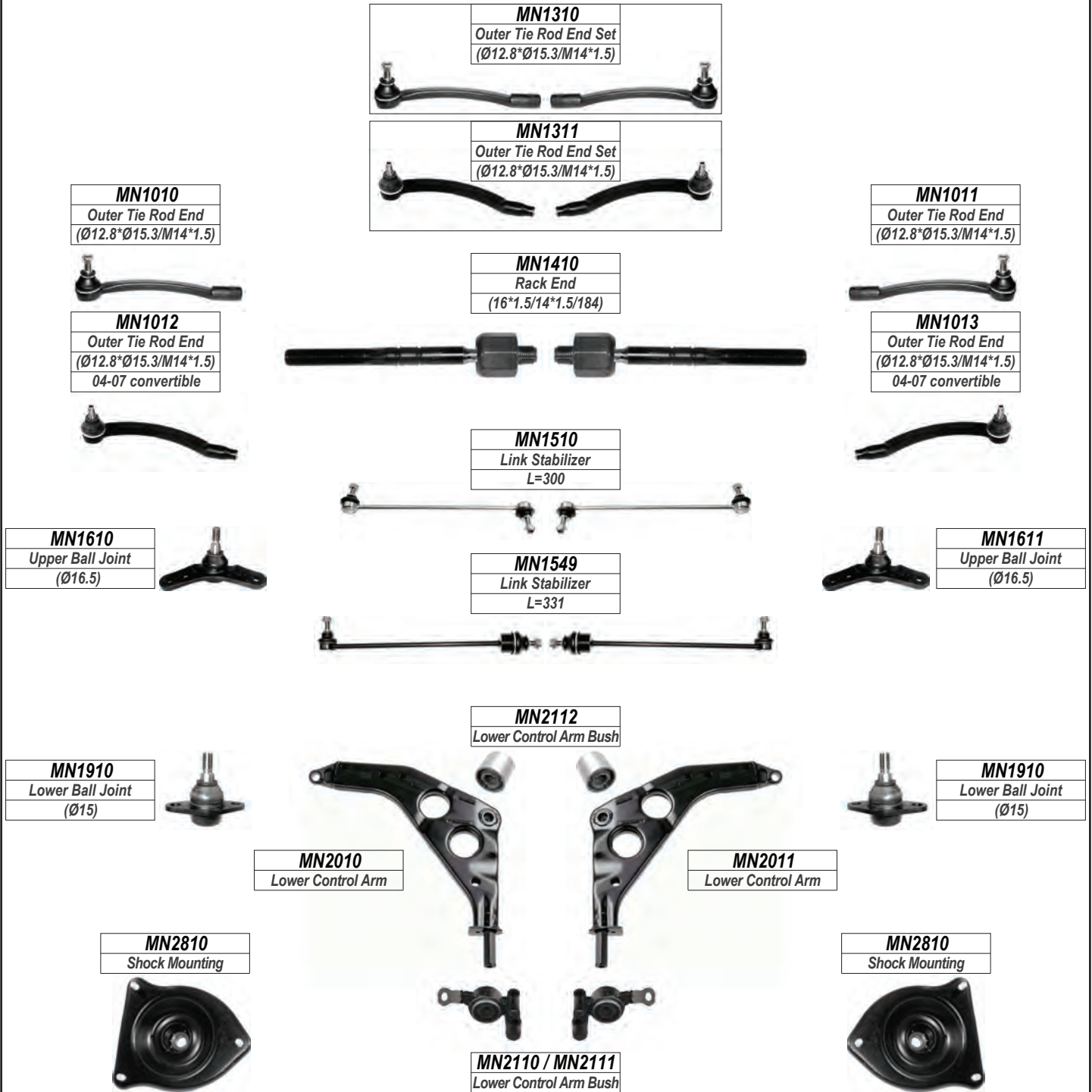

## COOPER- S.S-ONE REAR



LEFT

RIGHT

**MINI**

**COOPER.S.ONE FRONT  
CLUBMAN.JOHN COOPER**

**F55. F56. F57**

**Year**

**2007-**

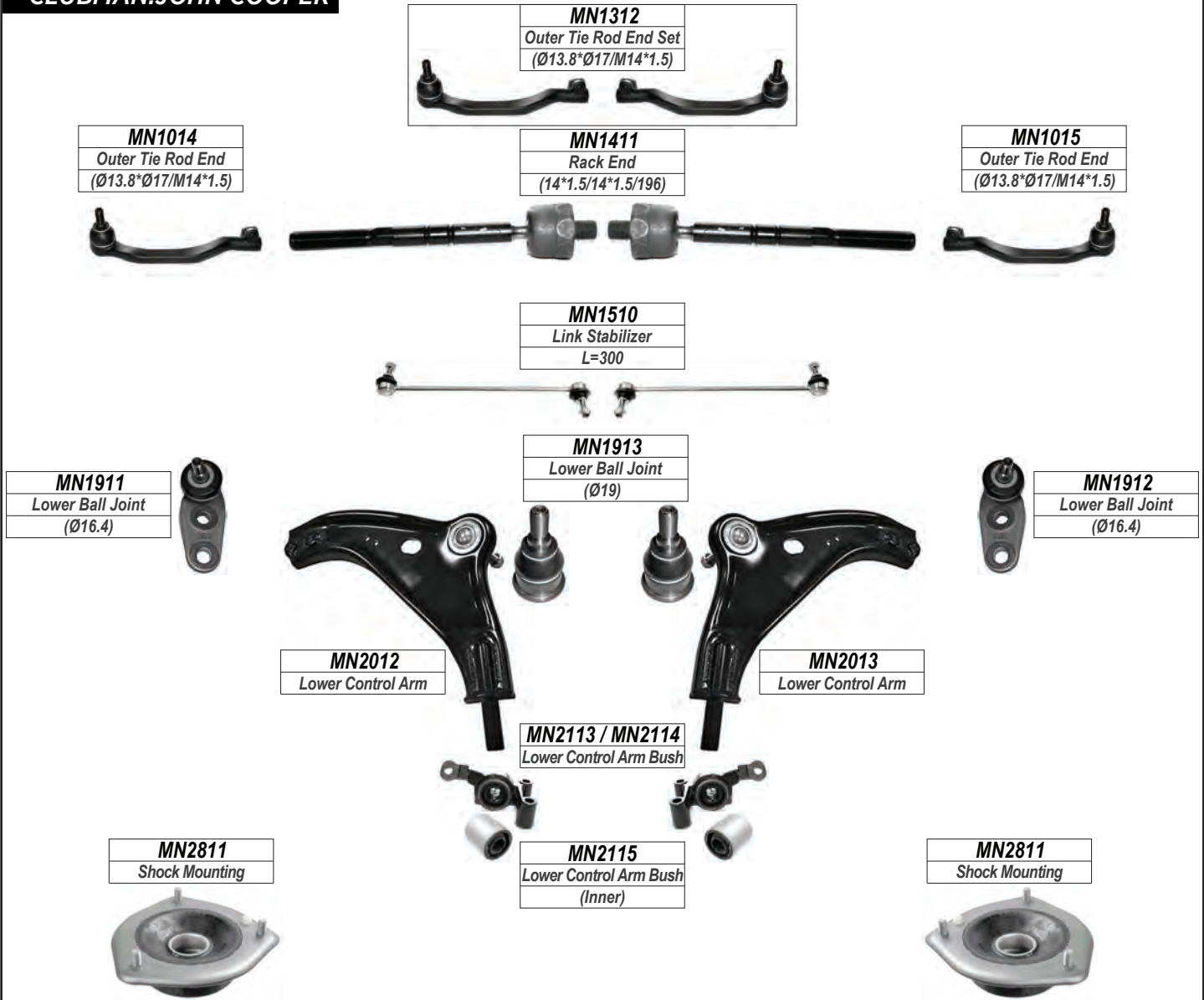

**COOPER.S.ONE REAR  
CLUBMAN.JOHN COOPER**



**LEFT**

**RIGHT**

**MINI**

**COOPER.S.ONE FRONT  
CLUBMAN.JOHN COOPER**

**F55. F56. F57**

**Year**

**2014-**

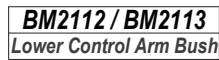
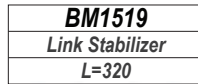
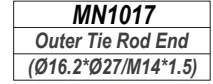
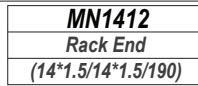
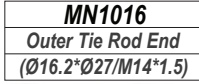

**LEFT**

**RIGHT**



**MINI**

**COUNTRYMAN. FRONT**  
**PACEMAN**

**R60. R61**

*Year*

**2010-**



**MN1314**  
Outer Tie Rod End Set  
(Ø12.65\*Ø16.9/M14\*1.5)



**MN1315**  
Outer Tie Rod End Set  
(Ø13.6\*Ø16.9/M14\*1.5)

**MN1018**  
Outer Tie Rod End  
(Ø12.65\*Ø16.9/M14\*1.5)



**MN1411**  
Rack End  
(14\*1.5/14\*1.5/196)



**MN1019**  
Outer Tie Rod End  
(Ø12.65\*Ø16.9/M14\*1.5)



**MN1020**  
Outer Tie Rod End  
(Ø13.6\*Ø16.9/M14\*1.5)



**MN1021**  
Outer Tie Rod End  
(Ø13.6\*Ø16.9/M14\*1.5)



**MN1513 / MN1514**  
Link Stabilizer  
L=292

**MN1914**  
Lower Ball Joint  
(Ø16.7)



**MN1914**  
Lower Ball Joint  
(Ø16.7)



**MN2014**  
Lower Control Arm



**MN2015**  
Lower Control Arm

**MN2116**  
Lower Control Arm Bush



**MN2117**  
Lower Control Arm Bush

**MN2115**  
Lower Control Arm Bush  
(Inner)

**COUNTRYMAN(R60) REAR**  
**PACEMAN(R61)**

**MN1515 / MN1516**  
Link Stabilizer  
L=155



**LEFT**

**RIGHT**

**mitsubishi**

ASX

FRONT

ALL MODEL

Year

2011-

**CI1029**  
Outer Tie Rod End  
(Ø13.45\*Ø15.1/M14\*1.5)

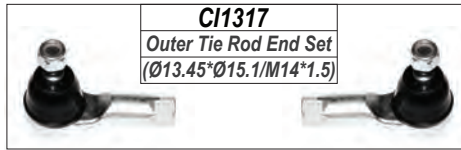

**CI1317**  
Outer Tie Rod End Set  
(Ø13.45\*Ø15.1/M14\*1.5)

**CI1029**  
Outer Tie Rod End  
(Ø13.45\*Ø15.1/M14\*1.5)



**CI1420**  
Rack End  
(14\*1.5/14\*1.5/341)



**CI1516**  
Link Stabilizer  
L=265



**CI2121**  
Lower Control Arm Bush



**CI1910**  
Lower Ball Joint  
(Ø20)



**CI1910**  
Lower Ball Joint  
(Ø20)



**CI2020**  
Lower Control Arm



**CI2021**  
Lower Control Arm



**CI2120**  
Lower Control Arm Bush



**MI2810**  
Shock Mounting



**MI2810**  
Shock Mounting



LEFT

RIGHT

**MITSUBISHI**

COLT

FRONT

2WD

Year

1994-1998

**MI1310**

Outer Tie Rod End Set  
(Ø12.5\*Ø13.5/M14\*1.5)

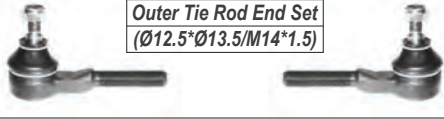

**MI1311**

Inner Tie Rod End Set  
(Ø12.18\*Ø14/M14\*1.5)



**MI1011**

Outer Tie Rod End  
(Ø12.5\*Ø13.5/M14\*1.5)



**MI1111 / MI1112**

Inner Tie Rod End  
(Ø12.18\*Ø14/M14\*1.5)



**MI1011**

Outer Tie Rod End  
(Ø12.5\*Ø13.5/M14\*1.5)



**MI1610**

Upper Ball Joint  
(Ø16)



**MI1810**

Upper Control Arm Bush

**MI1610**

Upper Ball Joint  
(Ø16)



**MI1710**

Upper Control Arm

**MI1711**

Upper Control Arm

**HY1922**

Lower Ball Joint  
(Ø19.5)



**MI2110**

Lower Control Arm Bush



**HY1922**

Lower Ball Joint  
(Ø19.5)



**MI2010**

Lower Control Arm

**MI2011**

Lower Control Arm

**MI2511**

Pitman Arm



**MI2411**

Idler Arm



LEFT

RIGHT

**MITSUBISHI**

COLT

FRONT

4WD

Year

1994-1998

**MI2210**

Center Rod



**MI1312**

Outer Tie Rod End Set  
(Ø13.6\*Ø15.8/M16\*1.5)

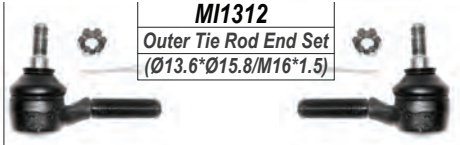

**MI1313**

Inner Tie Rod End Set  
(Ø13.7\*Ø16.2/M16\*1.5)



**MI1012**

Outer Tie Rod End  
(Ø13.6\*Ø15.8/M16\*1.5)



**MI1113**

Inner Tie Rod End  
(Ø13.7\*Ø16.2/M16\*1.5)



**MI1012**

Outer Tie Rod End  
(Ø13.6\*Ø15.8/M16\*1.5)



**MI1610**

Upper Ball Joint  
(Ø16)



**MI1113**

Inner Tie Rod End  
(Ø13.7\*Ø16.2/M16\*1.5)



**MI1610**

Upper Ball Joint  
(Ø16)



**MI1712**

Upper Control Arm



**MI1713**

Upper Control Arm



**MI1910**

Lower Ball Joint  
(Ø19.5)



**MI2111**

Lower Control Arm Bush



**MI1910**

Lower Ball Joint  
(Ø19.5)



**MI2512**

Pitman Arm



**MI2012**

Lower Control Arm



**MI2013**

Lower Control Arm



**MI2412**

Idler Arm



**LEFT**

**RIGHT**

**MITSUBISHI**

COLT

FRONT

4WD

Year

1998-2009

**MI1314**

Outer Tie Rod End Set  
(Ø13.65\*Ø15.9/M16\*1.5)

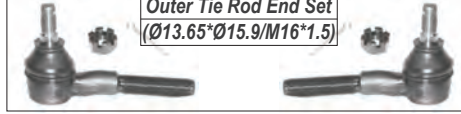

**MI1315**

Inner Tie Rod End Set  
(Ø13.6\*Ø15.85/M16\*1.5)

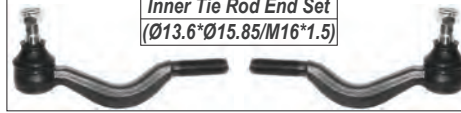

**MI1010**

Outer Tie Rod End  
(Ø13.65\*Ø15.9/M16\*1.5)



**MI1110**

Inner Tie Rod End  
(Ø13.6\*Ø15.85/M16\*1.5)



**MI1010**

Outer Tie Rod End  
(Ø13.65\*Ø15.9/M16\*1.5)



**MI1611**

Upper Ball Joint  
(Ø16)



**MI1714**

Upper Control Arm



**MI1715**

Upper Control Arm

**MI1611**

Upper Ball Joint  
(Ø16)



**MI1612**

Upper Ball Joint  
(Ø16)



**MI1612**

Upper Ball Joint  
(Ø16)



**MI1911**

Lower Ball Joint  
(Ø19.5)



**MI2014**

Lower Control Arm



**MI2111**

Lower Control Arm Bush



**MI2015**

Lower Control Arm

**MI1912**

Lower Ball Joint  
(Ø19.5)



**MI2510**

Pitman Arm



**MI2410**

Idler Arm



**LEFT**

**RIGHT**



**MITSUBISHI**

COLT

FRONT

LDW STANDARD BODY

Year

1998-2009

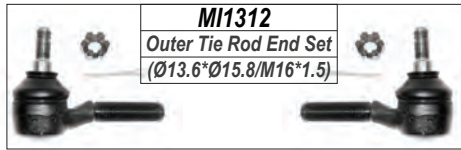

**MI1312**  
Outer Tie Rod End Set  
(Ø13.6\*Ø15.8/M16\*1.5)



**MI1316**  
Inner Tie Rod End Set  
(Ø13.7\*Ø16.2/M16\*1.5)

**MI1012**  
Outer Tie Rod End  
(Ø13.6\*Ø15.8/M16\*1.5)



**MI1114**  
Inner Tie Rod End  
(Ø13.7\*Ø16.2/M16\*1.5)



**MI1012**  
Outer Tie Rod End  
(Ø13.6\*Ø15.8/M16\*1.5)



**MI1716**  
Upper Control Arm

**MI1717**  
Upper Control Arm

**MI1610**  
Upper Ball Joint  
(Ø16)



**MI1610**  
Upper Ball Joint  
(Ø16)



**HY1922**  
Lower Ball Joint  
(Ø19.67)



**MI2114**  
Lower Control Arm Bush



**MI2016**  
Lower Control Arm

**MI2017**  
Lower Control Arm

**HY1922**  
Lower Ball Joint  
(Ø19.67)



**MI2413**  
Pitman Arm



**MI2513**  
Idler Arm



**LEFT**

**RIGHT**

**MITSUBISHI**

COLT

FRONT

LDV HI-LINE RAISED BODY 4X4

Year

1998-2009

**MI1314**

Outer Tie Rod End Set  
(Ø13.65\*Ø15.9/M16\*1.5)

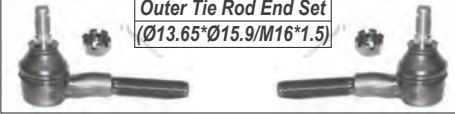

**MI1315**

Inner Tie Rod End Set  
(Ø13.6\*Ø15.85/M16\*1.5)

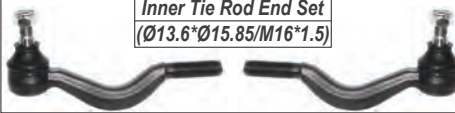

**MI1010**

Outer Tie Rod End  
(Ø13.65\*Ø15.9/M16\*1.5)



**MI1110**

Inner Tie Rod End  
(Ø13.6\*Ø15.85/M16\*1.5)



**MI1010**

Outer Tie Rod End  
(Ø13.65\*Ø15.9/M16\*1.5)



**MI1610**

Upper Ball Joint  
(Ø16)



**MI1716**

Upper Control Arm

**MI1717**

Upper Control Arm

**MI1610**

Upper Ball Joint  
(Ø16)



**MI1911**

Lower Ball Joint  
(Ø19.45)



**MI2014**

Lower Control Arm



**MI2111**

Lower Control Arm Bush



**MI2015**

Lower Control Arm

**MI1912**

Lower Ball Joint  
(Ø19.45)



**MI2510**

Pitman Arm



**MI2410**

Idler Arm



LEFT

RIGHT

**MITSUBISHI**

L300

FRONT

P/VAN.STARWAGON

Year

1982-2002

**MI1317**  
Outer Tie Rod End Set  
(Ø13.4\*Ø15.1/M14\*1.5)

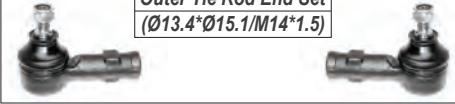

**MI1318**  
Inner Tie Rod End Set  
(Ø13.3\*Ø15/M14\*1.5)

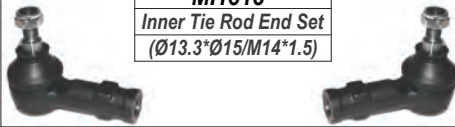

**MI1013**  
Outer Tie Rod End  
(Ø13.4\*Ø15.1/M14\*1.5)



**MI1115**  
Inner Tie Rod End  
(Ø13.3\*Ø15/M14\*1.5)



**MI1013**  
Outer Tie Rod End  
(Ø13.4\*Ø15.1/M14\*1.5)



**MI1610**  
Upper Ball Joint  
(Ø16)



**MI1718**  
Upper Control Arm

**MI1718**  
Upper Control Arm

**MI1610**  
Upper Ball Joint  
(Ø16)



**HY1922**  
Lower Ball Joint  
(Ø19.67)



**HY1922**  
Lower Ball Joint  
(Ø19.67)



**MI2514**  
Idler Arm



**LEFT**

**RIGHT**

**mitsubishi**

LANCER

FRONT

CS-A

Year

2003-

**MI1014**  
Outer Tie Rod End  
(Ø13.5°Ø15/M12\*1.25)



**MI1410**  
Rack End  
(16\*1.5/12\*1.25/311)



**MI1014**  
Outer Tie Rod End  
(Ø13.5°Ø15/M12\*1.25)

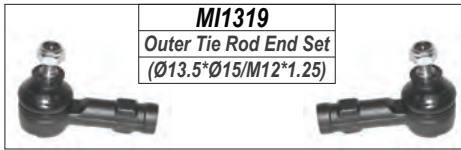

**MI1319**  
Outer Tie Rod End Set  
(Ø13.5°Ø15/M12\*1.25)



**MI1510**  
Link Stabilizer  
L=131.5



**CI2121**  
Lower Control Arm Bush



**MI2018**  
Lower Control Arm

**MI2019**  
Lower Control Arm

**CI2120**  
Lower Control Arm Bush



**MI2811**  
Shock Mounting



**MI2811**  
Shock Mounting



LANCER

REAR

**MI1511**  
Link Stabilizer  
L=116



**MI2020**  
Lower Control Arm



**MI2021**  
Lower Control Arm

LEFT

RIGHT

**MITSUBISHI**

LANCER

FRONT

SPORTBACK

Year

2008-

**CI1029**  
Outer Tie Rod End  
(Ø13.45\*Ø15.1/M14\*1.5)

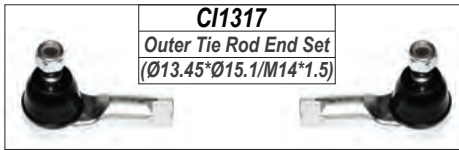

**CI1317**  
Outer Tie Rod End Set  
(Ø13.45\*Ø15.1/M14\*1.5)

**CI1420**  
Rack End  
(14\*1.5/14\*1.5/341)

**CI1029**  
Outer Tie Rod End  
(Ø13.45\*Ø15.1/M14\*1.5)



**CI1516**  
Link Stabilizer  
L=265



**CI2121**  
Lower Control Arm Bush



**CI1910**  
Lower Ball Joint  
(Ø20)



**CI2020**  
Lower Control Arm

**CI2021**  
Lower Control Arm

**CI1910**  
Lower Ball Joint  
(Ø20)



**CI2120**  
Lower Control Arm Bush



LANCER

REAR

**DO1511 / DO1512**  
Link Stabilizer  
L=80



**MI2610**  
Lateral Link



**MI2610**  
Lateral Link

LEFT

RIGHT



**mitsubishi**

**OUTLANDER**

**FRONT**

Year

2003-2008

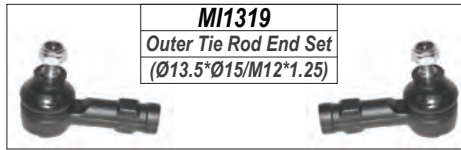

**MI1014**  
Outer Tie Rod End  
(Ø13.5\*Ø15/M12\*1.25)

**MI1410**  
Rack End  
(16\*1.5/12\*1.25/311)

**MI1014**  
Outer Tie Rod End  
(Ø13.5\*Ø15/M12\*1.25)



**MI2022**  
Lower Control Arm

**MI2023**  
Lower Control Arm

**LEFT**

**RIGHT**

**MITSUBISHI**

**OUTLANDER**

**FRONT**

Year

2006-2014

II

**CI1317**

Outer Tie Rod End Set  
(Ø13.45\*Ø15.1/M14\*1.5)

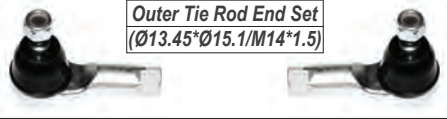

**CI1029**

Outer Tie Rod End  
(Ø13.45\*Ø15.1/M14\*1.5)



**CI1029**

Outer Tie Rod End  
(Ø13.45\*Ø15.1/M14\*1.5)



**CI1420**

Rack End  
(14\*1.5/14\*1.5/341)



**MI1411**

Rack End  
(14\*1.5/14\*1.5/324)



**CI1516**

Link Stabilizer  
L=265



**CI2121**

Lower Control Arm Bush



**CI1910**

Lower Ball Joint  
(Ø20)



**CI1910**

Lower Ball Joint  
(Ø20)



**CI2020**

Lower Control Arm



**CI2021**

Lower Control Arm

**MI2810**

Shock Mounting



**CI2120**

Lower Control Arm Bush



**MI2810**

Shock Mounting



**OUTLANDER**

**REAR**

**DO1511 / DO1512**

Link Stabilizer  
L=80



**LEFT**

**RIGHT**

**MITSUBISHI**

PAJERO

FRONT

Year

1983-1994

**MI2210**

Center Rod



**MI1312**

Outer Tie Rod End Set  
(Ø13.6\*Ø15.8/M16\*1.5)

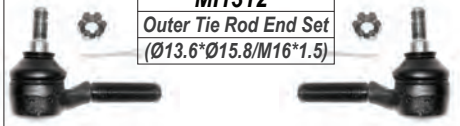

**MI1313**

Inner Tie Rod End Set  
(Ø13.7\*Ø16.2/M16\*1.5)



**MI1012**

Outer Tie Rod End  
(Ø13.6\*Ø15.8/M16\*1.5)



**MI1113**

Inner Tie Rod End  
(Ø13.7\*Ø16.2/M16\*1.5)



**MI1012**

Outer Tie Rod End  
(Ø13.6\*Ø15.8/M16\*1.5)



**MI1610**

Upper Ball Joint  
(Ø16)



**MI1712**

Upper Control Arm



**MI1713**

Upper Control Arm

**MI1610**

Upper Ball Joint  
(Ø16)



**MI1910**

Lower Ball Joint  
(Ø19.5)



**MI2012**

Lower Control Arm

**MI2111**

Lower Control Arm Bush



**MI2013**

Lower Control Arm

**MI1910**

Lower Ball Joint  
(Ø19.5)



**MI2512**

Pitman Arm



**MI2414**

Idler Arm



**LEFT**

**RIGHT**

**MITSUBISHI**

PAJERO

FRONT

II

Year

1990-2000

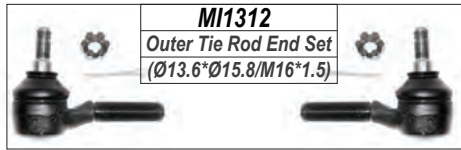

**MI1312**  
Outer Tie Rod End Set  
(Ø13.6\*Ø15.8/M16\*1.5)



**MI1313**  
Inner Tie Rod End Set  
(Ø13.7\*Ø16.2/M16\*1.5)

**MI1012**  
Outer Tie Rod End  
(Ø13.6\*Ø15.8/M16\*1.5)



**MI1113**  
Inner Tie Rod End  
(Ø13.7\*Ø16.2/M16\*1.5)



**MI1012**  
Outer Tie Rod End  
(Ø13.6\*Ø15.8/M16\*1.5)



**MI1512 / MI1513**  
Link Stabilizer  
L=78

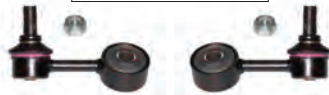

**MI1612**  
Upper Ball Joint  
(Ø16)



**MI1612**  
Upper Ball Joint  
(Ø16)



**MI1611**  
Upper Ball Joint  
(Ø16)



**MI1611**  
Upper Ball Joint  
(Ø16)



**MI1714**  
Upper Control Arm



**MI1715**  
Upper Control Arm



**MI1911**  
Lower Ball Joint  
(Ø19.45)



**MI1912**  
Lower Ball Joint  
(Ø19.45)



**MI2014**  
Lower Control Arm



**MI2015**  
Lower Control Arm



**MI2111**  
Lower Control Arm Bush



**MI2515**  
Pitman Arm



**MI2415**  
Idler Arm



LEFT

RIGHT

**MITSUBISHI**

**PAJERO**

**FRONT**

Year

2000-2007

III.IV

**MI1015**  
Outer Tie Rod End  
(Ø13.65\*Ø15.9/M16\*1.5)



**MI1017**  
Outer Tie Rod End  
(Ø13.7\*Ø16.2/M16\*1.5)

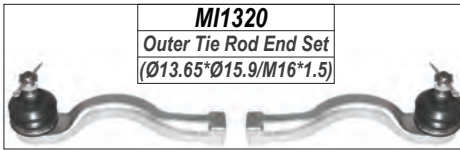

**MI1320**  
Outer Tie Rod End Set  
(Ø13.65\*Ø15.9/M16\*1.5)



**MI1321**  
Outer Tie Rod End Set  
(Ø13.7\*Ø16.2/M16\*1.5)

**MI1412**  
Rack End  
(16\*1.5/16\*1.5/206)



**MI1016**  
Outer Tie Rod End  
(Ø13.5\*Ø15/M12\*1.25)



**MI1018**  
Outer Tie Rod End  
(Ø13.7\*Ø16.2/M16\*1.5)



**MI1514 / MI1515**  
Link Stabilizer  
L=78

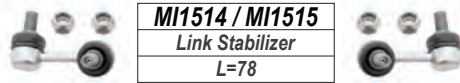

**MI1516 / MI1517**  
Link Stabilizer  
L=78

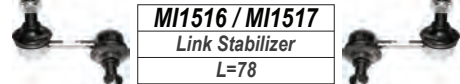

**MI1612**  
Upper Ball Joint  
(Ø16)



**MI1611**  
Upper Ball Joint  
(Ø16)



**MI1719**  
Upper Control Arm



**MI1720**  
Upper Control Arm



**MI1612**  
Upper Ball Joint  
(Ø16)



**MI1611**  
Upper Ball Joint  
(Ø16)

**MI2112**  
Lower Control Arm Bush



**MI1913**  
Lower Ball Joint  
(Ø19.5)



**MI1913**  
Lower Ball Joint  
(Ø19.5)

**MI2024**  
Lower Control Arm

**MI2025**  
Lower Control Arm

**MI2113**  
Lower Control Arm Bush

**PAJERO**

**REAR**

**MI1518 / MI1519**  
Link Stabilizer  
L=115



**MI1914**  
Lower Ball Joint  
(Ø19.2)



**MI1914**  
Lower Ball Joint  
(Ø19.2)



**LEFT**

**RIGHT**



**MITSUBISHI**

TRITON

FRONT

ALL MODEL

Year

2007-

**MI1015**  
Outer Tie Rod End  
(Ø13.65\*Ø15.9/M16\*1.5)



**MI1320**  
Outer Tie Rod End Set  
(Ø13.65\*Ø15.9/M16\*1.5)

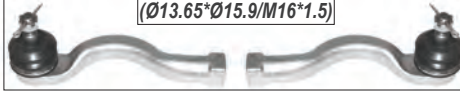

**MI1412**  
Rack End  
(16\*1.5/16\*1.5/206)



**MI1016**  
Outer Tie Rod End  
(Ø13.5\*Ø15/M12\*1.25)



**MI1514 / MI1515**  
Link Stabilizer  
L=78



**MI1516 / MI1517**  
Link Stabilizer  
L=78



**MI1612**  
Upper Ball Joint  
(Ø16)



**MI1721**  
Upper Control Arm



**MI1722**  
Upper Control Arm

**MI1612**  
Upper Ball Joint  
(Ø16)



**MI1913**  
Lower Ball Joint  
(Ø19.5)



**MI2026**  
Lower Control Arm



**MI1913**  
Lower Ball Joint  
(Ø19.5)

**MI2027**  
Lower Control Arm

PAJERO

REAR

**MI1518 / MI1519**  
Link Stabilizer  
L=115



**MI1914**  
Lower Ball Joint  
(Ø19.2)



**MI1914**  
Lower Ball Joint  
(Ø19.2)

LEFT

RIGHT

**NISSAN**

1200.1400.1600.1800j FRONT

BAKKIE.SEDAN

Year

1971-1984

**NI1310**  
Outer Tie Rod End Set  
(Ø11.4\*Ø13.4/M14\*1.5)



**NI1311**  
Inner Tie Rod End Set  
(Ø11.4\*Ø13.4/M14\*1.5)



**NI1024**  
Outer Tie Rod End  
(Ø11.4\*Ø13.4/M14\*1.5)



**NI1114 / NI1115**  
Inner Tie Rod End  
(Ø11.4\*Ø13.4/M14\*1.5)



**NI1025**  
Outer Tie Rod End  
(Ø11.4\*Ø13.4/M14\*1.5)



**NI1910**  
Lower Ball Joint(1.6\*1.8)  
(Ø15)



**NI1910**  
Lower Ball Joint(1.6\*1.8)  
(Ø15)



**NI1911**  
Lower Ball Joint(1.2\*1.4)  
(Ø15)



**NI1911**  
Lower Ball Joint(1.2\*1.4)  
(Ø15)



**NI1912**  
Lower Ball Joint(1.40Y)  
(Ø15)



**NI1912**  
Lower Ball Joint(1.40Y)  
(Ø15)



**NI2811**  
Shock Mounting



**NI2811**  
Shock Mounting



LEFT

RIGHT

**NISSAN**

680.720

FRONT

D21 4X4.4X2

Year

1980-1988

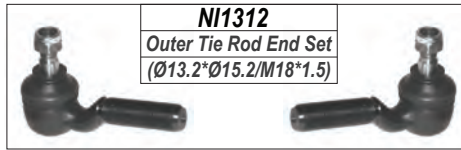

<b>NI1026</b>
<i>Outer Tie Rod End</i>
<i>(Ø13.2*Ø15.2/M18*1.5)</i>



<b>NI1116</b>
<i>Inner Tie Rod End</i>
<i>(Ø13.2*Ø15.2/M18*1.5)</i>



<b>NI1026</b>
<i>Outer Tie Rod End</i>
<i>(Ø13.2*Ø15.2/M18*1.5)</i>



<b>NI1210</b>
<i>Tie Rod Assembly</i>



<b>NI1613</b>
<i>Upper Ball Joint</i>
<i>(Ø16)</i>



<b>NI1613</b>
<i>Upper Ball Joint</i>
<i>(Ø16)</i>



<b>NI1923</b>
<i>Lower Ball Joint</i>
<i>(Ø19.5)</i>



<b>NI1924</b>
<i>Lower Ball Joint</i>
<i>(Ø19.5)</i>



**LEFT**

**RIGHT**

**NISSAN**

720

FRONT

D21 2.2 KINGCAB.4WD

Year

1984-1988

**NI2210**  
Center Rod



<b>NI1010</b>
Outer Tie Rod End (Ø13.3*Ø15.3/M16*1.5)



<b>NI1110</b>
Inner Tie Rod End (Ø13.3*Ø15.3/M16*1.5)



<b>NI1010</b>
Outer Tie Rod End (Ø13.3*Ø15.3/M16*1.5)



<b>NI1613</b>
Upper Ball Joint (Ø16)



<b>NI1613</b>
Upper Ball Joint (Ø16)

<b>NI1913</b>
Lower Ball Joint (Ø19.6)



<b>NI1913</b>
Lower Ball Joint (Ø19.6)

<b>NI2410</b>
Idler Arm



**LEFT**

**RIGHT**

**NISSAN**

**1 TONNER  
HARDBODY/SANI**

**FRONT**

**AW/D22 4X2**

*Year*

**1988-1998**

**NI2212**  
Center Rod

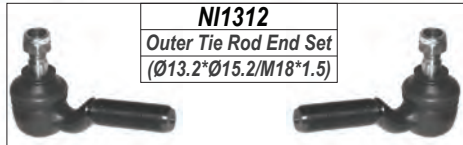

**NI1312**  
Outer Tie Rod End Set  
(Ø13.2\*Ø15.2/M18\*1.5)



**NI1313**  
Inner Tie Rod End Set  
(Ø13.2\*Ø15.2/M18\*1.5)

**NI1026**  
Outer Tie Rod End  
(Ø13.2\*Ø15.2/M18\*1.5)



**NI1116**  
Inner Tie Rod End  
(Ø13.2\*Ø15.2/M18\*1.5)



**NI1026**  
Outer Tie Rod End  
(Ø13.2\*Ø15.2/M18\*1.5)



**NI1510**  
Link Stabilizer  
L=150



**NI1613**  
Upper Ball Joint  
(Ø16)



**NI1710**  
Upper Control Arm



**NI1711**  
Upper Control Arm



**NI1613**  
Upper Ball Joint  
(Ø16)

**NI1925**  
Lower Ball Joint  
(Ø19.7)



**NI2010**  
Lower Control Arm



**NI2011**  
Lower Control Arm



**NI1925**  
Lower Ball Joint  
(Ø19.7)

**NI2413**  
Idler Arm



**NI2510**  
Pitman Arm



**NI2511**  
Pitman Arm



**LEFT**

**RIGHT**



**NISSAN**

1 TONNER  
HARDBODY

FRONT

D22 4WD

Year

1988-1998

**NI2210**

Center Rod



**NI1314**

Outer Tie Rod End Set  
(Ø13.3\*Ø15.3/M16\*1.5)

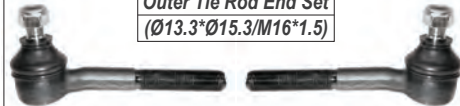

**NI1315**

Inner Tie Rod End Set  
(Ø13.3\*Ø15.3/M16\*1.5)

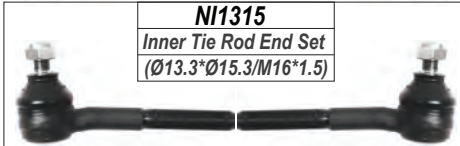

**NI1010**

Outer Tie Rod End  
(Ø13.3\*Ø15.3/M16\*1.5)



**NI1110**

Inner Tie Rod End  
(Ø13.3\*Ø15.3/M16\*1.5)



**NI1010**

Outer Tie Rod End  
(Ø13.3\*Ø15.3/M16\*1.5)



**NI1613**

Upper Ball Joint  
(Ø16)



**NI2145**

Lower Control Arm Bush



**NI1613**

Upper Ball Joint  
(Ø16)



**NI1712**

Upper Control Arm



**NI1713**

Upper Control Arm



**NI1913**

Lower Ball Joint  
(Ø19.6)



**NI2134**

Lower Control Arm Bush



**NI1913**

Lower Ball Joint  
(Ø19.6)



**NI2012**

Lower Control Arm



**NI2013**

Lower Control Arm



**NI2410**

Idler Arm



LEFT

RIGHT

**NISSAN**

**HARDBODY**

**FRONT**

**2WD**

*Year*

**1998-2001**

**NI2213**

Center Rod(M/S)



**NI2214**

Center Rod(P/S)



**NI1316**

Outer Tie Rod End Set  
(Ø14.4\*Ø16.4/M18\*1.5)

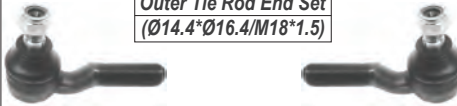

**NI1317**

Inner Tie Rod End Set  
(Ø14.4\*Ø16.4/M18\*1.5)

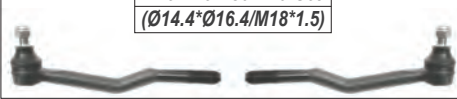

**NI1027**

Outer Tie Rod End  
(Ø14.4\*Ø16.4/M18\*1.5)



**NI1117**

Inner Tie Rod End  
(Ø14.4\*Ø16.4/M18\*1.5)



**NI1027**

Outer Tie Rod End  
(Ø14.4\*Ø16.4/M18\*1.5)



**NI1211**

Tie Rod Assembly



**NI1614**

Upper Ball Joint  
(Ø16.2)



**NI1813**

Upper Control Arm Bush



**NI1614**

Upper Ball Joint  
(Ø16.2)



**NI1714**

Upper Control Arm



**NI1715**

Upper Control Arm



**NI1925**

Lower Ball Joint  
(Ø19.7)



**NI1925**

Lower Ball Joint  
(Ø19.7)



**NI2010**

Lower Control Arm

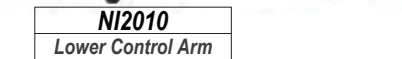

**NI2011**

Lower Control Arm

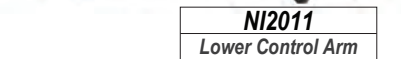

**NI2413**

Idler Arm(M/S)



**NI2411**

Idler Arm(P/S)



**LEFT**

**RIGHT**

**NISSAN**

**HARDBODY/SANI  
NP300**

**FRONT**

**D22/D25 2WD-STD/HI RIDER**

*Year*

**01-08/98-99/08-**

**NI2212**  
Center Rod(Hi-Rider)



**NI2213**  
Center Rod(M/S)



**NI2214**  
Center Rod(P/S)

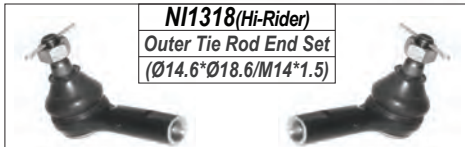

**NI1318(Hi-Rider)**  
Outer Tie Rod End Set  
(Ø14.6\*Ø18.6/M14\*1.5)



**NI1319(Hi-Rider)**  
Inner Tie Rod End Set  
(Ø15\*Ø17/M14\*1.5)

**NI1011(Hi-Rider)**  
Outer Tie Rod End  
(Ø14.6\*Ø18.6/M14\*1.5)



**NI1118(Hi-Rider)**  
Inner Tie Rod End  
(Ø15\*Ø17/M14\*1.5)



**NI1011(Hi-Rider)**  
Outer Tie Rod End  
(Ø14.6\*Ø18.6/M14\*1.5)



**NI1212**  
Tie Rod Assembly

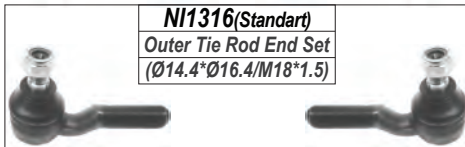

**NI1316(Standart)**  
Outer Tie Rod End Set  
(Ø14.4\*Ø16.4/M18\*1.5)

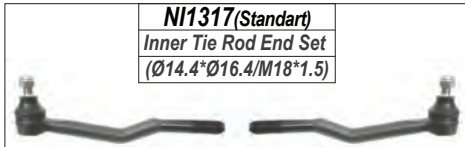

**NI1317(Standart)**  
Inner Tie Rod End Set  
(Ø14.4\*Ø16.4/M18\*1.5)

**NI1027(Standart)**  
Outer Tie Rod End  
(Ø14.4\*Ø16.4/M18\*1.5)



**NI1117(Standart)**  
Inner Tie Rod End  
(Ø14.4\*Ø16.4/M18\*1.5)



**NI1027(Standart)**  
Outer Tie Rod End  
(Ø14.4\*Ø16.4/M18\*1.5)



**NI1211**  
Tie Rod Assembly



**LEFT**

**RIGHT**

**NISSAN**

**HARDBODY/SANI FRONT NP300**

**D22/D25 2WD-STD/HI RIDER**

*Year*

**01-08/98-99/08-**



**NI2413**  
Idler Arm(M/S)



**NI2411**  
Idler Arm(P/S)



**LEFT**

**RIGHT**



**NISSAN**

**HARDBODY/NP300 FRONT**

**4WD**

*Year*

**1998-2010**

**NI2211**  
Center Rod



**NI1318**  
Outer Tie Rod End Set  
(Ø14.6\*Ø18.6/M14\*1.5)

**NI1319**  
Inner Tie Rod End Set  
(Ø15\*Ø17/M14\*1.5)

**NI1011**  
Outer Tie Rod End  
(Ø14.6\*Ø18.6/M14\*1.5)



**NI1118**  
Inner Tie Rod End  
(Ø15\*Ø17/M14\*1.5)



**NI1011**  
Outer Tie Rod End  
(Ø14.6\*Ø18.6/M14\*1.5)



**NI1212**  
Tie Rod Assembly



**NI1614**  
Upper Ball Joint  
(Ø16.2)



**NI1813**  
Upper Control Arm Bush



**NI1614**  
Upper Ball Joint  
(Ø16.2)



**NI1716**  
Upper Control Arm



**NI1717**  
Upper Control Arm



**NI1914**  
Lower Ball Joint  
(Ø19.7)



**NI2134**  
Lower Control Arm Bush



**NI1914**  
Lower Ball Joint  
(Ø19.7)



**NI2014**  
Lower Control Arm



**NI2412**  
Idler Arm



**NI2015**  
Lower Control Arm

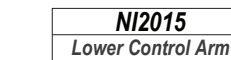

**LEFT**

**RIGHT**



**NISSAN**

ALMERA

FRONT

ALL MODELS

Year

2001-2006

**NI1028**  
Outer Tie Rod End  
(Ø13\*Ø15.5/M14\*1.5)



**NI1320**  
Outer Tie Rod End Set  
(Ø13\*Ø15.5/M14\*1.5)

**NI1410**  
Rack End  
(16\*1.0/14\*1.5/286)

**NI1028**  
Outer Tie Rod End  
(Ø13\*Ø15.5/M14\*1.5)



**NI1029**  
Outer Tie Rod End  
(Ø13\*Ø15.5/M12\*1.25)

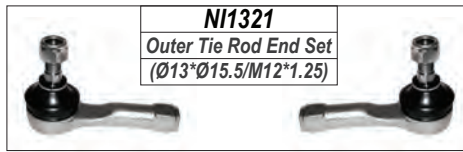

**NI1321**  
Outer Tie Rod End Set  
(Ø13\*Ø15.5/M12\*1.25)

**NI1411**  
Rack End  
(16\*1.0/12\*1.25/285)

**NI1029**  
Outer Tie Rod End  
(Ø13\*Ø15.5/M12\*1.25)

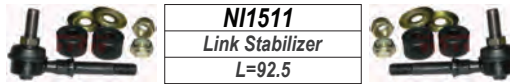

**NI1511**  
Link Stabilizer  
L=92.5

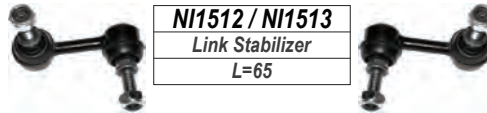

**NI1512 / NI1513**  
Link Stabilizer  
L=65

**NI2810**  
Stabilizer Bar Bush



**NI2810**  
Stabilizer Bar Bush



**NI1926**  
Lower Ball Joint  
(Ø14.75)



**NI2110**  
Lower Control Arm Bush



**NI2016**  
Lower Control Arm

**NI2017**  
Lower Control Arm

**NI1926**  
Lower Ball Joint  
(Ø14.75)



**NI2812**  
Shock Mounting



**NI2812**  
Shock Mounting



**NI2111**  
Lower Control Arm Bush



LEFT

RIGHT

**NISSAN**

**ALMERA**

**FRONT**

**ALL MODELS**

*Year*

**2013-**

**DT1010**  
Outer Tie Rod End  
(Ø11.7\*Ø14.6/M12\*1.25)



**DT1310**  
Outer Tie Rod End Set  
(Ø11.7\*Ø14.6/M12\*1.25)

**DT1410**  
Rack End  
(14\*1.5/12\*1.25/227)



**DT1011**  
Outer Tie Rod End  
(Ø11.7\*Ø14.6/M12\*1.25)



**NI1514**  
Link Stabilizer  
L=255



**DT2110**  
Lower Control Arm Bush



**DT1910**  
Lower Ball Joint  
(Ø16)



**DT2010**  
Lower Control Arm

**DT2011**  
Lower Control Arm

**DT1910**  
Lower Ball Joint  
(Ø16)



**DT2111**  
Lower Control Arm Bush



**NI2813**  
Shock Mounting



**NI2813**  
Shock Mounting



**LEFT**

**RIGHT**

**NISSAN**

**INTERSTAR**

**FRONT**

**ALL MODELS**

*Year*

**2005-**

**NI1012**  
Outer Tie Rod End  
(Ø16.4\*Ø20.2/M16\*1.5)



**NI1322**  
Outer Tie Rod End Set  
(Ø16.4\*Ø20.2/M16\*1.5)

**NI1013**  
Outer Tie Rod End  
(Ø16.4\*Ø20.2/M16\*1.5)



**NI1413**  
Rack End  
(14\*1.5/16\*1.5/178)



**NI1515 / NI1516**  
Link Stabilizer  
L=127



**NI1610**  
Upper Ball Joint  
(Ø16.1)



**NI1610**  
Upper Ball Joint  
(Ø16.1)



**NI1915**  
Lower Ball Joint  
(Ø22)



**NI2112**  
Lower Control Arm Bush



**NI1915**  
Lower Ball Joint  
(Ø22)



**NI2018**  
Lower Control Arm

**NI2019**  
Lower Control Arm

**NI2113**  
Lower Control Arm Bush

**NI1916**  
Lower Ball Joint  
(Ø24)



**NI2112**  
Lower Control Arm Bush



**NI1916**  
Lower Ball Joint  
(Ø24)



**NI2020**  
Lower Control Arm

**NI2021**  
Lower Control Arm

**NI2113**  
Lower Control Arm Bush

**INTERSTAR**

**REAR**

**NI2910**  
Bush



**LEFT**

**RIGHT**

**NISSAN**

**JUKE**

**FRONT**

**ALL MODELS**

*Year*

**2010-**

**NI1014**  
Outer Tie Rod End  
(Ø11.9\*Ø14.7/M12\*1.25)



**NI1323**  
Outer Tie Rod End Set  
(Ø11.9\*Ø14.7/M12\*1.25)

**NI1015**  
Outer Tie Rod End  
(Ø11.9\*Ø14.7/M12\*1.25)



**NI1414**  
Rack End  
(16\*1.0/12\*1.25/217)



**NI1517**  
Link Stabilizer  
L=284



**NI2144**  
Lower Control Arm Bush



**NI1927**  
Lower Ball Joint  
(Ø18)



**NI1927**  
Lower Ball Joint  
(Ø18)



**NI2022**  
Lower Control Arm

**NI2023**  
Lower Control Arm

**NI2115**  
Lower Control Arm Bush



**NI2826**  
Shock Mounting



**NI2827**  
Shock Mounting



**LEFT**

**RIGHT**

**NISSAN**

**MAXIMA**

**FRONT**

**ALL MODELS**

*Year*

**1991-1996**

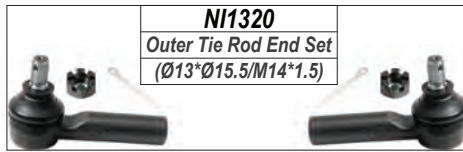

**NI1320**  
Outer Tie Rod End Set  
(Ø13\*Ø15.5/M14\*1.5)

**NI1028**  
Outer Tie Rod End  
(Ø13\*Ø15.5/M14\*1.5)



**NI1415**  
Rack End  
(16\*1.0/14\*1.5/308)



**NI1028**  
Outer Tie Rod End  
(Ø13\*Ø15.5/M14\*1.5)



**NI1416**  
Rack End  
(16\*1.0/14\*1.5/310)



**NI1427**  
Rack End  
(16\*1.0/14\*1.5/261)



**NI1518**  
Link Stabilizer  
L=84.5



**NI1928**  
Lower Ball Joint  
(Ø14.76)



**NI1928**  
Lower Ball Joint  
(Ø14.76)



**NI2024**  
Lower Control Arm



**NI2025**  
Lower Control Arm



**NI2116**  
Lower Control Arm Bush

**LEFT**

**RIGHT**



**NISSAN**

**MAXIMA**

**FRONT**

**A32**

*Year*

**1996-2000**

**NI1028**  
Outer Tie Rod End  
(Ø13\*Ø15.5/M14\*1.5)

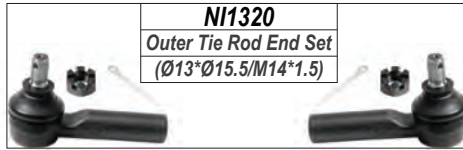

**NI1320**  
Outer Tie Rod End Set  
(Ø13\*Ø15.5/M14\*1.5)

**NI1415**  
Rack End  
(16\*1.0/14\*1.5/308)

**NI1028**  
Outer Tie Rod End  
(Ø13\*Ø15.5/M14\*1.5)



**NI1519**  
Link Stabilizer  
L=98



**NI1520 / NI1521**  
Link Stabilizer  
L=90



**NI1917**  
Lower Ball Joint  
(Ø11.6)



**NI2026**  
Lower Control Arm

**NI2027**  
Lower Control Arm

**NI1917**  
Lower Ball Joint  
(Ø11.6)



**LEFT**

**RIGHT**

**NISSAN**

**MAXIMA**

**FRONT**

**A33.QX**

*Year*

**2000-**

**NI1028**  
Outer Tie Rod End  
(Ø13\*Ø15.5/M14\*1.5)

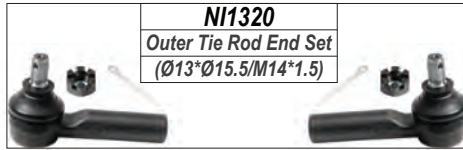

**NI1320**  
Outer Tie Rod End Set  
(Ø13\*Ø15.5/M14\*1.5)

**NI1415**  
Rack End  
(16\*1.0/14\*1.5/308)

**NI1028**  
Outer Tie Rod End  
(Ø13\*Ø15.5/M14\*1.5)



**NI1416**  
Rack End  
(16\*1.0/14\*1.5/310)



**NI1519**  
Link Stabilizer  
L=98



**NI1520 / NI1521**  
Link Stabilizer  
L=90



**NI1929**  
Lower Ball Joint  
(Ø15)



**NI2028**  
Lower Control Arm

**NI2029**  
Lower Control Arm

**NI1929**  
Lower Ball Joint  
(Ø15)



**LEFT**

**RIGHT**

**NISSAN**

**MICRA**

**FRONT**

**K12**

**Year**

**2004-2010**

**NI1016**  
Outer Tie Rod End  
(Ø11.8\*Ø15/M14\*1.5)



**NI1419**  
Rack End  
(14\*1.5/14\*1.5/308)



**NI1017**  
Outer Tie Rod End  
(Ø11.8\*Ø15/M14\*1.5)

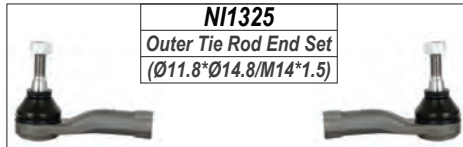

**NI1325**  
Outer Tie Rod End Set  
(Ø11.8\*Ø14.8/M14\*1.5)

**NI1018**  
Outer Tie Rod End  
(Ø11.8\*Ø14.8/M14\*1.5)



**NI1030**  
Outer Tie Rod End  
(Ø11.8\*Ø14.8/M14\*1.5)



**NI1522**  
Link Stabilizer  
L=248



**NI2117**  
Lower Control Arm Bush



**NI1918**  
Lower Ball Joint  
(Ø16)



**NI1918**  
Lower Ball Joint  
(Ø16)



**NI2030**  
Lower Control Arm



**NI2031**  
Lower Control Arm

**NI2118**  
Lower Control Arm Bush



**NI2814**  
Shock Mounting



**NI2911**  
Bush



**NI2815**  
Shock Mounting



**LEFT**

**RIGHT**

**NISSAN**

**MICRA**

**FRONT**

**K13**

**Year**

**2010-**

**DT1010**  
Outer Tie Rod End  
(Ø11.7\*Ø14.6/M12\*1.25)



**DT1310**  
Outer Tie Rod End Set  
(Ø11.7\*Ø14.6/M12\*1.25)

**DT1011**  
Outer Tie Rod End  
(Ø11.7\*Ø14.6/M12\*1.25)



**DT1410**  
Rack End  
(14\*1.5/12\*1.25/227)



**NI1514**  
Link Stabilizer  
L=255



**DT2110**  
Lower Control Arm Bush



**DT1910**  
Lower Ball Joint  
(Ø16)



**DT2010**  
Lower Control Arm

**DT2011**  
Lower Control Arm

**DT1910**  
Lower Ball Joint  
(Ø16)



**DT2111**  
Lower Control Arm Bush



**NI2816**  
Shock Mounting



**NI2816**  
Shock Mounting



**LEFT**

**RIGHT**

**NISSAN**

**MURANO**

**FRONT**

**Z50**

*Year*

**2005-2009**

**NI1031**  
Outer Tie Rod End  
(Ø14.8\*Ø18.6/M14\*1.5)

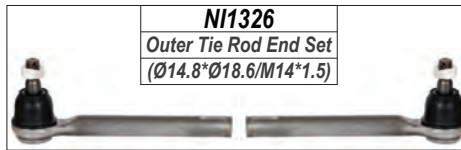

**NI1326**  
Outer Tie Rod End Set  
(Ø14.8\*Ø18.6/M14\*1.5)

**NI1420**  
Rack End  
(16\*1.0/14\*1.5/262)

**NI1031**  
Outer Tie Rod End  
(Ø14.8\*Ø18.6/M14\*1.5)



**NI1523 / NI1524**  
Link Stabilizer  
L=308



**NI1930**  
Lower Ball Joint  
(Ø20)



**NI2138**  
Lower Control Arm Bush



**NI2032**  
Lower Control Arm

**NI2033**  
Lower Control Arm

**NI1930**  
Lower Ball Joint  
(Ø20)



**NI2137**  
Lower Control Arm Bush

**NI2817**  
Shock Mounting



**NI2817**  
Shock Mounting



**MURANO**

**REAR**

**NI1525 / NI1526**  
Link Stabilizer  
L=85



**LEFT**

**RIGHT**



**NISSAN**

**MURANO**

**FRONT**

**Z51**

*Year*

**2009-**

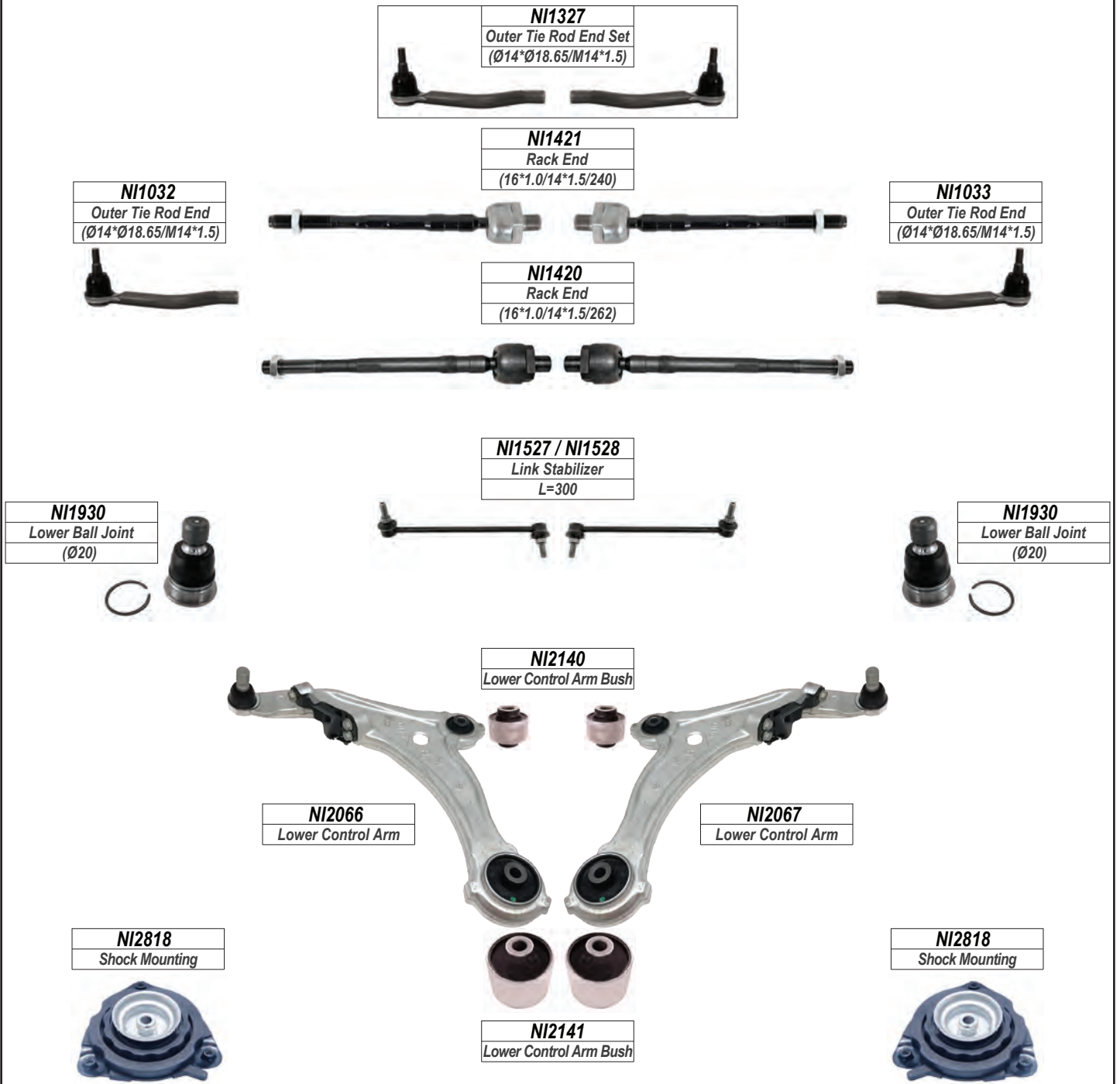

**MURANO**

**REAR**



**LEFT**

**RIGHT**

**NISSAN**

NAVARA  
PATHFINDER

FRONT

ALL MODELS

Year

2005-

**NI1034**  
Outer Tie Rod End  
(Ø14.8\*Ø18.63/M16\*1.5)



**NI1328**  
Outer Tie Rod End Set  
(Ø14.8\*Ø18.63/M16\*1.5)

**NI1422**  
Rack End  
(20\*1.0/16\*1.5/202)

**NI1035**  
Outer Tie Rod End  
(Ø14.8\*Ø18.63/M16\*1.5)



**NI1531 / NI1532**  
Link Stabilizer  
L=65



**NI1611**  
Upper Ball Joint  
(Ø14.75)



**NI1718**  
Upper Control Arm

**NI2139**  
Upper Control Arm Bush



**NI1719**  
Upper Control Arm

**NI1611**  
Upper Ball Joint  
(Ø14.75)



**NI1919**  
Lower Ball Joint  
(Ø22)



**NI2034**  
Lower Control Arm

**NI2035**  
Lower Control Arm

**NI2119**  
Lower Control Arm Bush

**NI1919**  
Lower Ball Joint  
(Ø22)



**NI2820**  
Shock Mounting



**NI2820**  
Shock Mounting



LEFT

RIGHT

**NISSAN**

**NAVARA**

**FRONT**

**ALL MODELS**

**Year**

**2016-**

**NI1019**  
Outer Tie Rod End  
(Ø14.7\*Ø18/M14\*1.5)



**NI1329**  
Outer Tie Rod End Set  
(Ø14.7\*Ø18/M14\*1.5)

**NI1417**  
Rack End  
(16\*1.5/14\*1.5/214)

**NI1020**  
Outer Tie Rod End  
(Ø14.7\*Ø18/M14\*1.5)



**NI1533**  
Link Stabilizer  
L=210



**NI1612**  
Upper Ball Joint  
(Ø14.8)



**NI1810**  
Upper Control Arm Bush

**NI1612**  
Upper Ball Joint  
(Ø14.8)



**NI1720**  
Upper Control Arm

**NI1721**  
Upper Control Arm

**NI1920**  
Lower Ball Joint  
(Ø24)



**NI2120**  
Lower Control Arm Bush

**NI1920**  
Lower Ball Joint  
(Ø24)



**NI2036**  
Lower Control Arm

**NI2037**  
Lower Control Arm

**LEFT**

**RIGHT**

**NISSAN**











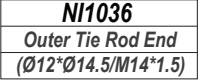





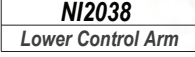

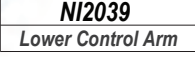

NP200

FRONT

ALL MODELS

Year

2008-

	<table border="1" style="margin: 0 auto;"> <tr><td style="text-align: center;"><b>NI1330</b></td></tr> <tr><td style="text-align: center;">Outer Tie Rod End Set (Ø12*Ø14.5/M14*1.5)</td></tr> </table> 	<b>NI1330</b>	Outer Tie Rod End Set (Ø12*Ø14.5/M14*1.5)					
<b>NI1330</b>								
Outer Tie Rod End Set (Ø12*Ø14.5/M14*1.5)								
<table border="1" style="margin: 0 auto;"> <tr><td style="text-align: center;"><b>NI1036</b></td></tr> <tr><td style="text-align: center;">Outer Tie Rod End (Ø12*Ø14.5/M14*1.5)</td></tr> </table> 	<b>NI1036</b>	Outer Tie Rod End (Ø12*Ø14.5/M14*1.5)	<table border="1" style="margin: 0 auto;"> <tr><td style="text-align: center;"><b>NI1423</b></td></tr> <tr><td style="text-align: center;">Rack End (12*1.0/14*1.5/194)</td></tr> </table> 	<b>NI1423</b>	Rack End (12*1.0/14*1.5/194)	<table border="1" style="margin: 0 auto;"> <tr><td style="text-align: center;"><b>NI1037</b></td></tr> <tr><td style="text-align: center;">Outer Tie Rod End (Ø12*Ø14.5/M14*1.5)</td></tr> </table> 	<b>NI1037</b>	Outer Tie Rod End (Ø12*Ø14.5/M14*1.5)
<b>NI1036</b>								
Outer Tie Rod End (Ø12*Ø14.5/M14*1.5)								
<b>NI1423</b>								
Rack End (12*1.0/14*1.5/194)								
<b>NI1037</b>								
Outer Tie Rod End (Ø12*Ø14.5/M14*1.5)								
<table border="1" style="margin: 0 auto;"> <tr><td style="text-align: center;"><b>MN1411</b></td></tr> <tr><td style="text-align: center;">Rack End (14*1.5/14*1.5/181)</td></tr> </table> 			<b>MN1411</b>	Rack End (14*1.5/14*1.5/181)				
<b>MN1411</b>								
Rack End (14*1.5/14*1.5/181)								
<table border="1" style="margin: 0 auto;"> <tr><td style="text-align: center;"><b>NI1931</b></td></tr> <tr><td style="text-align: center;">Lower Ball Joint (Ø18)</td></tr> </table> 	<b>NI1931</b>	Lower Ball Joint (Ø18)		<table border="1" style="margin: 0 auto;"> <tr><td style="text-align: center;"><b>NI1931</b></td></tr> <tr><td style="text-align: center;">Lower Ball Joint (Ø18)</td></tr> </table> 	<b>NI1931</b>	Lower Ball Joint (Ø18)		
<b>NI1931</b>								
Lower Ball Joint (Ø18)								
<b>NI1931</b>								
Lower Ball Joint (Ø18)								
<table border="1" style="margin: 0 auto;"> <tr><td style="text-align: center;"><b>NI2038</b></td></tr> <tr><td style="text-align: center;">Lower Control Arm</td></tr> </table> 	<b>NI2038</b>	Lower Control Arm		<table border="1" style="margin: 0 auto;"> <tr><td style="text-align: center;"><b>NI2039</b></td></tr> <tr><td style="text-align: center;">Lower Control Arm</td></tr> </table> 	<b>NI2039</b>	Lower Control Arm		
<b>NI2038</b>								
Lower Control Arm								
<b>NI2039</b>								
Lower Control Arm								
<table border="1" style="margin: 0 auto;"> <tr><td style="text-align: center;"><b>NI2121</b></td></tr> <tr><td style="text-align: center;">Lower Control Arm Bush</td></tr> </table> 			<b>NI2121</b>	Lower Control Arm Bush				
<b>NI2121</b>								
Lower Control Arm Bush								
<table border="1" style="margin: 0 auto;"> <tr><td style="text-align: center;"><b>NI1934</b></td></tr> <tr><td style="text-align: center;">Lower Ball Joint (Ø18)</td></tr> </table> 	<b>NI1934</b>	Lower Ball Joint (Ø18)		<table border="1" style="margin: 0 auto;"> <tr><td style="text-align: center;"><b>NI1934</b></td></tr> <tr><td style="text-align: center;">Lower Ball Joint (Ø18)</td></tr> </table> 	<b>NI1934</b>	Lower Ball Joint (Ø18)		
<b>NI1934</b>								
Lower Ball Joint (Ø18)								
<b>NI1934</b>								
Lower Ball Joint (Ø18)								
<table border="1" style="margin: 0 auto;"> <tr><td style="text-align: center;"><b>NI2068</b></td></tr> <tr><td style="text-align: center;">Lower Control Arm</td></tr> </table> 	<b>NI2068</b>	Lower Control Arm		<table border="1" style="margin: 0 auto;"> <tr><td style="text-align: center;"><b>NI2069</b></td></tr> <tr><td style="text-align: center;">Lower Control Arm</td></tr> </table> 	<b>NI2069</b>	Lower Control Arm		
<b>NI2068</b>								
Lower Control Arm								
<b>NI2069</b>								
Lower Control Arm								
<table border="1" style="margin: 0 auto;"> <tr><td style="text-align: center;"><b>NI2121</b></td></tr> <tr><td style="text-align: center;">Lower Control Arm Bush</td></tr> </table> 			<b>NI2121</b>	Lower Control Arm Bush				
<b>NI2121</b>								
Lower Control Arm Bush								
<table border="1" style="margin: 0 auto;"> <tr><td style="text-align: center;"><b>NI2821</b></td></tr> <tr><td style="text-align: center;">Shock Mounting</td></tr> </table> 	<b>NI2821</b>	Shock Mounting	<table border="1" style="margin: 0 auto;"> <tr><td style="text-align: center;"><b>RE2710</b></td></tr> <tr><td style="text-align: center;">Repair Kit</td></tr> </table> 	<b>RE2710</b>	Repair Kit	<table border="1" style="margin: 0 auto;"> <tr><td style="text-align: center;"><b>RE2710</b></td></tr> <tr><td style="text-align: center;">Repair Kit</td></tr> </table> 	<b>RE2710</b>	Repair Kit
<b>NI2821</b>								
Shock Mounting								
<b>RE2710</b>								
Repair Kit								
<b>RE2710</b>								
Repair Kit								
<table border="1" style="margin: 0 auto;"> <tr><td style="text-align: center;"><b>NI2821</b></td></tr> <tr><td style="text-align: center;">Shock Mounting</td></tr> </table> 	<b>NI2821</b>	Shock Mounting						
<b>NI2821</b>								
Shock Mounting								
<b>LEFT</b>		<b>RIGHT</b>						

**NISSAN**

**NV200**

**FRONT**

**ALL MODELS**

*Year*

**2013-**

**NI1331**  
Outer Tie Rod End Set  
(Ø11.85\*Ø14.7/M12\*1.25)

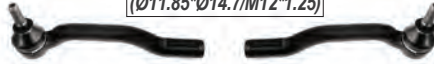

**NI1038**  
Outer Tie Rod End  
(Ø11.85\*Ø14.7/M12\*1.25)



**NI1424**  
Rack End  
(14\*1.5/12\*1.25/200)



**NI1039**  
Outer Tie Rod End  
(Ø11.85\*Ø14.7/M12\*1.25)



**NI1514**  
Link Stabilizer  
L=255



**NI2117**  
Lower Control Arm Bush



**NI1931**  
Lower Ball Joint  
(Ø18)



**NI1931**  
Lower Ball Joint  
(Ø18)



**NI2040**  
Lower Control Arm



**NI2041**  
Lower Control Arm



**NI2122**  
Lower Control Arm Bush



**NI2822**  
Shock Mounting



**NI2823**  
Shock Mounting



**LEFT**

**RIGHT**



**NISSAN**

NV350

FRONT

INPENDULO

Year

2014-

**NI1040**  
Outer Tie Rod End  
(Ø17.7\*Ø21.6/M20\*1.5)



**NI1332**  
Outer Tie Rod End Set  
(Ø17.7\*Ø21.6/M20\*1.5)

**NI1425**  
Rack End  
(24\*1.5/20\*1.5/275)



**NI1040**  
Outer Tie Rod End  
(Ø17.7\*Ø21.6/M20\*1.5)



**NI1531 / NI1532**  
Link Stabilizer  
L=65



**NI1722**  
Upper Control Arm

**NI1723**  
Upper Control Arm

**NI2135**  
Lower Control Arm Bush

**NI1932**  
Lower Ball Joint  
(Ø19.7)

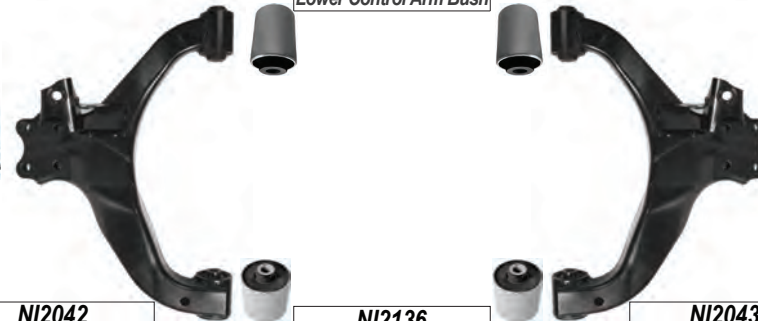

**NI2042**  
Lower Control Arm

**NI2136**  
Lower Control Arm Bush

**NI2043**  
Lower Control Arm

**NI1932**  
Lower Ball Joint  
(Ø19.7)



LEFT

RIGHT

**NISSAN**

**PATROL**

**FRONT**

**Y60**

*Year*

**1992-1998**

**NI1021**  
Outer Tie Rod End  
(Ø15.4\*Ø17.57/M30\*1.5)

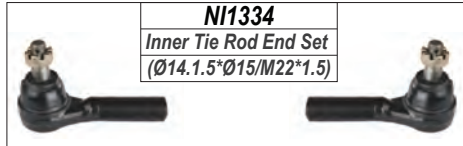
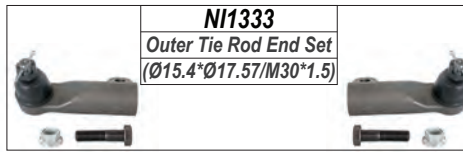

**NI1111**  
Inner Tie Rod End  
(Ø14.1.5\*Ø15/M22\*1.5)



**NI1022**  
Outer Tie Rod End  
(Ø15.4\*Ø17.57/M30\*1.5)



**PATROL**

**REAR**

**NI1534**  
Link Stabilizer  
L=130



**LEFT**

**RIGHT**

**NISSAN**

**PATROL**

**FRONT**

**Y61**

*Year*

**1998-2004**

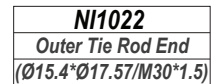
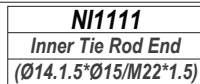
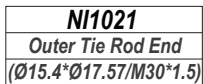
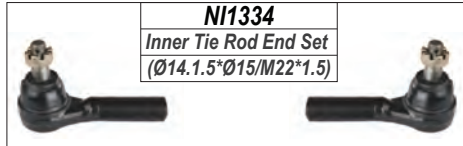
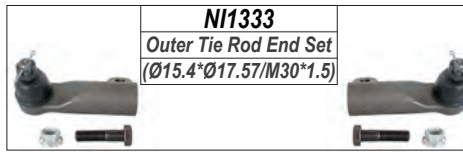

**PATROL**

**REAR**



**LEFT**

**RIGHT**

**NISSAN**

**PRIMASTER**

**FRONT**

**ALL MODELS**

*Year*

**2007-**

**NI1041**  
Outer Tie Rod End  
(Ø12\*Ø14.6/M14\*1.5)



**NI1335**  
Outer Tie Rod End Set  
(Ø12\*Ø14.6/M14\*1.5)

**NI1426**  
Rack End  
(12\*1.0/14\*1.5/263)



**NI1042**  
Outer Tie Rod End  
(Ø12\*Ø14.6/M14\*1.5)



**NI1536**  
Link Stabilizer  
L=279



**NI1921**  
Lower Ball Joint  
(Ø17.84)



**NI2123**  
Lower Control Arm Bush



**NI2044**  
Lower Control Arm

**NI2045**  
Lower Control Arm

**NI2122**  
Lower Control Arm Bush

**NI1921**  
Lower Ball Joint  
(Ø17.84)



**NI2824**  
Shock Mounting



**NI2824**  
Shock Mounting



**LEFT**

**RIGHT**

**NISSAN**

**PRIMERA**

**FRONT**

**P11**

*Year*

**1998-2002**

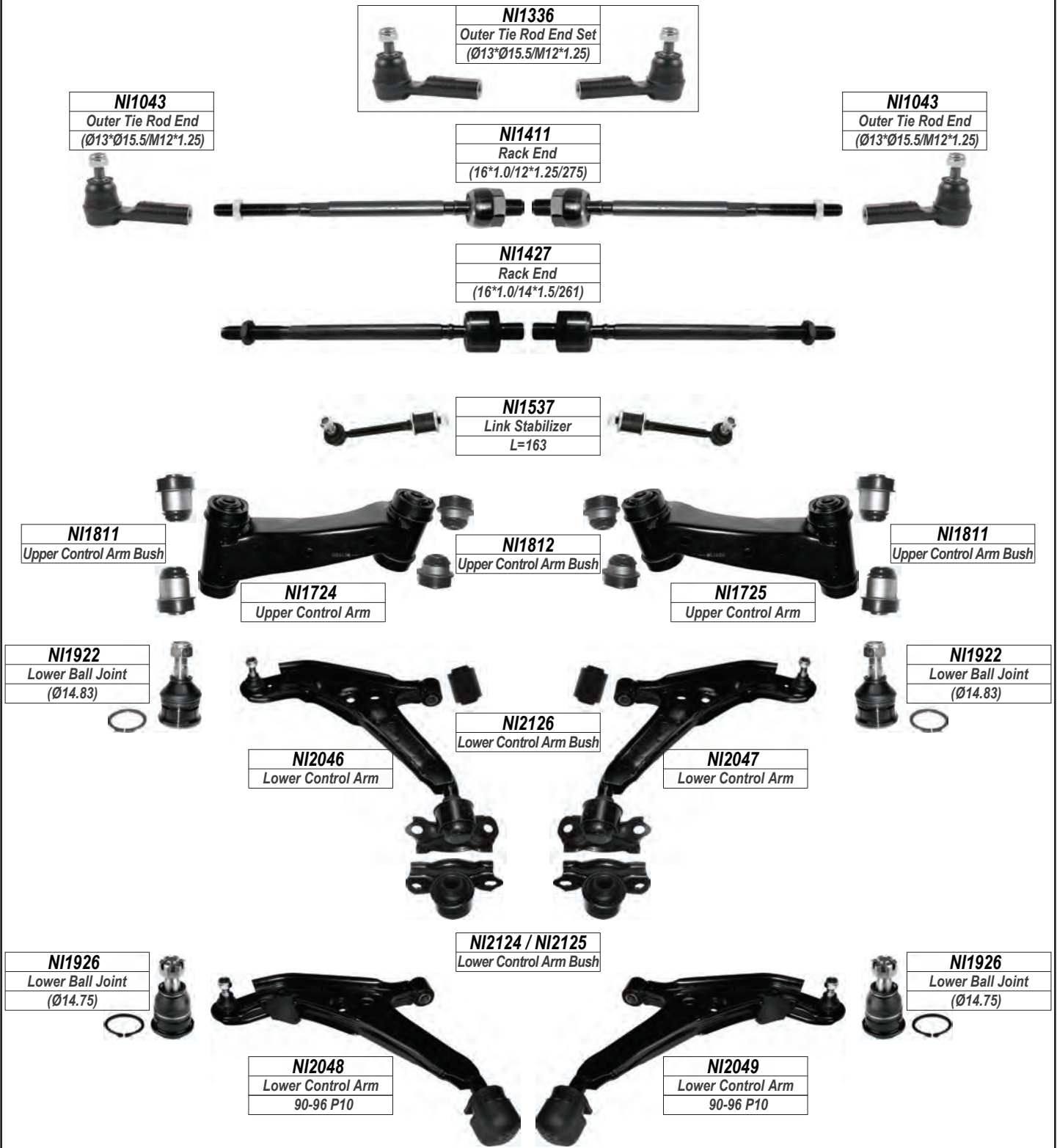

**PRIMERA**

**REAR**

**NI1538**

Link Stabilizer  
L=115

**LEFT**



**RIGHT**



**NISSAN**

**QASHQAI**

**FRONT**

**ALL MODELS**

*Year*

**2007-**

**NI1044**  
Outer Tie Rod End  
(Ø11.8\*Ø14.7/M14\*1.5)



**NI1337**  
Outer Tie Rod End Set  
(Ø11.8\*Ø14.7/M14\*1.5)

**NI1428**  
Rack End  
(22\*1.5/14\*1.5/233)

**NI1045**  
Outer Tie Rod End  
(Ø11.8\*Ø14.7/M14\*1.5)



**NI1527 / NI1528**  
Link Stabilizer  
L=300



**NI1930**  
Lower Ball Joint  
(Ø20)



**NI2127**  
Lower Control Arm Bush



**NI2050**  
Lower Control Arm

**NI2051**  
Lower Control Arm

**NI1930**  
Lower Ball Joint  
(Ø20)



**NI2822**  
Shock Mounting



**NI2114**  
Lower Control Arm Bush



**NI2823**  
Shock Mounting



**QASHQAI**

**REAR**

**NI1539 / NI1540**  
Link Stabilizer  
L=143.5



**LEFT**

**RIGHT**

**NISSAN**

**QASHQAI**

**FRONT**

**ALL MODELS**

*Year*

**2014-**

**NI1046**  
Outer Tie Rod End  
(Ø11.8\*Ø14.6/M14\*1.5)



**NI1338**  
Outer Tie Rod End Set  
(Ø11.8\*Ø14.6/M14\*1.5)

**NI1047**  
Outer Tie Rod End  
(Ø11.8\*Ø14.6/M14\*1.5)



**NI1517**  
Link Stabilizer  
L=284



**NI1930**  
Lower Ball Joint  
(Ø20)



**NI2128**  
Lower Control Arm Bush



**NI2052**  
Lower Control Arm

**NI2053**  
Lower Control Arm

**NI1930**  
Lower Ball Joint  
(Ø20)



**NI2129**  
Lower Control Arm Bush

**LEFT**

**RIGHT**

**NISSAN**

**SENTRA**

**FRONT**

**B12.N13**

*Year*

**1987-1992**

**NI1048**  
Outer Tie Rod End  
(Ø13\*Ø15.5/M12\*1.25)

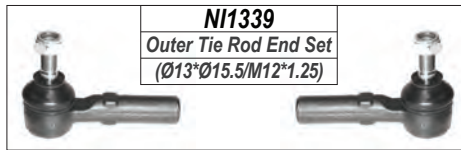

**NI1339**  
Outer Tie Rod End Set  
(Ø13\*Ø15.5/M12\*1.25)

**NI1429**  
Rack End  
(16\*1.0/12\*1.25/260)

**NI1048**  
Outer Tie Rod End  
(Ø13\*Ø15.5/M12\*1.25)

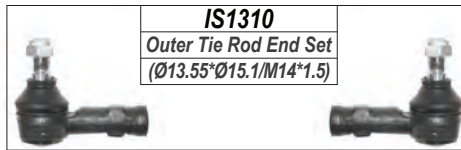

**IS1310**  
Outer Tie Rod End Set  
(Ø13.55\*Ø15.1/M14\*1.5)

**IS1011**  
Outer Tie Rod End  
(Ø13.55\*Ø15.1/M14\*1.5)



**NI1430**  
Rack End  
(14\*1.5/14\*1.5/286)



**IS1011**  
Outer Tie Rod End  
(Ø13.55\*Ø15.1/M14\*1.5)



**NI1518**  
Link Stabilizer  
L=84.5



**NI1926**  
Lower Ball Joint  
(Ø14.75)



**NI2130**  
Lower Control Arm Bush



**NI1926**  
Lower Ball Joint  
(Ø14.75)



**NI2054**  
Lower Control Arm

**NI2055**  
Lower Control Arm

**NI2131**  
Lower Control Arm Bush

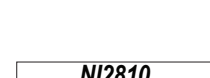

**NI2810**  
Stabilizer Bar Bush



**LEFT**

**RIGHT**

**NISSAN**

**SENTRA-SABRE**

**FRONT**

**B13.N15**

*Year*

**1992-1997**

**NI1048**  
Outer Tie Rod End  
(Ø13\*Ø15.5/M12\*1.25)

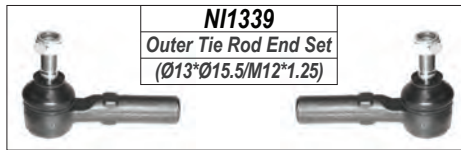

**NI1339**  
Outer Tie Rod End Set  
(Ø13\*Ø15.5/M12\*1.25)

**NI1411**  
Rack End  
(16\*1.0/12\*1.25/271)

**NI1048**  
Outer Tie Rod End  
(Ø13\*Ø15.5/M12\*1.25)



**NI1518**  
Link Stabilizer  
L=84.5



**NI1922**  
Lower Ball Joint  
(Ø14.83)



**NI2130**  
Lower Control Arm Bush



**NI2056**  
Lower Control Arm

**NI2057**  
Lower Control Arm

**NI1922**  
Lower Ball Joint  
(Ø14.83)



**NI2825**  
Shock Mounting



**NI2116**  
Lower Control Arm Bush

**NI2825**  
Shock Mounting



**SENTRA-SABRE**

**REAR**

**NI1541**  
Link Stabilizer  
L=175



**LEFT**

**RIGHT**

**NISSAN**

SENTRA-SABRE

FRONT

B14

Year

1997-2002

**NI1048**  
Outer Tie Rod End  
(Ø13\*Ø15.5/M12\*1.25)



**NI1429**  
Rack End  
(16\*1.0/12\*1.25/271)



**NI1048**  
Outer Tie Rod End  
(Ø13\*Ø15.5/M12\*1.25)

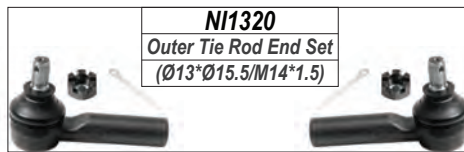

**NI1320**  
Outer Tie Rod End Set  
(Ø13\*Ø15.5/M14\*1.5)

**NI1028**  
Outer Tie Rod End  
(Ø13\*Ø15.5/M14\*1.5)



**NI1412**  
Rack End  
(16\*1.0/14\*1.5/286)



**NI1028**  
Outer Tie Rod End  
(Ø13\*Ø15.5/M14\*1.5)



**NI1518**  
Link Stabilizer  
L=84.5



**NI1922**  
Lower Ball Joint  
(Ø14.83)



**NI2130**  
Lower Control Arm Bush



**NI1922**  
Lower Ball Joint  
(Ø14.83)



**NI2056**  
Lower Control Arm

**NI2057**  
Lower Control Arm

**NI2825**  
Shock Mounting



**NI2825**  
Shock Mounting



**NI2116**  
Lower Control Arm Bush



SENTRA-SABRE

REAR

**NI1541**  
Link Stabilizer  
L=175



LEFT

RIGHT



**NISSAN**

**SENTRA**

**FRONT**

**ALL MODELS**

*Year*

**2013-**

**NI1014**  
Outer Tie Rod End  
(Ø11.9\*Ø14.7/M12\*1.25)



**NI1323**  
Outer Tie Rod End Set  
(Ø11.9\*Ø14.7/M12\*1.25)

**NI1015**  
Outer Tie Rod End  
(Ø11.9\*Ø14.7/M12\*1.25)



**NI1431**  
Rack End  
(16\*1.0/12\*1.25/217)



**NI1542**  
Link Stabilizer  
L=285



**NI2142**  
Lower Control Arm Bush



**NI1933**  
Lower Ball Joint  
(Ø18)



**NI2058**  
Lower Control Arm

**NI2059**  
Lower Control Arm

**NI1933**  
Lower Ball Joint  
(Ø18)



**NI2143**  
Lower Control Arm Bush



**NI2826**  
Shock Mounting



**NI2827**  
Shock Mounting



**LEFT**

**RIGHT**

**NISSAN**

**SKYLINE**

**FRONT**

**31**

*Year*

**1987-**

**NI1023**  
Outer Tie Rod End  
(Ø13.5\*Ø15/M14\*1.5)



**NI1340**  
Outer Tie Rod End Set  
(Ø13.5\*Ø15/M14\*1.5)

**NI1418**  
Rack End  
(14\*1.5/14\*1.5/138)



**NI1023**  
Outer Tie Rod End  
(Ø13.5\*Ø15/M14\*1.5)



**NI2060**  
Lower Control Arm



**NI2061**  
Lower Control Arm

**LEFT**

**RIGHT**

**NISSAN**

**TERRANO**

**FRONT**

**R20**

*Year*

**2000-**

**NI2215**

Center Rod

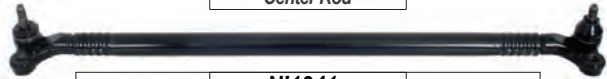

**NI1341**

Outer Tie Rod End Set  
(Ø14.4\*Ø16.4/M16\*1.5)

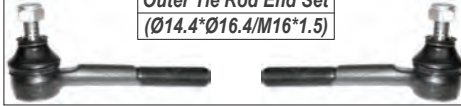

**NI1342**

Inner Tie Rod End Set  
(Ø14.4\*Ø16.4/M16\*1.5)



**NI1049**

Outer Tie Rod End  
(Ø14.4\*Ø16.4/M16\*1.5)



**NI1113**

Inner Tie Rod End  
(Ø14.4\*Ø16.4/M16\*1.5)



**NI1049**

Outer Tie Rod End  
(Ø14.4\*Ø16.4/M16\*1.5)



**NI1543**

Link Stabilizer  
L=89



**NI1613**

Upper Ball Joint  
(Ø16)



**NI2145**

Lower Control Arm Bush



**NI1613**

Upper Ball Joint  
(Ø16)



**NI1712**

Upper Control Arm



**NI1713**

Upper Control Arm



**NI1913**

Lower Ball Joint  
(Ø19.6)



**NI1913**

Lower Ball Joint  
(Ø19.6)



**NI2012**

Lower Control Arm



**NI2013**

Lower Control Arm



**LEFT**

**RIGHT**

**NISSAN**

TIIDA / LIVINA  
GRAND LIVINA

FRONT

ALL MODELS

Year

2006-

**NI1038**  
Outer Tie Rod End  
(Ø11.85\*Ø14.7/M12\*1.25)



**NI1424**  
Rack End  
(14\*1.5/12\*1.25/200)



**NI1039**  
Outer Tie Rod End  
(Ø11.85\*Ø14.7/M12\*1.25)



**NI1522**  
Link Stabilizer  
L=250



**NI2117**  
Lower Control Arm Bush



**NI1931**  
Lower Ball Joint  
(Ø18)



**NI1931**  
Lower Ball Joint  
(Ø18)



**NI2040**  
Lower Control Arm



**NI2041**  
Lower Control Arm

**NI2118**  
Lower Control Arm Bush



**NI2814**  
Shock Mounting



**NI2815**  
Shock Mounting



LEFT

RIGHT

**NISSAN**

**X-TRAIL**

**FRONT**

**T30**

*Year*

**2001-2008**

**NI1050**  
Outer Tie Rod End  
(Ø14.8\*Ø18.8/M14\*1.5)

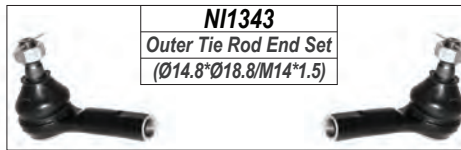

**NI1343**  
Outer Tie Rod End Set  
(Ø14.8\*Ø18.8/M14\*1.5)

**NI1050**  
Outer Tie Rod End  
(Ø14.8\*Ø18.8/M14\*1.5)



**NI1412**  
Rack End  
(16\*1.0/14\*1.5/286)



**NI1544 / NI1545**  
Link Stabilizer  
L=65



**NI2132**  
Lower Control Arm Bush



**NI2062**  
Lower Control Arm

**NI2063**  
Lower Control Arm

**NI2817**  
Shock Mounting



**NI2817**  
Shock Mounting



**NI2133**  
Lower Control Arm Bush



**X-TRAIL**

**REAR**

**NI1546**  
Link Stabilizer  
L=115



**LEFT**

**RIGHT**



**NISSAN**

**X-TRAIL**

**FRONT**

**T31**

*Year*

**2007-2014**

**NI1044**  
Outer Tie Rod End  
(Ø11.8\*Ø14.7/M14\*1.5)



**NI1337**  
Outer Tie Rod End Set  
(Ø11.8\*Ø14.7/M14\*1.5)

**NI1428**  
Rack End  
(22\*1.5/14\*1.5/233)

**NI1045**  
Outer Tie Rod End  
(Ø11.8\*Ø14.7/M14\*1.5)



**NI1544 / NI1545**  
Link Stabilizer  
L=65



**NI1527 / NI1528**  
Link Stabilizer  
L=300



**NI1930**  
Lower Ball Joint  
(Ø20)



**NI2127**  
Lower Control Arm Bush



**NI1930**  
Lower Ball Joint  
(Ø20)



**NI2050**  
Lower Control Arm

**NI2051**  
Lower Control Arm

**NI2822**  
Shock Mounting



**NI2114**  
Lower Control Arm Bush



**NI2823**  
Shock Mounting



**X-TRAIL**

**REAR**

**NI2912**  
Bush

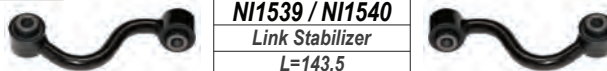

**NI1539 / NI1540**  
Link Stabilizer  
L=143.5

**NI2912**  
Bush



**NI2610**  
Lateral Link

**NI2912**  
Bush

**NI2611**  
Lateral Link

**NI2912**  
Bush

**NI2912**  
Bush



**NI2612**  
Lateral Link

**NI2912**  
Bush

**NI2613**  
Lateral Link

LEFT RIGHT

**NISSAN**

**X-TRAIL**

**FRONT**

**T32**

*Year*

**2014-**

**NI1051**  
Outer Tie Rod End  
(Ø11.8\*Ø14.6/M14\*1.5)



**NI1344**  
Outer Tie Rod End Set  
(Ø11.8\*Ø14.6/M14\*1.5)

**NI1432**  
Rack End  
(16\*1.5/14\*1.5/224)



**NI1052**  
Outer Tie Rod End  
(Ø11.8\*Ø14.6/M14\*1.5)



**NI2064**  
Lower Control Arm

**NI2065**  
Lower Control Arm

**LEFT**

**RIGHT**

**OPEL**

**ADAM**

**FRONT**

**ALL MODEL**

**Year**

**2014-**

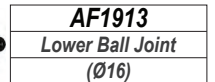
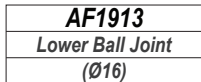
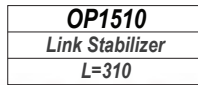
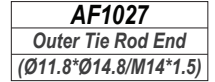
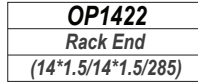
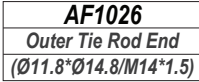
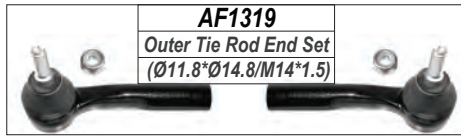

**LEFT**

**RIGHT**

**OPEL**

**ASCONA**

**FRONT**

**ALL**

*Year*

**1981-1988**

**DA1010**  
Outer Tie Rod End  
(Ø13\*Ø15.3/M16\*1.5)

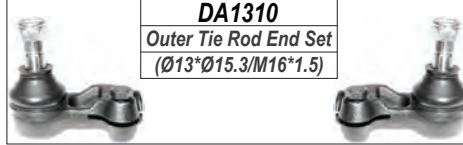

**DA1310**  
Outer Tie Rod End Set  
(Ø13\*Ø15.3/M16\*1.5)

**DA2210**  
Rack End  
(16\*1.5/16\*1.5/95)



**DA1011**  
Outer Tie Rod End  
(Ø13\*Ø15.3/M16\*1.5)



**DA2211 / DA2212**  
Rack End



**DA1510**  
Link Stabilizer  
L=197.5



**OP1914**  
Lower Ball Joint  
(Ø13.3)



**OP2012**  
Lower Control Arm



**OP2013**  
Lower Control Arm



**OP1914**  
Lower Ball Joint  
(Ø13.3)

**ASCONA**

**REAR**

**OP2910**  
Bush



**LEFT**

**RIGHT**

**OPEL**

**ASTRA/  
KADETT/CALIBRA**

**FRONT**

*Year*

**1991-1999**

**F**

**OP1016**  
Outer Tie Rod End  
(Ø13\*Ø15.5/M16\*2)

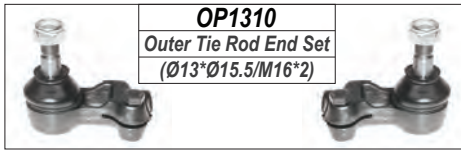

**OP1310**  
Outer Tie Rod End Set  
(Ø13\*Ø15.5/M16\*2)

**OP1017**  
Outer Tie Rod End  
(Ø13\*Ø15.5/M16\*2)



**OP1423**  
Rack End  
(16\*2.0/16\*2.0/100)



**OP1424 / OP1425**  
Rack End



**OP1511**  
Link Stabilizer  
L=79.5 (22mm)

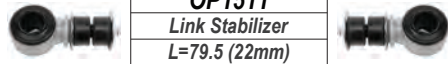

**OP1512**  
Link Stabilizer  
L=79.5 (18mm)



**OP1513**  
Link Stabilizer  
L=85

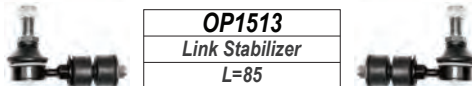

**OP2111**  
Lower Control Arm Bush

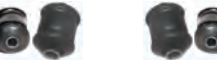

**OP1914**  
Lower Ball Joint  
(Ø13.3)



**OP1914**  
Lower Ball Joint  
(Ø13.3)



**OP2014**  
Lower Control Arm



**OP2015**  
Lower Control Arm

**OP2112**  
Lower Control Arm Bush

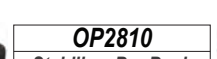

**OP2818**  
Shock Mounting



**OP2810**  
Stabilizer Bar Bush  
ID:18

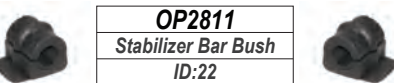

**OP2818**  
Shock Mounting



**OP2811**  
Stabilizer Bar Bush  
ID:22

**DA2910**  
Bush



**ASTRA/  
KADETT/CALIBRA**

**REAR**

**LEFT**

**RIGHT**



**OPEL**

**ASTRA**

**FRONT**

*Year*

**1999-2004**

**G**

**OP1018**  
Outer Tie Rod End  
(Ø13.3\*Ø17.2/M14\*1.5)



**OP1311**  
Outer Tie Rod End Set  
(Ø13.3\*Ø17.2/M14\*1.5)



**OP1018**  
Outer Tie Rod End  
(Ø13.3\*Ø17.2/M14\*1.5)



**OP1426**  
Rack End  
(18\*1.5/14\*1.5/280)



**OP1514**  
Link Stabilizer  
L=300



**OP1515**  
Link Stabilizer  
L=300 Plastic



**OP2114**  
Lower Control Arm Bush



**OP1915**  
Lower Ball Joint  
(Ø18)



**OP1915**  
Lower Ball Joint  
(Ø18)



**OP2016**  
Lower Control Arm

**OP2017**  
Lower Control Arm

**OP2822**  
Shock Mounting



**OP2822**  
Shock Mounting



**OP2819**  
Shock Mounting



**OP2113**  
Lower Control Arm Bush

**OP2812**  
Stabilizer Bar Bush  
ID:18



**OP2819**  
Shock Mounting



**ASTRA**

**REAR**

**DA2911**  
Bush



**LEFT**

**RIGHT**

**OPEL**

**ASTRA**

**FRONT**

**H**

*Year*

**2004-2009**

**OP1019**  
Outer Tie Rod End  
(Ø13.4\*Ø17/M14\*1.5)

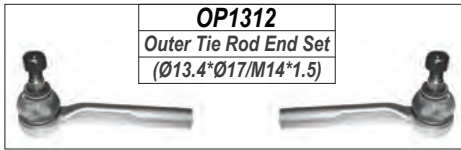

**OP1312**  
Outer Tie Rod End Set  
(Ø13.4\*Ø17/M14\*1.5)

**OP1020**  
Outer Tie Rod End  
(Ø13.4\*Ø17/M14\*1.5)



**OP1410**  
Rack End  
(18\*1.5/14\*1.5/283)



**OP1411**  
Rack End  
(16\*1.5/14\*1.5/277)



**OP1427**  
Rack End  
(18\*1.5/14\*1.5/278)



**OP1428**  
Rack End  
(16\*1.5/14\*1.5/274)



**OP1516**  
Link Stabilizer  
L=300



**OP1515**  
Link Stabilizer  
L=300 Plastic



**OP2114**  
Lower Control Arm Bush

**OP1915**  
Lower Ball Joint  
(Ø18)



**OP2016**  
Lower Control Arm

**OP2017**  
Lower Control Arm

**OP1915**  
Lower Ball Joint  
(Ø18)



**OP2820**  
Shock Mounting



**OP2115**  
Lower Control Arm Bush



**OP2810**  
Stabilizer Bar Bush  
ID:18



**OP2811**  
Stabilizer Bar Bush  
ID:22



**OP2820**  
Shock Mounting



**LEFT**

**RIGHT**

**OPEL**

**ASTRA**

**FRONT**

**J**

Year

**2010-2016**

**OP1010**  
Outer Tie Rod End  
(Ø13.2\*Ø18.1/M16\*1.5)



**OP1313**  
Outer Tie Rod End Set  
(Ø13.2\*Ø18.1/M16\*1.5)

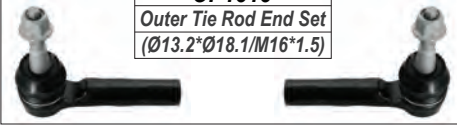

**OP1010**  
Outer Tie Rod End  
(Ø13.2\*Ø18.1/M16\*1.5)



**OP1412**  
Rack End  
(16\*1.5/16\*1.5/299)



**OP1413**  
Rack End  
(16\*1.5/16\*1.5/290)



**CH1414**  
Rack End  
(16\*1.5 /16\*1.5/284)



**CH1516**  
Link Stabilizer  
L=304



**OP1517**  
Link Stabilizer  
L=304

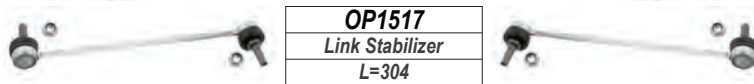

**CH2116**  
Lower Control Arm Bush



**CH2018**  
Lower Control Arm

**CH2019**  
Lower Control Arm

**OP2814**  
Stabilizer Bar Bush



**OP2814**  
Stabilizer Bar Bush



**CH2117**  
Lower Control Arm Bush

**CH2116**  
Lower Control Arm Bush



**CH2812**  
Shock Mounting



**CH2016**  
Lower Control Arm  
Aluminium

**CH2017**  
Lower Control Arm  
Aluminium

**CH2812**  
Shock Mounting



**CH2117**  
Lower Control Arm Bush

**LEFT**

**RIGHT**

**OPEL**

**ASTRA**

**FRONT**

**K**

*Year*

**2016-**

**OP1021**  
Outer Tie Rod End  
(Ø13.5\*Ø18/M14\*1.5)

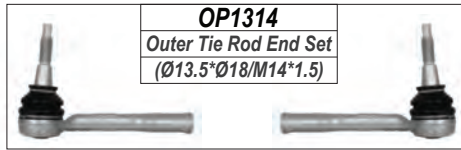

**OP1314**  
Outer Tie Rod End Set  
(Ø13.5\*Ø18/M14\*1.5)

**OP1022**  
Outer Tie Rod End  
(Ø13.5\*Ø18/M14\*1.5)



**OP1429**  
Rack End  
(14\*1.5/14\*1.5/262.5)



**OP1518 / OP1519**  
Link Stabilizer  
L=306



**OP2116**  
Lower Control Arm Bush



**OP1916**  
Lower Ball Joint  
(Ø12.5)



**OP1916**  
Lower Ball Joint  
(Ø12.5)



**OP2018**  
Lower Control Arm



**OP2019**  
Lower Control Arm



**OP2117**  
Lower Control Arm Bush



**LEFT**

**RIGHT**



**OPEL**

**CORSA (LITE)**

**FRONT**

Year

1996-2009

**B**

**OP1011**  
Outer Tie Rod End  
(Ø10.6\*Ø14/M12\*1.5)

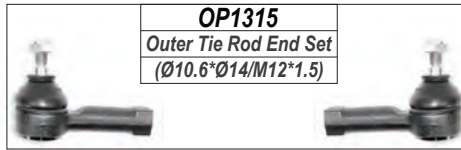

**OP1315**  
Outer Tie Rod End Set  
(Ø10.6\*Ø14/M12\*1.5)

**OP1414**  
Rack End  
(14\*1.5/12\*1.5/302)

**OP1011**  
Outer Tie Rod End  
(Ø10.6\*Ø14/M12\*1.5)



**OP1012**  
Outer Tie Rod End  
(Ø10.6\*Ø13.6/M12\*1.25)

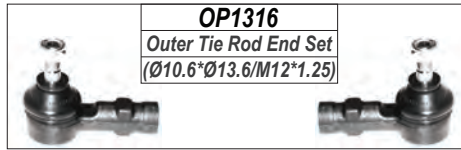

**OP1316**  
Outer Tie Rod End Set  
(Ø10.6\*Ø13.6/M12\*1.25)

**OP1415**  
Rack End  
(14\*1.5/12\*1.5/282)

**OP1012**  
Outer Tie Rod End  
(Ø10.6\*Ø13.6/M12\*1.25)



**OP1910**  
Lower Ball Joint  
(Ø15)



**CH2122**  
Lower Control Arm Bush



**OP200**  
Lower Control Arm

**OP201**  
Lower Control Arm

**OP1910**  
Lower Ball Joint  
(Ø15)



**OP1911**  
Lower Ball Joint  
(Ø15)



**CH2122**  
Lower Control Arm Bush



**OP202**  
Lower Control Arm

**OP203**  
Lower Control Arm

**OP1911**  
Lower Ball Joint  
(Ø15)



**OP2821**  
Shock Mounting



**OP2912**  
Bush



**OP2815**  
Stabilizer Bar Bush

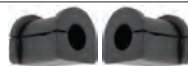

**OP2821**  
Shock Mounting



**CORSA (LITE)**

**REAR**

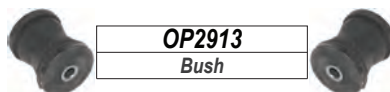

**OP2913**  
Bush

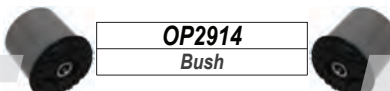

**OP2914**  
Bush

LEFT

RIGHT



**OPEL**

**CORSA (LDV)**

**FRONT**

*Year*

**1996-2004**

**B**

**OP1011**  
Outer Tie Rod End  
(Ø10.6\*Ø14/M12\*1.5)

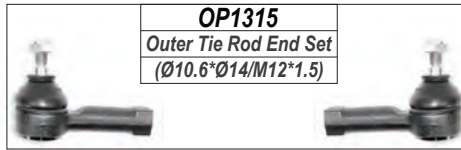

**OP1315**  
Outer Tie Rod End Set  
(Ø10.6\*Ø14/M12\*1.5)

**OP1011**  
Outer Tie Rod End  
(Ø10.6\*Ø14/M12\*1.5)



**OP1414**  
Rack End  
(14\*1.5/12\*1.5/302)

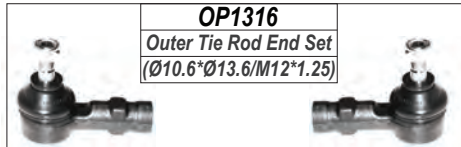

**OP1316**  
Outer Tie Rod End Set  
(Ø10.6\*Ø13.6/M12\*1.25)

**OP1012**  
Outer Tie Rod End  
(Ø10.6\*Ø13.6/M12\*1.25)



**OP1416**  
Rack End  
(14\*1.5/12\*1.5/314)

**OP1417**  
Rack End  
(14\*1.5/12\*1.5/309)

**OP1418**  
Rack End  
(14\*1.5/12\*1.5/286)

**OP1012**  
Outer Tie Rod End  
(Ø10.6\*Ø13.6/M12\*1.25)



**OP1910**  
Lower Ball Joint  
(Ø15)



**CH2122**  
Lower Control Arm Bush

**OP1910**  
Lower Ball Joint  
(Ø15)



**OP2020**  
Lower Control Arm

**OP2021**  
Lower Control Arm

**OP1911**  
Lower Ball Joint  
(Ø15)



**CH2122**  
Lower Control Arm Bush

**OP1911**  
Lower Ball Joint  
(Ø15)



**OP2022**  
Lower Control Arm

**OP2023**  
Lower Control Arm

**OP2821**  
Shock Mounting



**OP2815**  
Stabilizer Bar Bush

**OP2912**  
Bush

**OP2821**  
Shock Mounting



**CORSA (LDV)**

**REAR**

**OP2913**  
Bush

**OP2914**  
Bush

**LEFT**

**RIGHT**

**OPEL**

**CORSA / COMBO FRONT**  
**CORSA LDV UTILITY**

Year

2003-2010

C

**OP1011**  
Outer Tie Rod End  
(Ø10.6\*Ø14/M12\*1.5)

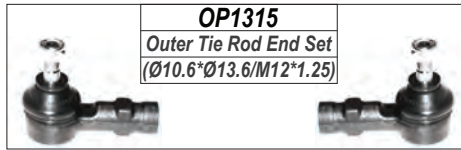

**OP1315**  
Outer Tie Rod End Set  
(Ø10.6\*Ø13.6/M12\*1.25)

**OP1414**  
Rack End  
(14\*1.5/12\*1.5/302)



**OP1011**  
Outer Tie Rod End  
(Ø10.6\*Ø14/M12\*1.5)



**OP1415**  
Rack End  
(14\*1.5/12\*1.5/282)



**OP1416**  
Rack End  
(14\*1.5/12\*1.5/314)



**OP1418**  
Rack End  
(14\*1.5/12\*1.5/286)



**OP2812**  
Stabilizer Bar Bush

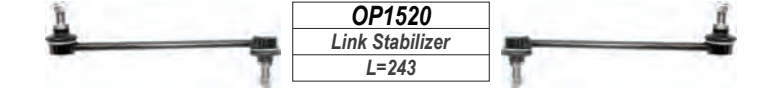

**OP1520**  
Link Stabilizer  
L=243

**OP2812**  
Stabilizer Bar Bush



**OP2816**  
Stabilizer Bar Bush



**OP2816**  
Stabilizer Bar Bush



**OP2118**  
Lower Control Arm Bush



**OP2024**  
Lower Control Arm

**OP2025**  
Lower Control Arm

**OP2119**  
Lower Control Arm Bush

**OP2914**  
Bush



**OP1912**  
Lower Ball Joint  
(Ø16)



**OP1912**  
Lower Ball Joint  
(Ø16)



**OP2822**  
Shock Mounting



**OP2822**  
Shock Mounting



**OP2819**  
Shock Mounting



**OP2819**  
Shock Mounting



**CORSA**

**REAR**

**LEFT**

**RIGHT**

**OPEL**

**CORSA**

**FRONT**

*Year*

**2008-2015**

**D**

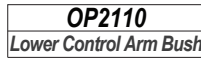
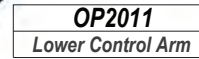
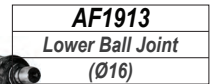
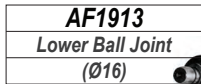
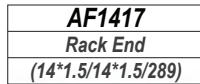
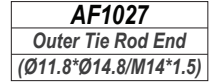
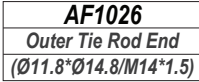
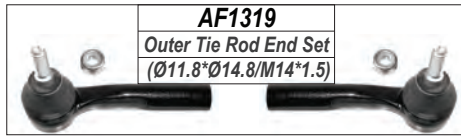

**CORSA**

**REAR**



**LEFT**

**RIGHT**

**OPEL**

**CORSA**

**FRONT**

**E**

**Year**

**2015-**

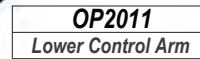
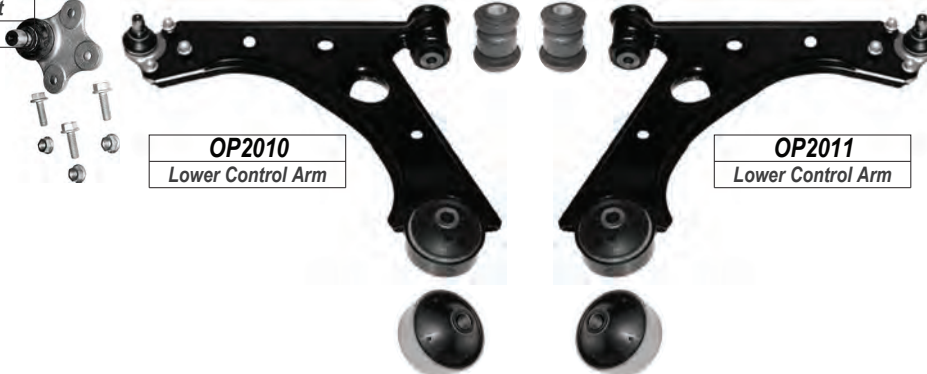
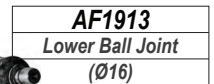
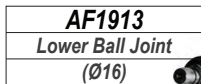
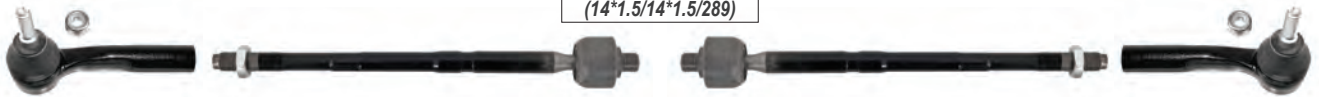
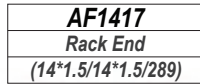
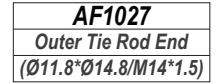
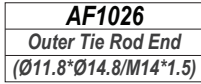
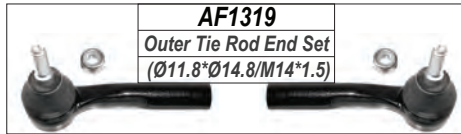

**LEFT**

**RIGHT**

**OPEL**

**FRONTERA**

**FRONT**

**ALL MODELS**

*Year*

**1991-1998**

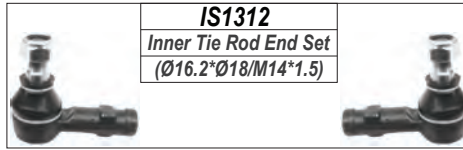

**IS1312**  
Inner Tie Rod End Set  
(Ø16.2\*Ø18/M14\*1.5)

**IS1012**  
Outer Tie Rod End  
(Ø16.2\*Ø18/M14\*1.5)



**IS1110**  
Inner Tie Rod End  
(Ø16.2\*Ø18/M14\*1.5)



**IS1110**  
Inner Tie Rod End  
(Ø16.2\*Ø18/M14\*1.5)



**IS1012**  
Outer Tie Rod End  
(Ø16.2\*Ø18/M14\*1.5)

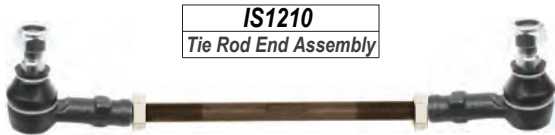

**IS1210**  
Tie Rod End Assembly

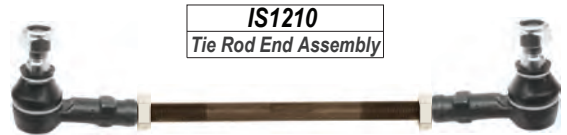

**IS1210**  
Tie Rod End Assembly

**OP1521 / OP1522**  
Link Stabilizer  
L=301



**IS1610**  
Upper Ball Joint  
(Ø17.6)



**IS1610**  
Upper Ball Joint  
(Ø17.6)



**FT1610**  
Upper Ball Joint  
(Ø17.56)



**FT1610**  
Upper Ball Joint  
(Ø17.56)



**FT1911**  
Lower Ball Joint  
(Ø20.6)



**FT1911**  
Lower Ball Joint  
(Ø20.6)



**LEFT**

**RIGHT**



**OPEL**

**KADETT.MONZA FRONT**

Year

1980-1993

**E**

**DA1010**  
Outer Tie Rod End  
(Ø13\*Ø15.3/M16\*1.5)

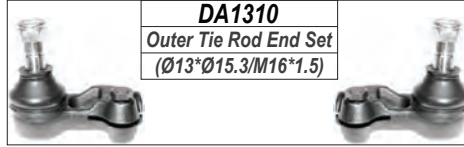

**DA1310**  
Outer Tie Rod End Set  
(Ø13\*Ø15.3/M16\*1.5)

**DA1011**  
Outer Tie Rod End  
(Ø13\*Ø15.3/M16\*1.5)



**DA2210**  
Rack End  
(16\*1.5/16\*1.5/95)



**DA2211 / DA2212**  
Rack End



**DA1510**  
Link Stabilizer  
L=197.5



**DA1914**  
Lower Ball Joint  
(Ø13.3)



**DA1914**  
Lower Ball Joint  
(Ø13.3)



**DA2111**  
Lower Control Arm Bush



**DA2010**  
Lower Control Arm

**DA2011**  
Lower Control Arm

**DA2110**  
Lower Control Arm Bush

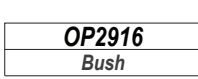

**DA2810**  
Shock Mounting



**OP2916**  
Bush



**DA2810**  
Shock Mounting



**KADETT.MONZA REAR**

**OP1523**  
Link Stabilizer  
L=50



**DA2910**  
Bush



**LEFT**

**RIGHT**

**OPEL**

**MERIVA**

**FRONT**

**A**

Year

**2003-2010**

**OP1013**  
Outer Tie Rod End  
(Ø10.7\*Ø13.2/M14\*1.5)

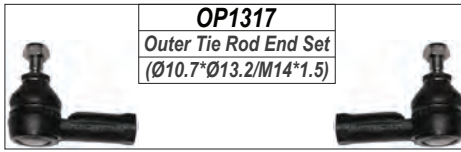

**OP1317**  
Outer Tie Rod End Set  
(Ø10.7\*Ø13.2/M14\*1.5)

**OP1419**  
Rack End  
(14\*1.5/14\*1.5/316)

**OP1013**  
Outer Tie Rod End  
(Ø10.7\*Ø13.2/M14\*1.5)

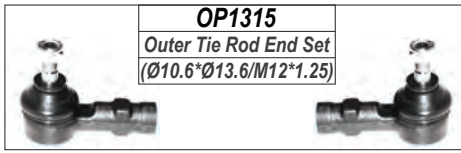

**OP1315**  
Outer Tie Rod End Set  
(Ø10.6\*Ø13.6/M12\*1.25)

**OP1011**  
Outer Tie Rod End  
(Ø10.6\*Ø14/M12\*1.5)



**OP1414**  
Rack End  
(14\*1.5/12\*1.5/302)

**OP1011**  
Outer Tie Rod End  
(Ø10.6\*Ø14/M12\*1.5)



**OP1520**  
Link Stabilizer  
L=243



**OP2118**  
Lower Control Arm Bush



**OP1917**  
Lower Ball Joint  
(Ø16)



**OP1918**  
Lower Ball Joint  
(Ø16)



**OP2822**  
Shock Mounting



**OP2026**  
Lower Control Arm



**OP2027**  
Lower Control Arm



**OP2822**  
Shock Mounting



**OP2119**  
Lower Control Arm Bush



**OP2819**  
Shock Mounting



**OP2812**  
Stabilizer Bar Bush

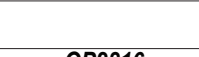

**OP2819**  
Shock Mounting



**OP2816**  
Stabilizer Bar Bush



**MERIVA**

**REAR**

**OP2911**  
Bush



**OP2917**  
Bush



**LEFT**

**RIGHT**

**OPEL**

**MERIVA**

**FRONT**

*Year*

**2012-**

**B**

**OP1023**  
Outer Tie Rod End  
(Ø13.3\*Ø17.3/M14\*1.5)

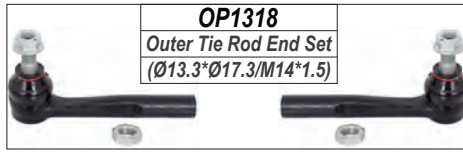

**OP1318**  
Outer Tie Rod End Set  
(Ø13.3\*Ø17.3/M14\*1.5)

**OP1420**  
Rack End  
(18\*1.5/14\*1.5/275)

**OP1024**  
Outer Tie Rod End  
(Ø13.3\*Ø17.3/M14\*1.5)



**OP1524**  
Link Stabilizer  
L=304



**OP2114**  
Lower Control Arm Bush

**OP1915**  
Lower Ball Joint  
(Ø18)



**OP2016**  
Lower Control Arm

**OP2017**  
Lower Control Arm

**OP1915**  
Lower Ball Joint  
(Ø18)



**OP2115**  
Lower Control Arm Bush

**LEFT**

**RIGHT**

**OPEL**

**MOKKA**

**FRONT**

**ALL MODELS**

*Year*

**2013-**

**OP1014**  
Outer Tie Rod End  
(Ø13\*Ø16.2/M14\*1.5)

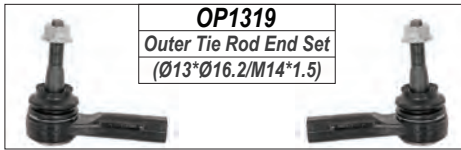

**OP1319**  
Outer Tie Rod End Set  
(Ø13\*Ø16.2/M14\*1.5)

**OP1421**  
Rack End  
(14\*1.5/14\*1.5/350)

**OP1014**  
Outer Tie Rod End  
(Ø13\*Ø16.2/M14\*1.5)



**OP1431**  
Rack End  
(14\*1.5/14\*1.5/350)



**OP1525 / OP1526**  
Link Stabilizer  
L=285



**CH1912**  
Lower Ball Joint  
(Ø18.17)

**OP2120**  
Lower Control Arm Bush



**CH1912**  
Lower Ball Joint  
(Ø18.17)

**OP2028**  
Lower Control Arm

**OP2029**  
Lower Control Arm



**CH2812**  
Shock Mounting



**OP2121**  
Lower Control Arm Bush



**CH2812**  
Shock Mounting



**LEFT**

**RIGHT**

**OPEL**

**MOVANO**

**FRONT**

**ALL MODELS**

*Year*

**1998-**

**NI1012**  
Outer Tie Rod End  
(Ø16.4\*Ø20.2/M16\*1.5)



**NI1322**  
Outer Tie Rod End Set  
(Ø16.4\*Ø20.2/M16\*1.5)

**NI1013**  
Outer Tie Rod End  
(Ø16.4\*Ø20.2/M16\*1.5)



**NI1413**  
Rack End  
(14\*1.5/16\*1.5/174)



**NI1515 / NI1516**  
Link Stabilizer  
L=127



**NI1610**  
Upper Ball Joint  
(Ø16.1)



**NI1610**  
Upper Ball Joint  
(Ø16.1)



**NI2112**  
Lower Control Arm Bush



**NI1915**  
Lower Ball Joint  
(Ø22)



**NI1915**  
Lower Ball Joint  
(Ø22)



**NI2018**  
Lower Control Arm

**NI2019**  
Lower Control Arm

**NI2113**  
Lower Control Arm Bush



**NI1916**  
Lower Ball Joint  
(Ø24)



**NI1916**  
Lower Ball Joint  
(Ø24)



**NI2020**  
Lower Control Arm

**NI2021**  
Lower Control Arm

**NI2113**  
Lower Control Arm Bush

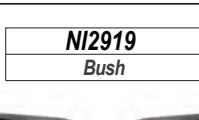

**MOVANO**

**REAR**

**NI2919**  
Bush



**LEFT**

**RIGHT**



**OPEL**

**RECORD. SENATOR FRONT**

**E**

Year

1982-1991

**OP2210**

Center Rod



**OP1320**

Outer Tie Rod End Set  
(Ø13.3\*Ø15.3/M14\*1.5)

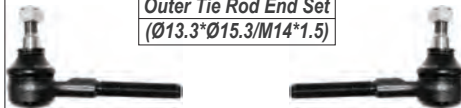

**OP1321**

Inner Tie Rod End Set  
(Ø13.3\*Ø15.3/M14\*1.5)

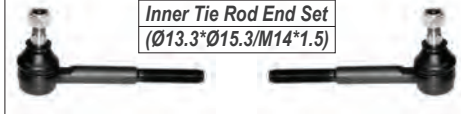

**OP1015**

Outer Tie Rod End  
(Ø13.3\*Ø15.3/M14\*1.5)



**OP1110**

Inner Tie Rod End  
(Ø13.3\*Ø15.3/M14\*1.5)



**OP1015**

Outer Tie Rod End  
(Ø13.3\*Ø15.3/M14\*1.5)



**OP1527**

Link Stabilizer  
L=195



**OP1913**

Lower Ball Joint  
(Ø14)



**OP1913**

Lower Ball Joint  
(Ø14)



**MOVANO**

**REAR**

**OP1523**

Link Stabilizer  
L=50



**OP2918**

Bush



**LEFT**

**RIGHT**

**OPEL**

**TIGRA**

**FRONT**

**ALL MODELS**

*Year*

**2005-**

**OP1012**  
Outer Tie Rod End  
(Ø10.6\*Ø13.6/M12\*1.25)

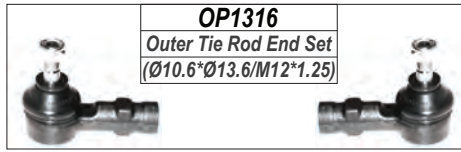

**OP1316**  
Outer Tie Rod End Set  
(Ø10.6\*Ø13.6/M12\*1.25)

**OP1430**  
Rack End  
(14\*1.5/12\*1.25/309)

**OP1012**  
Outer Tie Rod End  
(Ø10.6\*Ø13.6/M12\*1.25)



**OP2118**  
Lower Control Arm Bush

**OP1912**  
Lower Ball Joint  
(Ø16)

**OP2024**  
Lower Control Arm

**OP2025**  
Lower Control Arm

**OP2119**  
Lower Control Arm Bush



**OP1912**  
Lower Ball Joint  
(Ø16)

**LEFT**

**RIGHT**

**OPEL**

**VIVARO**

**FRONT**

**ALL MODELS**

*Year*

**2001-**

**NI1041**  
Outer Tie Rod End  
(Ø12\*Ø14.6/M14\*1.5)



**NI1335**  
Outer Tie Rod End Set  
(Ø12\*Ø14.6/M14\*1.5)

**NI1426**  
Rack End  
(12\*1.0/14\*1.5/263)



**NI1042**  
Outer Tie Rod End  
(Ø12\*Ø14.6/M14\*1.5)



**NI1536**  
Link Stabilizer  
L=279



**NI1921**  
Lower Ball Joint  
(Ø17.84)



**NI2123**  
Lower Control Arm Bush



**NI2044**  
Lower Control Arm

**NI2045**  
Lower Control Arm

**NI1921**  
Lower Ball Joint  
(Ø17.84)



**OP2122**  
Lower Control Arm Bush

**NI2123**  
Lower Control Arm Bush

**OP1919**  
Lower Ball Joint  
(Ø17.84)



**OP2030**  
Lower Control Arm

**OP2031**  
Lower Control Arm

**OP1919**  
Lower Ball Joint  
(Ø17.84)



**NI2824**  
Shock Mounting



**OP2122**  
Lower Control Arm Bush

**NI2824**  
Shock Mounting



**LEFT**

**RIGHT**

**OPEL**

**ZAFIRA**

**FRONT**

Year

2001-2006

**A**

**OP1311**

Outer Tie Rod End Set  
(Ø13.3\*Ø17.2/M14\*1.5)



**OP1018**

Outer Tie Rod End  
(Ø13.3\*Ø17.2/M14\*1.5)



**OP1018**

Outer Tie Rod End  
(Ø13.3\*Ø17.2/M14\*1.5)



**OP1426**

Rack End  
(18\*1.5/14\*1.5/280)



**OP1514**

Link Stabilizer  
L=300



**OP1515**

Link Stabilizer  
L=300 Plastic



**OP2114**

Lower Control Arm Bush



**OP1915**

Lower Ball Joint  
(Ø18)



**OP1915**

Lower Ball Joint  
(Ø18)



**OP2016**

Lower Control Arm



**OP2017**

Lower Control Arm

**OP2822**

Shock Mounting



**OP2822**

Shock Mounting



**OP2113**

Lower Control Arm Bush



**OP2819**

Shock Mounting



**OP2812**

Stabilizer Bar Bush  
ID:18



**OP2819**

Shock Mounting



**ZAFIRA**

**REAR**

**DA2911**

Bush



**LEFT**

**RIGHT**

**OPEL**

**ZAFIRA**

**FRONT**

*Year*

**2005-2012**

**B**

**OP1312**  
Outer Tie Rod End Set  
(Ø13.4\*Ø17/M14\*1.5)

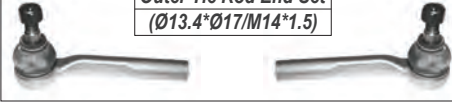

**OP1019**  
Outer Tie Rod End  
(Ø13.4\*Ø17/M14\*1.5)



**OP1020**  
Outer Tie Rod End  
(Ø13.4\*Ø17/M14\*1.5)



**OP1410**  
Rack End  
(18\*1.5/14\*1.5/283)



**OP1411**  
Rack End  
(16\*1.5/14\*1.5/277)



**OP1516**  
Link Stabilizer  
L=300



**OP1515**  
Link Stabilizer  
L=300 Plastic



**OP2114**  
Lower Control Arm Bush

**OP1915**  
Lower Ball Joint  
(Ø18)



**OP2016**  
Lower Control Arm

**OP2017**  
Lower Control Arm

**OP1915**  
Lower Ball Joint  
(Ø18)



**OP2115**  
Lower Control Arm Bush



**OP2820**  
Shock Mounting



**OP2820**  
Shock Mounting



**LEFT**

**RIGHT**



**PEUGEOT**

1007

FRONT

ALL MODELS

Year

2005-

**CI1015**  
Outer Tie Rod End  
(Ø12.1\*Ø15.1/M14\*1.5)



**CI1313**  
Outer Tie Rod End Set  
(Ø12.1\*Ø15.1/M14\*1.5)

**CI1413**  
Rack End  
(12\*1.0/14\*1.5/239)



**CI1016**  
Outer Tie Rod End  
(Ø12.1\*Ø15.1/M14\*1.5)



**CI1513**  
Link Stabilizer  
L=335



**CI2116**  
Lower Control Arm Bush



**CI1914**  
Lower Ball Joint  
(Ø18)



**CI2016**  
Lower Control Arm

**CI2017**  
Lower Control Arm

**CI1914**  
Lower Ball Joint  
(Ø18)



**CI2117**  
Lower Control Arm Bush



**CI2813**  
Shock Mounting(Pin Mid)



**CI2813**  
Shock Mounting(Pin Mid)



LEFT

RIGHT

**PEUGEOT**

107

FRONT

ALL MODELS

Year

2005-

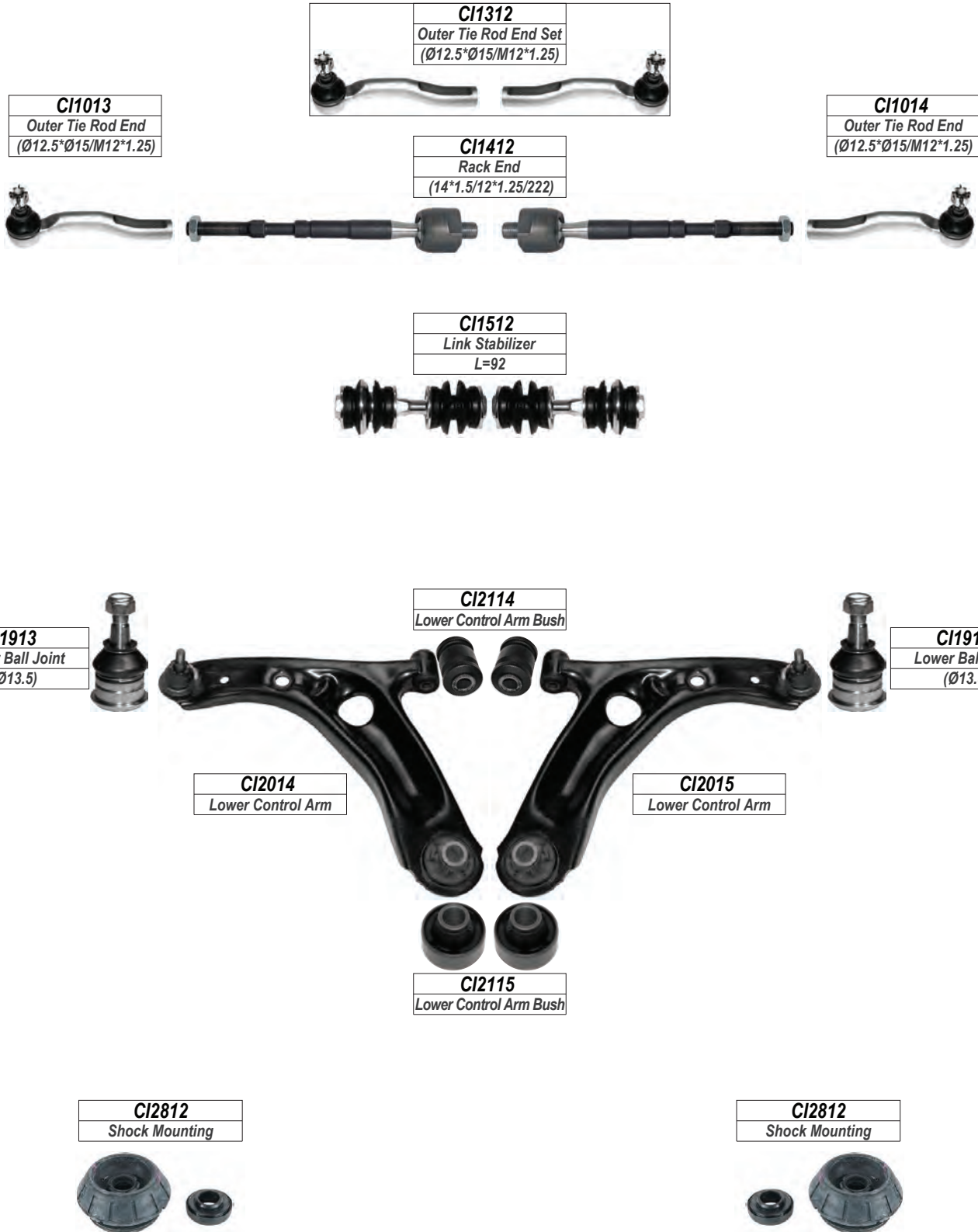

**LEFT**

**RIGHT**

**PEUGEOT**

2008

FRONT

ALL MODELS

Year

2012-

**PE1023**  
Outer Tie Rod End  
(Ø12.1\*Ø15/M14\*1.5)



**PE1310**  
Outer Tie Rod End Set  
(Ø12.1\*Ø15/M14\*1.5)

**PE1410**  
Rack End  
(12\*1.0/14\*1.5/225)



**PE1024**  
Outer Tie Rod End  
(Ø12.1\*Ø15/M14\*1.5)



**PE1510 / PE1511**  
Link Stabilizer  
L=330



**CI2118**  
Lower Control Arm Bush



**PE1910**  
Lower Ball Joint  
(Ø18)



**PE2010**  
Lower Control Arm

**PE2011**  
Lower Control Arm

**PE1910**  
Lower Ball Joint  
(Ø18)



**CI2119**  
Lower Control Arm Bush



LEFT

RIGHT

**PEUGEOT**

206

FRONT

ALL MODELS

Year

1998-2009

**CI1019**  
Outer Tie Rod End  
(Ø12.1\*Ø15.85/M14\*1.5)



**CI1315**  
Outer Tie Rod End Set  
(Ø12.1\*Ø15.85/M14\*1.5)

**PE1411**  
Rack End  
(14\*1.5/14\*1.5/297)

**CI1020**  
Outer Tie Rod End  
(Ø12.1\*Ø15.85/M14\*1.5)



**CI1513**  
Link Stabilizer  
L=335



**PE2110**  
Lower Control Arm Bush



**PE2012**  
Lower Control Arm



**PE2013**  
Lower Control Arm



**CI2113**  
Lower Control Arm Bush

**PE2112**  
Lower Control Arm Bush



**PE2014**  
Lower Control Arm  
GTI Only



**PE2015**  
Lower Control Arm  
GTI Only



**PE2810**  
Shock Mounting



**PE2811**  
Shock Mounting



**PE2110**  
Lower Control Arm Bush



LEFT

RIGHT

**PEUGEOT**

207

FRONT

ALL MODELS

Year

2006-2012

**PE1010**  
Outer Tie Rod End  
(Ø12.2\*Ø15.2/M16\*1.5)

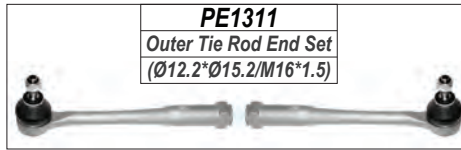

**PE1311**  
Outer Tie Rod End Set  
(Ø12.2\*Ø15.2/M16\*1.5)

**PE1412**  
Rack End  
(12\*1.0/16\*1.5/211)



**PE1011**  
Outer Tie Rod End  
(Ø12.2\*Ø15.2/M16\*1.5)



**PE1512 / PE1513**  
Link Stabilizer  
L=330



**PE2113**  
Lower Control Arm Bush



**PE1911**  
Lower Ball Joint  
(Ø18)



**PE1911**  
Lower Ball Joint  
(Ø18)



**PE2016**  
Lower Control Arm



**PE2017**  
Lower Control Arm



**PE2114**  
Lower Control Arm Bush



**CI2815**  
Shock Mounting



**CI2815**  
Shock Mounting



LEFT

RIGHT



**PEUGEOT**

208

FRONT

ALL MODELS

Year

2012-

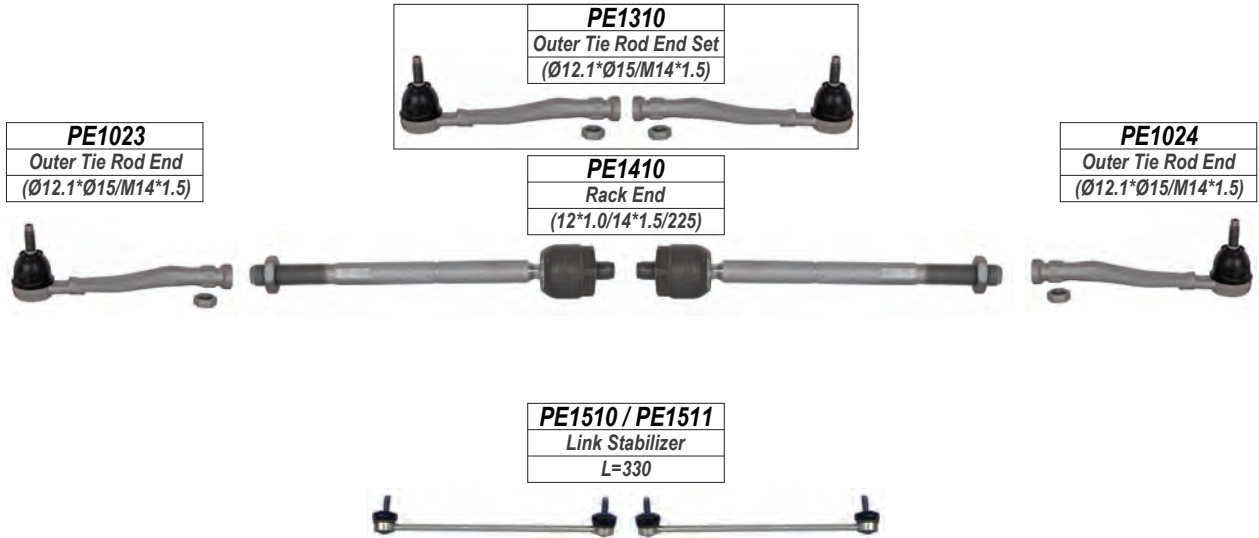

**CI2814**  
Shock Mounting



**CI2814**  
Shock Mounting



**LEFT**

**RIGHT**

**PEUGEOT**

3008

FRONT

ALL MODELS

Year

2009-

**CI1311**

Outer Tie Rod End Set  
(Ø12\*Ø15/M14\*1.5)



**CI1011**

Outer Tie Rod End  
(Ø12\*Ø15/M14\*1.5)



**PE1415**

Rack End  
(14\*1.5/14\*1.5/277)



**CI1011**

Outer Tie Rod End  
(Ø12\*Ø15/M14\*1.5)



**PE1514**

Link Stabilizer  
L=333



**CI2112**

Lower Control Arm Bush



**CI1912**

Lower Ball Joint  
(Ø15.7)



**CI2012**

Lower Control Arm



**CI2013**

Lower Control Arm

**CI1912**

Lower Ball Joint  
(Ø15.7)



**CI2113**

Lower Control Arm Bush



**CI2816**

Shock Mounting



**CI2816**

Shock Mounting



LEFT

RIGHT

**PEUGEOT**

**306**

**FRONT**

**ALL MODELS**

Year

**1993-2003**

**CI1010**  
Outer Tie Rod End  
(Ø12.1\*Ø15.85/M14\*1.5)

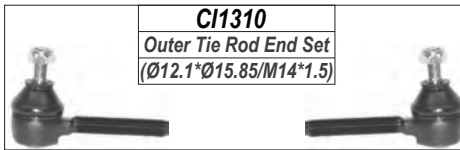

**CI1310**  
Outer Tie Rod End Set  
(Ø12.1\*Ø15.85/M14\*1.5)

**PE1413**  
Rack End  
(12\*1.0/14\*1.5/375)

**CI1010**  
Outer Tie Rod End  
(Ø12.1\*Ø15.85/M14\*1.5)

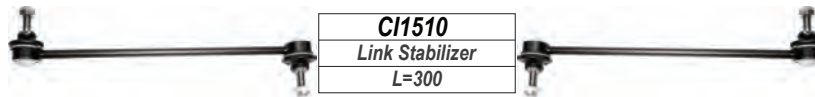

**CI1510**  
Link Stabilizer  
L=300

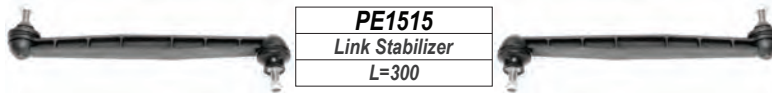

**PE1515**  
Link Stabilizer  
L=300

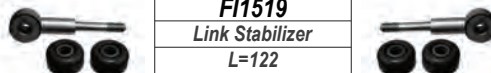

**FI1519**  
Link Stabilizer  
L=122

**CI2110**  
Lower Control Arm Bush

**PE1912**  
Lower Ball Joint  
(Ø16)



**PE2018**  
Lower Control Arm



**PE2019**  
Lower Control Arm



**PE1912**  
Lower Ball Joint  
(Ø16)

**CI2111**  
Lower Control Arm Bush

**CI2110**  
Lower Control Arm Bush

**PE1913**  
Lower Ball Joint  
(Ø18)



**PE2020**  
Lower Control Arm



**PE2021**  
Lower Control Arm



**PE1913**  
Lower Ball Joint  
(Ø18)

**PE2812**  
Shock Mounting



**PE2812**  
Shock Mounting



**CI2111**  
Lower Control Arm Bush

**CI2910**  
Bush



**306**

**REAR**

**LEFT**

**RIGHT**

**PEUGEOT**

307

FRONT

ALL MODELS

Year

2000-2008

**CI1019**  
Outer Tie Rod End  
(Ø12.1\*Ø15.85/M14\*1.5)



**CI1315**  
Outer Tie Rod End Set  
(Ø12.1\*Ø15.85/M14\*1.5)

**CI1020**  
Outer Tie Rod End  
(Ø12.1\*Ø15.85/M14\*1.5)

**CI1415**  
Rack End  
(14\*1.5/14\*1.5/319)



**PE1414**  
Rack End  
(14\*1.5/14\*1.5/342)



**CI1515**  
Link Stabilizer  
L=335



**CI2112**  
Lower Control Arm Bush

**CI1912**  
Lower Ball Joint  
(Ø15.7)



**CI2012**  
Lower Control Arm

**CI2013**  
Lower Control Arm

**CI1912**  
Lower Ball Joint  
(Ø15.7)



**CI2811**  
Shock Mounting



**CI2113**  
Lower Control Arm Bush



**CI2811**  
Shock Mounting



LEFT

RIGHT

**PEUGEOT**

308

FRONT

ALL MODELS

Year

2008-2013

**CI1311**

Outer Tie Rod End Set  
(Ø12\*Ø15/M14\*1.5)



**CI1011**

Outer Tie Rod End  
(Ø12\*Ø15/M14\*1.5)

**CI1011**

Outer Tie Rod End  
(Ø12\*Ø15/M14\*1.5)

**PE1415**

Rack End  
(14\*1.5/14\*1.5/277)

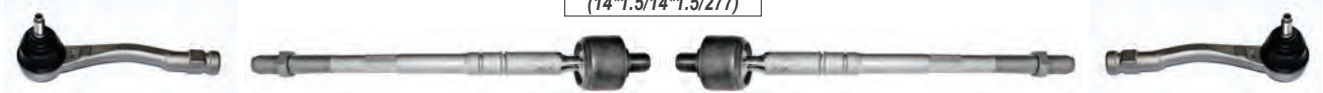

**PE1514**

Link Stabilizer  
L=333



**CI2112**

Lower Control Arm Bush

**CI1912**

Lower Ball Joint  
(Ø15.7)



**CI1912**

Lower Ball Joint  
(Ø15.7)



**CI2012**

Lower Control Arm



**CI2013**

Lower Control Arm

**CI2113**

Lower Control Arm Bush

**CI2816**

Shock Mounting



**CI2816**

Shock Mounting



LEFT

RIGHT



**PEUGEOT**

308

FRONT

ALL MODELS

Year

2013-

**CI1030**  
Outer Tie Rod End  
(Ø14.4\*Ø19/M14\*1.5)



**CI1318**  
Outer Tie Rod End Set  
(Ø14.4\*Ø19/M14\*1.5)

**CI1421**  
Rack End  
(14\*1.5/14\*1.5/220)



**CI1031**  
Outer Tie Rod End  
(Ø14.4\*Ø19/M14\*1.5)



**PE1516**  
Link Stabilizer  
L=333



**PE2116**  
Lower Control Arm Bush

**PE1914**  
Lower Ball Joint  
(Ø16.6)



**PE2022**  
Lower Control Arm

**PE2023**  
Lower Control Arm

**PE1914**  
Lower Ball Joint  
(Ø16.6)

**PE2115**  
Lower Control Arm Bush



**LEFT**

**RIGHT**

**PEUGEOT**

405

FRONT

ALL MODELS

Year

1992-1997

**PE1012**  
Outer Tie Rod End  
(Ø11.9/M14\*1.5)

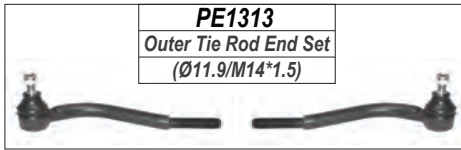

**PE1313**  
Outer Tie Rod End Set  
(Ø11.9/M14\*1.5)

**PE1416**  
Rack End  
(12\*1.0/14\*1.5/183)



**PE1013**  
Outer Tie Rod End  
(Ø11.9/M14\*1.5)



**PE1517**  
Link Stabilizer  
L=166



**C11916**  
Lower Ball Joint  
(Ø15.8)



**PE2118**  
Lower Control Arm Bush



**PE2024**  
Lower Control Arm

**PE2025**  
Lower Control Arm

**C11916**  
Lower Ball Joint  
(Ø15.8)



**PE2117**  
Lower Control Arm Bush



**PE1915**  
Lower Ball Joint  
(Ø14.18)



**PE2118**  
Lower Control Arm Bush



**PE2026**  
Lower Control Arm

**PE2027**  
Lower Control Arm

**PE1915**  
Lower Ball Joint  
(Ø14.18)



**PE2117**  
Lower Control Arm Bush



LEFT

RIGHT

**PEUGEOT**

406

FRONT

ALL MODELS

Year

1996-2005

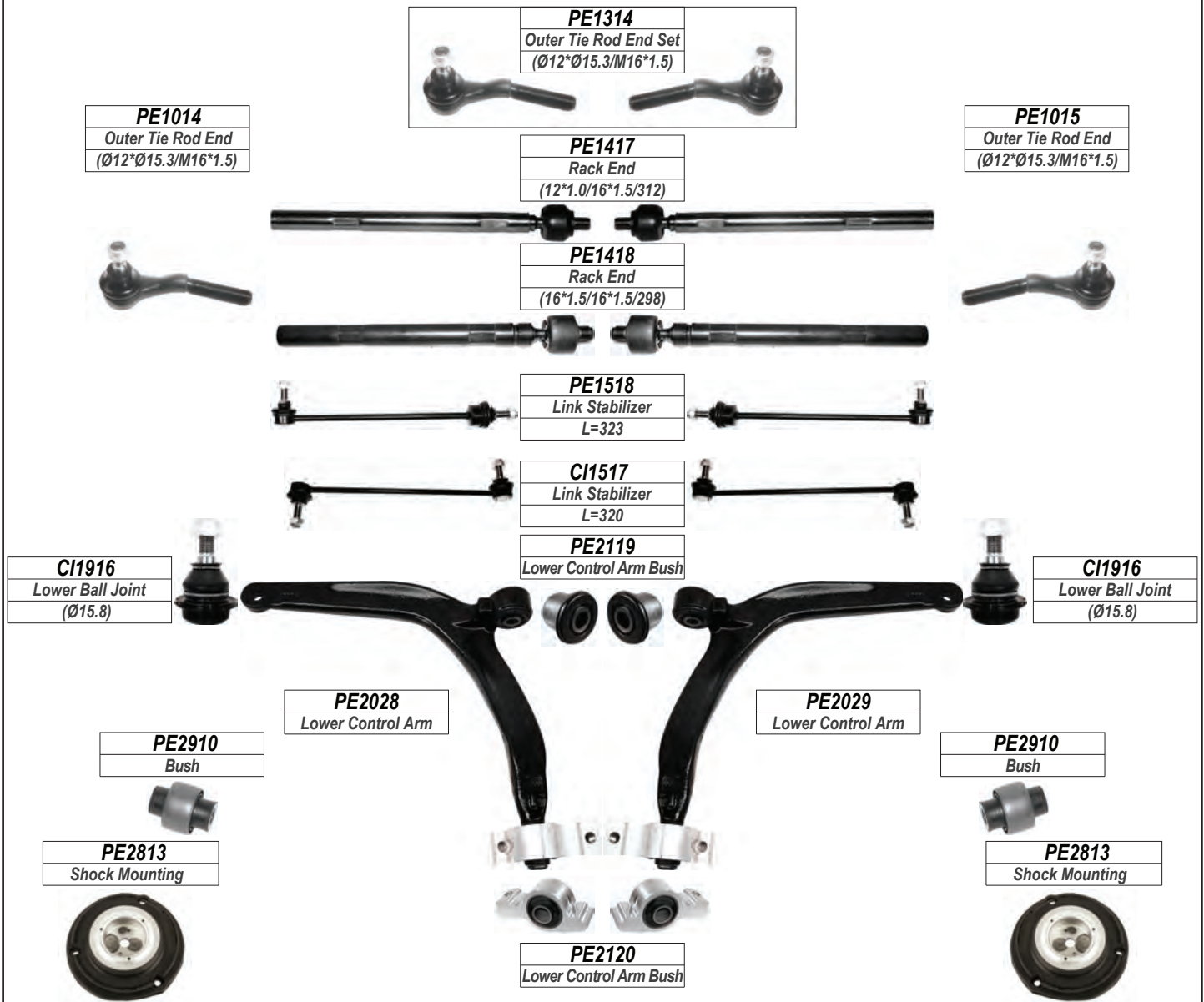

406

REAR



LEFT

RIGHT

**PEUGEOT**

407

FRONT

ALL MODELS

Year

2004-2009

**PE1315**  
Outer Tie Rod End Set  
(Ø12.1\*Ø14.8/M14\*1.5)



**PE1316**  
Outer Tie Rod End Set  
(Ø14.8\*Ø17/M14\*1.5)



**PE1016**  
Outer Tie Rod End  
(Ø12.1\*Ø14.8/M14\*1.5)



**PE1018**  
Outer Tie Rod End  
(Ø14.8\*Ø17/M14\*1.5)



**PE1419**  
Rack End  
(16\*1.5/14\*1.5/105)



**PE1017**  
Outer Tie Rod End  
(Ø12.1\*Ø14.8/M14\*1.5)



**PE1019**  
Outer Tie Rod End  
(Ø14.8\*Ø17/M14\*1.5)



**CI1518 / CI1519**  
Link Stabilizer  
L=200



**CI1610**  
Upper Ball Joint  
(Ø18)



**CI1610**  
Upper Ball Joint  
(Ø18)



**CI1917**  
Lower Ball Joint  
(Ø15.8)



**CI1917**  
Lower Ball Joint  
(Ø15.8)



**CI2124**  
Lower Control Arm Bush



**PE2030**  
Lower Control Arm

**PE2031**  
Lower Control Arm

**PE2121**  
Lower Control Arm Bush



407

REAR

**CI1520**  
Link Stabilizer  
L=141



LEFT

RIGHT

**PEUGEOT**

5008

FRONT

ALL MODELS

Year

2009-

**CI1011**  
Outer Tie Rod End  
(Ø12\*Ø15/M14\*1.5)



**CI1311**  
Outer Tie Rod End Set  
(Ø12\*Ø15/M14\*1.5)

**PE1415**  
Rack End  
(14\*1.5/14\*1.5/277)



**CI1012**  
Outer Tie Rod End  
(Ø12\*Ø15/M14\*1.5)



**PE1514**  
Link Stabilizer  
L=333



**CI1515**  
Link Stabilizer  
L=335



**CI2112**  
Lower Control Arm Bush



**CI1912**  
Lower Ball Joint  
(Ø15.7)



**PE2032**  
Lower Control Arm

**PE2033**  
Lower Control Arm

**CI1912**  
Lower Ball Joint  
(Ø15.7)



**CI2113**  
Lower Control Arm Bush



LEFT

RIGHT



**PEUGEOT**

508

FRONT

ALL MODELS

Year

2011-

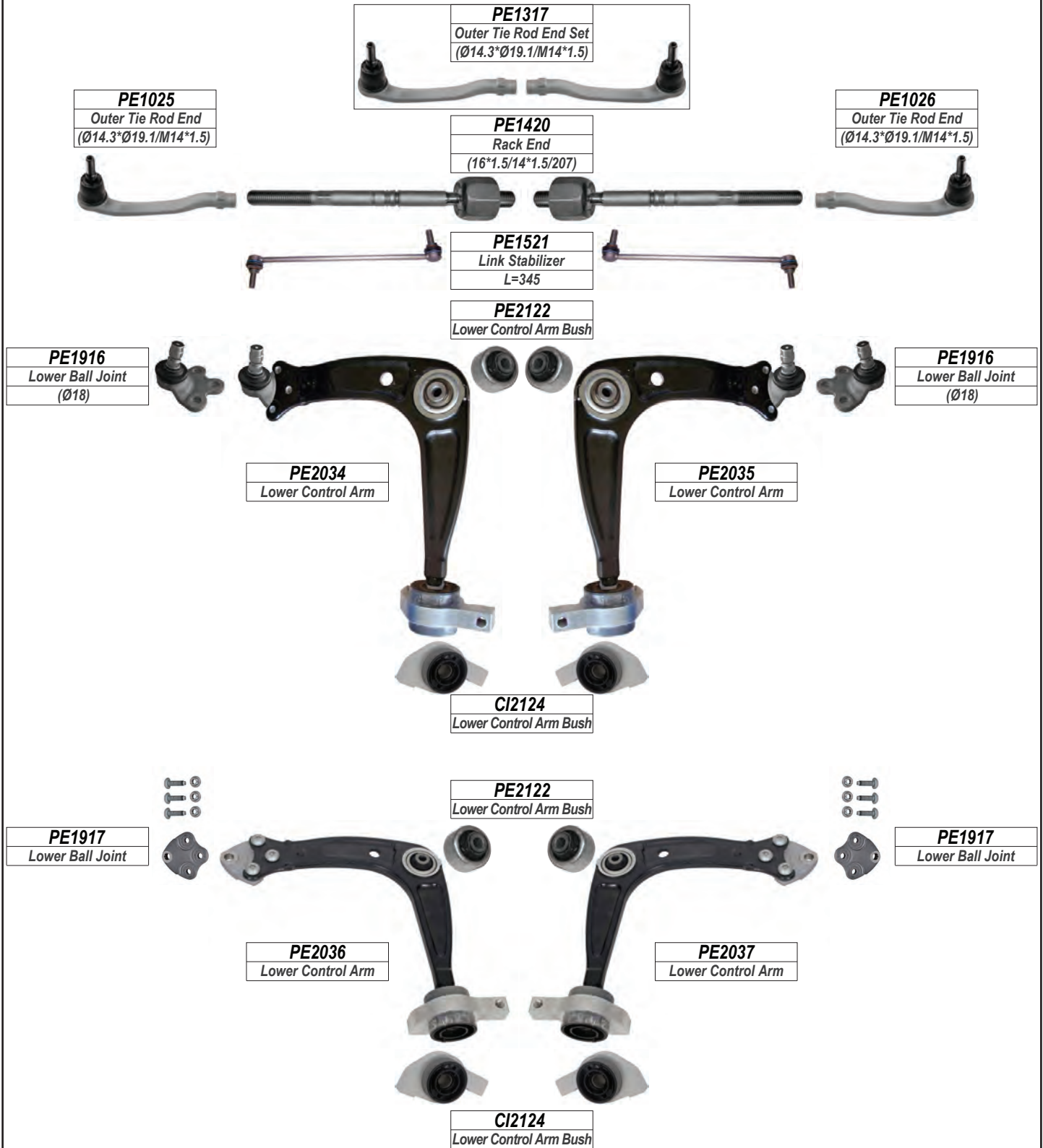

508

REAR

**PE2914**

Bush



LEFT

RIGHT

**PEUGEOT**

607

FRONT

ALL MODELS

Year

2001-2009

**PE1020**  
Outer Tie Rod End  
(Ø11.9\*Ø15.7/M16\*1.5)

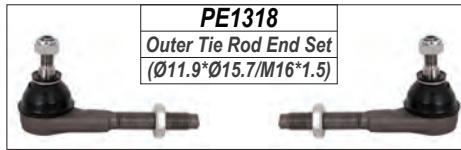

**PE1318**  
Outer Tie Rod End Set  
(Ø11.9\*Ø15.7/M16\*1.5)

**PE1421**  
Rack End  
(16\*1.5/16\*1.5/294)

**PE1021**  
Outer Tie Rod End  
(Ø11.9\*Ø15.7/M16\*1.5)



**PE1518**  
Link Stabilizer  
L=323



**PE1522**  
Link Stabilizer  
L=300



**CI1517**  
Link Stabilizer  
L=320



**PE2123**  
Lower Control Arm Bush



**CI1916**  
Lower Ball Joint  
(Ø15.8)



**PE2038**  
Lower Control Arm

**PE2039**  
Lower Control Arm

**PE2124**  
Lower Control Arm Bush

**CI1916**  
Lower Ball Joint  
(Ø15.8)



607

REAR

**PE1523 / PE1524**  
Link Stabilizer  
L=86



LEFT

RIGHT

**PEUGEOT**

806

FRONT

ALL MODELS

Year

1997-2003

**FI1022**  
Outer Tie Rod End  
(Ø12.65\*Ø14.5/M14\*1.5)

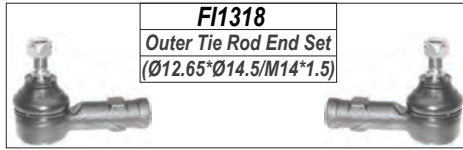

**FI1318**  
Outer Tie Rod End Set  
(Ø12.65\*Ø14.5/M14\*1.5)

**FI1417**  
Rack End  
(16\*1.5/14\*1.5/282)

**FI1022**  
Outer Tie Rod End  
(Ø12.65\*Ø14.5/M14\*1.5)

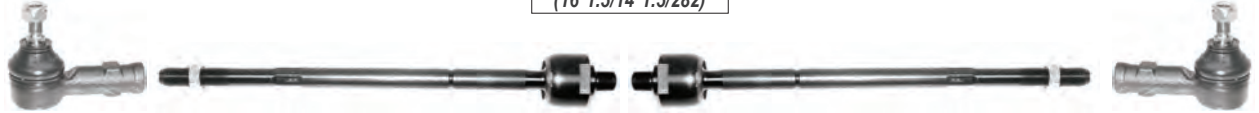

**FI1519**  
Link Stabilizer  
L=122



**FI2132**  
Lower Control Arm Bush



**FI2048**  
Lower Control Arm

**FI2049**  
Lower Control Arm

**FI2133 / FI2134**  
Lower Control Arm Bush

**LEFT**

**RIGHT**

**PEUGEOT**

807

FRONT

ALL MODELS

Year

2002-2007

**F11023**  
Outer Tie Rod End  
(Ø13.6\*Ø15.5/M14\*1.5)

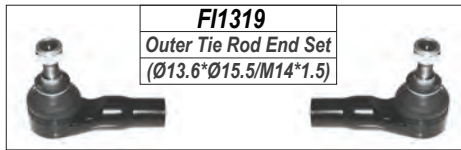

**F11319**  
Outer Tie Rod End Set  
(Ø13.6\*Ø15.5/M14\*1.5)

**F11424**  
Rack End  
(14\*1.5/14\*1.5/313)

**F11023**  
Outer Tie Rod End  
(Ø13.6\*Ø15.5/M14\*1.5)



**F11520**  
Link Stabilizer  
L=263



**F12132**  
Lower Control Arm Bush



**F12050**  
Lower Control Arm

**F12051**  
Lower Control Arm

**F12135 / F12136**  
Lower Control Arm Bush

LEFT

RIGHT

**PEUGEOT**

**BOXER**

**FRONT**

**1.0Q/1.4Q/1.8Q**

*Year*

**1994-2002**

**PE1022**  
Outer Tie Rod End  
(Ø14.5\*Ø16.4/M16\*1.5)

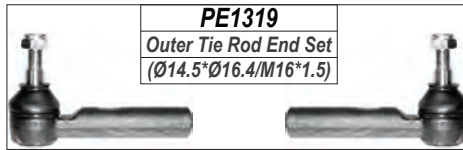

**PE1319**  
Outer Tie Rod End Set  
(Ø14.5\*Ø16.4/M16\*1.5)

**FI1415**  
Rack End  
(16\*1.5/16\*1.5/317)

**PE1022**  
Outer Tie Rod End  
(Ø14.5\*Ø16.4/M16\*1.5)

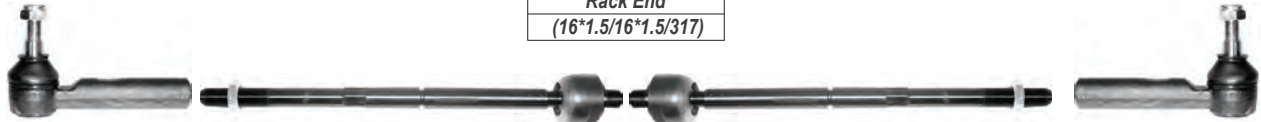

**FI1514**  
Link Stabilizer  
L=134



**FI2123**  
Lower Control Arm Bush



**FI1914**  
Lower Ball Joint  
(Ø16.65)



**FI2028**  
Lower Control Arm

**FI2029**  
Lower Control Arm

**FI1914**  
Lower Ball Joint  
(Ø16.65)



**FI2124**  
Lower Control Arm Bush



**PE1918**  
Lower Ball Joint  
(Ø19.5)



**FI2030**  
Lower Control Arm

**FI2031**  
Lower Control Arm

**FI2123**  
Lower Control Arm Bush



**PE1918**  
Lower Ball Joint  
(Ø19.5)



**FI2124**  
Lower Control Arm Bush



**LEFT**

**RIGHT**



**PEUGEOT**

**BOXER**

**FRONT**

**1.4Q/1.8Q**

*Year*

**2002-2006**

**FI1314**

Outer Tie Rod End Set  
(Ø16.65\*Ø21.35/M16\*1.5)

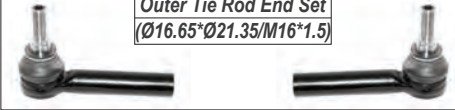

**FI1019**

Outer Tie Rod End  
(Ø16.65\*Ø21.35/M16\*1.5)



**FI1019**

Outer Tie Rod End  
(Ø16.65\*Ø21.35/M16\*1.5)



**FI1415**

Rack End  
(16\*1.5/16\*1.5/317)



**FI1514**

Link Stabilizer  
L=134



**FI2123**

Lower Control Arm Bush



**FI1914**

Lower Ball Joint  
(Ø16.65)



**FI2028**  
Lower Control Arm

**FI1914**

Lower Ball Joint  
(Ø16.65)



**FI2029**  
Lower Control Arm

**FI2124**

Lower Control Arm Bush

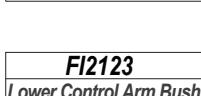

**FI1915**

Lower Ball Joint  
(Ø19.5)



**FI2030**  
Lower Control Arm

**FI1915**

Lower Ball Joint  
(Ø19.5)



**FI2031**  
Lower Control Arm

**PE2814**

Shock Mounting



**FI2124**

Lower Control Arm Bush



**PE2815**

Shock Mounting



**LEFT**

**RIGHT**

**PEUGEOT**

**BOXER**

**FRONT**

**ALL MODELS**

*Year*

**2006-**

**CI1027**  
Outer Tie Rod End  
(Ø16.65\*Ø21.4/M16\*1.5)

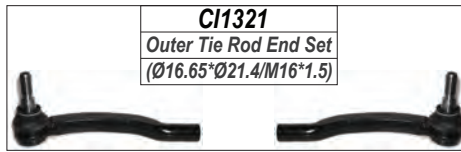

**CI1321**  
Outer Tie Rod End Set  
(Ø16.65\*Ø21.4/M16\*1.5)

**CI1419**  
Rack End  
(16\*1.5/16\*1.5/260)



**CI1028**  
Outer Tie Rod End  
(Ø16.65\*Ø21.4/M16\*1.5)



**CI1521**  
Link Stabilizer  
L=112



**CI2126**  
Lower Control Arm Bush



**CI1918**  
Lower Ball Joint  
(Ø20.55)



**CI1918**  
Lower Ball Joint  
(Ø20.55)



**CI2028**  
Lower Control Arm



**CI2029**  
Lower Control Arm

**CI2127**  
Lower Control Arm Bush



**BOXER**

**REAR**

**CI1522**  
Link Stabilizer  
L=100



**LEFT**

**RIGHT**

**PEUGEOT**

**EXPERT**

**FRONT**

**ALL MODELS**

*Year*

**1995-**

**FI1022**  
Outer Tie Rod End  
(Ø12.65\*Ø14.5/M14\*1.5)

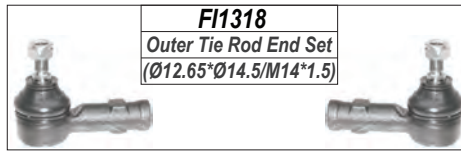

**FI1318**  
Outer Tie Rod End Set  
(Ø12.65\*Ø14.5/M14\*1.5)

**FI1417**  
Rack End  
(16\*1.5/14\*1.5/282)

**FI1022**  
Outer Tie Rod End  
(Ø12.65\*Ø14.5/M14\*1.5)



**FI1519**  
Link Stabilizer  
L=122



**FI2132**  
Lower Control Arm Bush



**FI2048**  
Lower Control Arm

**FI2049**  
Lower Control Arm

**FI2133 / FI2134**  
Lower Control Arm Bush

**LEFT**

**RIGHT**

**PEUGEOT**

**EXPERT**

**FRONT**

**ALL MODELS**

Year

**2007-**

**FI1024**  
Outer Tie Rod End  
(Ø14.5\*Ø18.3/M14\*1.5)

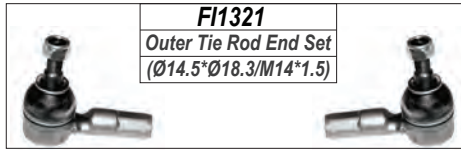

**FI1321**  
Outer Tie Rod End Set  
(Ø14.5\*Ø18.3/M14\*1.5)

**PE1422**  
Rack End  
(16\*1.5/14\*1.5/305)



**FI1024**  
Outer Tie Rod End  
(Ø14.5\*Ø18.3/M14\*1.5)



**PE1525**  
Link Stabilizer  
L=263



**PE2125**  
Lower Control Arm Bush



**PE2040**  
Lower Control Arm

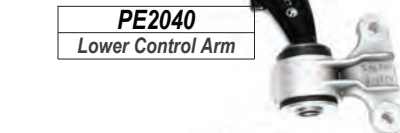

**PE2041**  
Lower Control Arm



**FI2135 / FI2136**  
Lower Control Arm Bush



**LEFT**

**RIGHT**

**PEUGEOT**

**PARTNER**

**FRONT**

**ALL MODELS**

*Year*

**1998-2008**

**CI1010**  
Outer Tie Rod End  
(Ø12.1\*Ø15.85/M14\*1.5)

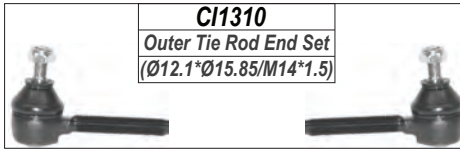

**CI1310**  
Outer Tie Rod End Set  
(Ø12.1\*Ø15.85/M14\*1.5)

**CI1410**  
Rack End  
(12\*1.0 /14\*1.5/335)

**CI1010**  
Outer Tie Rod End  
(Ø12.1\*Ø15.85/M14\*1.5)



**CI1422**  
Rack End  
(12\*1.0/14\*1.5/338)



**CI1510**  
Link Stabilizer  
L=300



**CI1911**  
Lower Ball Joint  
(Ø18)



**CI2110**  
Lower Control Arm Bush



**CI1911**  
Lower Ball Joint  
(Ø18)



**CI2010**  
Lower Control Arm



**CI2011**  
Lower Control Arm



**CI2111**  
Lower Control Arm Bush



**CI2110**  
Lower Control Arm Bush



**PE1920**  
Lower Ball Joint  
(Ø16)



**PE1920**  
Lower Ball Joint  
(Ø16)



**PE2042**  
Lower Control Arm



**PE2043**  
Lower Control Arm



**CI2111**  
Lower Control Arm Bush



**LEFT**

**RIGHT**



**PEUGEOT**

**PARTNER**

**FRONT**

**ALL MODELS**

*Year*

**1998-2008**

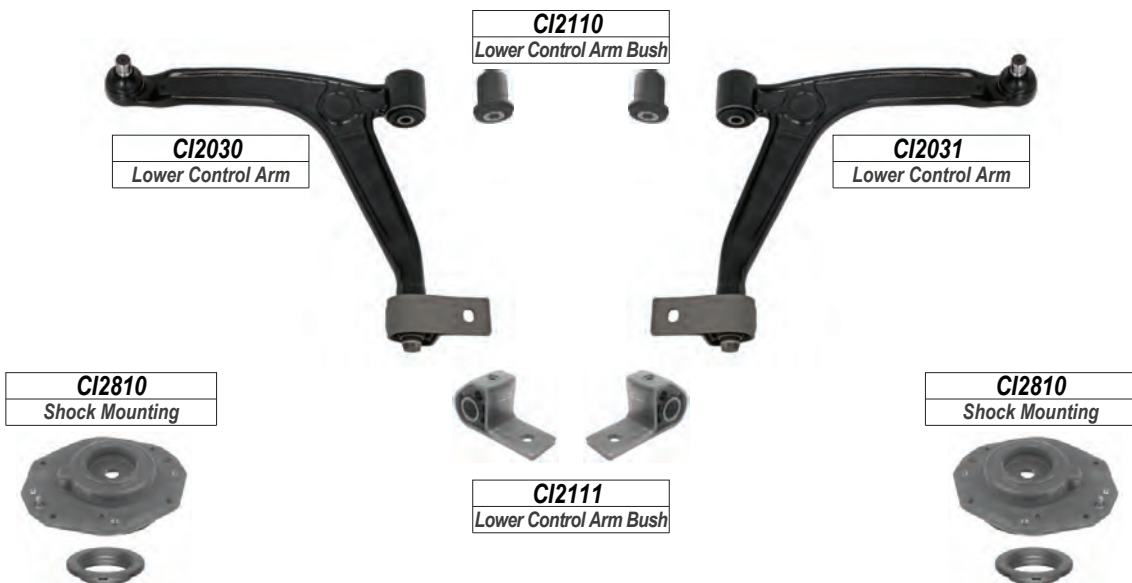
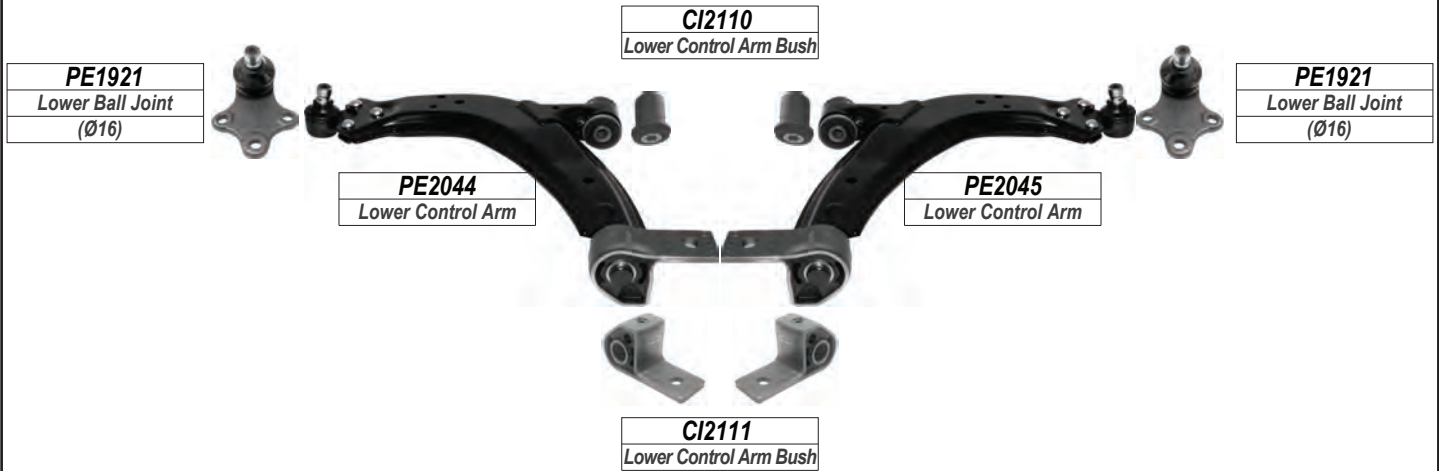

**LEFT**

**RIGHT**

**PEUGEOT**

**PARTNER TEPE**

**FRONT**

**ALL MODELS**

Year

**2008-**

**CI1011**  
Outer Tie Rod End  
(Ø12\*Ø15/M14\*1.5)



**CI1311**  
Outer Tie Rod End Set  
(Ø12\*Ø15/M14\*1.5)

**CI1411**  
Rack End  
(14\*1.5/14\*1.5/262)



**CI1012**  
Outer Tie Rod End  
(Ø12\*Ø15/M14\*1.5)



**CI1511**  
Link Stabilizer  
L=334



**PE1526**  
Link Stabilizer  
L=335 (Aluminium)



**CI2112**  
Lower Control Arm Bush



**CI1912**  
Lower Ball Joint  
(Ø15.7)



**CI1912**  
Lower Ball Joint  
(Ø15.7)



**CI2012**  
Lower Control Arm



**CI2013**  
Lower Control Arm

**CI2811**  
Shock Mounting



**CI2113**  
Lower Control Arm Bush



**CI2811**  
Shock Mounting



**LEFT**

**RIGHT**

**PORSCHE**

CAYENNE

FRONT

ALL MODELS

Year

2002-2010

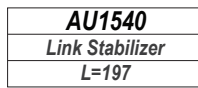
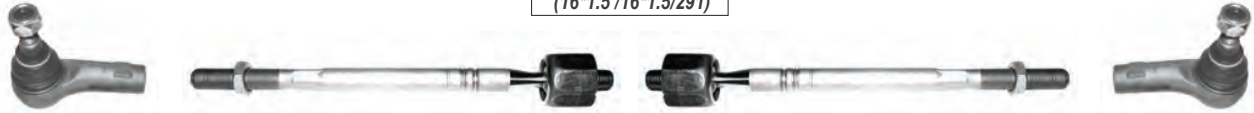
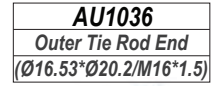
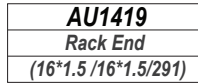
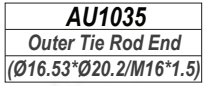
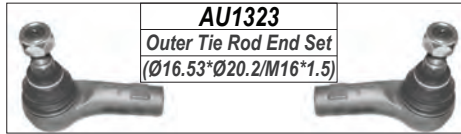

**LEFT**

**RIGHT**

**PORSCHE**

CAYENNE

FRONT

ALL MODELS

Year

2002-2010



S3

REAR

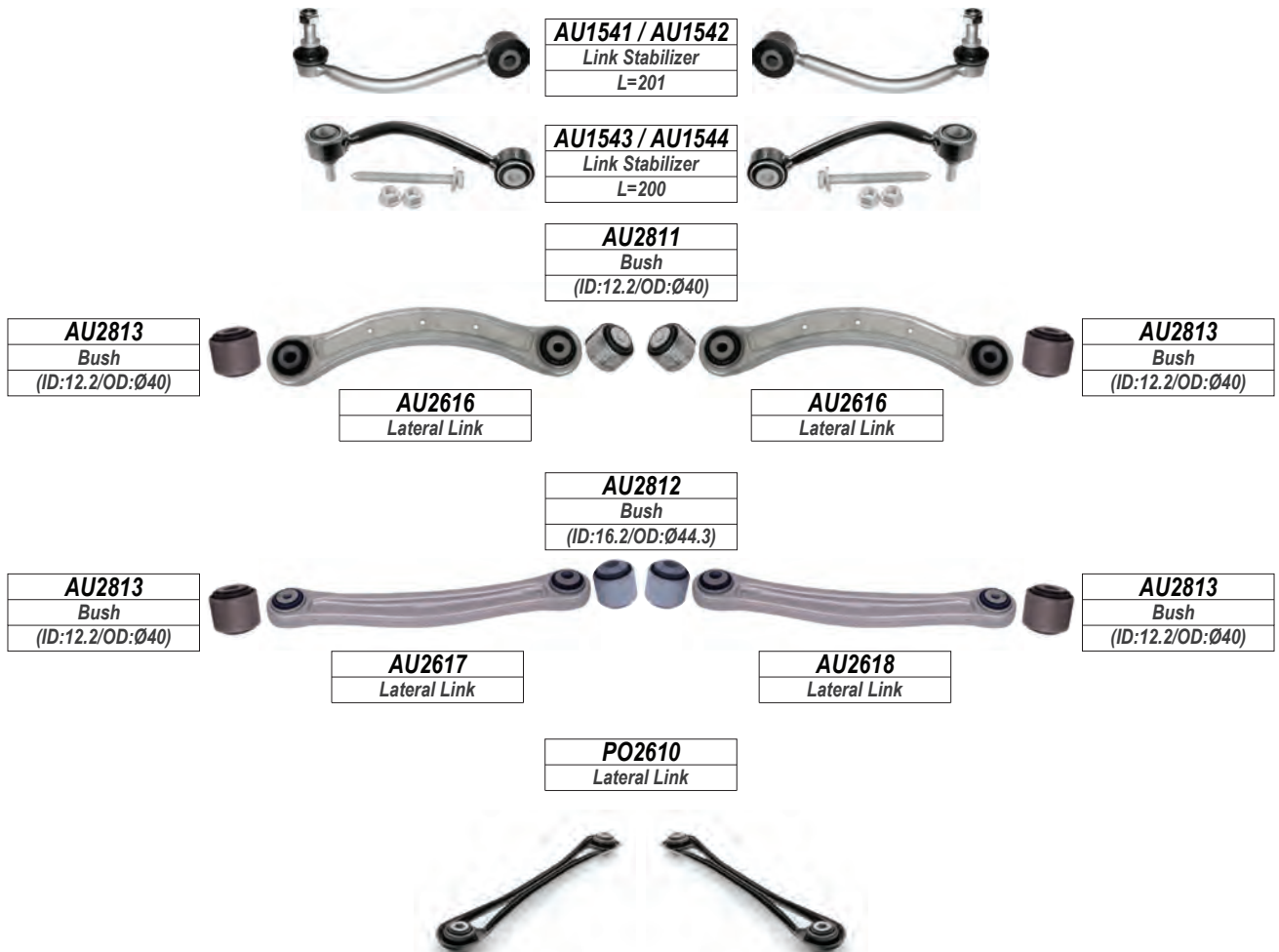

LEFT

RIGHT

**PORSCHE**

CAYENNE

FRONT

ALL MODELS

Year

2010-

**AU1035**  
Outer Tie Rod End  
(Ø16.53\*Ø20.2/M16\*1.5)

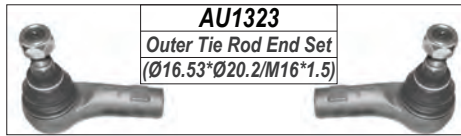

**AU1323**  
Outer Tie Rod End Set  
(Ø16.53\*Ø20.2/M16\*1.5)

**AU1419**  
Rack End  
(16\*1.5 /16\*1.5/291)

**AU1036**  
Outer Tie Rod End  
(Ø16.53\*Ø20.2/M16\*1.5)



**AU1540**  
Link Stabilizer  
L=197



**PO1810**  
Upper Control Arm Bush

**PO1710**  
Upper Control Arm

**PO1710**  
Upper Control Arm

**AU2135**  
Lower Control Arm Bush

**AU2136**  
Lower Control Arm Bush

**AU2136**  
Lower Control Arm Bush



**AU2074**  
Lower Control Arm

**AU2075**  
Lower Control Arm

**AU2138**  
Lower Control Arm Bush

LEFT

RIGHT



**PORSCHE**

**CAYENNE**

**REAR**

**ALL MODELS**

*Year*

**2010-**

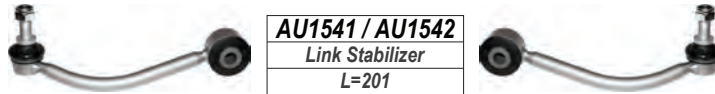

**AU1541 / AU1542**  
Link Stabilizer  
L=201

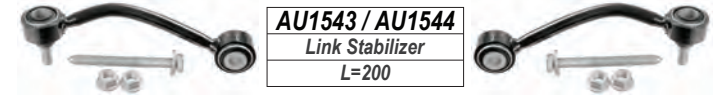

**AU1543 / AU1544**  
Link Stabilizer  
L=200

**AU2811**  
Bush  
(ID:12.2/OD:Ø40)



**AU2616**  
Lateral Link

**AU2616**  
Lateral Link

**AU2813**  
Bush  
(ID:12.2/OD:Ø40)

**AU2813**  
Bush  
(ID:12.2/OD:Ø40)

**AU2812**  
Bush  
(ID:16.2/OD:Ø44.3)



**AU2617**  
Lateral Link

**AU2618**  
Lateral Link

**AU2813**  
Bush  
(ID:12.2/OD:Ø40)

**AU2813**  
Bush  
(ID:12.2/OD:Ø40)

**LEFT**

**RIGHT**

**PORSCHE**

PANAMERA

FRONT

ALL MODELS

Year

2009-

**PO1310**  
Outer Tie Rod End Set  
(Ø16.82\*Ø21.2/M14\*1.5)



**PO1010**  
Outer Tie Rod End  
(Ø16.82\*Ø21.2/M14\*1.5)



**PO1410**  
Rack End  
(16\*1.5 /14\*1.5/204)



**PO1011**  
Outer Tie Rod End  
(Ø16.82\*Ø21.2/M14\*1.5)



**PO1510**  
Link Stabilizer  
L=158



**PO1511**  
Link Stabilizer  
L=160



**AU1813**  
Upper Control Arm Bush



**PO1711**  
Upper Control Arm

**PO1711**  
Upper Control Arm

**PO2111**  
Lower Control Arm Bush

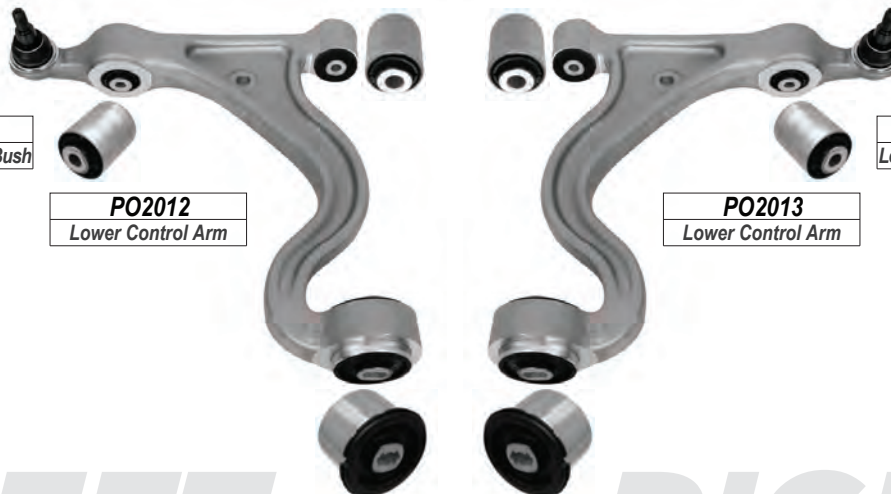

**PO2112**  
Lower Control Arm Bush

**PO2012**  
Lower Control Arm

**PO2112**  
Lower Control Arm Bush

**PO2013**  
Lower Control Arm

**PO2110**  
Lower Control Arm Bush

LEFT

RIGHT

**PORSCHE**

**PANAMERA**

**REAR**

**ALL MODELS**

*Year*

**2009-**

**PO1512**  
Link Stabilizer  
L=200



**PO2910**  
Bush

**PO2910**  
Bush



**PO2910**  
Bush

**PO2611**  
Lateral Link

**PO2611**  
Lateral Link

**PO2910**  
Bush

**PO2910**  
Bush



**PO2910**  
Bush

**PO2612**  
Lateral Link

**PO2612**  
Lateral Link

**LEFT**

**RIGHT**

**PROTON**

GEN 2. PERSONA FRONT

ALL MODELS

Year

2004-

**MI1319**

Outer Tie Rod End Set  
(Ø13.5\*Ø15/M12\*1.25)

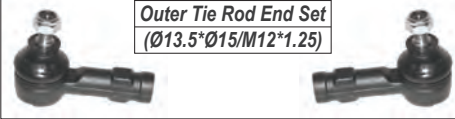

**MI1014**

Outer Tie Rod End  
(Ø13.5\*Ø15/M12\*1.25)



**PR1410**

Rack End  
(14\*1.5/12\*1.25/313)



**MI1014**

Outer Tie Rod End  
(Ø13.5\*Ø15/M12\*1.25)



**PR1510**

Link Stabilizer  
L=113



**PR1910**

Lower Ball Joint  
(Ø15)



**PR1910**

Lower Ball Joint  
(Ø15)



**PR2010**

Lower Control Arm

**PR2011**

Lower Control Arm

**LEFT**

**RIGHT**

**RENAULT**

9.11

FRONT

ALL MODELS

Year

1981-2000

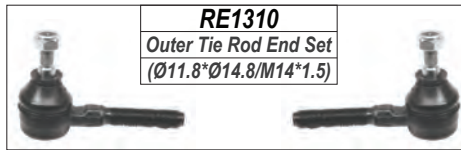

**RE1010**  
Outer Tie Rod End  
(Ø11.8\*Ø14.8/M14\*1.5)

**RE1410**  
Rack End  
(12\*1.0/14\*1.5/176)

**RE1010**  
Outer Tie Rod End  
(Ø11.8\*Ø14.8/M14\*1.5)



**RE2110**  
Lower Control Arm Bush

**RE1910**  
Lower Ball Joint  
(Ø16)



**RE1910**  
Lower Ball Joint  
(Ø16)



**RE2010**  
Lower Control Arm

**RE2011**  
Lower Control Arm

LEFT

RIGHT



**RENAULT**

**CAPTUR**

**FRONT**

**ALL MODELS**

Year

2014-

**RE1011**  
Outer Tie Rod End  
(Ø11.9\*Ø14.5/M14\*1.5)



**RE1311**  
Outer Tie Rod End Set  
(Ø11.9\*Ø14.5/M14\*1.5)

**RE1411**  
Rack End  
(16\*1.5/14\*1.5/224)



**RE1012**  
Outer Tie Rod End  
(Ø11.9\*Ø14.5/M14\*1.5)



**NI1522**  
Link Stabilizer  
L=248



**RE2111**  
Lower Control Arm Bush



**NI1931**  
Lower Ball Joint  
(Ø18)



**NI1931**  
Lower Ball Joint  
(Ø18)



**RE2012**  
Lower Control Arm



**RE2013**  
Lower Control Arm



**NI2122**  
Lower Control Arm Bush



**LEFT**

**RIGHT**

**RENAULT**

CLIO I

FRONT

ALL MODELS

Year

1990-2001

**RE1013**  
Outer Tie Rod End  
(Ø11.9\*Ø14.5/M14\*1.5)

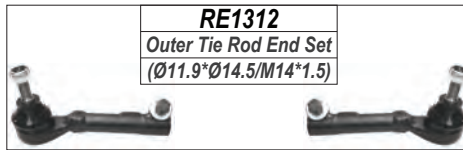

**RE1312**  
Outer Tie Rod End Set  
(Ø11.9\*Ø14.5/M14\*1.5)

**RE1412**  
Rack End  
(12\*1.0/14\*1.5/242)

**RE1014**  
Outer Tie Rod End  
(Ø11.9\*Ø14.5/M14\*1.5)



**RE1910**  
Lower Ball Joint  
(Ø16)



**RE2112**  
Lower Control Arm Bush

**RE1910**  
Lower Ball Joint  
(Ø16)



**RE2014**  
Lower Control Arm

**RE2015**  
Lower Control Arm

**NI2814**  
Shock Mounting



**NI2815**  
Shock Mounting



LEFT

RIGHT

**RENAULT**

CLIO II

FRONT

ALL MODELS

Year

2001-2009

**NI1018**  
Outer Tie Rod End  
(Ø11.8\*Ø14.8/M14\*1.5)

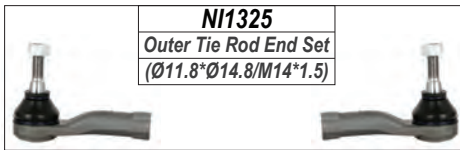

**NI1325**  
Outer Tie Rod End Set  
(Ø11.8\*Ø14.8/M14\*1.5)

**RE1413**  
Rack End  
(14\*1.5/14\*1.5/291)

**NI1030**  
Outer Tie Rod End  
(Ø11.8\*Ø14.8/M14\*1.5)



**RE1015**  
Outer Tie Rod End  
(Ø11.8\*Ø14.8/M14\*1.5)



**RE1414**  
Rack End  
(12\*1.0/14\*1.5/302)

**RE1415**  
Rack End  
(12\*1.0/14\*1.5/303)

**RE1016**  
Outer Tie Rod End  
(Ø11.8\*Ø14.8/M14\*1.5)



**RE1910**  
Lower Ball Joint  
(Ø16)(10.5mm Hole)

**RE2113**  
Lower Control Arm Bush



**RE1910**  
Lower Ball Joint  
(Ø16)(10.5mm Hole)



**RE1911**  
Lower Ball Joint  
(Ø16)(12.5mm Hole)



**RE2016**  
Lower Control Arm

**RE2017**  
Lower Control Arm

**RE2819**  
Shock Mounting



**RE2710**  
Repair Kit



**RE2710**  
Repair Kit



**RE2819**  
Shock Mounting



**NI2814**  
Shock Mounting



**NI2815**  
Shock Mounting



LEFT

RIGHT

**RENAULT**

CLIO III

FRONT

ALL MODELS

Year

2005-2012

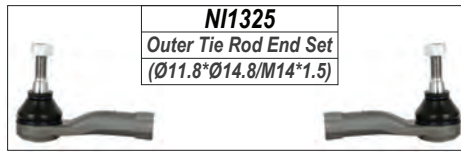

**NI1325**  
Outer Tie Rod End Set  
(Ø11.8\*Ø14.8/M14\*1.5)

**NI1018**  
Outer Tie Rod End  
(Ø11.8\*Ø14.8/M14\*1.5)



**NI1419**  
Rack End  
(14\*1.5/14\*1.5/308)

**NI1030**  
Outer Tie Rod End  
(Ø11.8\*Ø14.8/M14\*1.5)



**NI1522**  
Link Stabilizer  
L=248



**NI2117**  
Lower Control Arm Bush

**NI1931**  
Lower Ball Joint  
(Ø18)



**NI2040**  
Lower Control Arm

**NI2041**  
Lower Control Arm

**NI1931**  
Lower Ball Joint  
(Ø18)



**NI2118**  
Lower Control Arm Bush



**NI2814**  
Shock Mounting



**NI2815**  
Shock Mounting



**NI2911**  
Stabilizer Bar Bush



**NI2814**  
Shock Mounting



**NI2815**  
Shock Mounting



LEFT

RIGHT

**RENAULT**

CLIO IV

FRONT

ALL MODELS

Year

2013-

**RE1311**  
Outer Tie Rod End Set  
( $\varnothing 11.9 \times \varnothing 14.5 / M14 \times 1.5$ )



**RE1011**  
Outer Tie Rod End  
( $\varnothing 11.9 \times \varnothing 14.5 / M14 \times 1.5$ )



**RE1411**  
Rack End  
( $16 \times 1.5 / 14 \times 1.5 / 232$ )



**RE1012**  
Outer Tie Rod End  
( $\varnothing 11.9 \times \varnothing 14.5 / M14 \times 1.5$ )



**NI1522**  
Link Stabilizer  
L=248



**RE2111**  
Lower Control Arm Bush



**NI1931**  
Lower Ball Joint  
( $\varnothing 18$ )



**NI1931**  
Lower Ball Joint  
( $\varnothing 18$ )



**RE2018**  
Lower Control Arm



**RE2019**  
Lower Control Arm

**NI2122**  
Lower Control Arm Bush



**RE2815**  
Shock Mounting



**RE2815**  
Shock Mounting



LEFT

RIGHT



**RENAULT**

**DUSTER**

**FRONT**

**ALL MODELS**

Year

**2010-**

**RE1314**  
Outer Tie Rod End Set  
(Ø11.9\*Ø14.8/M14\*1.5)



**RE1017**  
Outer Tie Rod End  
(Ø11.9\*Ø14.8/M14\*1.5)



**RE1416**  
Rack End  
(16\*1.5/14\*1.5/203)



**RE1018**  
Outer Tie Rod End  
(Ø11.9\*Ø14.8/M14\*1.5)



**RE1510**  
Link Stabilizer  
L=294



**RE2114**  
Lower Control Arm Bush



**RE1912**  
Lower Ball Joint  
(Ø17.2)



**RE1912**  
Lower Ball Joint  
(Ø17.2)



**RE2020**  
Lower Control Arm

**RE2021**  
Lower Control Arm

**NI2821**  
Shock Mounting



**RE2810**  
Stabilizer Bar Bush



**NI2821**  
Shock Mounting



**DUSTER**

**REAR**

**RE2910**  
Bush



**LEFT**

**RIGHT**

**RENAULT**

ESPACE

FRONT

III

Year

1996-2002

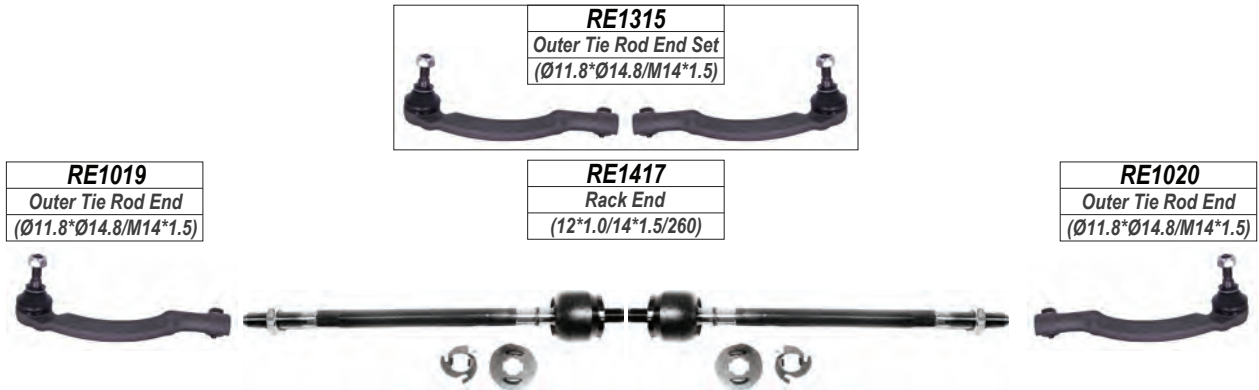

LEFT

RIGHT

**RENAULT**

SPACE

FRONT

IV

Year

2002-

**NI1335**  
Outer Tie Rod End Set  
(Ø12\*Ø14.6/M14\*1.5)



**NI1041**  
Outer Tie Rod End  
(Ø12\*Ø14.6/M14\*1.5)



**RE1418**  
Rack End  
(12\*1.0/14\*1.5/248)



**NI1042**  
Outer Tie Rod End  
(Ø12\*Ø14.6/M14\*1.5)



**NI1536**  
Link Stabilizer  
L=279



**NI2123**  
Lower Control Arm Bush



**RE2024**  
Lower Control Arm

**RE2025**  
Lower Control Arm

**RE2117**  
Lower Control Arm Bush

**NI1921**  
Lower Ball Joint  
(Ø17.84)



**NI1921**  
Lower Ball Joint  
(Ø17.84)



**NI2123**  
Lower Control Arm Bush



**NI2044**  
Lower Control Arm

**NI2045**  
Lower Control Arm

**RE2117**  
Lower Control Arm Bush

LEFT

RIGHT

**RENAULT**

FLUENCE

FRONT

ALL MODELS

Year

2011-

**NI1335**  
Outer Tie Rod End Set  
(Ø12\*Ø14.6/M14\*1.5)



**NI1041**  
Outer Tie Rod End  
(Ø12\*Ø14.6/M14\*1.5)

**RE1419**  
Rack End  
(14\*1.5/14\*1.5/209)

**NI1042**  
Outer Tie Rod End  
(Ø12\*Ø14.6/M14\*1.5)



**RE1512**  
Link Stabilizer  
L=264



**RE2119**  
Lower Control Arm Bush

**RE1914**  
Lower Ball Joint  
(Ø17.2)



**RE1914**  
Lower Ball Joint  
(Ø17.2)

**RE2026**  
Lower Control Arm

**RE2027**  
Lower Control Arm

**RE2118**  
Lower Control Arm Bush

**RE2811**  
Stabilizer Bar Bush  
ID:20



**RE2812**  
Stabilizer Bar Bush  
ID:22.5



**RE2816**  
Shock Mounting



**RE2816**  
Shock Mounting



LEFT

RIGHT

**RENAULT**

GRAND SCENIC

FRONT

II

Year

2004-2009

**RE1316**  
Outer Tie Rod End Set  
(Ø11.8\*Ø14.8/M14\*1.5)



**RE1021**  
Outer Tie Rod End  
(Ø11.8\*Ø14.8/M14\*1.5)



**RE1420**  
Rack End  
(14\*1.5/14\*1.5/217)



**RE1022**  
Outer Tie Rod End  
(Ø11.8\*Ø14.8/M14\*1.5)



**RE1513**  
Link Stabilizer  
L=266



**RE1514**  
Link Stabilizer  
L=283



**NI1931**  
Lower Ball Joint  
(Ø18)



**RE2111**  
Lower Control Arm Bush



**NI1931**  
Lower Ball Joint  
(Ø18)



**RE2012**  
Lower Control Arm



**RE2013**  
Lower Control Arm



**NI2122**  
Lower Control Arm Bush

**RE2111**  
Lower Control Arm Bush



**RE1915**  
Lower Ball Joint  
(Ø16)



**RE1915**  
Lower Ball Joint  
(Ø16)



**RE2028**  
Lower Control Arm



**RE2029**  
Lower Control Arm



**RE2817**  
Shock Mounting



**NI2122**  
Lower Control Arm Bush



**RE2817**  
Shock Mounting



LEFT

RIGHT



**RENAULT**

GRAND SCENIC

FRONT

III

Year

2010-

**RE1317**  
Outer Tie Rod End Set  
(Ø11.85\*Ø14.7/M14\*1.5)



**RE1023**  
Outer Tie Rod End  
(Ø11.85\*Ø14.7/M14\*1.5)



**RE1419**  
Rack End  
(14\*1.5/14\*1.5/209)



**RE1024**  
Outer Tie Rod End  
(Ø11.85\*Ø14.7/M14\*1.5)



**RE1515**  
Link Stabilizer  
L=274



**RE2119**  
Lower Control Arm Bush



**RE2026**  
Lower Control Arm

**RE2027**  
Lower Control Arm

**RE2118**  
Lower Control Arm Bush

**RE2119**  
Lower Control Arm Bush



**RE2030**  
Lower Control Arm

**RE2031**  
Lower Control Arm

**RE2130**  
Lower Control Arm Bush

**RE2818**  
Shock Mounting



**RE2818**  
Shock Mounting



**RE2811**  
Stabilizer Bar Bush  
ID:20



**RE2812**  
Stabilizer Bar Bush  
ID:22.5



LEFT

RIGHT

**RENAULT**

**KADJAR**

**FRONT**

**ALL MODELS**

*Year*

**2016-**

**NI1046**  
Outer Tie Rod End  
(Ø11.8\*Ø14.6/M14\*1.5)



**NI1338**  
Outer Tie Rod End Set  
(Ø11.8\*Ø14.6/M14\*1.5)

**RE1420**  
Rack End  
(16\*1.5/14\*1.5/229)



**NI1047**  
Outer Tie Rod End  
(Ø11.8\*Ø14.6/M14\*1.5)



**NI1517**  
Link Stabilizer  
L=284



**NI1930**  
Lower Ball Joint  
(Ø20)



**NI2128**  
Lower Control Arm Bush



**NI2052**  
Lower Control Arm

**NI2053**  
Lower Control Arm

**NI1930**  
Lower Ball Joint  
(Ø20)

**NI2129**  
Lower Control Arm Bush

**LEFT**

**RIGHT**

**RENAULT**

**KANGOO**

**FRONT**

Year

1999-2009

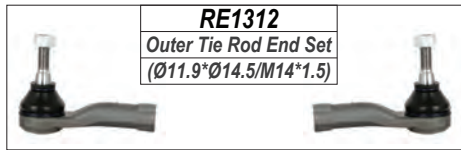

**RE1312**  
Outer Tie Rod End Set  
(Ø11.9\*Ø14.5/M14\*1.5)

**RE1013**  
Outer Tie Rod End  
(Ø11.9\*Ø14.5/M14\*1.5)



**RE1414**  
Rack End  
(12\*1.0/14\*1.5/304)

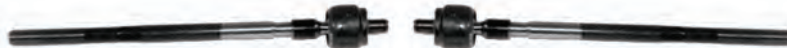

**RE1014**  
Outer Tie Rod End  
(Ø11.9\*Ø14.5/M14\*1.5)



**RE1313**  
Outer Tie Rod End Set  
(Ø11.8\*Ø14.8/M14\*1.5)

**RE1015**  
Outer Tie Rod End  
(Ø11.8\*Ø14.8/M14\*1.5)



**RE1415**  
Rack End  
(12\*1.0/14\*1.5/303)



**RE1016**  
Outer Tie Rod End  
(Ø11.8\*Ø14.8/M14\*1.5)



**RE1422**  
Rack End  
(12\*1.0/14\*1.5/264)



**RE1423**  
Rack End  
(12\*1.0/14\*1.5/261)



**RE1910**  
Lower Ball Joint  
(Ø16)(10.5mm Hole)



**RE2113**  
Lower Control Arm Bush



**RE2016**  
Lower Control Arm

**RE2017**  
Lower Control Arm

**RE1910**  
Lower Ball Joint  
(Ø16)(10.5mm Hole)



**RE1911**  
Lower Ball Joint  
(Ø16)(12.5mm Hole)



**RE1911**  
Lower Ball Joint  
(Ø16)(12.5mm Hole)



**RE2710**  
Repair Kit



**RE2710**  
Repair Kit



**RE2819**  
Shock Mounting



**RE2819**  
Shock Mounting



**LEFT**

**RIGHT**

**RENAULT**

**KANGOO**

**FRONT**

**II**

*Year*

**2008-**

**RE1318**  
Outer Tie Rod End Set  
(Ø11.85\*Ø14.7/M14\*1.5)



**RE1025**  
Outer Tie Rod End  
(Ø11.85\*Ø14.7/M14\*1.5)



**RE1424**  
Rack End  
(14\*1.5/14\*1.5/214)



**RE1026**  
Outer Tie Rod End  
(Ø11.85\*Ø14.7/M14\*1.5)



**RE1419**  
Rack End  
(14\*1.5/14\*1.5/209)



**RE1514**  
Link Stabilizer  
L=283



**RE2120**  
Lower Control Arm Bush



**RE1916**  
Lower Ball Joint  
(Ø20)



**RE1917**  
Lower Ball Joint  
(Ø20)



**RE2032**  
Lower Control Arm



**RE2033**  
Lower Control Arm



**RE2121**  
Lower Control Arm Bush



**RE2819**  
Shock Mounting



**RE2819**  
Shock Mounting



**LEFT**

**RIGHT**

**RENAULT**

**KOLEOS**

**FRONT**

**ALL MODELS**

*Year*

**2008-**

**RE1319**  
Outer Tie Rod End Set  
(Ø11.7\*Ø14.8/M14\*1.5)

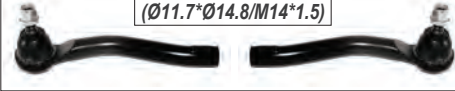

**RE1027**  
Outer Tie Rod End  
(Ø11.7\*Ø14.8/M14\*1.5)



**NI1428**  
Rack End  
(22\*1.5/14\*1.5/233)



**RE1028**  
Outer Tie Rod End  
(Ø11.7\*Ø14.8/M14\*1.5)



**NI1527 / NI1528**  
Link Stabilizer  
L=300



**NI1930**  
Lower Ball Joint  
(Ø20)



**NI2127**  
Lower Control Arm Bush



**NI1930**  
Lower Ball Joint  
(Ø20)



**NI2050**  
Lower Control Arm

**NI2051**  
Lower Control Arm

**NI2114**  
Lower Control Arm Bush



**NI2822**  
Shock Mounting



**NI2823**  
Shock Mounting



**KOLEOS**

**REAR**

**NI1539 / NI1540**  
Link Stabilizer  
L=143.5



**LEFT**

**RIGHT**



**RENAULT**

**KWID**

**FRONT**

**ALL MODELS**

**Year**

**2017-**

**RE1320**  
Outer Tie Rod End Set

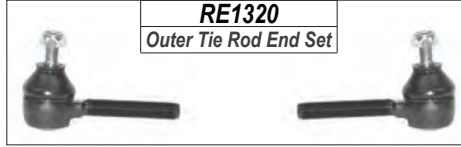

**RE1035**  
Outer Tie Rod End

**RE1035**  
Outer Tie Rod End

**RE1431**  
Rack End



**RE2128**  
Lower Control Arm Bush

**RE1922**  
Lower Ball Joint

**RE1922**  
Lower Ball Joint



**RE2046**  
Lower Control Arm

**RE2047**  
Lower Control Arm

**RE2129**  
Lower Control Arm Bush

**LEFT**

**RIGHT**

**RENAULT**

LAGUNA

FRONT

ALL MODELS

Year

1996-2001

**RE1321**  
Outer Tie Rod End Set  
(Ø11.8\*Ø14.8/M14\*1.5)



**RE1029**  
Outer Tie Rod End  
(Ø11.8\*Ø14.8/M14\*1.5)



**RE1425**  
Rack End  
(12\*1.0/14\*1.5/267)



**RE1030**  
Outer Tie Rod End  
(Ø11.8\*Ø14.8/M14\*1.5)



**RE1511**  
Link Stabilizer  
L=384



**RE2115**  
Lower Control Arm Bush



**RE1918**  
Lower Ball Joint  
(Ø14.5)



**RE1918**  
Lower Ball Joint  
(Ø14.5)



**RE2034**  
Lower Control Arm



**RE2035**  
Lower Control Arm

**RE2122**  
Lower Control Arm Bush



**RE2820**  
Shock Mounting



**RE2821**  
Shock Mounting



LEFT

RIGHT

**RENAULT**

LAGUNA

FRONT

ALL MODELS

Year

2002-2007

**NI1335**  
Outer Tie Rod End Set  
(Ø12\*Ø14.6/M14\*1.5)



**NI1041**  
Outer Tie Rod End  
(Ø12\*Ø14.6/M14\*1.5)



**RE1426**  
Rack End  
(12\*1.0/14\*1.5/218)



**NI1042**  
Outer Tie Rod End  
(Ø12\*Ø14.6/M14\*1.5)



**NI1536**  
Link Stabilizer  
L=279



**NI2123**  
Lower Control Arm Bush



**NI1921**  
Lower Ball Joint  
(Ø17.84)



**NI1921**  
Lower Ball Joint  
(Ø17.84)



**RE2024**  
Lower Control Arm

**RE2025**  
Lower Control Arm

**RE2117**  
Lower Control Arm Bush

**RE2820**  
Shock Mounting



**RE2813**  
Stabilizer Bar Bush



**RE2821**  
Shock Mounting



LAGUNA

REAR

**RE2911**  
Bush



**RE2912**  
Bush



LEFT

RIGHT

**RENAULT**

LAGUNA

FRONT

ALL MODELS

Year

2009-

**RE1322**  
Outer Tie Rod End Set  
(Ø13.9\*Ø18.9/M14\*1.5)



**RE1031**  
Outer Tie Rod End  
(Ø13.9\*Ø18.9/M14\*1.5)



**RE1427**  
Rack End  
(14\*1.5/14\*1.5/188)



**RE1032**  
Outer Tie Rod End  
(Ø13.9\*Ø18.9/M14\*1.5)



**RE1516**  
Link Stabilizer  
L=294



**RE2123**  
Lower Control Arm Bush



**RE1919**  
Lower Ball Joint  
(Ø15.9)



**RE1919**  
Lower Ball Joint  
(Ø15.9)



**RE2036**  
Lower Control Arm



**RE2037**  
Lower Control Arm



LEFT

RIGHT

**RENAULT**

LOGAN

FRONT

ALL MODELS

Year

2009-

**NI1036**  
Outer Tie Rod End  
(Ø12\*Ø14.5/M14\*1.5)



**NI1330**  
Outer Tie Rod End Set  
(Ø12\*Ø14.5/M14\*1.5)

**NI1423**  
Rack End  
(12\*1.0/14\*1.5/194)



**NI1037**  
Outer Tie Rod End  
(Ø12\*Ø14.5/M14\*1.5)



**MN1411**  
Rack End  
(14\*1.5/14\*1.5/196)



**NI1931**  
Lower Ball Joint  
(Ø18)



**NI1931**  
Lower Ball Joint  
(Ø18)

**NI2038**  
Lower Control Arm

**NI2039**  
Lower Control Arm

**NI2121**  
Lower Control Arm Bush

**NI2821**  
Shock Mounting



**NI2821**  
Shock Mounting



LEFT

RIGHT



**RENAULT**

MEGANE.SCENIC FRONT

Year

1997-2003



**RE1312**  
Outer Tie Rod End Set  
(Ø11.9\*Ø14.5/M14\*1.5)

**RE1013**  
Outer Tie Rod End  
(Ø11.9\*Ø14.5/M14\*1.5)

**RE1428**  
Rack End  
(14\*1.5/14\*1.5/256)

**RE1014**  
Outer Tie Rod End  
(Ø11.9\*Ø14.5/M14\*1.5)

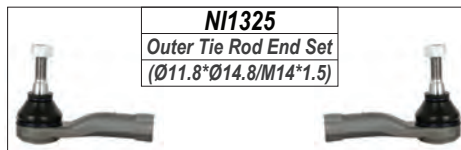

**NI1325**  
Outer Tie Rod End Set  
(Ø11.8\*Ø14.8/M14\*1.5)

**NI1018**  
Outer Tie Rod End  
(Ø11.8\*Ø14.8/M14\*1.5)

**RE1417**  
Rack End  
(12\*1.0/14\*1.5/260)

**NI1030**  
Outer Tie Rod End  
(Ø11.8\*Ø14.8/M14\*1.5)



**RE1429**  
Rack End  
(12\*1.0/14\*1.5/292)



**RE1517**  
Link Stabilizer  
L=257



**RE2124**  
Lower Control Arm Bush



**RE1910**  
Lower Ball Joint  
(Ø16)(10.5mm Hole)



**RE1910**  
Lower Ball Joint  
(Ø16)(10.5mm Hole)



**RE2038**  
Lower Control Arm

**RE2039**  
Lower Control Arm

LEFT

RIGHT

**RENAULT**

MEGANE.SCENIC FRONT

Year

1997-2003



LEFT

RIGHT

**RENAULT**

MEGANE.SCENIC FRONT

Year

2004-2009

II

**RE1316**  
Outer Tie Rod End Set  
(Ø11.8\*Ø14.8/M14\*1.5)



**RE1021**  
Outer Tie Rod End  
(Ø11.8\*Ø14.8/M14\*1.5)



**RE1420**  
Rack End  
(14\*1.5/14\*1.5/217)



**RE1022**  
Outer Tie Rod End  
(Ø11.8\*Ø14.8/M14\*1.5)



**RE1513**  
Link Stabilizer  
L=266



**RE1514**  
Link Stabilizer  
L=283



**RE2111**  
Lower Control Arm Bush



**NI1931**  
Lower Ball Joint  
(Ø18)



**NI1931**  
Lower Ball Joint  
(Ø18)



**RE2012**  
Lower Control Arm



**RE2013**  
Lower Control Arm



**NI2122**  
Lower Control Arm Bush

**RE2111**  
Lower Control Arm Bush



**RE1915**  
Lower Ball Joint  
(Ø16)



**RE1915**  
Lower Ball Joint  
(Ø16)



**RE2028**  
Lower Control Arm



**RE2029**  
Lower Control Arm



**RE2817**  
Shock Mounting



**RE2817**  
Shock Mounting



**NI2122**  
Lower Control Arm Bush

LEFT

RIGHT

**RENAULT**

MEGANE.SCENIC FRONT

Year

2010-2015

III

**RE1317**  
Outer Tie Rod End Set  
(Ø11.85\*Ø14.7/M14\*1.5)



**RE1023**  
Outer Tie Rod End  
(Ø11.85\*Ø14.7/M14\*1.5)



**RE1419**  
Rack End  
(14\*1.5/14\*1.5/209)



**RE1024**  
Outer Tie Rod End  
(Ø11.85\*Ø14.7/M14\*1.5)



**RE1515**  
Link Stabilizer  
L=274



**RE2119**  
Lower Control Arm Bush



**RE2026**  
Lower Control Arm

**RE2027**  
Lower Control Arm

**RE1914**  
Lower Ball Joint  
(Ø17.2)



**RE1914**  
Lower Ball Joint  
(Ø17.2)



**RE2118**  
Lower Control Arm Bush



**RE2119**  
Lower Control Arm Bush



**RE2030**  
Lower Control Arm



**RE2031**  
Lower Control Arm



**RE2818**  
Shock Mounting



**RE2130**  
Lower Control Arm Bush



**RE2818**  
Shock Mounting



LEFT

RIGHT

**RENAULT**

MEGANE

FRONT

IV

Year

2015-

**RE1323**  
Outer Tie Rod End Set  
(Ø11.8\*Ø14.9/M14\*1.5)

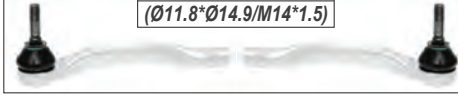

**RE1033**  
Outer Tie Rod End  
(Ø11.8\*Ø14.9/M14\*1.5)



**RE1430**  
Rack End  
(14\*1.5/14\*1.5/209)



**RE1034**  
Outer Tie Rod End  
(Ø11.8\*Ø14.9/M14\*1.5)



**RE1518**  
Link Stabilizer  
L=273.5



**RE2126**  
Lower Control Arm Bush



**RE1921**  
Lower Ball Joint  
(Ø18)



**RE1921**  
Lower Ball Joint  
(Ø18)



**RE2044**  
Lower Control Arm



**RE2045**  
Lower Control Arm



**RE2127**  
Lower Control Arm Bush



LEFT

RIGHT



**RENAULT**

MODUS

FRONT

ALL MODELS

Year

2005-2009

**NI1018**  
Outer Tie Rod End  
(Ø11.8\*Ø14.8/M14\*1.5)

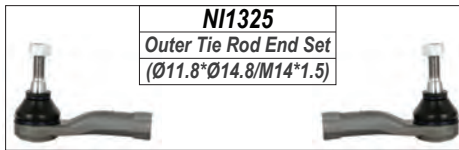

**NI1325**  
Outer Tie Rod End Set  
(Ø11.8\*Ø14.8/M14\*1.5)

**NI1419**  
Rack End  
(14\*1.5/14\*1.5/308)

**NI1030**  
Outer Tie Rod End  
(Ø11.8\*Ø14.8/M14\*1.5)



**NI1522**  
Link Stabilizer  
L=248



**NI2117**  
Lower Control Arm Bush



**NI1931**  
Lower Ball Joint  
(Ø18)



**NI1931**  
Lower Ball Joint  
(Ø18)



**NI2040**  
Lower Control Arm



**NI2041**  
Lower Control Arm



**NI2118**  
Lower Control Arm Bush



**NI2814**  
Shock Mounting



**NI2815**  
Shock Mounting



LEFT

RIGHT

**RENAULT**

**SANDERO**

**FRONT**

**ALL MODELS**

*Year*

**2009-**

**NI1036**  
Outer Tie Rod End  
(Ø12\*Ø14.5/M14\*1.5)



**NI1330**  
Outer Tie Rod End Set  
(Ø12\*Ø14.5/M14\*1.5)

**NI1423**  
Rack End  
(12\*1.0/14\*1.5/194)



**NI1037**  
Outer Tie Rod End  
(Ø12\*Ø14.5/M14\*1.5)



**MN1411**  
Rack End  
(14\*1.5/14\*1.5/196)



**NI1931**  
Lower Ball Joint  
(Ø18)



**NI1931**  
Lower Ball Joint  
(Ø18)



**NI2121**  
Lower Control Arm Bush



**NI2038**  
Lower Control Arm

**NI2039**  
Lower Control Arm

**RE2910**  
Bush



**NI2821**  
Shock Mounting



**RE2712**  
Repair Kit



**NI2821**  
Shock Mounting



**LEFT**

**RIGHT**

**RENAULT**

TRAFIC

FRONT

ALL MODELS

Year

2005-2008

**NI1335**  
Outer Tie Rod End Set  
(Ø12\*Ø14.6/M14\*1.5)



**NI1041**  
Outer Tie Rod End  
(Ø12\*Ø14.6/M14\*1.5)



**RE1426**  
Rack End  
(12\*1.0/14\*1.5/263)



**NI1042**  
Outer Tie Rod End  
(Ø12\*Ø14.6/M14\*1.5)



**NI1536**  
Link Stabilizer  
L=279



**NI1921**  
Lower Ball Joint  
(Ø17.84)



**NI2123**  
Lower Control Arm Bush



**NI1921**  
Lower Ball Joint  
(Ø17.84)



**NI2044**  
Lower Control Arm

**NI2045**  
Lower Control Arm

**RE2117**  
Lower Control Arm Bush

**NI2123**  
Lower Control Arm Bush

**OP1919**  
Lower Ball Joint  
(Ø17.84)



**OP1919**  
Lower Ball Joint  
(Ø17.84)



**OP2030**  
Lower Control Arm

**OP2031**  
Lower Control Arm

**NI2824**  
Shock Mounting



**OP2122**  
Lower Control Arm Bush

**NI2824**  
Shock Mounting



LEFT

RIGHT

**ROVER**

75 SERIES

FRONT

ALL MODELS

Year

1999-

**RO1010**  
Outer Tie Rod End

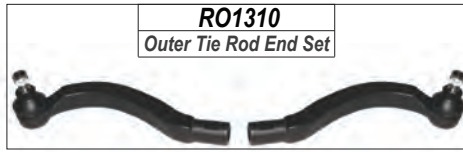

**RO1011**  
Outer Tie Rod End



**RO1510**  
Link Stabilizer  
L=285



**AU1515 / AU1516**  
Link Stabilizer  
L=340

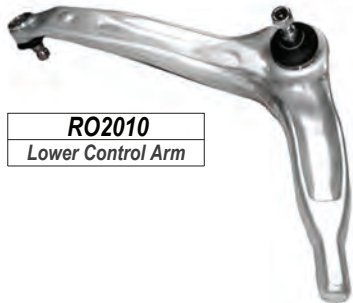

**RO2010**  
Lower Control Arm



**RO2011**  
Lower Control Arm



**RO2110 / RO2111**  
Lower Control Bush

75 SERIES

REAR

**RO1511 / RO1512**  
Link Stabilizer  
L=105



LEFT

RIGHT

**SAAB**

9-3

FRONT

ALL MODELS

Year

1998-2003

**OP1016**  
Outer Tie Rod End  
(Ø13\*Ø15.5/M16\*2)

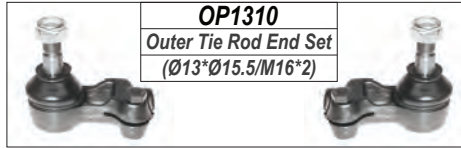

**OP1310**  
Outer Tie Rod End Set  
(Ø13\*Ø15.5/M16\*2)

**OP1423**  
Rack End  
(16\*2.0/16\*2.0/100)



**OP1017**  
Outer Tie Rod End  
(Ø13\*Ø15.5/M16\*2)



**OP1424 / OP1425**  
Rack End



**OP1513**  
Link Stabilizer  
L=85



**SA2010**  
Lower Control Arm



**SA2011**  
Lower Control Arm

**SA2910**  
Bush



LEFT

RIGHT



**SAAB**

9-3

FRONT

ALL MODELS

Year

2003-2012

**SA1010**  
Outer Tie Rod End  
(Ø12.3\*Ø17/M14\*1.5)

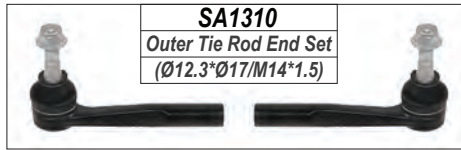

**SA1310**  
Outer Tie Rod End Set  
(Ø12.3\*Ø17/M14\*1.5)

**SA1011**  
Outer Tie Rod End  
(Ø12.3\*Ø17/M14\*1.5)



**SA1410**  
Rack End  
(14\*1.5/14\*1.5/295)



**SA1510**  
Link Stabilizer  
L=352.5



**OP2114**  
Lower Control Arm Bush



**SA2012**  
Lower Control Arm

**SA2013**  
Lower Control Arm

**SA2110**  
Lower Control Arm Bush

**SA2810**  
Stabilizer Bar Bush  
ID:24 OD:42.5



**SA2811**  
Stabilizer Bar Bush  
ID:22 OD:43



LEFT

RIGHT

**SAAB**

9-3

REAR

ALL MODELS

Year

2003-2012

<b>SA1511</b>
Link Stabilizer
L=86



<b>SA2610</b>
Lateral Link



<b>SA2610</b>
Lateral Link

<b>SA2812</b>
Stabilizer Bar Bush
ID:18 OD:38



<b>SA2813</b>
Stabilizer Bar Bush
ID:17 OD:38



<b>SA2814</b>
Stabilizer Bar Bush
ID:19 OD:38



<b>SA2911</b>
Stabilizer Bar Bush
ID:12 OD:45.5



<b>SA2912</b>
Stabilizer Bar Bush
ID:12.8 OD:70.3



**LEFT**

**RIGHT**

**SAAB**

9-5

**FRONT**

**ALL MODELS**

Year

1998-2010

**SA1012**  
Outer Tie Rod End  
(Ø13.4\*Ø16.4/M14\*1.5)

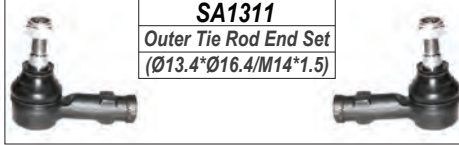

**SA1311**  
Outer Tie Rod End Set  
(Ø13.4\*Ø16.4/M14\*1.5)

**SA1012**  
Outer Tie Rod End  
(Ø13.4\*Ø16.4/M14\*1.5)



**SA1411**  
Rack End  
(16\*1.5/14\*1.5/345)



**SA1010**  
Outer Tie Rod End  
(Ø12.3\*Ø17/M14\*1.5)

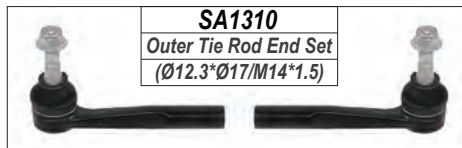

**SA1310**  
Outer Tie Rod End Set  
(Ø12.3\*Ø17/M14\*1.5)

**SA1011**  
Outer Tie Rod End  
(Ø12.3\*Ø17/M14\*1.5)



**SA1412**  
Rack End  
(16\*1.5/14\*1.5/283)



**OP1520**  
Link Stabilizer  
L=243



**SA1910**  
Lower Ball Joint  
(Ø20)



**SA1910**  
Lower Ball Joint  
(Ø20)



**OP1915**  
Lower Ball Joint  
(Ø18)



**OP1915**  
Lower Ball Joint  
(Ø18)



9-5

**REAR**

**SA2913**  
Bush



**SA2611**  
Lateral Link  
L=525



**SA2611**  
Lateral Link  
L=525



**SA2914**  
Bush



**LEFT**

**RIGHT**

**SAAB**

900

FRONT

ALL MODELS

Year

1995-1998

**OP1016**  
Outer Tie Rod End  
(Ø13\*Ø15.5/M16\*2)

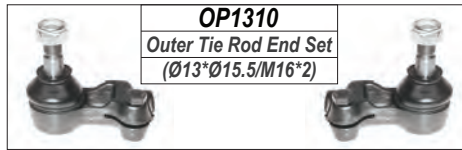

**OP1310**  
Outer Tie Rod End Set  
(Ø13\*Ø15.5/M16\*2)

**OP1423**  
Rack End  
(16\*2.0/16\*2.0/100)



**OP1017**  
Outer Tie Rod End  
(Ø13\*Ø15.5/M16\*2)



**OP1424 / OP1425**  
Rack End



**OP1511**  
Link Stabilizer  
L=79.5



**OP1513**  
Link Stabilizer  
L=85



**SA1512**  
Link Stabilizer  
L=89.5



**SA2010**  
Lower Control Arm

**SA2011**  
Lower Control Arm

**SA2910**  
Bush



**LEFT**

**RIGHT**

**SAAB**

9000

FRONT

Year

ALL MODELS

1989-1998

**SA1013**  
Outer Tie Rod End  
(Ø12.92\*Ø14.8/M14\*1.5)

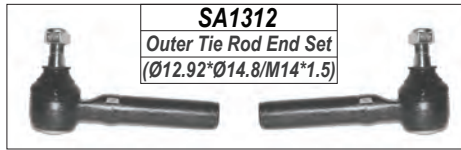

**SA1312**  
Outer Tie Rod End Set  
(Ø12.92\*Ø14.8/M14\*1.5)

**SA1413**  
Rack End  
(14\*1.5/14\*1.5/296)

**SA1013**  
Outer Tie Rod End  
(Ø12.92\*Ø14.8/M14\*1.5)



**AF1520**  
Link Stabilizer  
L=106



**SA1513**  
Link Stabilizer  
L=112.5



**SA1911**  
Lower Ball Joint  
(Ø20)



**SA2014**  
Lower Control Arm



**SA2015**  
Lower Control Arm



**SA1911**  
Lower Ball Joint  
(Ø20)



LEFT

RIGHT



**SEAT**

**ALTEA**

**FRONT**

**ALL MODELS**

**Year**

**2004-2011**

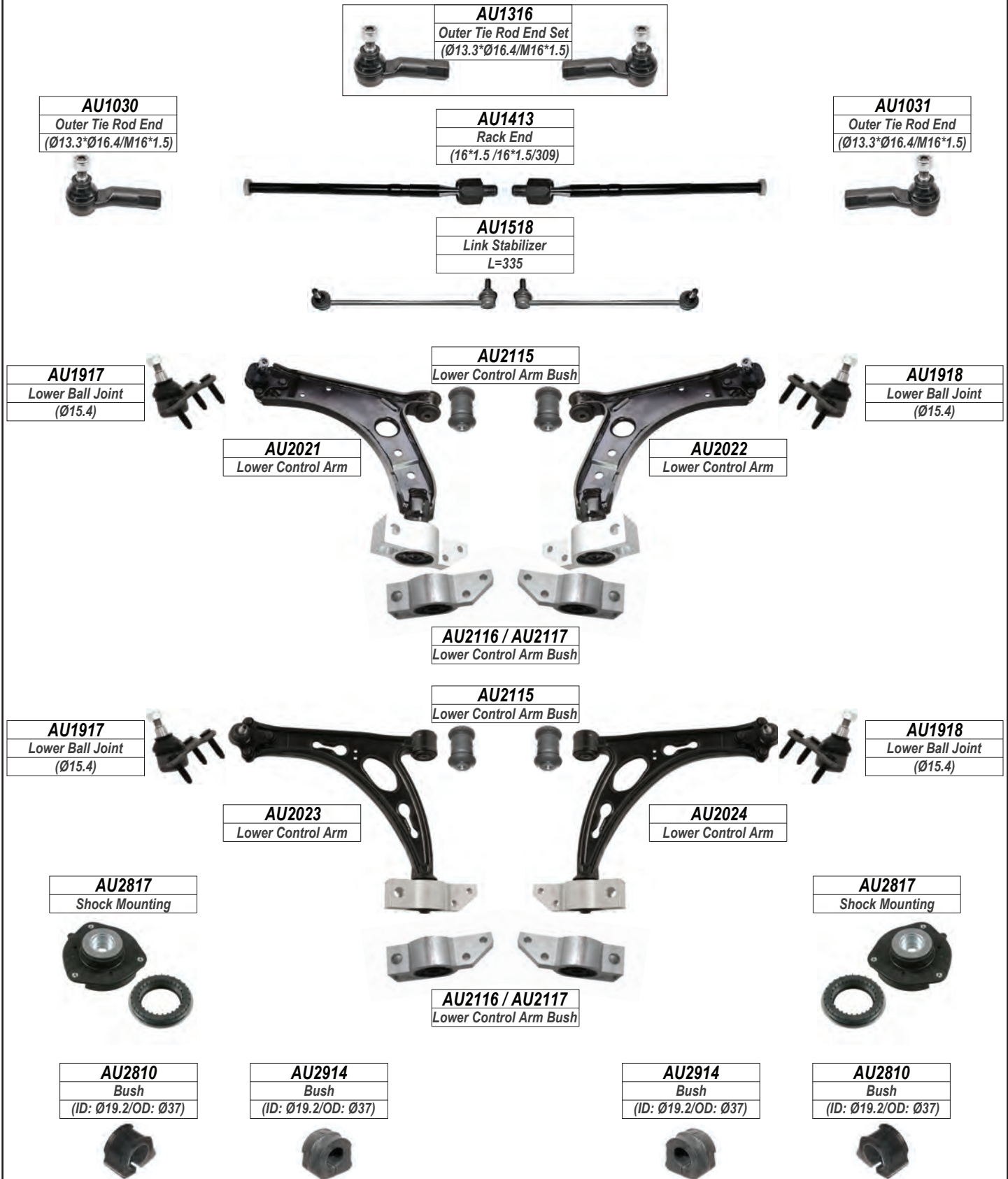

**LEFT**

**RIGHT**

**SEAT**

**ALTEA**

**REAR**

**ALL MODELS**

*Year*

**2004-2011**

**AU1519**  
Link Stabilizer  
L=95.5



**AU2915**  
Bush  
(ID: Ø14.3/OD: Ø24.3)



**VW2911**  
Bush

**VW2911**  
Bush



**AU2610**  
Lateral Link

**AU2610**  
Lateral Link

**AU1710**  
Upper Control Arm



**AU2080 / AU2081**  
Lower Control Arm



**VW2114**  
Lower Control Arm Bush



**VW2014**  
Lower Control Arm

**VW2014**  
Lower Control Arm



**AU2818**  
Shock Mounting



**AU2818**  
Shock Mounting



**LEFT**

**RIGHT**

**SEAT**

IBIZA

FRONT

IV

Year

2006-2008

**SE1010**  
Outer Tie Rod End  
(Ø12.7\*Ø14.7/M14\*1.5)

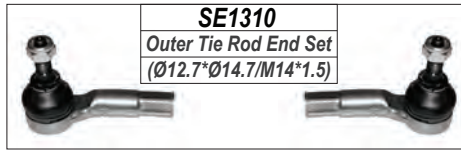

**SE1310**  
Outer Tie Rod End Set  
(Ø12.7\*Ø14.7/M14\*1.5)

**VW1424**  
Rack End  
(14\*1.5/14\*1.5/297)



**SE1011**  
Outer Tie Rod End  
(Ø12.7\*Ø14.7/M14\*1.5)



**AU1511**  
Link Stabilizer  
L=271



**SE2110**  
Lower Control Arm Bush

**SE1910**  
Lower Ball Joint  
(Ø14.9)



**SE2010**  
Lower Control Arm

**SE2010**  
Lower Control Arm

**SE1911**  
Lower Ball Joint  
(Ø14.9)



**SE2111**  
Lower Control Arm Bush

IBIZA

REAR

**AU2912**  
Bush  
(ID: Ø12.2/OD: Ø71.5)



**AU2815**  
Shock Mounting



**AU2815**  
Shock Mounting



LEFT

RIGHT

**SEAT**

IBIZA

FRONT

Year

2008-

V

**AU1315**  
Outer Tie Rod End Set  
(Ø13.2\*Ø17.2/M14\*1.5)

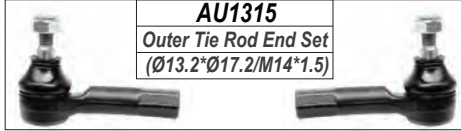

**AU1020**  
Outer Tie Rod End  
(Ø13.2\*Ø17.2/M14\*1.5)



**SE1412**  
Rack End  
(14\*1.5 /14\*1.5/294)



**AU1021**  
Outer Tie Rod End  
(Ø13.2\*Ø17.2/M14\*1.5)



**AU1313**  
Outer Tie Rod End Set  
(Ø13.2\*Ø17.2/M14\*1.5)



**AU1016**  
Outer Tie Rod End  
(Ø13.2\*Ø17.2/M14\*1.5)



**AU1410**  
Rack End  
(14\*1.5 /14\*1.5/310)



**AU1017**  
Outer Tie Rod End  
(Ø13.2\*Ø17.2/M14\*1.5)



**AU1511**  
Link Stabilizer  
L=271

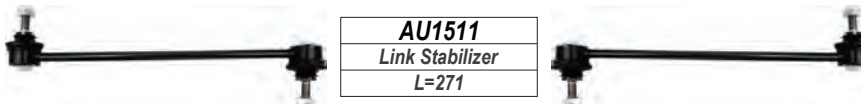

**VW2040**  
Lower Control Arm



**AU2113**  
Lower Control Arm Bush



**VW2041**  
Lower Control Arm



**AU2114**  
Lower Control Arm Bush



**AU1913**  
Lower Ball Joint  
(Ø14.9)



**AU1914**  
Lower Ball Joint  
(Ø14.9)



**AU2016**  
Lower Control Arm



**AU2113**  
Lower Control Arm Bush



**AU2017**  
Lower Control Arm



**AU2114**  
Lower Control Arm Bush



**AU2814**  
Shock Mounting



**AU2814**  
Shock Mounting



IBIZA

REAR

**AU2815**  
Shock Mounting



**AU2912**  
Bush  
(ID: Ø12.2/OD: Ø71.5)



**AU2815**  
Shock Mounting



LEFT

RIGHT



**SEAT**

**LEON**

**FRONT**

**ALL MODELS**

**Year**

**2005-2012**

**AU1316**  
Outer Tie Rod End Set  
(Ø13.3\*Ø16.4/M16\*1.5)

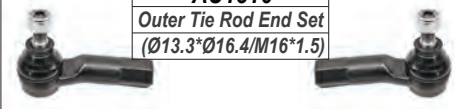

**AU1030**  
Outer Tie Rod End  
(Ø13.3\*Ø16.4/M16\*1.5)



**AU1413**  
Rack End  
(16\*1.5 /16\*1.5/309)



**AU1031**  
Outer Tie Rod End  
(Ø13.3\*Ø16.4/M16\*1.5)



**AU1518**  
Link Stabilizer  
L=335



**AU2115**  
Lower Control Arm Bush



**AU1917**  
Lower Ball Joint  
(Ø15.4)



**AU1918**  
Lower Ball Joint  
(Ø15.4)



**AU2021**  
Lower Control Arm



**AU2022**  
Lower Control Arm



**AU2116 / AU2117**  
Lower Control Arm Bush



**AU2115**  
Lower Control Arm Bush



**AU1917**  
Lower Ball Joint  
(Ø15.4)



**AU1918**  
Lower Ball Joint  
(Ø15.4)



**AU2023**  
Lower Control Arm



**AU2024**  
Lower Control Arm



**AU2817**  
Shock Mounting



**AU2817**  
Shock Mounting



**AU2116 / AU2117**  
Lower Control Arm Bush



**AU2810**  
Bush  
(ID: Ø19.2/OD: Ø37)



**AU2914**  
Bush  
(ID: Ø19.2/OD: Ø37)



**AU2914**  
Bush  
(ID: Ø19.2/OD: Ø37)



**AU2810**  
Bush  
(ID: Ø19.2/OD: Ø37)



**LEFT**

**RIGHT**



**SEAT**

**LEON**

**REAR**

**ALL MODELS**

*Year*

**2005-2012**

**AU1519**  
Link Stabilizer  
L=95.5



**AU2915**  
Bush  
(ID: Ø14.3/OD: Ø24.3)



**VW2911**  
Bush



**VW2911**  
Bush

**AU2610**  
Lateral Link

**AU2610**  
Lateral Link



**AU1710**  
Upper Control Arm



**AU2080 / AU2081**  
Lower Control Arm

**VW2114**  
Lower Control Arm Bush



**VW2014**  
Lower Control Arm

**VW2014**  
Lower Control Arm

**AU2818**  
Shock Mounting



**AU2818**  
Shock Mounting



**LEFT**

**RIGHT**

**SMART**

**CABRIO. COUPE. FRONT**  
**ROADSTAR.FORTWO**

Year

**ALL MODELS**

**2000-2006**

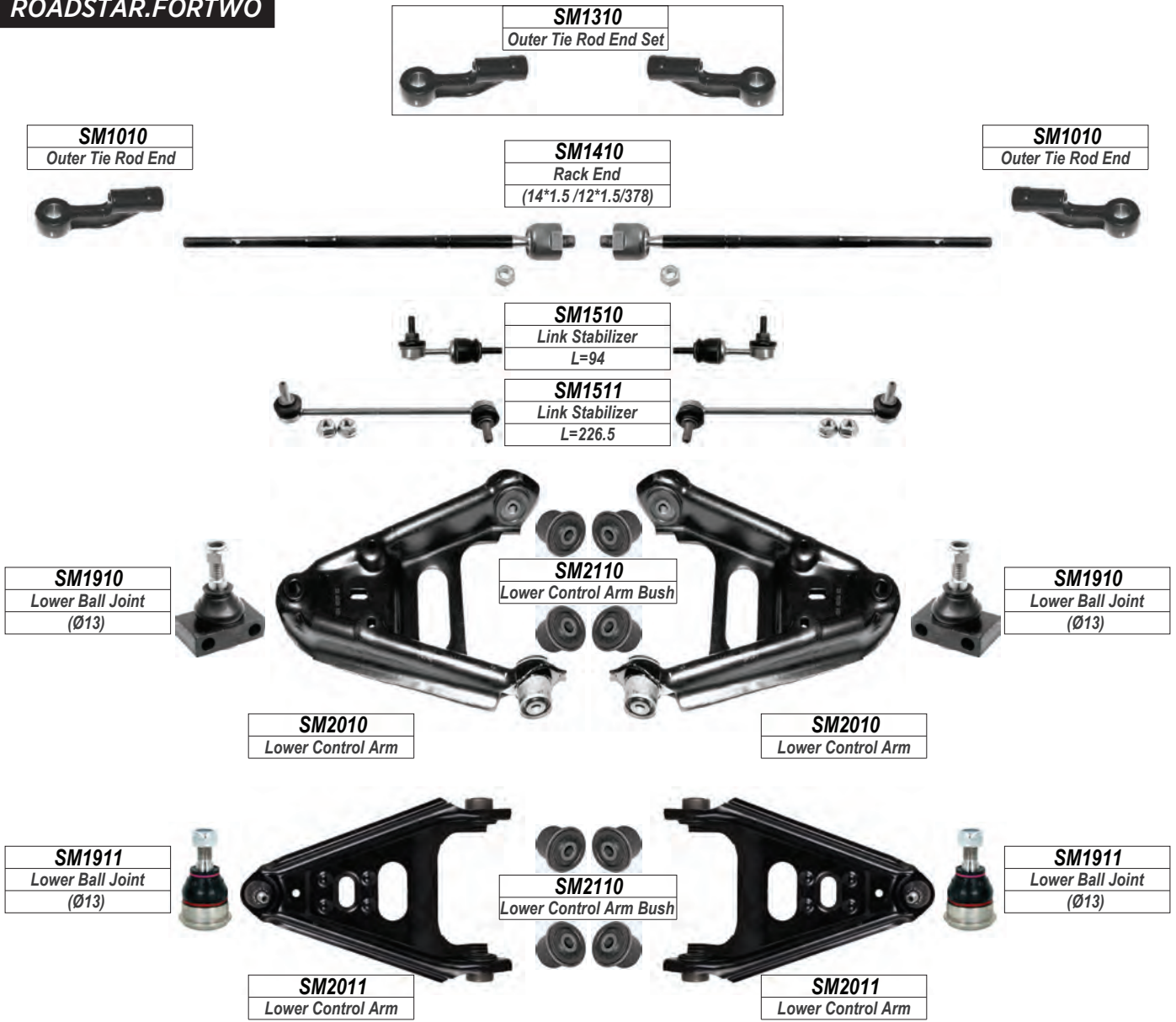

**CABRIO. COUPE. REAR**  
**ROADSTAR.FORTWO**



**LEFT**

**RIGHT**

**SMART**

**FORFOUR**

**FRONT**

**ALL MODELS**

*Year*

**2004-2006**

**SM1311**

Outer Tie Rod End Set  
(Ø12.3\*Ø15.5/M12\*1.25)

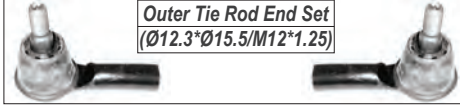

**SM1011**

Outer Tie Rod End  
(Ø12.3\*Ø15.5/M12\*1.25)



**SM1011**

Outer Tie Rod End  
(Ø12.3\*Ø15.5/M12\*1.25)



**SM1513**

Link Stabilizer  
L=324



**CI2121**

Lower Control Arm Bush

**SM1912**

Lower Ball Joint  
(Ø14.5)



**SM1912**

Lower Ball Joint  
(Ø14.5)



**SM2012**

Lower Control Arm

**SM2013**

Lower Control Arm

**CI2120**

Lower Control Arm Bush



**LEFT**

**RIGHT**

**SSANGYONG**

ACTYON

FRONT

ALL MODELS

Year

2005-

**SS1310**  
Outer Tie Rod End Set  
(Ø16\*Ø18.1/M16\*1.5)



**SS1010**  
Outer Tie Rod End  
(Ø16\*Ø18.1/M16\*1.5)



**SS1011**  
Outer Tie Rod End  
(Ø16\*Ø18.1/M16\*1.5)



**SS1510**  
Link Stabilizer  
L=171



**SS1511 / SS1512**  
Link Stabilizer  
L=205



**SS1610**  
Upper Ball Joint  
(Ø17.6)



**SS1610**  
Upper Ball Joint  
(Ø17.6)



**SS1810**  
Upper Control Arm Bush



**SS1710**  
Upper Control Arm

**SS1711**  
Upper Control Arm

**SS1910**  
Lower Ball Joint  
(Ø17.25)



**SS1910**  
Lower Ball Joint  
(Ø17.25)



**SS2010**  
Lower Control Arm  
4 WD



**SS2011**  
Lower Control Arm  
4 WD



LEFT

RIGHT

**SSANGYONG**

**KORANDO.MUSSO FRONT**

**ALL MODELS**

*Year*

**1996-2005**

**SS1311**  
Outer Tie Rod End Set  
(Ø16\*Ø18.1/M14\*1.5)



**SS1312**  
Outer Tie Rod End Set  
(Ø15.3\*Ø13.63/M14\*1.5)

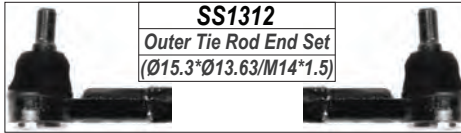

**FI1418**  
Rack End  
(16\*1.5/14\*1.5/283)



**SS1012**  
Outer Tie Rod End  
(Ø16\*Ø18.1/M14\*1.5)



**SS1012**  
Outer Tie Rod End  
(Ø16\*Ø18.1/M14\*1.5)



**SS1013**  
Outer Tie Rod End  
(Ø15.3\*Ø13.63/M14\*1.5)



**SS1013**  
Outer Tie Rod End  
(Ø15.3\*Ø13.63/M14\*1.5)



**SS1510**  
Link Stabilizer  
L=171



**IS1610**  
Upper Ball Joint  
(Ø17.6)



**IS1610**  
Upper Ball Joint  
(Ø17.6)



**SS1911**  
Lower Ball Joint  
(Ø17.55)



**SS1911**  
Lower Ball Joint  
(Ø17.55)



**LEFT**

**RIGHT**



**SSANGYONG**

**KYRON.REXTON FRONT**

**ALL MODELS**

Year

**2005-**

**SS1310**  
Outer Tie Rod End Set  
( $\varnothing 16 \times \varnothing 18.1 / M16 \times 1.5$ )



**SS1010**  
Outer Tie Rod End  
( $\varnothing 16 \times \varnothing 18.1 / M16 \times 1.5$ )



**SS1410**  
Rack End  
( $16 \times 1.5 / 14 \times 1.5 / 283$ )



**SS1011**  
Outer Tie Rod End  
( $\varnothing 16 \times \varnothing 18.1 / M16 \times 1.5$ )



**SS1511 / SS1512**  
Link Stabilizer  
L=205



**SS1610**  
Upper Ball Joint  
( $\varnothing 17.6$ )



**SS1810**  
Upper Control Arm Bush

**SS1610**  
Upper Ball Joint  
( $\varnothing 17.6$ )



**SS1710**  
Upper Control Arm

**SS1711**  
Upper Control Arm

**SS1910**  
Lower Ball Joint  
( $\varnothing 17.25$ )



**SS1910**  
Lower Ball Joint  
( $\varnothing 17.25$ )



**KYRON.REXTON REAR**

**SS1513 / SS1514**  
Link Stabilizer  
L=205



**LEFT**

**RIGHT**

**SUBARU**

**FORESTER**

**FRONT**

**SF**

*Year*

**1996-2002**

**SU1310**  
Outer Tie Rod End Set  
(Ø12.9\*Ø15.4/M14\*1.5)

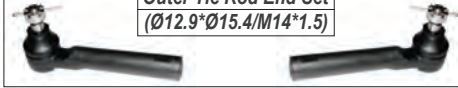

**SU1010**  
Outer Tie Rod End  
(Ø12.9\*Ø15.4/M14\*1.5)



**SU1410**  
Rack End  
(14\*1.5 /14\*1.5/309)



**SU1010**  
Outer Tie Rod End  
(Ø12.9\*Ø15.4/M14\*1.5)



**SU2112**  
Lower Control Arm Bush



**SU1910**  
Lower Ball Joint  
(Ø15.45)



**SU2010**  
Lower Control Arm

**SU2011**  
Lower Control Arm

**SU1910**  
Lower Ball Joint  
(Ø15.45)



**SU2113 / SU2114**  
Lower Control Arm Bush



**LEFT**

**RIGHT**

**SUBARU**

**FORESTER.OUTBACK FRONT**

Year

SG

2003-2008

**SU1310**  
Outer Tie Rod End Set  
(Ø12.9\*Ø15.4/M14\*1.5)

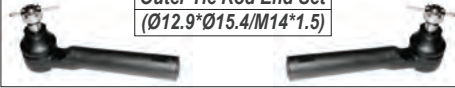

**SU1010**  
Outer Tie Rod End  
(Ø12.9\*Ø15.4/M14\*1.5)



**SU1411**  
Rack End  
(16\*1.5 / 14\*1.5/302)



**SU1010**  
Outer Tie Rod End  
(Ø12.9\*Ø15.4/M14\*1.5)



**SU1510**  
Link Stabilizer  
L=60



**SU2115**  
Lower Control Arm Bush



**SU1910**  
Lower Ball Joint  
(Ø15.45)



**SU1910**  
Lower Ball Joint  
(Ø15.45)



**SU2012**  
Lower Control Arm



**SU2013**  
Lower Control Arm



**SU2116 / SU2117**  
Lower Control Arm Bush



**FORESTER.OUTBACK REAR**

**SU1511**  
Link Stabilizer  
L=70.5



**LEFT**

**RIGHT**

**SUBARU**

**FORESTER.OUTBACK FRONT**

Year

2008-2013

SH

**SU1310**  
Outer Tie Rod End Set  
(Ø12.9\*Ø15.4/M14\*1.5)

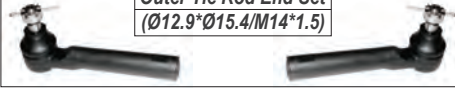

**SU1010**  
Outer Tie Rod End  
(Ø12.9\*Ø15.4/M14\*1.5)



**SU1412**  
Rack End  
(16\*1.5 /14\*1.5/324)



**SU1010**  
Outer Tie Rod End  
(Ø12.9\*Ø15.4/M14\*1.5)



**SU1510**  
Link Stabilizer  
L=60



**SU2118**  
Lower Control Arm Bush



**SU1910**  
Lower Ball Joint  
(Ø15.45)



**SU1910**  
Lower Ball Joint  
(Ø15.45)

**SU2014**  
Lower Control Arm

**SU2015**  
Lower Control Arm

**SU2119**  
Lower Control Arm Bush



**FORESTER.OUTBACK REAR**

**SU1511**  
Link Stabilizer  
L=70.5



**LEFT**

**RIGHT**

**SUBARU**

IMPREZA.LEGACY

FRONT

GC

Year

1995-2001

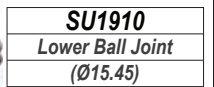
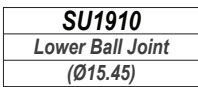
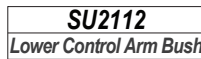
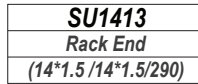
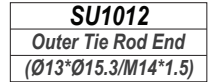
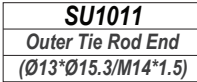
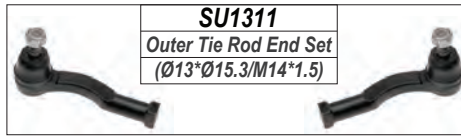

**LEFT**

**RIGHT**



**SUBARU**

IMPREZA.LEGACY FRONT

GD

Year

2000-2007

**SU1310**  
Outer Tie Rod End Set  
(Ø12.9\*Ø15.4/M14\*1.5)

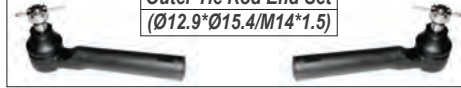

**SU1010**  
Outer Tie Rod End  
(Ø12.9\*Ø15.4/M14\*1.5)

**SU1413**  
Rack End  
(14\*1.5/14\*1.5/290)

**SU1010**  
Outer Tie Rod End  
(Ø12.9\*Ø15.4/M14\*1.5)

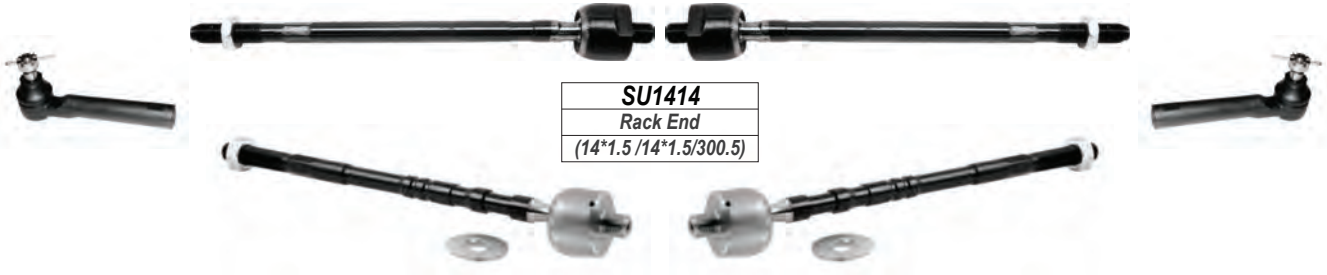

**SU1414**  
Rack End  
(14\*1.5/14\*1.5/300.5)

**SU1510**  
Link Stabilizer  
L=60



**SU2112**  
Lower Control Arm Bush

**SU1910**  
Lower Ball Joint  
(Ø15.45)



**SU2010**  
Lower Control Arm

**SU2011**  
Lower Control Arm

**SU1910**  
Lower Ball Joint  
(Ø15.45)



**SU2113 / SU2114**  
Lower Control Arm Bush

IMPREZA.LEGACY REAR

**SU1511**  
Link Stabilizer  
L=70.5



LEFT

RIGHT

**SUBARU**

**IMPREZA**

**FRONT**

**GR**

Year

2007-2014

**SU1310**  
Outer Tie Rod End Set  
(Ø12.9\*Ø15.4/M14\*1.5)

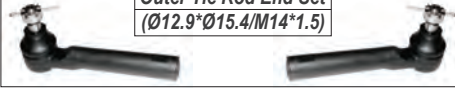

**SU1010**  
Outer Tie Rod End  
(Ø12.9\*Ø15.4/M14\*1.5)



**SU1010**  
Outer Tie Rod End  
(Ø12.9\*Ø15.4/M14\*1.5)



**SU1414**  
Rack End  
(14\*1.5 /14\*1.5/300.5)



**SU1510**  
Link Stabilizer  
L=60



**SU2118**  
Lower Control Arm Bush

**SU1910**  
Lower Ball Joint  
(Ø15.45)



**SU1910**  
Lower Ball Joint  
(Ø15.45)



**SU2016**  
Lower Control Arm

**SU2017**  
Lower Control Arm

**SU2119**  
Lower Control Arm Bush



**IMPREZA**

**REAR**

**SU1512**  
Link Stabilizer  
L=107.4



**LEFT**

**RIGHT**

**SUZUKI**

ALTO

FRONT

ALL MODELS

Year

2009-

**SZ1310**

Outer Tie Rod End Set  
(Ø13\*Ø15/M12\*1.25)

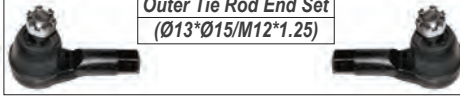

**SZ1010**

Outer Tie Rod End  
(Ø13\*Ø15/M12\*1.25)



**SZ1410**

Rack End  
(14\*1.5/12\*1.25/273)



**SZ1010**

Outer Tie Rod End  
(Ø13\*Ø15/M12\*1.25)



**SZ1510**

Link Stabilizer  
L=282



**SZ2111**

Lower Control Arm Bush



**SZ1910**

Lower Ball Joint  
(Ø13.3)



**SZ1910**

Lower Ball Joint  
(Ø13.3)



**SZ2010**

Lower Control Arm

**SZ2011**

Lower Control Arm

**SZ2110**

Lower Control Arm Bush

**SZ2810**

Shock Mounting



**SZ2810**

Shock Mounting



ALTO

REAR

**SZ2610 / SZ2611**

Lateral Link



LEFT

RIGHT

**SUZUKI**

**BALENO**

**FRONT**

**ALL MODELS**

*Year*

**2015-**

**SZ1319**

Outer Tie Rod End Set  
(Ø12.9\*Ø14.9/M14\*1.5)

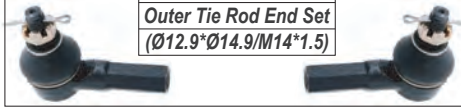

**SZ1021**

Outer Tie Rod End  
(Ø12.9\*Ø14.9/M14\*1.5)



**SZ1417**

Rack End  
(14\*1.5/14\*1.5/323)



**SZ1022**

Outer Tie Rod End  
(Ø12.9\*Ø14.9/M14\*1.5)



**SZ1517**

Link Stabilizer  
L=350



**SZ2114**

Lower Control Arm Bush



**SZ1913**

Lower Ball Joint  
(Ø13.5)



**SZ1913**

Lower Ball Joint  
(Ø13.5)



**SZ2024**

Lower Control Arm

**SZ2025**

Lower Control Arm

**SZ2115**

Lower Control Arm Bush



**LEFT**

**RIGHT**

**SUZUKI**

**ERTIGA**

**FRONT**

**ALL MODELS**

*Year*

**2012-**

**SZ1315**  
Outer Tie Rod End Set  
(Ø13\*Ø15/M14\*1.5)

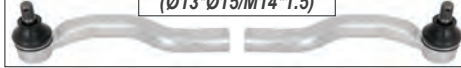

**SZ1018**  
Outer Tie Rod End  
(Ø13\*Ø15/M14\*1.5)



**SZ1416**  
Rack End  
(14\*1.5/14\*1.5/187)



**SZ1019**  
Outer Tie Rod End  
(Ø13\*Ø15/M14\*1.5)



**SZ1516**  
Link Stabilizer  
L=270



**SZ1910**  
Lower Ball Joint  
(Ø13.3)



**SZ1910**  
Lower Ball Joint  
(Ø13.3)



**SZ2018**  
Lower Control Arm



**SZ2019**  
Lower Control Arm



**LEFT**

**RIGHT**



**SUZUKI**

**GRAND VITARA**

**FRONT**

**ALL MODELS**

*Year*

**1999-2008**

**SZ1311**

Outer Tie Rod End Set  
( $\varnothing 12.5 \times \varnothing 14 / M14 \times 1.5$ )

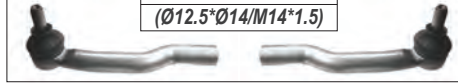

**SZ1011**

Outer Tie Rod End  
( $\varnothing 12.5 \times \varnothing 14 / M14 \times 1.5$ )



**SZ1411**

Rack End  
( $16 \times 1.0 / 14 \times 1.5 / 228$ )



**SZ1012**

Outer Tie Rod End  
( $\varnothing 12.5 \times \varnothing 14 / M14 \times 1.5$ )



**SZ1511**

Link Stabilizer  
L=90



**SZ2112**

Lower Control Arm Bush



**SZ2012**

Lower Control Arm

**SZ2013**

Lower Control Arm

**SZ2113**

Lower Control Arm Bush

**LEFT**

**RIGHT**

**SUZUKI**

**GRAND VITARA**

**FRONT**

**ALL MODELS**

*Year*

**2008-**

**SZ1312**

Outer Tie Rod End Set  
(Ø13\*Ø15/M14\*1.5)

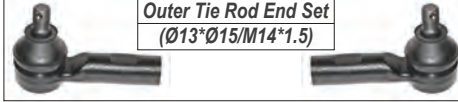

**SZ1013**

Outer Tie Rod End  
(Ø13\*Ø15/M14\*1.5)

**SZ1412**

Rack End  
(18\*1.5 / 14\*1.5/344)

**SZ1013**

Outer Tie Rod End  
(Ø13\*Ø15/M14\*1.5)



**SZ1512**

Link Stabilizer  
L=300.5



**SZ2014**

Lower Control Arm

**SZ2015**

Lower Control Arm

**LEFT**

**RIGHT**

**SUZUKI**

**JIMNY**

**FRONT**

**ALL MODELS**

*Year*

**1998-**

**SZ1313**

*Outer Tie Rod End Set*  
(Ø12.5\*Ø14/M16\*1.5)

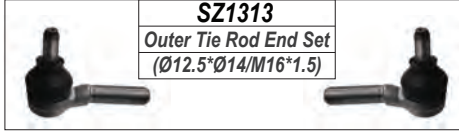

**SZ1014**

*Outer Tie Rod End*  
(Ø12.5\*Ø14/M16\*1.5)



**SZ1015**

*Outer Tie Rod End*  
(Ø12.5\*Ø14/M16\*1.5)



**SZ1513**

*Link Stabilizer*  
L=93



**SZ1514**

*Link Stabilizer*  
L=111.5

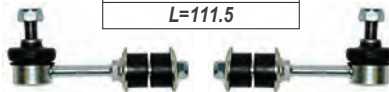

**LEFT**

**RIGHT**

**SUZUKI**

SWIFT

FRONT

ALL MODELS

Year

2008-2011

**SZ1016**  
Outer Tie Rod End  
(Ø12.5\*Ø14.1/M12\*1.25)

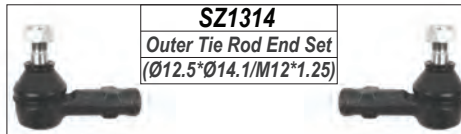

**SZ1314**  
Outer Tie Rod End Set  
(Ø12.5\*Ø14.1/M12\*1.25)

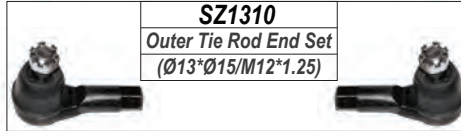

**SZ1310**  
Outer Tie Rod End Set  
(Ø13\*Ø15/M12\*1.25)

**SZ1016**  
Outer Tie Rod End  
(Ø12.5\*Ø14.1/M12\*1.25)



**SZ1413**  
Rack End  
(18\*1.5/12\*1.25/305)

**SZ1010**  
Outer Tie Rod End  
(Ø13\*Ø15/M12\*1.25)



**SZ1010**  
Outer Tie Rod End  
(Ø13\*Ø15/M12\*1.25)



**SZ1515**  
Link Stabilizer  
L=300



**SZ1911**  
Lower Ball Joint  
(Ø15)



**SZ2016**  
Lower Control Arm

**SZ2017**  
Lower Control Arm

**SZ1911**  
Lower Ball Joint  
(Ø15)



**SZ2811**  
Shock Mounting



**SZ2811**  
Shock Mounting



LEFT

RIGHT

**SUZUKI**

**SWIFT**

**FRONT**

**ALL MODELS**

*Year*

**2011-**

**SZ1315**  
Outer Tie Rod End Set  
(Ø13.1\*Ø15.5/M14\*1.5)

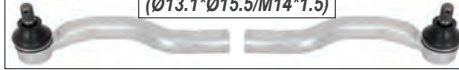

**SZ1018**  
Outer Tie Rod End  
(Ø13.1\*Ø15.5/M14\*1.5)



**SZ1414**  
Rack End  
(18\*1.5/14\*1.5/187)



**SZ1019**  
Outer Tie Rod End  
(Ø13.1\*Ø15.5/M14\*1.5)



**SZ1516**  
Link Stabilizer  
L=270



**SZ1910**  
Lower Ball Joint  
(Ø13.3)



**SZ2018**  
Lower Control Arm

**SZ2019**  
Lower Control Arm

**SZ1910**  
Lower Ball Joint  
(Ø13.3)



**SZ2812**  
Shock Mounting



**SZ2812**  
Shock Mounting



**LEFT**

**RIGHT**



**SUZUKI**

**SX4**

**FRONT**

**ALL MODELS**

*Year*

**2008-**

**SZ1020**  
Outer Tie Rod End  
(Ø13\*Ø15/M14\*1.5)



**SZ1013**  
Outer Tie Rod End  
(Ø13\*Ø15/M14\*1.5)

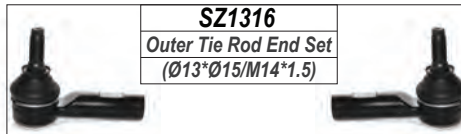

**SZ1316**  
Outer Tie Rod End Set  
(Ø13\*Ø15/M14\*1.5)

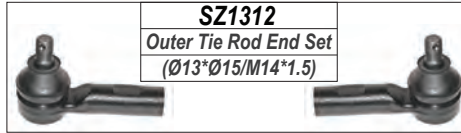

**SZ1312**  
Outer Tie Rod End Set  
(Ø13\*Ø15/M14\*1.5)

**SZ1415**  
Rack End  
(16\*1.0/14\*1.5/352.5)

**SZ1020**  
Outer Tie Rod End  
(Ø13\*Ø15/M14\*1.5)



**SZ1013**  
Outer Tie Rod End  
(Ø13\*Ø15/M14\*1.5)



**SZ1516**  
Link Stabilizer  
L=270



**SZ2200**  
Lower Control Arm



**SZ2201**  
Lower Control Arm

**LEFT**

**RIGHT**

**SUZUKI**

VITARA

FRONT

ALL MODELS

Year

1988-1998

**SZ2210**

Center Rod



**SZ1317**

Outer Tie Rod End Set  
(Ø13°Ø15/M14\*1.5)



**SZ1318**

Inner Tie Rod End Set  
(Ø13°Ø15/M14\*1.5)

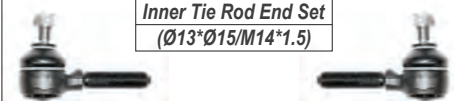

**SZ1017**

Outer Tie Rod End  
(Ø13°Ø15/M14\*1.5)



**SZ1110**

Inner Tie Rod End  
(Ø13°Ø15/M14\*1.5)



**SZ1017**

Outer Tie Rod End  
(Ø13°Ø15/M14\*1.5)



**SZ1912**

Lower Ball Joint  
(Ø16)



**SZ1912**

Lower Ball Joint  
(Ø16)



**SZ2022**

Lower Control Arm

**SZ2023**

Lower Control Arm

LEFT

RIGHT

**TATA**

**BOLT**

**FRONT**

**ALL MODELS**

*Year*

**2015-**

**TA1310**  
Outer Tie Rod End Set

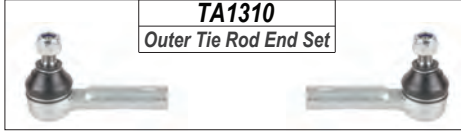

**TA1010**  
Outer Tie Rod End



**TA1410**  
Rack End  
(14\*1.5/14\*1.5/235)



**TA1011**  
Outer Tie Rod End



**TA1512**  
Link Stabilizer  
L=260



**TA1912**  
Lower Ball Joint



**TA1912**  
Lower Ball Joint

**TA2010**  
Lower Control Arm

**TA2011**  
Lower Control Arm

**LEFT**

**RIGHT**

**TATA**

**INDIGO.INDICA**

**FRONT**

**ALL MODELS**

*Year*

**2005-**

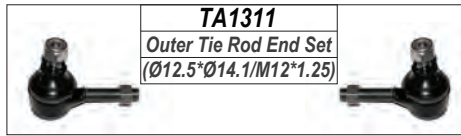

**TA1311**  
Outer Tie Rod End Set  
(Ø12.5\*Ø14.1/M12\*1.25)

**TA1012**  
Outer Tie Rod End  
(Ø12.5\*Ø14.1/M12\*1.25)

**TA1411**  
Rack End  
(14\*1.5/12\*1.25/307)

**TA1012**  
Outer Tie Rod End  
(Ø12.5\*Ø14.1/M12\*1.25)



**TA1510**  
Link Stabilizer  
L=98

**TA1913**  
Lower Ball Joint  
(Ø17)(ABS)



**TA2012**  
Lower Control Arm



**TA2013**  
Lower Control Arm



**TA1913**  
Lower Ball Joint  
(Ø17)(ABS)

**TA1914**  
Lower Ball Joint  
(Ø15)(NONABS)



**TA2014**  
Lower Control Arm



**TA2015**  
Lower Control Arm



**TA1915**  
Lower Ball Joint  
(Ø15)(NONABS)

**LEFT**

**RIGHT**

**TATA**

**TELCOLINE.WORKER FRONT**

**ALL MODELS**

*Year*

**2004-**

**TA2210**

Center Rod



**TA1312**

Outer Tie Rod End Set  
(Ø14.4\*Ø16.4/M16\*1.5)

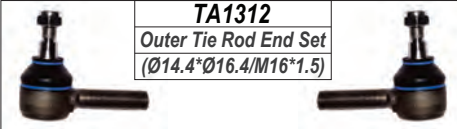

**TA1313**

Inner Tie Rod End Set  
(Ø14.67\*Ø16.5/M16\*1.5)

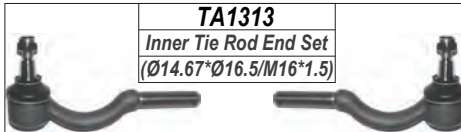

**TA1013**

Outer Tie Rod End  
(Ø14.4\*Ø16.4/M16\*1.5)



**TA1110 / TA1111**

Inner Tie Rod End  
(Ø14.67\*Ø16.5/M16\*1.5)



**TA1014**

Outer Tie Rod End  
(Ø14.4\*Ø16.4/M16\*1.5)



**TA1210 / TA1211**

Tie Rod Assembly



**TA1610**

Upper Ball Joint  
(Ø18.35)



**TA1610**

Upper Ball Joint  
(Ø18.35)



**TA1910**

Lower Ball Joint  
(Ø20.35)



**TA1910**

Lower Ball Joint  
(Ø20.35)



**TA1911**

Lower Ball Joint  
(Ø20.35)



**TA1911**

Lower Ball Joint  
(Ø20.35)



**LEFT**

**RIGHT**



**TATA**

**XENON**

**FRONT**

**ALL MODELS**

**Year**

**2008-**

**TA2310**

*Drag Link*



**TA1314**

*Inner/Outer Tie Rod End Set  
(Ø14.3\*Ø16.5/M16\*1.5)*

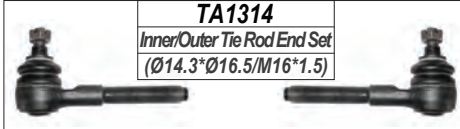

**TA1112**

*Outer Tie Rod End  
(Ø14.3\*Ø16.5/M16\*1.5)*



**TA1112 / TA1113**

*Inner Tie Rod End  
(Ø14.3\*Ø16.5/M16\*1.5)*



**TA1113**

*Outer Tie Rod End  
(Ø14.3\*Ø16.5/M16\*1.5)*



**TA1212**

*Tie Rod Assembly*



**TA1511**

*Link Stabilizer  
L=126*



**TA1610**

*Upper Ball Joint  
(Ø18.35)*



**TA1610**

*Upper Ball Joint  
(Ø18.35)*



**TA1911**

*Lower Ball Joint  
(Ø20.35)*



**TA1911**

*Lower Ball Joint  
(Ø20.35)*



**LEFT**

**RIGHT**

**TOYOTA**

86

**FRONT**

**ALL MODELS**

Year

2012-

**TO1310**  
Outer Tie Rod End Set  
(Ø13.09\*Ø15.4/M14\*1.5)

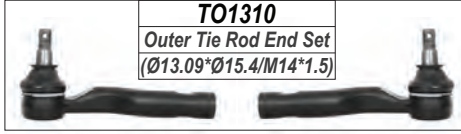

**TO1029**  
Outer Tie Rod End  
(Ø13.09\*Ø15.4/M14\*1.5)



**TO1411**  
Rack End  
(16\*1.5/14\*1.5/226)



**TO1030**  
Outer Tie Rod End  
(Ø13.09\*Ø15.4/M14\*1.5)



**TO1510**  
Link Stabilizer  
L=245



**SU2118**  
Lower Control Arm Bush



**TO1917**  
Lower Ball Joint  
(Ø17.5)



**TO1917**  
Lower Ball Joint  
(Ø17.5)



**TO2010**  
Lower Control Arm

**TO2011**  
Lower Control Arm

**SU2119**  
Lower Control Arm Bush



86

**REAR**

**SU1512**  
Link Stabilizer  
L=107.4



**LEFT**

**RIGHT**

**TOYOTA**

**AURIS**

**FRONT**

**ALL MODELS**

*Year*

**2007-**

**TO1311**  
Outer Tie Rod End Set  
(Ø13.6\*Ø16.1/M15\*1.5)

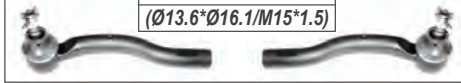

**TO1010**  
Outer Tie Rod End  
(Ø13.6\*Ø16.1/M15\*1.5)



**TO1412**  
Rack End  
(14\*1.5/15\*1.5/233)



**TO1011**  
Outer Tie Rod End  
(Ø13.6\*Ø16.1/M15\*1.5)



**TO1511**  
Link Stabilizer  
L=360



**TO2111**  
Lower Control Arm Bush



**TO1918**  
Lower Ball Joint  
(Ø17.5)



**TO1918**  
Lower Ball Joint  
(Ø17.5)



**TO2012**  
Lower Control Arm



**TO2013**  
Lower Control Arm

**TO2811**  
Shock Mounting



**TO2110**  
Lower Control Arm Bush



**TO2811**  
Shock Mounting



**AURIS**

**REAR**

**TO1512**  
Link Stabilizer  
L=107.4



**LEFT**

**RIGHT**

**TOYOTA**

**AVANZA**

**FRONT**

**ALL MODELS**

*Year*

**2006-2011**

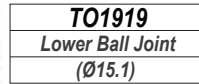
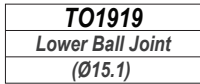
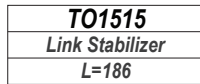
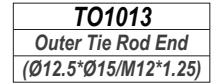
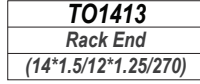
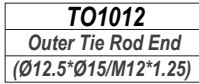
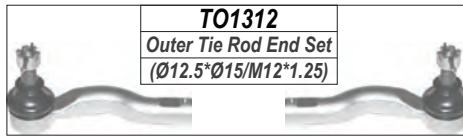

**LEFT**

**RIGHT**

**TOYOTA**

**AVANZA**

**FRONT**

**ALL MODELS**

*Year*

**2011-**

**TO1312**  
Outer Tie Rod End Set  
(Ø12.5\*Ø15/M12\*1.25)

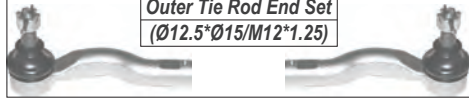

**TO1012**  
Outer Tie Rod End  
(Ø12.5\*Ø15/M12\*1.25)



**TO1413**  
Rack End  
(14\*1.5/12\*1.25/270)



**TO1013**  
Outer Tie Rod End  
(Ø12.5\*Ø15/M12\*1.25)



**TO1515**  
Link Stabilizer  
L=186



**TO2135**  
Lower Control Arm Bush



**TO1920**  
Lower Ball Joint  
(Ø18.3)



**TO1920**  
Lower Ball Joint  
(Ø18.3)

**TO2016**  
Lower Control Arm

**TO2017**  
Lower Control Arm



**TO2134**  
Lower Control Arm Bush

**LEFT**

**RIGHT**



**TOYOTA**

**AVENSIS**

**FRONT**

**ALL MODELS**

*Year*

**2006-2009**

**TO1313**  
Outer Tie Rod End Set  
(Ø12.5\*Ø15/M16\*1.5)

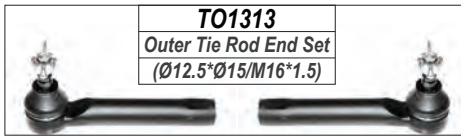

**TO1014**  
Outer Tie Rod End  
(Ø12.5\*Ø15/M16\*1.5)

**TO1414**  
Rack End  
(14\*1.5/16\*1.5/304)

**TO1014**  
Outer Tie Rod End  
(Ø12.5\*Ø15/M16\*1.5)

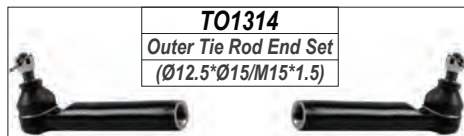

**TO1314**  
Outer Tie Rod End Set  
(Ø12.5\*Ø15/M15\*1.5)

**TO1015**  
Outer Tie Rod End  
(Ø12.5\*Ø15/M15\*1.5)

**TO1415**  
Rack End  
(14\*1.5/15\*1.5/369)

**TO1015**  
Outer Tie Rod End  
(Ø12.5\*Ø15/M15\*1.5)



**NI1542**  
Link Stabilizer  
L=285



**TO1921**  
Lower Ball Joint  
(Ø17.2)



**TO1921**  
Lower Ball Joint  
(Ø17.2)



**TO2112**  
Lower Control Arm Bush

**TO1922**  
Lower Ball Joint  
(Ø15)



**TO1922**  
Lower Ball Joint  
(Ø15)



**TO2018**  
Lower Control Arm



**TO2019**  
Lower Control Arm

**TO2813**  
Shock Mounting



**TO2113**  
Lower Control Arm Bush



**TO2813**  
Shock Mounting



**AVENSIS**

**REAR**

**TO1513 / TO1514**  
Link Stabilizer  
L=100



**LEFT**

**RIGHT**

**TOYOTA**

**AYGO**

**FRONT**

**ALL MODELS**

*Year*

**2011-**

**CI1013**  
Outer Tie Rod End  
(Ø12.5\*Ø15/M12\*1.25)

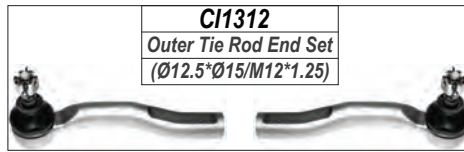

**CI1312**  
Outer Tie Rod End Set  
(Ø12.5\*Ø15/M12\*1.25)

**CI1014**  
Outer Tie Rod End  
(Ø12.5\*Ø15/M12\*1.25)



**CI1412**  
Rack End  
(14\*1.5/12\*1.25/222)



**CI1512**  
Link Stabilizer  
L=92



**CI2114**  
Lower Control Arm Bush



**CI1913**  
Lower Ball Joint  
(Ø13.5)



**CI1913**  
Lower Ball Joint  
(Ø13.5)



**CI2014**  
Lower Control Arm

**CI2015**  
Lower Control Arm

**CI2115**  
Lower Control Arm Bush



**CI2812**  
Shock Mounting



**CI2812**  
Shock Mounting



**LEFT**

**RIGHT**

**TOYOTA**

**CAMRY**

**FRONT**

**ALL MODELS**

*Year*

**1992-2001**

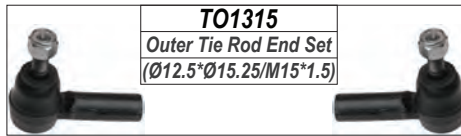

**TO1315**  
Outer Tie Rod End Set  
(Ø12.5\*Ø15.25/M15\*1.5)

**TO1016**  
Outer Tie Rod End  
(Ø12.5\*Ø15.25/M15\*1.5)

**TO1416**  
Rack End  
(14\*1.5/15\*1.5/336)

**TO1016**  
Outer Tie Rod End  
(Ø12.5\*Ø15.25/M15\*1.5)



**TO1516**  
Link Stabilizer  
L=60



**TO1517 / TO1518**  
Link Stabilizer  
L=285



**TO2115**  
Lower Control Arm Bush



**TO1923**  
Lower Ball Joint  
(Ø17.5)

**TO1923**  
Lower Ball Joint  
(Ø17.5)

**TO2020**  
Lower Control Arm

**TO2021**  
Lower Control Arm

**TO2814**  
Shock Mounting

**TO2814**  
Shock Mounting



**TO2114**  
Lower Control Arm Bush

**CAMRY**

**REAR**

**TO1519**  
Link Stabilizer  
L=195



**TO1520**  
Link Stabilizer  
L=70



**LEFT**

**RIGHT**

**TOYOTA**

**CAMRY**

**FRONT**

**ALL MODELS**

*Year*

**2001-**

**TO1316**  
Outer Tie Rod End Set  
(Ø12.5\*Ø15/M15\*1.5)

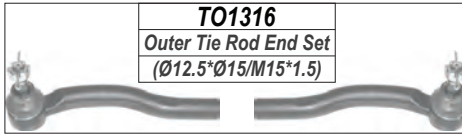

**TO1017**  
Outer Tie Rod End  
(Ø12.5\*Ø15/M15\*1.5)

**TO1416**  
Rack End  
(14\*1.5/15\*1.5/336)

**TO1018**  
Outer Tie Rod End  
(Ø12.5\*Ø15/M15\*1.5)



**TO1317**  
Outer Tie Rod End Set  
(Ø13.5\*Ø16/M15\*1.5)

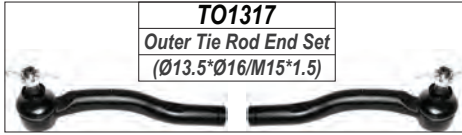

**TO1019**  
Outer Tie Rod End  
(Ø13.5\*Ø16/M15\*1.5)

**TO1417**  
Rack End  
(14\*1.5/15\*1.5/238)

**TO1020**  
Outer Tie Rod End  
(Ø13.5\*Ø16/M15\*1.5)

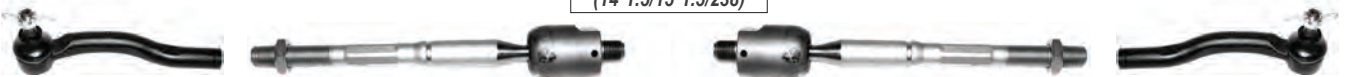

**TO1521**  
Link Stabilizer  
L=260



**TO1522**  
Link Stabilizer  
L=260

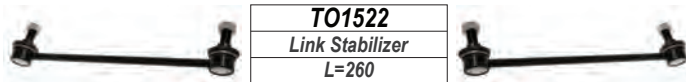

**TO1924**  
Lower Ball Joint  
(Ø17.5)

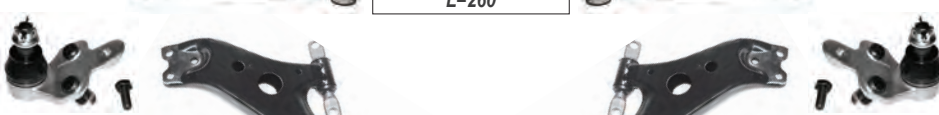

**TO1925**  
Lower Ball Joint  
(Ø17.5)

**TO2116**  
Lower Control Arm Bush



**TO2022**  
Lower Control Arm

**TO2023**  
Lower Control Arm

**TO1940**  
Lower Ball Joint  
(Ø15).8



**TO1941**  
Lower Ball Joint  
(Ø15.8)

**TO2116**  
Lower Control Arm Bush



**TO2024**  
Lower Control Arm  
Import Only

**TO2025**  
Lower Control Arm  
Import Only

**TO2815**  
Shock Mounting



**TO2815**  
Shock Mounting



**CAMRY**

**REAR**

**TO1523**  
Link Stabilizer  
L=237

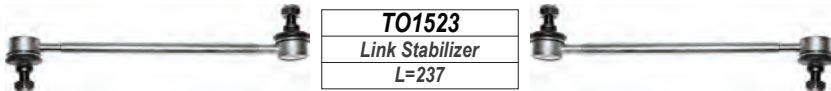

**LEFT**

**RIGHT**

**TOYOTA**

**CH-R**

**FRONT**

**ALL MODELS**

**Year**

**2017-**

**TO1318**  
Outer Tie Rod End Set  
(Ø13.6\*Ø16.1/M12\*1.25)



**TO1031**  
Outer Tie Rod End  
(Ø13.6\*Ø16.1/M12\*1.25)



**TO1032**  
Outer Tie Rod End  
(Ø13.6\*Ø16.1/M12\*1.25)



**TO1524**  
Link Stabilizer  
L=330



**TO1918**  
Lower Ball Joint  
(Ø17.5)



**TO1918**  
Lower Ball Joint  
(Ø17.5)



**TO2026**  
Lower Control Arm



**TO2027**  
Lower Control Arm



**TO2810**  
Stabilizer Bar Bush



**LEFT**

**RIGHT**



**TOYOTA**

**CONDOR FRONT  
STALLION, VENTURE**

**4X2**

*Year*

**2000-2005**

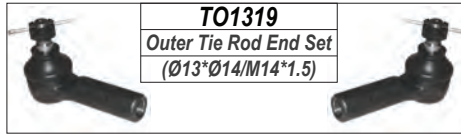

**TO1319**  
Outer Tie Rod End Set  
(Ø13\*Ø14/M14\*1.5)

**TO1033**  
Outer Tie Rod End  
(Ø13\*Ø14/M14\*1.5)



**TO1418**  
Rack End  
(14\*1.5/14\*1.5/315)



**TO1033**  
Outer Tie Rod End  
(Ø13\*Ø14/M14\*1.5)



**TO1611**  
Upper Ball Joint  
(Ø15.4)



**TO1710**  
Upper Control Arm  
48067-28060

**TO1711**  
Upper Control Arm  
48067-28060



**TO1611**  
Upper Ball Joint  
(Ø15.4)

**FT1910**  
Lower Ball Joint  
(Ø17)



**TO2028**  
Lower Control Arm  
48069-28070

**TO2029**  
Lower Control Arm  
48069-28070

**FT1910**  
Lower Ball Joint  
(Ø17)



**LEFT**

**RIGHT**

**TOYOTA**

CONDOR

FRONT

4X4

Year

2000-2005

**TO1320**  
Outer Tie Rod End Set  
(Ø12.4\*Ø14.9/M14\*1.5)



**TO1021**  
Outer Tie Rod End  
(Ø12.4\*Ø14.9/M14\*1.5)



**FT1410**  
Rack End  
(14\*1.5/14\*1.5/296)



**TO1022**  
Outer Tie Rod End  
(Ø12.4\*Ø14.9/M14\*1.5)



**TO1525**  
Link Stabilizer  
L=

(N/A)

**TO1612**  
Upper Ball Joint

(N/A)



**TO1612**  
Upper Ball Joint

(N/A)

**TO1712**  
Upper Control Arm  
48067-29135

**TO1713**  
Upper Control Arm  
48067-29135

**TO1910**  
Lower Ball Joint  
(Ø18)



**TO1910**  
Lower Ball Joint  
(Ø18)



**TO2030**  
Lower Control Arm  
48069-28090

(N/A)

**TO2031**  
Lower Control Arm  
48069-28090

(N/A)

LEFT

RIGHT

**TOYOTA**

CONQUEST

FRONT

EE80.AE82

Year

1984-1988

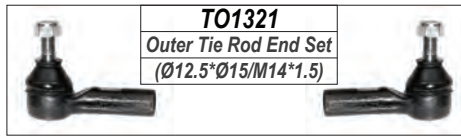

**TO1321**  
Outer Tie Rod End Set  
(Ø12.5\*Ø15/M14\*1.5)

**TO1034**  
Outer Tie Rod End  
(Ø12.5\*Ø15/M14\*1.5)

**TO1418**  
Rack End  
(14\*1.5/14\*1.5/315)

**TO1034**  
Outer Tie Rod End  
(Ø12.5\*Ø15/M14\*1.5)



**TO1911**  
Lower Ball Joint  
(Ø16)

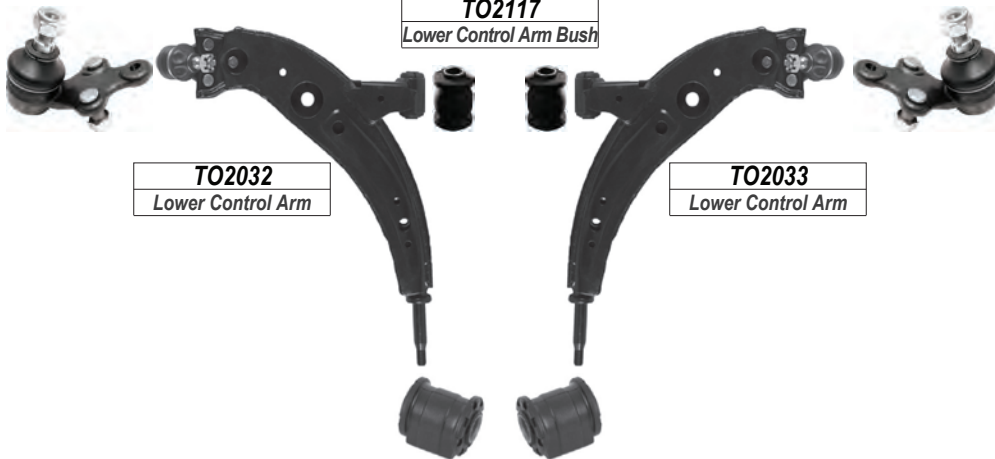

**TO2117**  
Lower Control Arm Bush

**TO1911**  
Lower Ball Joint  
(Ø16)

**TO2032**  
Lower Control Arm

**TO2033**  
Lower Control Arm

**TO2137**  
Lower Control Arm Bush

CONQUEST

REAR

**TO2140**  
Lower Control Arm Bush



LEFT

RIGHT

**TOYOTA**

CONQUEST.TAZZ FRONT

EE90.AE92.AE93

Year

1988-2006

**TO1321**  
Outer Tie Rod End Set  
(Ø12.5\*Ø15/M14\*1.5)

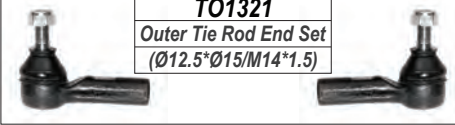

**TO1034**  
Outer Tie Rod End  
(Ø12.5\*Ø15/M14\*1.5)

**TO1418**  
Rack End  
(14\*1.5/14\*1.5/315)(M/S)

**TO1034**  
Outer Tie Rod End  
(Ø12.5\*Ø15/M14\*1.5)



**TO1419**  
Rack End  
(14\*1.5/14\*1.5/318)(P/S)



**TO2117**  
Lower Control Arm Bush

**CY1910**  
Lower Ball Joint  
(Ø15)(96-)



**CY1910**  
Lower Ball Joint  
(Ø15)(96-)

**TO2034**  
Lower Control Arm(96-)

**TO2035**  
Lower Control Arm(96-)

**TO2118**  
Lower Control Arm Bush

**TO1912**  
Lower Ball Joint  
(Ø15.5)



**TO1913**  
Lower Ball Joint  
(Ø15.5)

**TO2036**  
Lower Control Arm

**TO2037**  
Lower Control Arm

**TO2816**  
Shock Mounting



**TO2816**  
Shock Mounting



**TO2136**  
Lower Control Arm Bush

CONQUEST.TAZZ REAR

**TO1520**  
Link Stabilizer  
L=70



**TO1526**  
Link Stabilizer  
L=104



LEFT

RIGHT

**TOYOTA**

**COROLLA**

**FRONT**

**KE30.KE70.TE71**

*Year*

**1975-1989**

**TO1322**  
Outer Tie Rod End Set  
(Ø13\*Ø14/M14\*1.5)

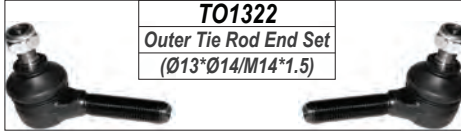

**TO1345**  
Inner Tie Rod End Set  
(Ø12.8\*Ø14/M14\*1.5)

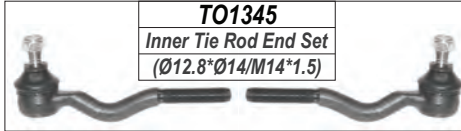

**TO1119**  
Inner Tie Rod End  
(Ø12.8\*Ø14/M14\*1.5)



**TO1035**  
Outer Tie Rod End  
(Ø13\*Ø14/M14\*1.5)



**TO1035**  
Outer Tie Rod End  
(Ø13\*Ø14/M14\*1.5)



**TO1346**  
Outer Tie Rod End Set  
(Ø12.8\*Ø14/M14\*1.5)



**TO1420**  
Rack End  
(14\*1.5/14\*1.5/145)



**TO1036**  
Outer Tie Rod End  
(Ø12.8\*Ø14/M14\*1.5)



**TO1036**  
Outer Tie Rod End  
(Ø12.8\*Ø14/M14\*1.5)



**TO1914**  
Lower Ball Joint  
(Ø14.67)



**TO1914**  
Lower Ball Joint  
(Ø14.67)



**LEFT**

**RIGHT**



**TOYOTA**

**COROLLA**

**FRONT**

**EE80.AE82**

*Year*

**1984-1988**

**TO1321**  
Outer Tie Rod End Set  
(Ø12.5\*Ø15/M14\*1.5)

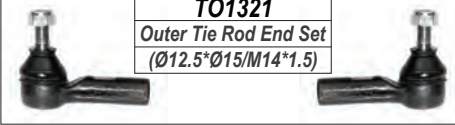

**TO1034**  
Outer Tie Rod End  
(Ø12.5\*Ø15/M14\*1.5)

**TO1418**  
Rack End  
(14\*1.5/14\*1.5/315)

**TO1034**  
Outer Tie Rod End  
(Ø12.5\*Ø15/M14\*1.5)



**TO1911**  
Lower Ball Joint  
(Ø16)



**TO1911**  
Lower Ball Joint  
(Ø16)

**TO2117**  
Lower Control Arm Bush

**TO2032**  
Lower Control Arm

**TO2033**  
Lower Control Arm

**TO2137**  
Lower Control Arm Bush

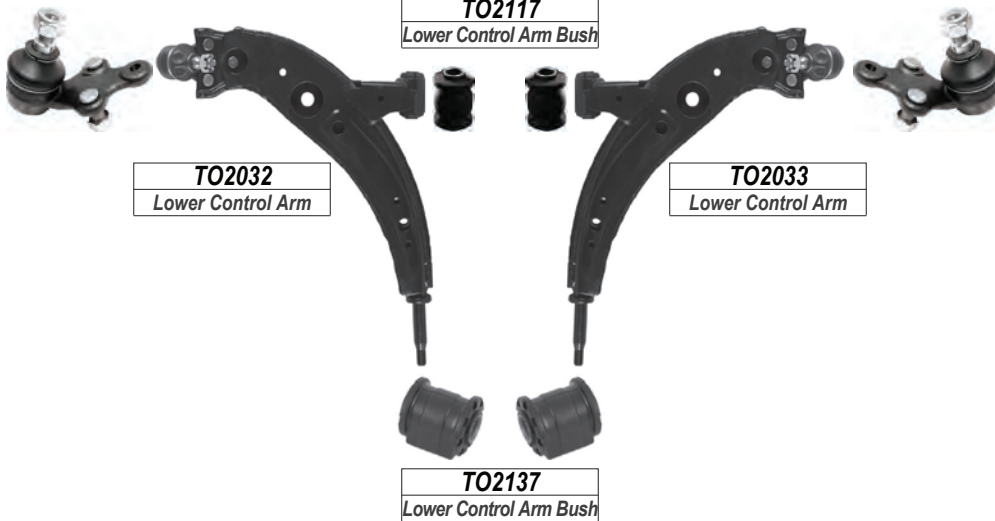

**TO2817**  
Shock Mounting



**TO2817**  
Shock Mounting



**COROLLA**

**REAR**

**TO2140**  
Lower Control Arm Bush



**LEFT**

**RIGHT**

**TOYOTA**
**COROLLA**
**FRONT**
**EE90.AE92.AE93**

Year

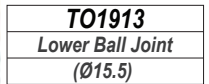
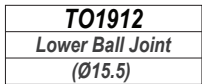
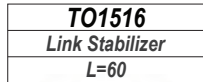
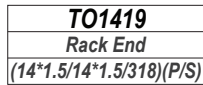
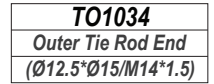
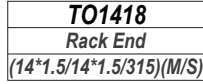
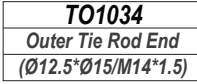
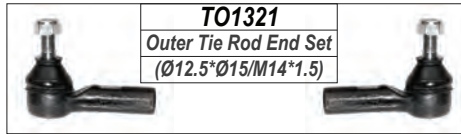
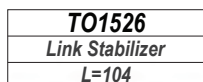
**1988-1996**

**COROLLA**
**REAR**

**LEFT**
**RIGHT**

**TOYOTA**

**COROLLA  
(RSI SHAPE)**

**FRONT**

**EE110.AE111.AE112**

*Year*

**1996-2002**

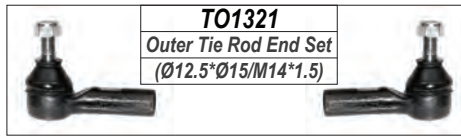

**TO1321**  
Outer Tie Rod End Set  
(Ø12.5\*Ø15/M14\*1.5)

**TO1034**  
Outer Tie Rod End  
(Ø12.5\*Ø15/M14\*1.5)

**TO1418**  
Rack End  
(14\*1.5/14\*1.5/315)(M/S)

**TO1034**  
Outer Tie Rod End  
(Ø12.5\*Ø15/M14\*1.5)



**TO1419**  
Rack End  
(14\*1.5/14\*1.5/318)(P/S)



**TO1421**  
Rack End  
(14\*1.5/14\*1.5/329)(M/S)



**TO1527**  
Link Stabilizer  
L=55



**TO2117**  
Lower Control Arm Bush

**CY1910**  
Lower Ball Joint  
(Ø15)



**TO2034**  
Lower Control Arm

**TO2035**  
Lower Control Arm



**CY1910**  
Lower Ball Joint  
(Ø15)

**TO2118**  
Lower Control Arm Bush

**TO2818**  
Shock Mounting



**TO2818**  
Shock Mounting



**COROLLA  
(RSI SHAPE)**

**REAR**

**TO1526**  
Link Stabilizer  
L=104



**LEFT**

**RIGHT**

**TOYOTA**

**COROLLA RUNX**

**FRONT**

**F11.KS1.GF2**

*Year*

**2002-2008**

**TO1323**  
Outer Tie Rod End Set  
(Ø12.55\*Ø15/M14\*1.5)

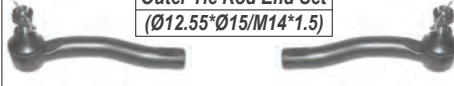

**TO1037**  
Outer Tie Rod End  
(Ø12.55\*Ø15/M14\*1.5)



**TO1422**  
Rack End  
(14\*1.5/14\*1.5/274)



**TO1038**  
Outer Tie Rod End  
(Ø12.55\*Ø15/M14\*1.5)



**TO1528**  
Link Stabilizer  
L=285



**NI1542**  
Link Stabilizer  
L=285



**TO2112**  
Lower Control Arm Bush



**CY1910**  
Lower Ball Joint  
(Ø15)



**CY1910**  
Lower Ball Joint  
(Ø15)



**TO2018**  
Lower Control Arm



**TO2019**  
Lower Control Arm



**TO2113**  
Lower Control Arm Bush



**TO2819**  
Shock Mounting



**TO2819**  
Shock Mounting



**COROLLA RUNX**

**REAR**

**TO1513 / TO1514**  
Link Stabilizer  
L=100



**LEFT**

**RIGHT**

**TOYOTA**

**COROLLA FRONT  
PROFESSIONAL / QUEST**

**ALL MODELS**

Year

2008-

**TO1039**  
Outer Tie Rod End  
(Ø12.5\*Ø15/M16\*1.5)

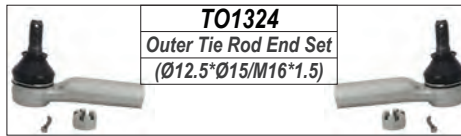

**TO1324**  
Outer Tie Rod End Set  
(Ø12.5\*Ø15/M16\*1.5)

**TO1414**  
Rack End  
(14\*1.5/16\*1.5/304)



**TO1039**  
Outer Tie Rod End  
(Ø12.5\*Ø15/M16\*1.5)

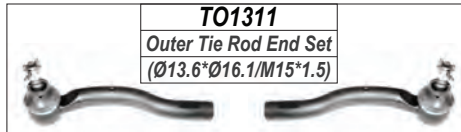

**TO1311**  
Outer Tie Rod End Set  
(Ø13.6\*Ø16.1/M15\*1.5)

**TO1010**  
Outer Tie Rod End  
(Ø13.6\*Ø16.1/M15\*1.5)



**TO1412**  
Rack End  
(14\*1.5/15\*1.5/233)



**TO1011**  
Outer Tie Rod End  
(Ø13.6\*Ø16.1/M15\*1.5)



**TO1511**  
Link Stabilizer  
L=360



**TO2110**  
Lower Control Arm Bush



**TO1918**  
Lower Ball Joint  
(Ø17.5)



**TO1918**  
Lower Ball Joint  
(Ø17.5)



**TO2012**  
Lower Control Arm

**TO2013**  
Lower Control Arm

**TO2811**  
Shock Mounting



**TO2811**  
Shock Mounting



**TO2111**  
Lower Control Arm Bush



**COROLLA REAR  
PROFESSIONAL / QUEST**

**TO1512**  
Link Stabilizer  
L=107.4



**LEFT**

**RIGHT**



**TOYOTA**

**COROLLA(VERSO) FRONT**

**ALL MODELS**

Year

**2004-2009**

**TO1313**  
Outer Tie Rod End Set  
(Ø12.5\*Ø15/M16\*1.5)

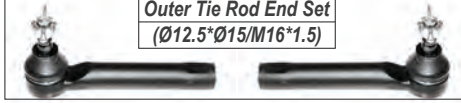

**TO1014**  
Outer Tie Rod End  
(Ø12.5\*Ø15/M16\*1.5)

**TO1414**  
Rack End  
(14\*1.5/16\*1.5/304)

**TO1014**  
Outer Tie Rod End  
(Ø12.5\*Ø15/M16\*1.5)



**NI1542**  
Link Stabilizer  
L=285



**TO2112**  
Lower Control Arm Bush

**CY1910**  
Lower Ball Joint  
(Ø15)



**CY1910**  
Lower Ball Joint  
(Ø15)

**TO2018**  
Lower Control Arm

**TO2019**  
Lower Control Arm

**TO2820**  
Shock Mounting



**TO2113**  
Lower Control Arm Bush

**TO2820**  
Shock Mounting



**LEFT**

**RIGHT**

**TOYOTA**

**COROLLA(VERSO) FRONT**

**ALL MODELS**

Year

**2009-**

**TO1347**  
Outer Tie Rod End Set  
( $\varnothing 12.25 \times \varnothing 15 / M16 \times 1.5$ )

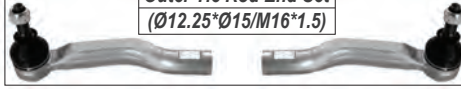

**TO1057**  
Outer Tie Rod End  
( $\varnothing 12.5 \times \varnothing 15 / M16 \times 1.5$ )



**TO1434**  
Rack End  
( $14 \times 1.5 / 16 \times 1.5 / 243$ )



**TO1058**  
Outer Tie Rod End  
( $\varnothing 12.5 \times \varnothing 15 / M16 \times 1.5$ )



**TO1511**  
Link Stabilizer  
L=360



**TO2110**  
Lower Control Arm Bush



**TO1918**  
Lower Ball Joint  
( $\varnothing 17.5$ )



**TO1918**  
Lower Ball Joint  
( $\varnothing 17.5$ )



**TO2012**  
Lower Control Arm



**TO2013**  
Lower Control Arm



**TO2111**  
Lower Control Arm Bush



**TO2831**  
Shock Mounting



**TO2831**  
Shock Mounting



**LEFT**

**RIGHT**

**TOYOTA**

**CRESSIDA**

**FRONT**

**ALL MODELS**

*Year*

**1986-**

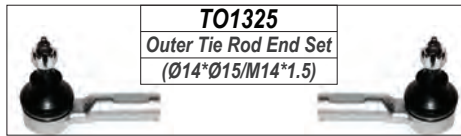

**TO1023**  
Outer Tie Rod End Set  
(Ø14\*Ø15/M14\*1.5)



**TO1023**  
Outer Tie Rod End Set  
(Ø14\*Ø15/M14\*1.5)



**TO1926**  
Lower Ball Joint  
(Ø15.7)



**TO2038**  
Lower Control Arm



**TO2039**  
Lower Control Arm

**TO1926**  
Lower Ball Joint  
(Ø15.7)



**LEFT**

**RIGHT**

**TOYOTA**

ETIOS

FRONT

ALL MODELS

Year

2012-

**TO1326**  
Outer Tie Rod End Set  
(Ø12.5\*Ø15/M12\*1.25)

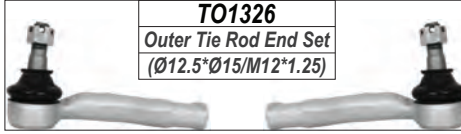

**TO1024**  
Outer Tie Rod End  
(Ø12.5\*Ø15/M12\*1.25)



**TO1410**  
Rack End  
(14\*1.5/12\*1.25/270)



**TO1025**  
Outer Tie Rod End  
(Ø12.5\*Ø15/M12\*1.25)



**TO1529**  
Link Stabilizer  
L=92



**TO2120**  
Lower Control Arm Bush



**TO2119**  
Lower Control Arm Bush



**TO1927**  
Lower Ball Joint  
(Ø13.4)



**TO1927**  
Lower Ball Joint  
(Ø13.4)



**TO2040**  
Lower Control Arm



**TO2041**  
Lower Control Arm

**TO2821**  
Shock Mounting



**TO2821**  
Shock Mounting



LEFT

RIGHT

**TOYOTA**

**FJ CRUISER**

**FRONT**

**ALL MODELS**

Year

**2011-**

**TO1327**  
Outer Tie Rod End Set  
(Ø15.3\*Ø17/M16\*1.5)

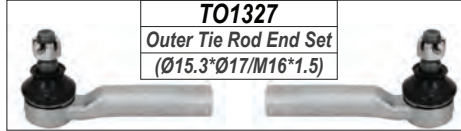

**TO1040**  
Outer Tie Rod End  
(Ø15.3\*Ø17/M16\*1.5)

**TO1423**  
Rack End  
(22\*1.5/15\*1.5/285.5)

**TO1040**  
Outer Tie Rod End  
(Ø15.3\*Ø17/M16\*1.5)



**TO1530 / TO1531**  
Link Stabilizer  
L=140



**TO1610**  
Upper Ball Joint  
(Ø15.8)



**TO1810**  
Upper Control Arm Bush

**TO1610**  
Upper Ball Joint  
(Ø15.8)



**TO1714**  
Upper Control Arm

**TO1715**  
Upper Control Arm

**TO1928**  
Lower Ball Joint  
(Ø17.4)



**TO1928**  
Lower Ball Joint  
(Ø17.4)



**TO2042**  
Lower Control Arm

**TO2043**  
Lower Control Arm

**FJ CRUISER**

**REAR**

**TO1545**  
Link Stabilizer  
L=173.5



**LEFT**

**RIGHT**



**TOYOTA**

**FORTUNER**

**FRONT**

**ALL MODELS**

*Year*

**2006-2016**

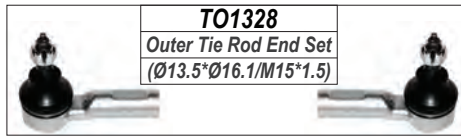

**TO1328**  
Outer Tie Rod End Set  
(Ø13.5\*Ø16.1/M15\*1.5)

**TO1041**  
Outer Tie Rod End  
(Ø13.5\*Ø16.1/M15\*1.5)

**CY1411**  
Rack End  
(14\*1.5/15\*1.5/298)

**TO1041**  
Outer Tie Rod End  
(Ø13.5\*Ø16.1/M15\*1.5)



**TO1530 / TO1531**  
Link Stabilizer  
L=140

**TO1613**  
Upper Ball Joint  
(Ø15)



**TO1811**  
Upper Control Arm Bush



**TO1613**  
Upper Ball Joint  
(Ø15)

**TO1716**  
Upper Control Arm

**TO1717**  
Upper Control Arm

**TO2121**  
Lower Control Arm Bush

**TO1915**  
Lower Ball Joint  
(Ø16.7)



**TO1915**  
Lower Ball Joint  
(Ø16.7)

**TO2044**  
Lower Control Arm

**TO2045**  
Lower Control Arm

**TO2122**  
Lower Control Arm Bush

**TO2822**  
Shock Mounting



**TO2822**  
Shock Mounting



**TO2823**  
Shock Mounting



**TO2823**  
Shock Mounting



**LEFT**

**RIGHT**

**TOYOTA**

**FORTUNER**

**FRONT**

**ALL MODELS**

*Year*

**2016-**

**TO1028**  
Outer Tie Rod End  
(Ø15.3\*Ø17.1/M16\*1.5)

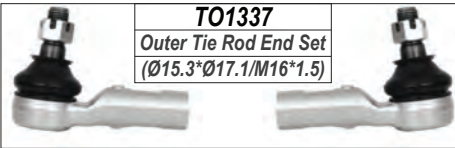

**TO1337**  
Outer Tie Rod End Set  
(Ø15.3\*Ø17.1/M16\*1.5)

**TO1425**  
Rack End  
(14\*1.5/16\*1.5/296)

**TO1028**  
Outer Tie Rod End  
(Ø15.3\*Ø17.1/M16\*1.5)



**TO1530 / TO1531**  
Link Stabilizer  
L=140



**TO1613**  
Upper Ball Joint  
(Ø15)



**TO1811**  
Upper Control Arm Bush

**TO1716**  
Upper Control Arm

**TO1717**  
Upper Control Arm

**TO1613**  
Upper Ball Joint  
(Ø15)



**TO1915**  
Lower Ball Joint  
(Ø16.7)



**TO2052**  
Lower Control Arm

**TO2053**  
Lower Control Arm

**TO1915**  
Lower Ball Joint  
(Ø16.7)



**LEFT**

**RIGHT**

**TOYOTA**

HI-ACE

FRONT

RH11.RH20

Year

1969-1984

**TO1026**  
Outer Tie Rod End  
(Ø14.6\*Ø16/M17\*1.5)



**TO1110**  
Inner Tie Rod End  
(Ø15.4\*Ø18.3/M14\*1.5)



**TO1026**  
Outer Tie Rod End  
(Ø14.6\*Ø16/M17\*1.5)



**TO1532 / TO1533**  
Link Stabilizer  
L=73



**TO1614**  
Upper Ball Joint  
(Ø15)



**TO1614**  
Upper Ball Joint  
(Ø15)



**TO1916**  
Lower Ball Joint  
(Ø17.75)



**TO1916**  
Lower Ball Joint  
(Ø17.75)



LEFT

RIGHT

**TOYOTA**

**HI-ACE**

**FRONT**

**YH50 / YH60**

*Year*

**1983-1992**

**TO2210**

Center Rod



**TO1331**

Outer Tie Rod End Set  
(Ø14.5\*Ø16/M17\*1.5)



**TO1332**

Inner Tie Rod End Set  
(Ø14.5\*Ø16/M17\*1.5)

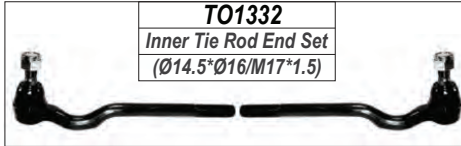

**TO1027**

Outer Tie Rod End  
(Ø14.5\*Ø16/M17\*1.5)



**TO1111**

Inner Tie Rod End  
(Ø14.5\*Ø16/M17\*1.5)



**TO1027**

Outer Tie Rod End  
(Ø14.5\*Ø16/M17\*1.5)



**TO1534**

Link Stabilizer  
L=146



**TO1615**

Upper Ball Joint  
(Ø17)



**TO1615**

Upper Ball Joint  
(Ø17)



**FT1910**

Lower Ball Joint  
(Ø16.8)



**FT1910**

Lower Ball Joint  
(Ø16.8)



**TO2130**

Lower Control Arm Bush



**CA1910**

Lower Ball Joint  
(Ø18)



**CA2010**

Lower Control Arm



**CA2011**

Lower Control Arm



**CA1910**

Lower Ball Joint  
(Ø18)

**LEFT**

**RIGHT**

**TOYOTA**

HI-ACE

FRONT

YH53 / YH63

Year

1992-2008

**CA1010**  
Outer Tie Rod End  
(Ø14.6\*Ø16.5/M17\*1.5)

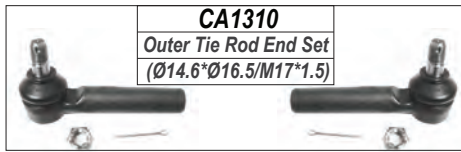

**CA1310**  
Outer Tie Rod End Set  
(Ø14.6\*Ø16.5/M17\*1.5)

**CA1410**  
Rack End  
(14\*1.5/17\*1.5/276)

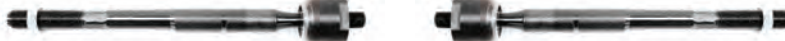

**CA1010**  
Outer Tie Rod End  
(Ø14.6\*Ø16.5/M17\*1.5)



**CA1011**  
Outer Tie Rod End  
(Ø14.7\*Ø16/M15\*1.5)

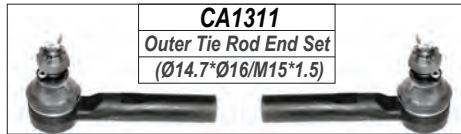

**CA1311**  
Outer Tie Rod End Set  
(Ø14.7\*Ø16/M15\*1.5)

**CA1411**  
Rack End  
(14\*1.5/15\*1.5/274)



**CA1011**  
Outer Tie Rod End  
(Ø14.7\*Ø16/M15\*1.5)



**TO1532 / TO1533**  
Link Stabilizer  
L=73

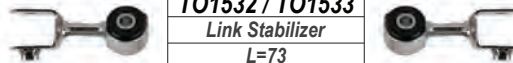

**TO1534**  
Link Stabilizer  
L=146

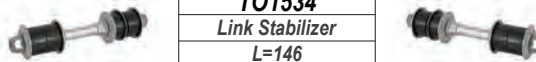

**CM1510**  
Link Stabilizer  
L=159.5

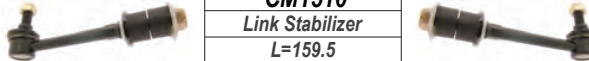

**CA1611**  
Upper Ball Joint  
(Ø17)



**FT1710**  
Upper Control Arm



**FT1711**  
Upper Control Arm

**CA1611**  
Upper Ball Joint  
(Ø17)



**FT1910**  
Lower Ball Joint  
(Ø16.8)



**TO2130**  
Lower Control Arm Bush



**FT1910**  
Lower Ball Joint  
(Ø16.8)



**CA1910**  
Lower Ball Joint  
(Ø18)



**CA2010**  
Lower Control Arm



**CA2011**  
Lower Control Arm



**CA1910**  
Lower Ball Joint  
(Ø18)

LEFT

RIGHT



**TOYOTA**

**HILUX**

**FRONT**

Year

**RN20 / RN25 / RN30 / RN40 / RN22 / RN31 / RN41**

**1974-1984**

**TO2211**

Center Rod

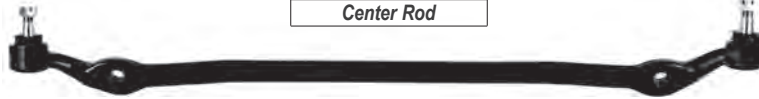

**TO1331**

Outer Tie Rod End Set  
(Ø14.5\*Ø16/M17\*1.5)



**TO1333**

Inner Tie Rod End Set  
(Ø14.5\*Ø16/M17\*1.5)



**TO1027**

Outer Tie Rod End  
(Ø14.5\*Ø16/M17\*1.5)



**TO1112**

Inner Tie Rod End  
(Ø14.5\*Ø16/M17\*1.5)



**TO1027**

Outer Tie Rod End  
(Ø14.5\*Ø16/M17\*1.5)



**TO1210**

Tie Rod Assembly



**TO1616**

Upper Ball Joint  
(Ø15.31)



**TO1616**

Upper Ball Joint  
(Ø15.31)



**TO1916**

Lower Ball Joint  
(Ø17.75)



**TO1916**

Lower Ball Joint  
(Ø17.75)



**LEFT**

**RIGHT**

**TOYOTA**

**HILUX**

**FRONT**

Year

YN50 / YN55 / YN51 / YN56 / YN58 / RN58 / LN51 / LN57

1984-1998

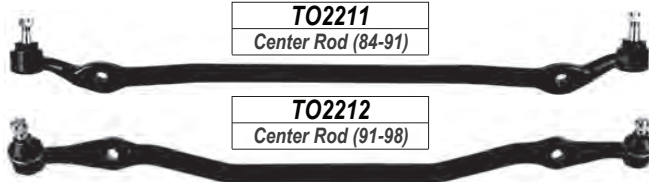

**TO2211**  
Center Rod (84-91)

**TO2212**  
Center Rod (91-98)

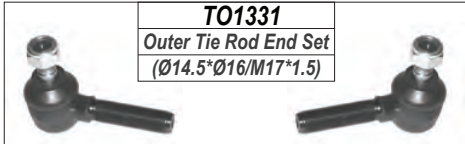

**TO1331**  
Outer Tie Rod End Set  
(Ø14.5\*Ø16/M17\*1.5)



**TO1333**  
Inner Tie Rod End Set  
(Ø14.5\*Ø16/M17\*1.5)

**TO1027**  
Outer Tie Rod End  
(Ø14.5\*Ø16/M17\*1.5)



**TO1112**  
Inner Tie Rod End  
(Ø14.5\*Ø16/M17\*1.5)



**TO1027**  
Outer Tie Rod End  
(Ø14.5\*Ø16/M17\*1.5)



**TO1210**  
Tie Rod Assembly



**CA1610**  
Upper Ball Joint  
(Ø17)



**CA1610**  
Upper Ball Joint  
(Ø17)



**CA1710**  
Upper Control Arm

**CA1710**  
Upper Control Arm

**CA1911**  
Lower Ball Joint  
(Ø18)(84-88)



**CA1911**  
Lower Ball Joint  
(Ø18)(84-88)

**CA2012**  
Lower Control Arm  
(84-88)

**CA2110**  
Lower Control Arm Bush

**CA2013**  
Lower Control Arm  
(84-88)

**TO1929**  
Lower Ball Joint  
(Ø18)(88-98)



**TO1929**  
Lower Ball Joint  
(Ø18)(88-98)

**TO2410**  
Idler Arm



**TO2046**  
Lower Control Arm  
(88-98)

**CA2110**  
Lower Control Arm Bush

**TO2047**  
Lower Control Arm  
(88-98)

**LEFT**

**RIGHT**

**TOYOTA**

**HILUX  
(STANDARD BODY)**

**FRONT**

**YN140 / RZN147 / LN140 / LN145**

*Year*

**1998-2005**



**TO2212**  
Center Rod

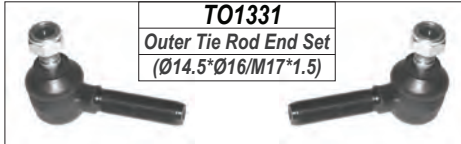

**TO1331**  
Outer Tie Rod End Set  
(Ø14.5\*Ø16/M17\*1.5)

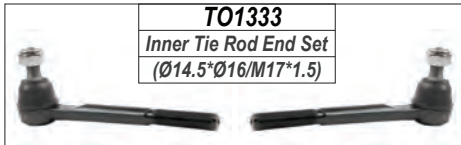

**TO1333**  
Inner Tie Rod End Set  
(Ø14.5\*Ø16/M17\*1.5)



**TO1334**  
Inner Tie Rod End Set  
(Ø14.5\*Ø16/M21\*1.5)

**TO1027**  
Outer Tie Rod End  
(Ø14.5\*Ø16/M17\*1.5)



**TO1112**  
Inner Tie Rod End  
(Ø14.5\*Ø16/M17\*1.5)



**TO1027**  
Outer Tie Rod End  
(Ø14.5\*Ø16/M17\*1.5)



**TO1113**  
Inner Tie Rod End  
(Ø14.5\*Ø16/M21\*1.5)

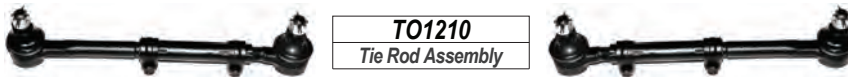

**TO1210**  
Tie Rod Assembly

**TO1617**  
Upper Ball Joint  
(Ø15)



**TO1718**  
Upper Control Arm



**TO1718**  
Upper Control Arm

**TO1617**  
Upper Ball Joint  
(Ø15)



**TO1929**  
Lower Ball Joint  
(Ø18)



**TO2046**  
Lower Control Arm



**CA2110**  
Lower Control Arm Bush



**TO2047**  
Lower Control Arm

**TO1929**  
Lower Ball Joint  
(Ø18)



**TO2411**  
Idler Arm



**TO2510**  
Pitman Arm(14mm pin)



**TO2511**  
Pitman Arm



**LEFT**

**RIGHT**

**TOYOTA**

**HILUX FRONT  
(RAISED BODY) (4X4)**

**RZN194 / LN192 / KZTE**

*Year*

**1998-2005**

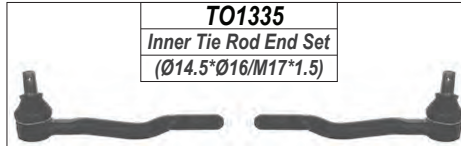
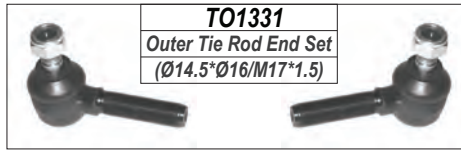

**TO1027**  
Outer Tie Rod End  
(Ø14.5\*Ø16/M17\*1.5)



**TO1114**  
Inner Tie Rod End  
(Ø14.5\*Ø16/M17\*1.5)



**TO1027**  
Outer Tie Rod End  
(Ø14.5\*Ø16/M17\*1.5)



**TO1535**  
Link Stabilizer  
L=151

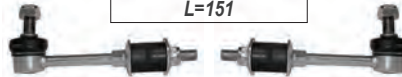

**TO1618**  
Upper Ball Joint  
(Ø16.75)



**TO1719**  
Upper Control Arm



**TO1720**  
Upper Control Arm



**TO1618**  
Upper Ball Joint  
(Ø16.75)

**TO1930**  
Lower Ball Joint  
(Ø18)



**TO2048**  
Lower Control Arm



**TO2049**  
Lower Control Arm



**TO1930**  
Lower Ball Joint  
(Ø18)

**TO2412**  
Idler Arm



**TO2511**  
Pitman Arm



**LEFT**

**RIGHT**



**TOYOTA**

**HILUX FRONT  
(STANDARD BODY)**

**ALL MODELS**

*Year*

**2005-2016**

**TO1041**  
Outer Tie Rod End  
(Ø13.5\*Ø16/M15\*1.5)

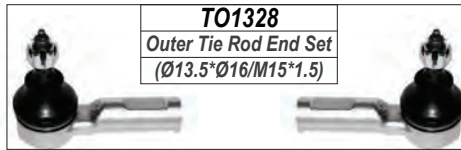

**TO1328**  
Outer Tie Rod End Set  
(Ø13.5\*Ø16/M15\*1.5)

**TO1041**  
Outer Tie Rod End  
(Ø13.5\*Ø16/M15\*1.5)



**TO1424**  
Rack End  
(14\*1.5/15\*1.5/294)

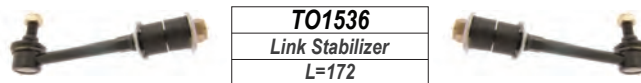

**TO1536**  
Link Stabilizer  
L=172

**TO1613**  
Upper Ball Joint  
(Ø15)



**TO1811**  
Upper Control Arm Bush

**TO1721**  
Upper Control Arm

**TO1722**  
Upper Control Arm

**TO1613**  
Upper Ball Joint  
(Ø15)



**TO1915**  
Lower Ball Joint  
(Ø16.7)



**TO2123**  
Lower Control Arm Bush

**TO2050**  
Lower Control Arm

**TO2051**  
Lower Control Arm

**TO1915**  
Lower Ball Joint  
(Ø16.7)



**TO2822**  
Shock Mounting



**TO2124**  
Lower Control Arm Bush

**TO2822**  
Shock Mounting



**TO2823**  
Shock Mounting



**TO2823**  
Shock Mounting



**LEFT**

**RIGHT**



**TOYOTA**

**HILUX  
(RAISED BODY)**

**FRONT**

**ALL MODELS**

*Year*

**2005-2016**

**TO1042**  
Outer Tie Rod End  
(Ø15.3\*Ø17.1/M15\*1.5)

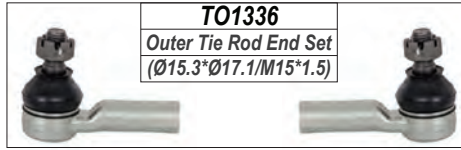

**TO1336**  
Outer Tie Rod End Set  
(Ø15.3\*Ø17.1/M15\*1.5)

**TO1424**  
Rack End  
(14\*1.5/15\*1.5/294)

**TO1042**  
Outer Tie Rod End  
(Ø15.3\*Ø17.1/M15\*1.5)

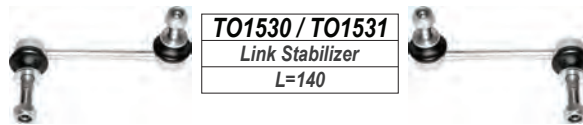

**TO1530 / TO1531**  
Link Stabilizer  
L=140

**TO1613**  
Upper Ball Joint  
(Ø15)



**TO1811**  
Upper Control Arm Bush

**TO1716**  
Upper Control Arm

**TO1717**  
Upper Control Arm

**TO1613**  
Upper Ball Joint  
(Ø15)



**TO2121**  
Lower Control Arm Bush

**TO1915**  
Lower Ball Joint  
(Ø16.7)



**TO2044**  
Lower Control Arm

**TO2045**  
Lower Control Arm

**TO1915**  
Lower Ball Joint  
(Ø16.7)



**TO2822**  
Shock Mounting



**TO2122**  
Lower Control Arm Bush

**TO2822**  
Shock Mounting



**TO2823**  
Shock Mounting



**TO2823**  
Shock Mounting



**LEFT**

**RIGHT**

**TOYOTA**

**HILUX FRONT  
(STANDARD BODY 4X2)**

**ALL MODELS**

Year

**2016-**

**TO1028**  
Outer Tie Rod End  
(Ø15.3\*Ø17.1/M16\*1.5)

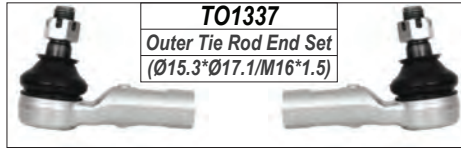

**TO1337**  
Outer Tie Rod End Set  
(Ø15.3\*Ø17.1/M16\*1.5)

**TO1425**  
Rack End  
(14\*1.5/16\*1.5/296)

**TO1028**  
Outer Tie Rod End  
(Ø15.3\*Ø17.1/M16\*1.5)



**TO1530 / TO1531**  
Link Stabilizer  
L=140



**TO1613**  
Upper Ball Joint  
(Ø15)



**TO1811**  
Upper Control Arm Bush



**TO1613**  
Upper Ball Joint  
(Ø15)



**TO1721**  
Upper Control Arm

**TO1722**  
Upper Control Arm

**TO1915**  
Lower Ball Joint  
(Ø16.7)



**TO2123**  
Lower Control Arm Bush



**TO1915**  
Lower Ball Joint  
(Ø16.7)



**TO2050**  
Lower Control Arm

**TO2051**  
Lower Control Arm

**TO2124**  
Lower Control Arm Bush

**LEFT**

**RIGHT**

**TOYOTA**

**HILUX FRONT  
(RAISED BODY 4X2) (4X4)**

**ALL MODELS**

*Year*

**2016-**

**TO1028**  
Outer Tie Rod End  
(Ø15.3\*Ø17.1/M16\*1.5)

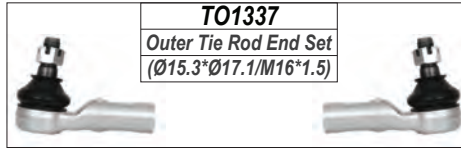

**TO1337**  
Outer Tie Rod End Set  
(Ø15.3\*Ø17.1/M16\*1.5)

**TO1425**  
Rack End  
(14\*1.5/16\*1.5/296)

**TO1028**  
Outer Tie Rod End  
(Ø15.3\*Ø17.1/M16\*1.5)



**TO1530 / TO1531**  
Link Stabilizer  
L=140



**TO1613**  
Upper Ball Joint  
(Ø15)



**TO1716**  
Upper Control Arm

**TO1717**  
Upper Control Arm

**TO1811**  
Upper Control Arm Bush



**TO1613**  
Upper Ball Joint  
(Ø15)



**TO1915**  
Lower Ball Joint  
(Ø16.7)



**TO2052**  
Lower Control Arm

**TO2053**  
Lower Control Arm

**TO1915**  
Lower Ball Joint  
(Ø16.7)



**LEFT**

**RIGHT**

**TOYOTA**

**LAND CRUISER  
(4WD)**

**FRONT**

**ALL MODELS**

*Year*

**1985-**

**TO1044**

*Outer Tie Rod End*  
(Ø14.7\*Ø16/M23\*1.5)



**TO1045**

*Outer Tie Rod End*  
(Ø14.7\*Ø16/M23\*1.5)



**TO1043**

*Outer Tie Rod End*  
(Ø14.65\*Ø16.4/M23\*1.5)



**TO1115**

*Inner Tie Rod End*  
(Ø14.65\*Ø16.4/M23\*1.5)



**LEFT**

**RIGHT**

**TOYOTA**

**LAND CRUISER  
(4WD)**

**FRONT**

**80 SERIES**

*Year*

**1990-1997**

**TO1044**

Outer Tie Rod End  
(Ø14.7\*Ø16/M23\*1.5)



**TO1426**

Rack End  
(18\*1.5/20\*1.5/132)



**TO1045**

Outer Tie Rod End  
(Ø14.7\*Ø16/M23\*1.5)



**TO1115**

Inner Tie Rod End  
(Ø14.65\*Ø16.4/M23\*1.5)



**TO1116**

Inner Tie Rod End  
(Ø14.7\*Ø16/M23\*1.5)



**TO1117**

Inner Tie Rod End  
(Ø14.7\*Ø16/M23\*1.5)



**TO1118**

Inner Tie Rod End  
(Ø14.7\*Ø16/M23\*1.5)



**TO1619**

Lower Ball Joint  
(Ø16.2)



**TO1619**

Lower Ball Joint  
(Ø16.2)



**TO1537 / TO1538**

Link Stabilizer  
L=62.5



**TO1931**

Lower Ball Joint  
(Ø17.5)



**TO1932**

Lower Ball Joint  
(Ø17.5)



**TO1539**

Link Stabilizer  
L=156



**LAND CRUISER**

**(4WD)**

**REAR**

**TO1540**

Link Stabilizer  
L=98



**LEFT**

**RIGHT**



**TOYOTA**

**LAND CRUISER  
PRADO (4WD)**

**FRONT**

**90 SERIES. 95 SERIES**

*Year*

**1996-2002**

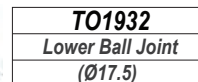
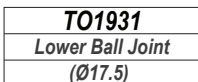
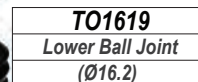
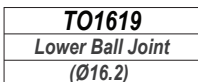
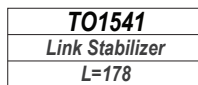
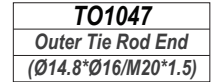
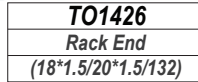
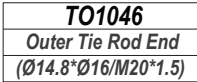

**LAND CRUISER  
(4WD)**

**REAR**

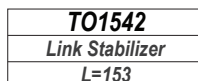

**LEFT**

**RIGHT**

**TOYOTA**

**LAND CRUISER  
(4WD)**

**FRONT**

**100 SERIES**

*Year*

**1998-2006**

**TO1048**  
Outer Tie Rod End  
(Ø18.3\*Ø20/M20\*1.5)

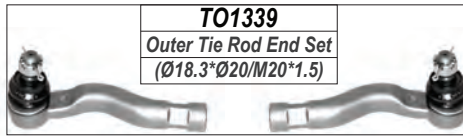

**TO1339**  
Outer Tie Rod End Set  
(Ø18.3\*Ø20/M20\*1.5)

**TO1427**  
Rack End  
(27\*1.5/20\*1.5/207)



**TO1049**  
Outer Tie Rod End  
(Ø18.3\*Ø20/M20\*1.5)



**TO1340**  
Outer Tie Rod End Set  
(Ø18.3\*Ø20/M20\*1.5)

**TO1050**  
Outer Tie Rod End  
(Ø18.3\*Ø20/M20\*1.5)



**TO1428**  
Rack End  
(18\*1.5/20\*1.5/197)



**TO1051**  
Outer Tie Rod End  
(Ø18.3\*Ø20/M20\*1.5)



**TO1543 / TO1544**  
Link Stabilizer  
L=115.5



**TO1610**  
Upper Ball Joint  
(Ø15.8)



**TO1610**  
Upper Ball Joint  
(Ø15.8)



**TO1725**  
Upper Control Arm

**TO1726**  
Upper Control Arm



**TO2056**  
Lower Control Arm



**TO2057**  
Lower Control Arm

**LEFT**

**RIGHT**

**TOYOTA**

**LAND CRUISER  
PRADO (4WD)**

**FRONT**

**120 SERIES**

*Year*

**2002-2009**

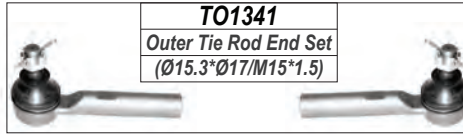

**TO1341**  
Outer Tie Rod End Set  
(Ø15.3\*Ø17/M15\*1.5)

**TO1052**  
Outer Tie Rod End  
(Ø15.3\*Ø17/M15\*1.5)



**TO1429**  
Rack End  
(22\*1.5/15\*1.5/260)



**TO1052**  
Outer Tie Rod End  
(Ø15.3\*Ø17/M15\*1.5)



**TO1530 / TO1531**  
Link Stabilizer  
L=140



**TO1610**  
Upper Ball Joint  
(Ø15.8)



**TO1810**  
Upper Control Arm Bush

**TO1610**  
Upper Ball Joint  
(Ø15.8)



**TO1714**  
Upper Control Arm

**TO1715**  
Upper Control Arm

**TO1928**  
Lower Ball Joint  
(Ø17.4)



**TO1928**  
Lower Ball Joint  
(Ø17.4)



**TO2042**  
Lower Control Arm

**TO2043**  
Lower Control Arm

**LAND CRUISER  
PRADO (4WD)**

**REAR**

**TO1545**  
Link Stabilizer  
L=173.5

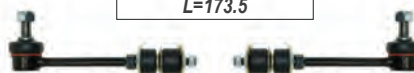

**LEFT**

**RIGHT**

**TOYOTA**

**LAND CRUISER  
PRADO**

**FRONT**

**150 SERIES**

*Year*

**2009-2015**

**TO1040**  
Outer Tie Rod End  
(Ø15.3\*Ø17/M16\*1.5)

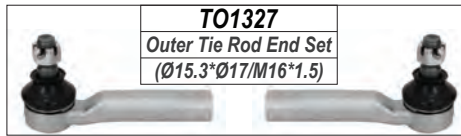

**TO1327**  
Outer Tie Rod End Set  
(Ø15.3\*Ø17/M16\*1.5)

**TO1430**  
Rack End  
(24\*1.5/16\*1.5/277)



**TO1040**  
Outer Tie Rod End  
(Ø15.3\*Ø17/M16\*1.5)



**TO1431**  
Rack End  
(28\*1.5/22\*1.5/234)



**TO1530 / TO1531**  
Link Stabilizer  
L=140

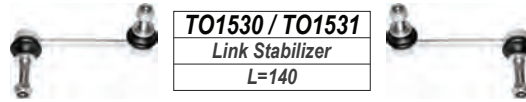

**TO1546 / TO1547**  
Link Stabilizer  
L=96

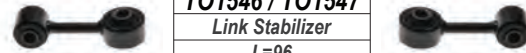

**TO1610**  
Upper Ball Joint  
(Ø15.8)



**TO1810**  
Upper Control Arm Bush

**TO1610**  
Upper Ball Joint  
(Ø15.8)



**TO1714**  
Upper Control Arm

**TO1715**  
Upper Control Arm

**TO1933**  
Lower Ball Joint  
(Ø17.4)



**TO2139**  
Lower Control Arm Bush

**TO2133**  
Lower Control Arm Bush

**TO1933**  
Lower Ball Joint  
(Ø17.4)



**TO2058**  
Lower Control Arm

**TO2059**  
Lower Control Arm

**LAND CRUISER  
PRADO**

**REAR**



**TO1545**  
Link Stabilizer  
L=173.5



**TO2610**  
Lateral Link

**LEFT**

**RIGHT**



**TOYOTA**

**LAND CRUISER**

**FRONT**

**200 SERIES**

*Year*

**2007-2017**

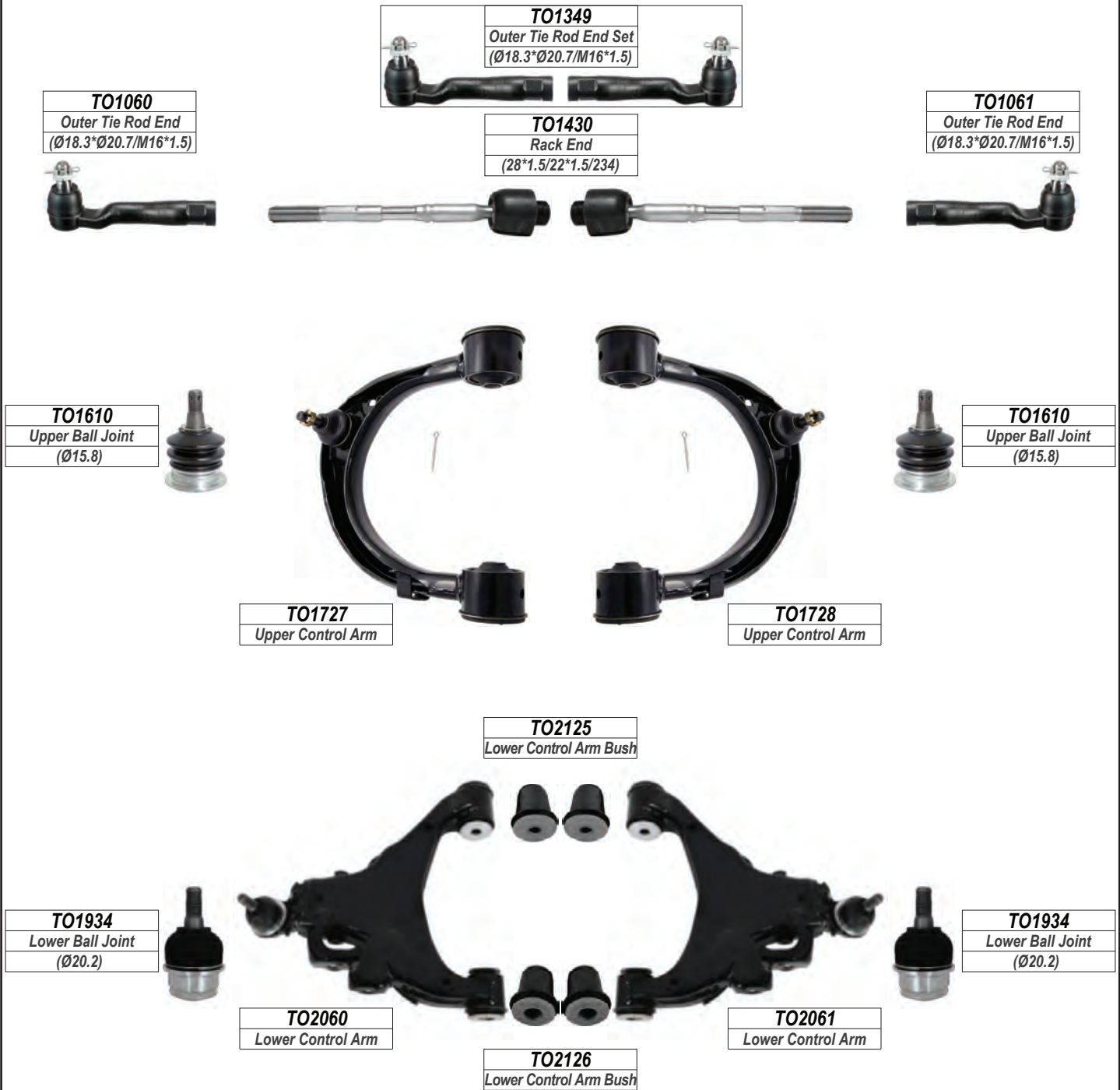

**LEFT**

**RIGHT**



**TOYOTA**

MR2

FRONT

ALL MODELS

Year

2001-

**TO1059**  
Outer Tie Rod End  
(Ø12.5\*Ø14/M12\*1.25)

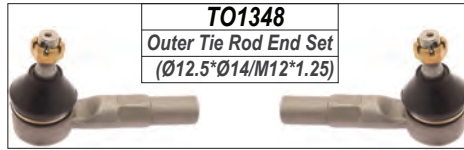

**TO1348**  
Outer Tie Rod End Set  
(Ø12.5\*Ø14/M12\*1.25)

**CA1411**  
Rack End  
(14\*1.5/12\*1.25/360)

**TO1059**  
Outer Tie Rod End  
(Ø12.5\*Ø14/M12\*1.25)



**TO1551**  
Link Stabilizer  
L=105



**TO1936**  
Lower Ball Joint  
(Ø13.5)



**TO2062**  
Lower Control Arm



**TO2063**  
Lower Control Arm

**TO1936**  
Lower Ball Joint  
(Ø13.5)



LEFT

RIGHT

**TOYOTA**

**QUANTUM**

**FRONT**

**ALL MODELS**

*Year*

**2005-**

**CM1010**  
Outer Tie Rod End  
(Ø14\*Ø17/M15\*1.5)

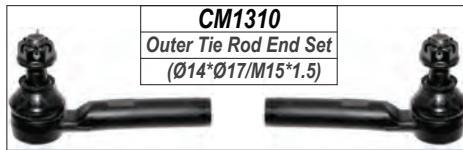

**CM1310**  
Outer Tie Rod End Set  
(Ø14\*Ø17/M15\*1.5)

**CM1010**  
Outer Tie Rod End  
(Ø14\*Ø17/M15\*1.5)



**CA1411**  
Rack End  
(14\*1.5/15\*1.5/274)



**CM1510**  
Link Stabilizer  
L=159.5



**CM1710**  
Upper Control Arm



**CM1711**  
Upper Control Arm

**TO2130**  
Lower Control Arm Bush



**CM1910**  
Lower Ball Joint  
(Ø17.25)



**CM2010**  
Lower Control Arm



**CM2011**  
Lower Control Arm

**CM1910**  
Lower Ball Joint  
(Ø17.25)



**LEFT**

**RIGHT**

**TOYOTA**

RAV4

FRONT

Year

1995-2000

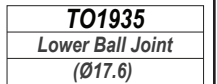
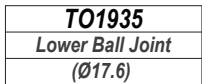
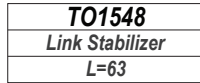
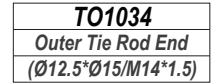
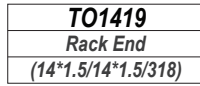
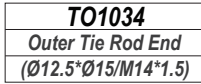
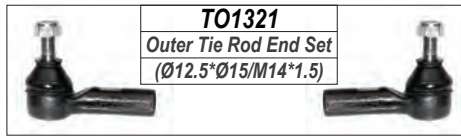

**LEFT**

**RIGHT**

**TOYOTA**

RAV4

FRONT

II

Year

2000-2006

**CY1011**  
Outer Tie Rod End  
(Ø12.5\*Ø15/M15\*1.5)

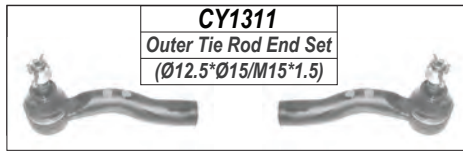

**CY1311**  
Outer Tie Rod End Set  
(Ø12.5\*Ø15/M15\*1.5)

**CY1012**  
Outer Tie Rod End  
(Ø12.5\*Ø15/M15\*1.5)



**CY1411**  
Rack End  
(14\*1.5/15\*1.5/298)

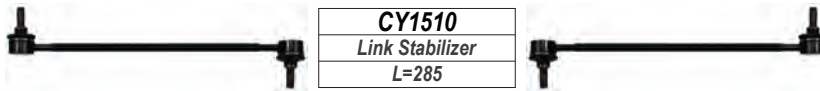

**CY1510**  
Link Stabilizer  
L=285

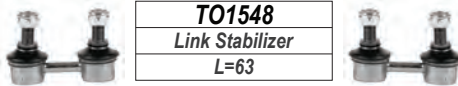

**TO1548**  
Link Stabilizer  
L=63

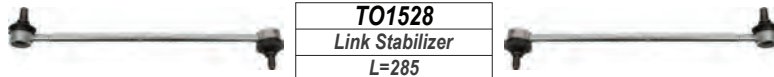

**TO1528**  
Link Stabilizer  
L=285

**CY1910**  
Lower Ball Joint  
(Ø15)



**CY1910**  
Lower Ball Joint  
(Ø15)



**CY2011**  
Lower Control Arm



**CY2012**  
Lower Control Arm

**TO2826**  
Shock Mounting



**TO2826**  
Shock Mounting



RAV4

REAR

**CY1511 / CY1512**  
Link Stabilizer  
L=100



LEFT

RIGHT

**TOYOTA**

RAV4

FRONT

III

Year

2006-2012

**TO1343**

Outer Tie Rod End Set  
(Ø13.6\*Ø16.1/M16\*1.5)



**TO1053**

Outer Tie Rod End  
(Ø13.6\*Ø16.1/M16\*1.5)



**TO1436**

Rack End  
(16\*1.5/16\*1.5/243)



**TO1054**

Outer Tie Rod End  
(Ø13.6\*Ø16.1/M16\*1.5)



**TO1511**

Link Stabilizer  
L=360



**TO1918**

Lower Ball Joint  
(Ø17.5)



**TO2066**

Lower Control Arm



**TO2067**

Lower Control Arm

**TO1918**

Lower Ball Joint  
(Ø17.5)



**TO2827**

Shock Mounting



**TO2828**

Shock Mounting



**TO2827**

Shock Mounting



**TO2828**

Shock Mounting



RAV4

REAR

**TO1549**

Link Stabilizer  
L=137.5



LEFT

RIGHT



**TOYOTA**

RAV4

FRONT

IV

Year

2006-2012

**TO1343**  
Outer Tie Rod End Set  
(Ø13.6\*Ø16.1/M16\*1.5)

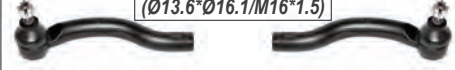

**TO1053**  
Outer Tie Rod End  
(Ø13.6\*Ø16.1/M16\*1.5)



**TO1054**  
Outer Tie Rod End  
(Ø13.6\*Ø16.1/M16\*1.5)



**TO1511**  
Link Stabilizer  
L=360



**TO1918**  
Lower Ball Joint  
(Ø17.5)



**TO1918**  
Lower Ball Joint  
(Ø17.5)



**TO2072**  
Lower Control Arm



**TO2073**  
Lower Control Arm



**TO2829**  
Shock Mounting



**TO2829**  
Shock Mounting



**LEFT**

**RIGHT**

**TOYOTA**

**STARLET**

**FRONT**

**ALL MODELS**

Year

**2020-**

**SZ1319**

Outer Tie Rod End Set  
(Ø12.9\*Ø14.9/M14\*1.5)

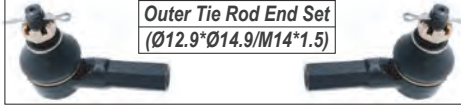

**SZ1021**

Outer Tie Rod End  
(Ø12.9\*Ø14.9/M14\*1.5)



**SZ1417**

Rack End  
(14\*1.5/14\*1.5/323)



**SZ1022**

Outer Tie Rod End  
(Ø12.9\*Ø14.9/M14\*1.5)



**SZ1517**

Link Stabilizer  
L=350



**SZ2114**

Lower Control Arm Bush



**SZ1913**

Lower Ball Joint  
(Ø13.5)



**SZ1913**

Lower Ball Joint  
(Ø13.5)



**SZ2024**

Lower Control Arm

**SZ2025**

Lower Control Arm

**SZ2115**

Lower Control Arm Bush



**LEFT**

**RIGHT**

**TOYOTA**

**YARIS**

**FRONT**

**ALL MODELS**

*Year*

**2005-**

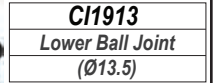
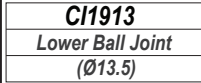
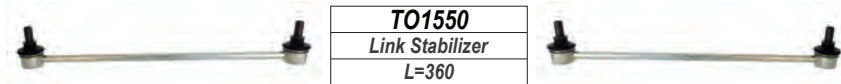
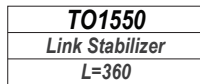
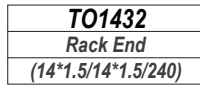
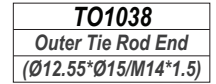
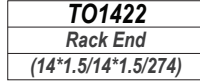
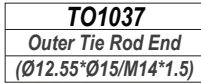
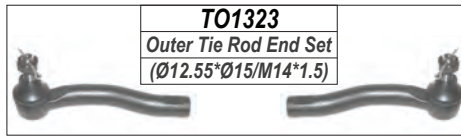

**LEFT**

**RIGHT**

**VOLKSWAGEN**

**AMAROK**

**FRONT**

**ALL MODELS**

*Year*

**2010-**

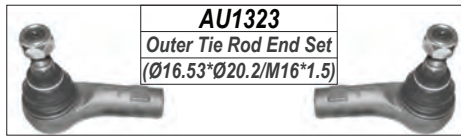

**AU1323**  
Outer Tie Rod End Set  
(Ø16.53\*Ø20.2/M16\*1.5)

**AU1035**  
Outer Tie Rod End  
(Ø16.53\*Ø20.2/M16\*1.5)



**AU1419**  
Rack End  
(16\*1.5 /16\*1.5/291)



**AU1036**  
Outer Tie Rod End  
(Ø16.53\*Ø20.2/M16\*1.5)



**VW1510**  
Link Stabilizer  
L=145



**VW1511**  
Link Stabilizer  
L=146



**VW1610**  
Upper Ball Joint  
(Ø15.75)



**VW1810**  
Upper Control Arm Bush



**VW1610**  
Upper Ball Joint  
(Ø15.75)

**VW1710**  
Upper Control Arm

**VW1711**  
Upper Control Arm

**VW2111**  
Lower Control Arm Bush

**VW2110**  
Lower Control Arm Bush

**VW2111**  
Lower Control Arm Bush

**VW1910**  
Lower Ball Joint  
(Ø20.7)



**VW2010**  
Lower Control Arm

**VW2011**  
Lower Control Arm

**VW1910**  
Lower Ball Joint  
(Ø20.7)



**VW2820**  
Shock Mounting



**VW2112**  
Lower Control Arm Bush

**VW2810**  
Stabilizer Bar Bush



**VW2820**  
Shock Mounting



**LEFT**

**RIGHT**

**VOLKSWAGEN**

**BEETLE**

**FRONT**

**ALL MODELS**

*Year*

**1999-2010**

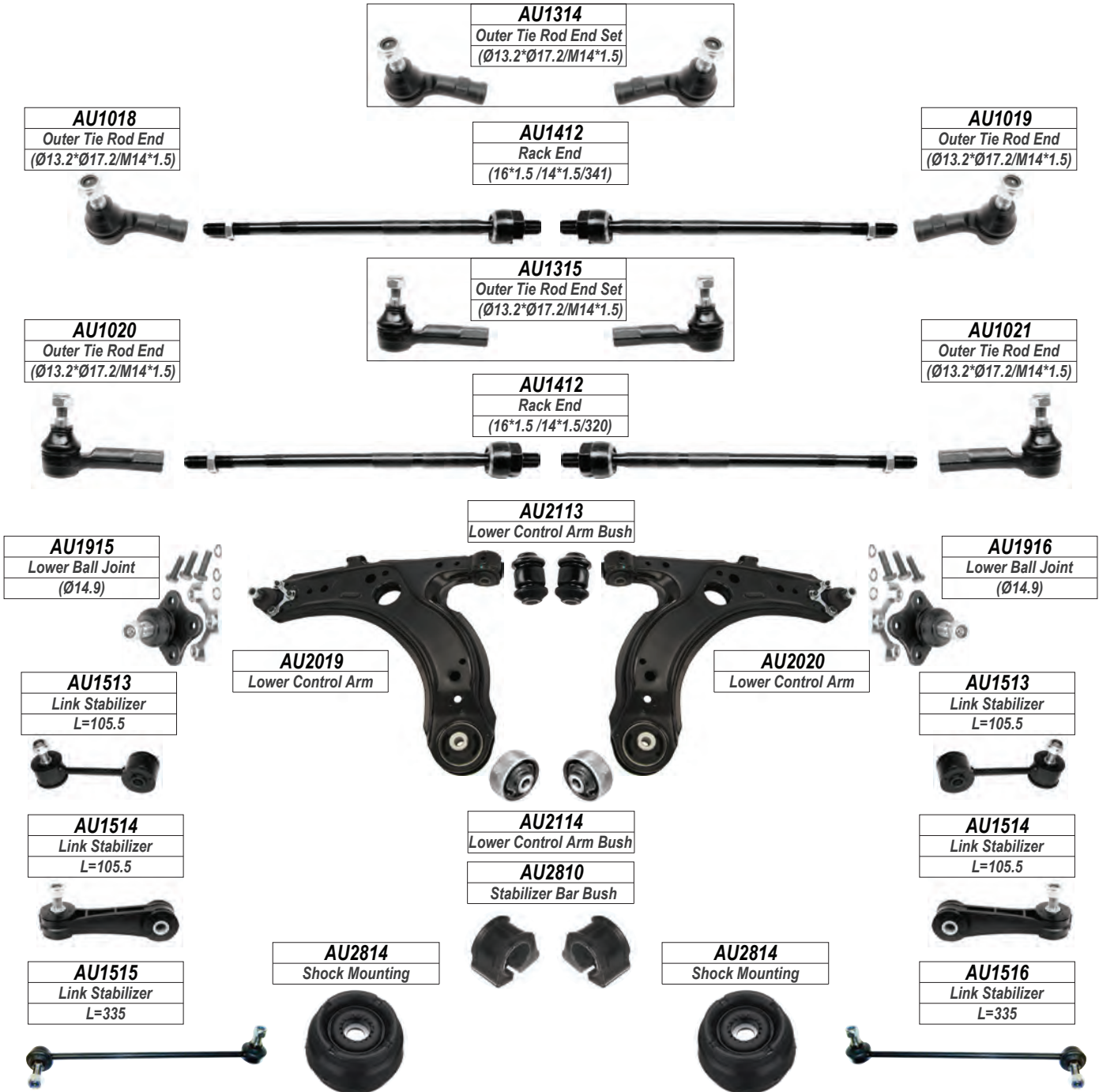

**BEETLE**

**REAR**



**LEFT**

**RIGHT**



**VOLKSWAGEN**

BEETLE

FRONT

ALL MODELS

Year

2011-

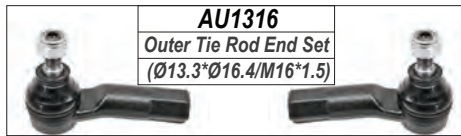

**AU1316**  
Outer Tie Rod End Set  
(Ø13.3\*Ø16.4/M16\*1.5)

**AU1030**  
Outer Tie Rod End  
(Ø13.3\*Ø16.4/M16\*1.5)

**AU1031**  
Outer Tie Rod End  
(Ø13.3\*Ø16.4/M16\*1.5)

**VW1413**  
Rack End  
(16\*1.5/16\*1.5/329)



**AU1518**  
Link Stabilizer  
L=335



**AU2115**  
Lower Control Arm Bush

**AU1917**  
Lower Ball Joint  
(Ø15.4)

**AU1918**  
Lower Ball Joint  
(Ø15.4)



**AU2817**  
Shock Mounting

**VW2012**  
Lower Control Arm

**VW2013**  
Lower Control Arm

**AU2817**  
Shock Mounting



**VW2113**  
Lower Control Arm Bush



BEETLE

REAR

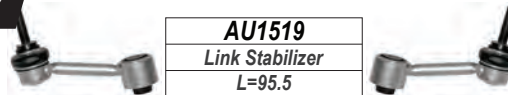

**AU1519**  
Link Stabilizer  
L=95.5

**AU2915**  
Bush  
(ID: Ø14.3/OD: Ø24.3)

**VW2911**  
Bush

**VW2911**  
Bush



**AU2610**  
Lateral Link

**AU2610**  
Lateral Link



**AU1710**  
Upper Control Arm



**VW2114**  
Lower Control Arm Bush



**VW2014**  
Lower Control Arm

**VW2014**  
Lower Control Arm



**AU2080 / AU2081**  
Lower Control Arm

LEFT

RIGHT

**VOLKSWAGEN**

**CADDY I**

**FRONT**

**LDV**

*Year*

**1981-2003**

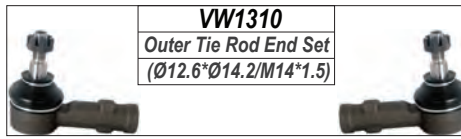

**VW1310**  
Outer Tie Rod End Set  
(Ø12.6\*Ø14.2/M14\*1.5)

**VW1012**  
Outer Tie Rod End  
(Ø12.6\*Ø14.2/M14\*1.5)

**VW1414**  
Rack End  
(22\*1.5 /14\*1.5/341)

**VW1012**  
Outer Tie Rod End  
(Ø12.6\*Ø14.2/M14\*1.5)



**VW1512**  
Link Stabilizer  
L=75



**VW2115**  
Lower Control Arm Bush

**VW1911**  
Lower Ball Joint  
(Ø17)



**VW2015**  
Lower Control Arm

**VW2016**  
Lower Control Arm

**VW1911**  
Lower Ball Joint  
(Ø17)



**VW2821**  
Shock Mounting



**VW2116**  
Lower Control Arm Bush

**VW2821**  
Shock Mounting



**LEFT**

**RIGHT**

**VOLKSWAGEN**
**CADDY III**
**FRONT**
**ALL MODELS**

Year

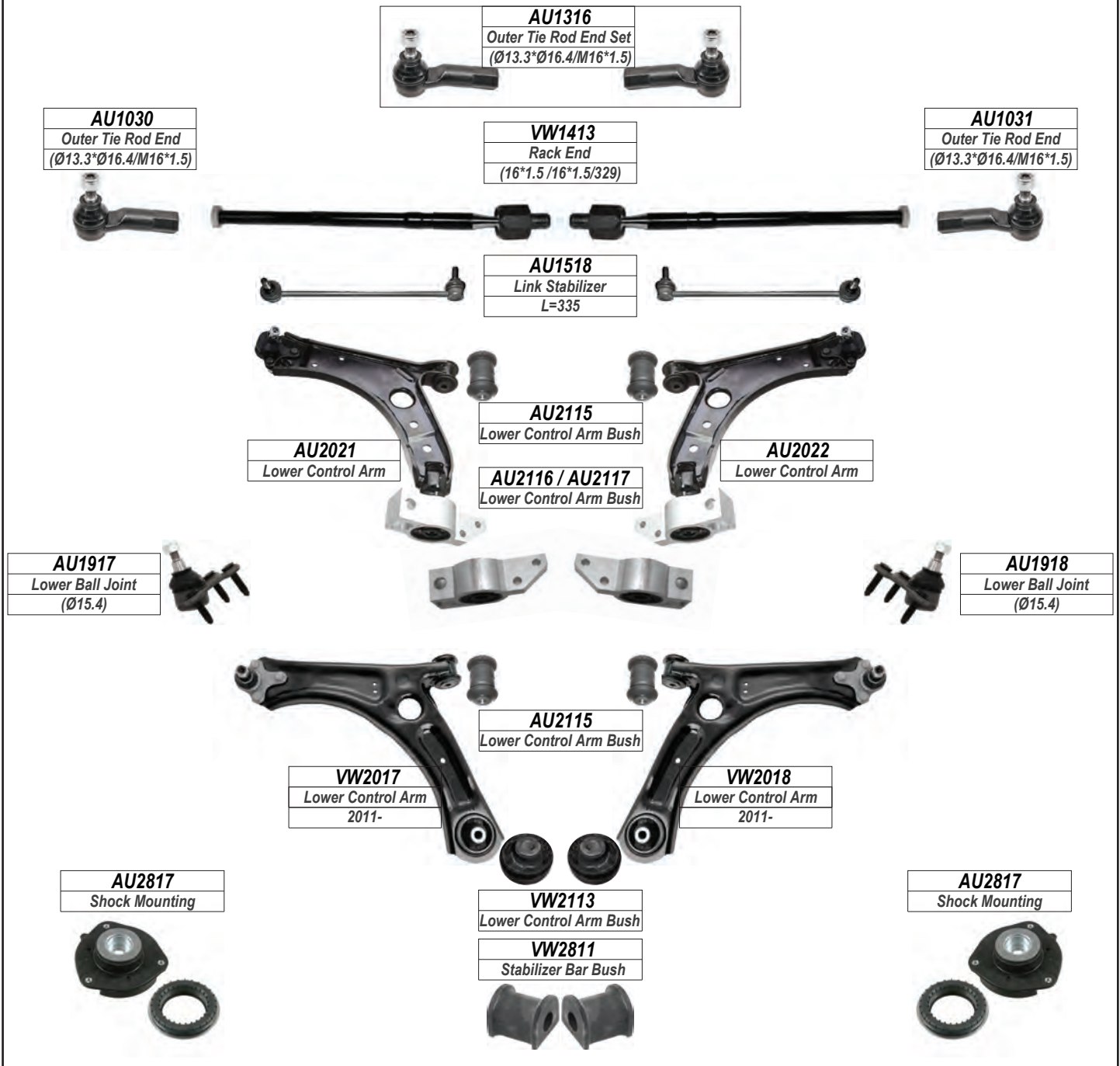
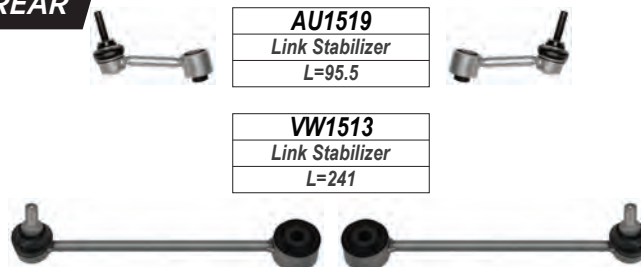
**2004-2015**

**CADDY III**
**REAR**

**LEFT**
**RIGHT**

**VOLKSWAGEN**

CC

FRONT

ALL MODELS

Year

2011-

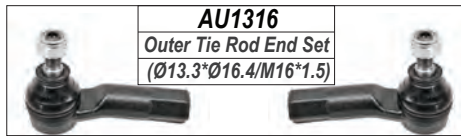

**AU1316**  
Outer Tie Rod End Set  
(Ø13.3\*Ø16.4/M16\*1.5)

**AU1030**  
Outer Tie Rod End  
(Ø13.3\*Ø16.4/M16\*1.5)

**VW1413**  
Rack End  
(16\*1.5 /16\*1.5/329)

**AU1031**  
Outer Tie Rod End  
(Ø13.3\*Ø16.4/M16\*1.5)

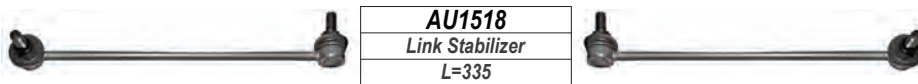

**AU1518**  
Link Stabilizer  
L=335

**VW1912**  
Lower Ball Joint  
(Ø15.3)

**AU2115**  
Lower Control Arm Bush

**VW1913**  
Lower Ball Joint  
(Ø15.3)



**VW2019**  
Lower Control Arm

**VW2020**  
Lower Control Arm

**AU2817**  
Shock Mounting

**AU2817**  
Shock Mounting



**AU2134**  
Lower Control Arm Bush

CC REAR

**AU2915**  
Bush  
(ID: Ø14.3/OD: Ø24.3)

**VW2911**  
Bush

**VW2911**  
Bush



**AU2610**  
Lateral Link

**AU2610**  
Lateral Link



**AU1519**  
Link Stabilizer  
L=95.5

**AU1710**  
Upper Control Arm

**AU1519**  
Link Stabilizer  
L=95.5

**VW2114**  
Lower Control Arm Bush



**VW2014**  
Lower Control Arm

**VW2014**  
Lower Control Arm



**AU2080 / AU2081**  
Lower Control Arm

LEFT

RIGHT



**VOLKSWAGEN**

**CRAFTER**

**FRONT**

**ALL MODELS**

*Year*

**2006-**

**ME1051**  
Outer Tie Rod End  
(Ø16.85\*Ø21/M16\*1.5)

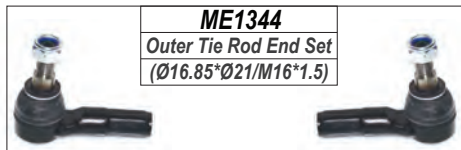

**ME1344**  
Outer Tie Rod End Set  
(Ø16.85\*Ø21/M16\*1.5)

**ME1422**  
Rack End  
(18\*1.5/16\*1.5/401)



**ME1051**  
Outer Tie Rod End  
(Ø16.85\*Ø21/M16\*1.5)



**ME1584 / ME1585**  
Link Stabilizer  
L=137.5

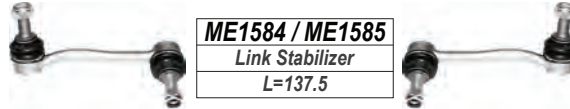

**ME2148**  
Lower Control Arm Bush



**ME1931**  
Lower Ball Joint  
(Ø21.8)



**ME1931**  
Lower Ball Joint  
(Ø21.8)



**ME2079**  
Lower Control Arm

**ME2080**  
Lower Control Arm

**ME2149**  
Lower Control Arm Bush

**ME2822**  
Stabilizer Bar Bush  
ID:24 W:45



**ME2823**  
Stabilizer Bar Bush  
ID:20 W:45



**ME2959**  
Stabilizer Bar Bush  
ID:20 W:52.5



**ME2960**  
Stabilizer Bar Bush  
ID:15.5 W:52.5



**ME2825**  
Shock Mounting



**ME2825**  
Shock Mounting



**CRAFTER**

**REAR**

**ME2955**  
Bush



**ME1586**  
Link Stabilizer  
L=212

**ME1586**  
Link Stabilizer  
L=212



**ME2824**  
Stabilizer Bar Bush

**LEFT**

**RIGHT**



**VOLKSWAGEN**

EOS

FRONT

ALL MODELS

Year

2007-

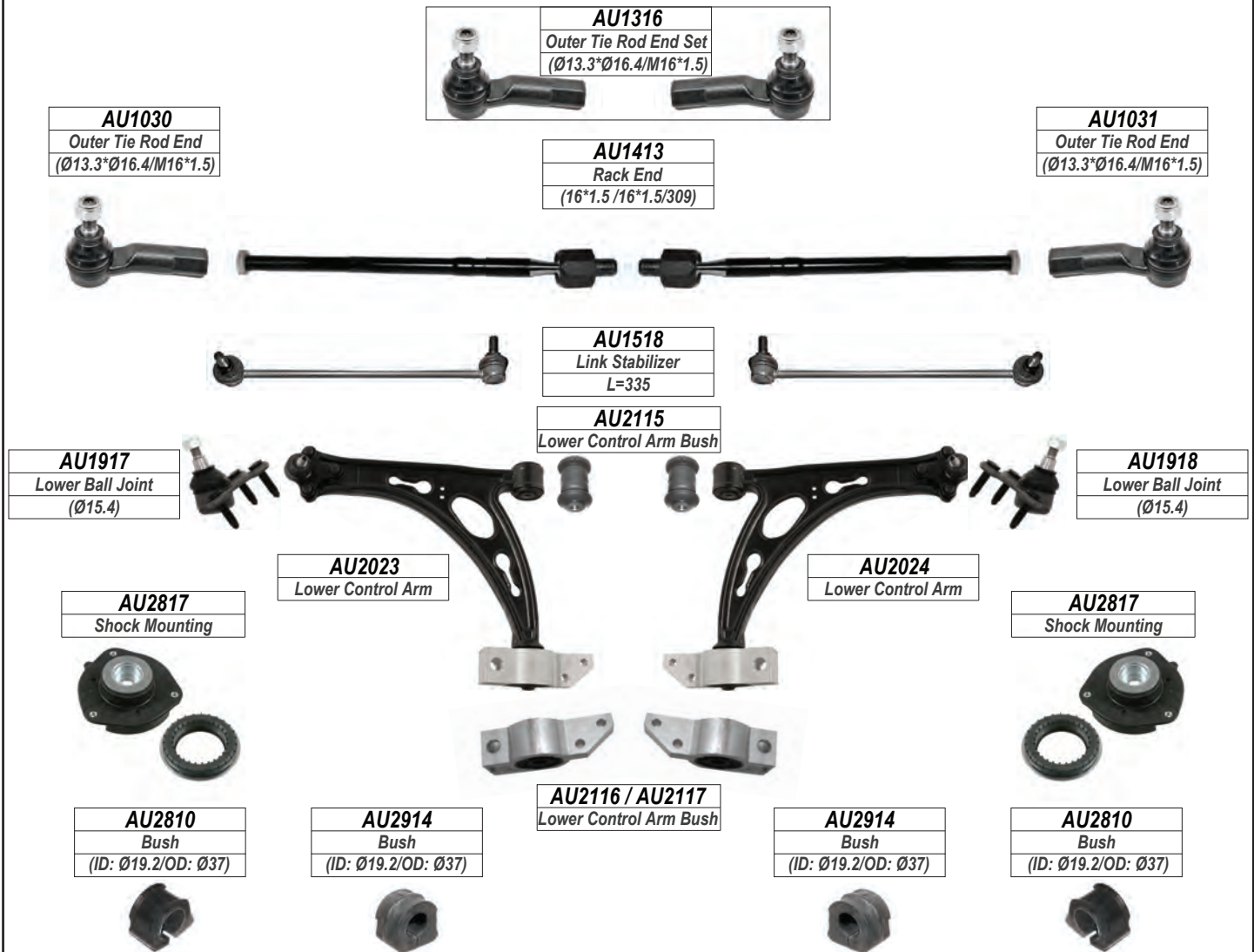

EOS

REAR



LEFT

RIGHT

**VOLKSWAGEN**

**GOLF I / CITY GOLF FRONT  
FOX**

**ALL MODELS**

Year

1974-2009

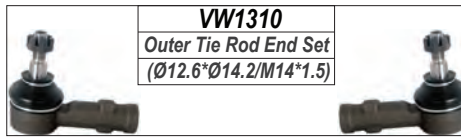

**VW1310**  
Outer Tie Rod End Set  
(Ø12.6\*Ø14.2/M14\*1.5)

**VW1012**  
Outer Tie Rod End  
(Ø12.6\*Ø14.2/M14\*1.5)

**VW1414**  
Rack End  
(22\*1.5 /14\*1.5/341)

**VW1012**  
Outer Tie Rod End  
(Ø12.6\*Ø14.2/M14\*1.5)



**VW1512**  
Link Stabilizer  
L=75



**VW1911**  
Lower Ball Joint  
(Ø17)



**VW1911**  
Lower Ball Joint  
(Ø17)



**VW1914**  
Lower Ball Joint  
(Ø15)



**VW2115**  
Lower Control Arm Bush



**VW2015**  
Lower Control Arm

**VW2016**  
Lower Control Arm

**VW1914**  
Lower Ball Joint  
(Ø15)



**VW2821**  
Shock Mounting



**VW2116**  
Lower Control Arm Bush



**VW2821**  
Shock Mounting



**GOLF I / CITY GOLF REAR  
FOX**

**VW2823**  
Shock Mounting  
ID:18 H:84



**VW2823**  
Shock Mounting  
ID:18 OD:29



**VW2824**  
Shock Mounting  
ID:31 H:38



**VW2824**  
Shock Mounting  
ID:31 H:38



**LEFT**

**RIGHT**

**VOLKSWAGEN**

**GOLF II**

**FRONT**

**ALL MODELS**

*Year*

**1984-1992**

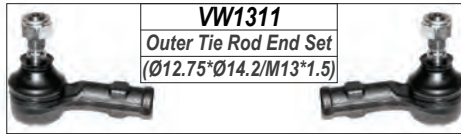

**VW1311**  
Outer Tie Rod End Set  
(Ø12.75\*Ø14.2/M13\*1.5)

**VW1013**  
Outer Tie Rod End  
(Ø12.75\*Ø14.2/M13\*1.5)

**VW1415**  
Rack End  
(22\*1.5/14\*1.5/328)(M/S)

**VW1014**  
Outer Tie Rod End  
(Ø12.75\*Ø14.2/M13\*1.5)



**VW1416**  
Rack End  
(14\*1.5/14\*1.5/340)(P/S)



**VW1512**  
Link Stabilizer  
L=75

**VW1915**  
Lower Ball Joint  
(Ø17)



**VW2021**  
Lower Control Arm

**AU2113**  
Lower Control Arm Bush

**VW2022**  
Lower Control Arm



**VW1915**  
Lower Ball Joint  
(Ø17)

**VW2117**  
Lower Control Arm Bush

**VW1926**  
Lower Ball Joint  
(Ø19)



**VW2023**  
Lower Control Arm

**AU2113**  
Lower Control Arm Bush

**VW2024**  
Lower Control Arm



**VW1926**  
Lower Ball Joint  
(Ø19)

**VW2117**  
Lower Control Arm Bush

**VW1916**  
Lower Ball Joint  
(Ø19)



**VW1916**  
Lower Ball Joint  
(Ø19)

**VW2822**  
Shock Mounting



**VW2813**  
Stabilizer Bar Bush  
ID:17 OD:35



**VW2814**  
Stabilizer Bar Bush  
ID:19 OD:37



**VW2822**  
Shock Mounting



**GOLF II**

**REAR**

**VW2823**  
Shock Mounting  
ID:18 H:84



**VW2824**  
Shock Mounting  
ID:31 H:38



**VW2914**  
Bush



**VW2824**  
Shock Mounting  
ID:31 H:38



**VW2823**  
Shock Mounting  
ID:18 OD:29



**LEFT**

**RIGHT**



**VOLKSWAGEN**  
**GOLF III FRONT**

**ALL MODELS**

Year

1992-1999

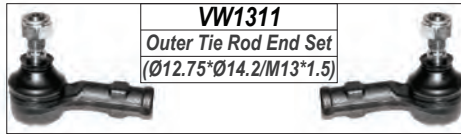

**VW1311**  
Outer Tie Rod End Set  
(Ø12.75\*Ø14.2/M13\*1.5)

**VW1013**  
Outer Tie Rod End  
(Ø12.75\*Ø14.2/M13\*1.5)

**VW1417**  
Rack End  
(22\*1.5/14\*1.5/381)(M/S)

**VW1014**  
Outer Tie Rod End  
(Ø12.75\*Ø14.2/M13\*1.5)



**VW1418**  
Rack End  
(14\*1.5/14\*1.5/369)(P/S)



**VW1512**  
Link Stabilizer  
L=75



**AU2914**  
Stabilizer Bar Bush  
(ID: Ø19.2/OD: Ø37)

**AU2810**  
Bush  
(ID: Ø19.2/OD: Ø37)

**VW2814**  
Stabilizer Bar Bush  
ID:19 OD:37



**VW1512**  
Link Stabilizer  
L=75

**VW1514**  
Link Stabilizer  
L=51



**VW1514**  
Link Stabilizer  
L=51

**VW1515**  
Link Stabilizer  
L=78



**VW1515**  
Link Stabilizer  
L=78

**VW1926**  
Lower Ball Joint  
(Ø19)



**AU2113**  
Lower Control Arm Bush



**VW1926**  
Lower Ball Joint  
(Ø19)

**VW1916**  
Lower Ball Joint  
(Ø19)



**VW2050**  
Lower Control Arm



**VW2117**  
Lower Control Arm Bush



**VW2051**  
Lower Control Arm



**VW1916**  
Lower Ball Joint  
(Ø19)

**VW1917**  
Lower Ball Joint  
(Ø16.5)(VR6 Only)



**VW2026**  
Lower Control Arm  
VR6 Only

**AU2113**  
Lower Control Arm Bush



**VW2027**  
Lower Control Arm  
VR6 Only



**VW1917**  
Lower Ball Joint  
(Ø16.5)(VR6 Only)

**VW2825**  
Shock Mounting



**VW2825**  
Shock Mounting



**VW2117**  
Lower Control Arm Bush

**GOLF III REAR**

**VW2823**  
Shock Mounting  
ID:18 H:84



**VW2824**  
Shock Mounting  
ID:31 H:38



**VW2914**  
Bush



**VW2824**  
Shock Mounting  
ID:31 H:38



**VW2823**  
Shock Mounting  
ID:18 OD:29



LEFT

RIGHT

**VOLKSWAGEN**

**GOLF IV**

**FRONT**

**ALL MODELS**

*Year*

**1999-2004**

**AU1314**  
Outer Tie Rod End Set  
(Ø13.2\*Ø17.2/M14\*1.5)

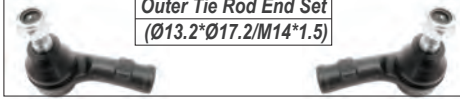

**AU1018**  
Outer Tie Rod End  
(Ø13.2\*Ø17.2/M14\*1.5)



**AU1412**  
Rack End  
(16\*1.5 /14\*1.5/341)



**AU1019**  
Outer Tie Rod End  
(Ø13.2\*Ø17.2/M14\*1.5)



**AU1315**  
Outer Tie Rod End Set  
(Ø13.2\*Ø17.2/M14\*1.5)

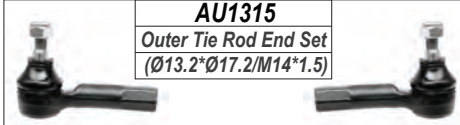

**AU1020**  
Outer Tie Rod End  
(Ø13.2\*Ø17.2/M14\*1.5)



**AU1411**  
Rack End  
(16\*1.5 /14\*1.5/320)



**AU1021**  
Outer Tie Rod End  
(Ø13.2\*Ø17.2/M14\*1.5)



**AU2113**  
Lower Control Arm Bush



**AU1915**  
Lower Ball Joint  
(Ø14.9)

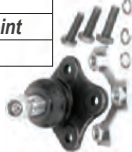

**AU1916**  
Lower Ball Joint  
(Ø14.9)

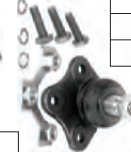

**AU2019**  
Lower Control Arm

**AU2020**  
Lower Control Arm

**AU1513**  
Link Stabilizer  
L=105.5



**AU1513**  
Link Stabilizer  
L=105.5



**AU2114**  
Lower Control Arm Bush



**AU1514**  
Link Stabilizer  
L=105.5



**AU1514**  
Link Stabilizer  
L=105.5



**AU1545**  
Link Stabilizer  
L=335



**AU2810**  
Stabilizer Bar Bush



**AU1546**  
Link Stabilizer  
L=335



**AU2814**  
Shock Mounting



**AU2814**  
Shock Mounting



**LEFT**

**RIGHT**



**VOLKSWAGEN**

**GOLF IV**

**REAR**

**ALL MODELS**

*Year*

**1999-2004**

**AU1517**  
Link Stabilizer  
L=175



**VW2910**  
Bush

**VW2910**  
Bush



**VW2610**  
Lateral Link



**VW2610**  
Lateral Link



**VW2611**  
Lateral Link



**VW2611**  
Lateral Link

**AU2913**  
Bush  
(ID: Ø12.2/OD: Ø50)



**AU2912**  
Bush  
(ID: Ø12.2/OD: Ø71.5)



**AU2815**  
Shock Mounting



**AU2815**  
Shock Mounting



**LEFT**

**RIGHT**

**VOLKSWAGEN**

GOLF V / VI

FRONT

ALL MODELS

Year

2004-2012

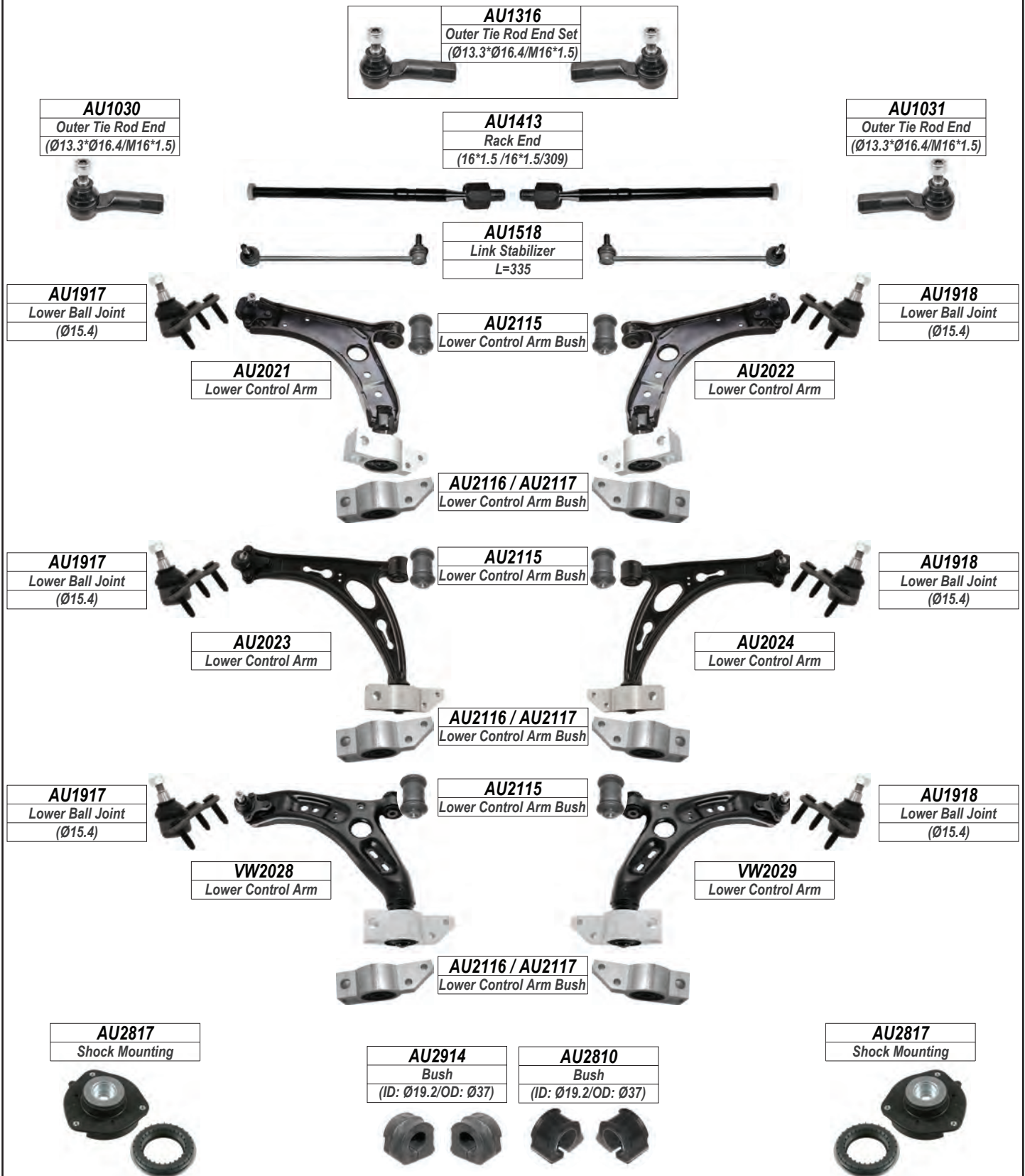

LEFT

RIGHT

**VOLKSWAGEN**

GOLF V / VI

REAR

ALL MODELS

Year

2004-2012

**AU1519**  
Link Stabilizer  
L=95.5



**AU2915**  
Bush  
(ID: Ø14.3/OD: Ø24.3)



**VW2911**  
Bush



**VW2911**  
Bush

**AU2610**  
Lateral Link

**AU2610**  
Lateral Link

**AU1710**  
Upper Control Arm



**AU2080 / AU2081**  
Lower Control Arm



**VW2114**  
Lower Control Arm Bush



**VW2014**  
Lower Control Arm



**VW2014**  
Lower Control Arm



**AU2818**  
Shock Mounting



**AU2818**  
Shock Mounting



LEFT

RIGHT

**VOLKSWAGEN**

**GOLF VII**

**FRONT**

**ALL MODELS**

**Year**

**2012-**

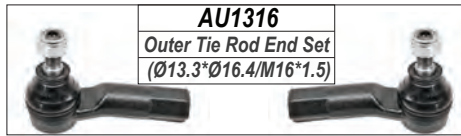

**AU1316**  
Outer Tie Rod End Set  
(Ø13.3\*Ø16.4/M16\*1.5)

**AU1030**  
Outer Tie Rod End  
(Ø13.3\*Ø16.4/M16\*1.5)

**AU1413**  
Rack End  
(16\*1.5 /16\*1.5/309)

**AU1031**  
Outer Tie Rod End  
(Ø13.3\*Ø16.4/M16\*1.5)



**AU1520**  
Link Stabilizer  
L=335



**AU2115**  
Lower Control Arm Bush

**VW1924**  
Lower Ball Joint  
(Ø15.4)



**VW1925**  
Lower Ball Joint  
(Ø15.4)

**AU2027**  
Lower Control Arm

**AU2028**  
Lower Control Arm

**AU2826**  
Shock Mounting



**AU2118**  
Lower Control Arm Bush

**AU2826**  
Shock Mounting



**GOLF VII**

**REAR**

**AU1512**  
Link Stabilizer  
L=70.2



**AU2611**  
Lateral Link



**AU2818**  
Shock Mounting



**AU2818**  
Shock Mounting



**LEFT**

**RIGHT**

**VOLKSWAGEN**

JETTA I

FRONT

ALL MODELS

Year

1980-1985

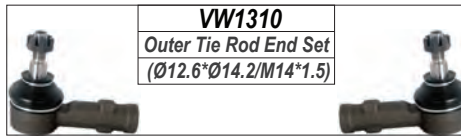

**VW1310**  
Outer Tie Rod End Set  
(Ø12.6\*Ø14.2/M14\*1.5)

**VW1012**  
Outer Tie Rod End  
(Ø12.6\*Ø14.2/M14\*1.5)

**VW1414**  
Rack End  
(22\*1.5 /14\*1.5/341)

**VW1012**  
Outer Tie Rod End  
(Ø12.6\*Ø14.2/M14\*1.5)



**VW1512**  
Link Stabilizer  
L=75



**VW1911**  
Lower Ball Joint  
(Ø17)



**VW1911**  
Lower Ball Joint  
(Ø17)



**VW2115**  
Lower Control Arm Bush



**VW1914**  
Lower Ball Joint  
(Ø15)



**VW2015**  
Lower Control Arm

**VW2016**  
Lower Control Arm

**VW1914**  
Lower Ball Joint  
(Ø15)



**VW2821**  
Shock Mounting



**VW2116**  
Lower Control Arm Bush



**VW2821**  
Shock Mounting



JETTA I

REAR

**VW2823**  
Shock Mounting  
ID:18 H:84



**VW2823**  
Shock Mounting  
ID:18 OD:29



**VW2824**  
Shock Mounting  
ID:31 H:38



**VW2824**  
Shock Mounting  
ID:31 H:38



LEFT

RIGHT



**VOLKSWAGEN**

JETTA II

FRONT

ALL MODELS

Year

1985-1992

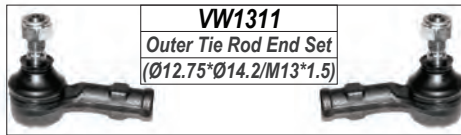

**VW1311**  
Outer Tie Rod End Set  
(Ø12.75\*Ø14.2/M13\*1.5)

**VW1013**  
Outer Tie Rod End  
(Ø12.75\*Ø14.2/M13\*1.5)

**VW1415**  
Rack End  
(22\*1.5/14\*1.5/368)(M/S)

**VW1014**  
Outer Tie Rod End  
(Ø12.75\*Ø14.2/M13\*1.5)



**VW1416**  
Rack End  
(14\*1.5/14\*1.5/340)(P/S)



**VW1512**  
Link Stabilizer  
L=75

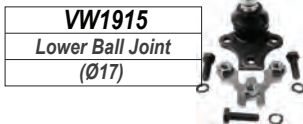

**VW1915**  
Lower Ball Joint  
(Ø17)



**VW2021**  
Lower Control Arm

**VW2022**  
Lower Control Arm

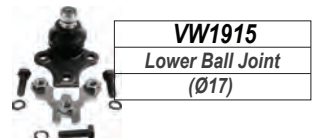

**VW1915**  
Lower Ball Joint  
(Ø17)

**AU2113**  
Lower Control Arm Bush

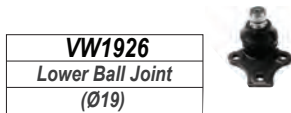

**VW1926**  
Lower Ball Joint  
(Ø19)

**VW2117**  
Lower Control Arm Bush

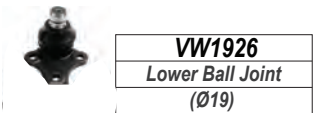

**VW1926**  
Lower Ball Joint  
(Ø19)



**VW2023**  
Lower Control Arm

**VW2024**  
Lower Control Arm

**AU2113**  
Lower Control Arm Bush

**VW2117**  
Lower Control Arm Bush

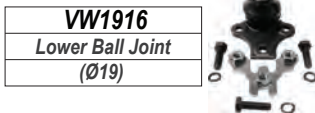

**VW1916**  
Lower Ball Joint  
(Ø19)

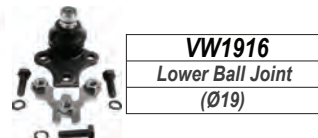

**VW1916**  
Lower Ball Joint  
(Ø19)

**VW2822**  
Shock Mounting



**VW2813**  
Stabilizer Bar Bush  
ID:17 OD:35



**VW2814**  
Stabilizer Bar Bush  
ID:19 OD:37



**VW2822**  
Shock Mounting



JETTA II

REAR

**VW2823**  
Shock Mounting  
ID:18 H:84



**VW2824**  
Shock Mounting  
ID:31 H:38



**VW2914**  
Bush

**VW2824**  
Shock Mounting  
ID:31 H:38



**VW2823**  
Shock Mounting  
ID:18 OD:29



LEFT

RIGHT

**VOLKSWAGEN**

JETTA III

FRONT

ALL MODELS

Year

1992-1999

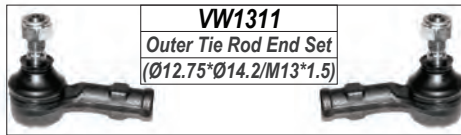

**VW1311**  
Outer Tie Rod End Set  
(Ø12.75\*Ø14.2/M13\*1.5)

**VW1013**  
Outer Tie Rod End  
(Ø12.75\*Ø14.2/M13\*1.5)

**VW1417**  
Rack End  
(22\*1.5/14\*1.5/381)(M/S)

**VW1014**  
Outer Tie Rod End  
(Ø12.75\*Ø14.2/M13\*1.5)



**VW1418**  
Rack End  
(14\*1.5/14\*1.5/369)(P/S)



**VW1512**  
Link Stabilizer  
L=75



**AU2914**  
Stabilizer Bar Bush  
(ID: Ø19.2/OD: Ø37)

**AU2810**  
Bush  
(ID: Ø19.2/OD: Ø37)

**VW2814**  
Stabilizer Bar Bush  
ID:19 OD:37



**VW1512**  
Link Stabilizer  
L=75

**VW1514**  
Link Stabilizer  
L=51



**VW1514**  
Link Stabilizer  
L=51

**VW1515**  
Link Stabilizer  
L=78



**VW1515**  
Link Stabilizer  
L=78

**VW1926**  
Lower Ball Joint  
(Ø19)



**AU2113**  
Lower Control Arm Bush



**VW1926**  
Lower Ball Joint  
(Ø19)



**VW1916**  
Lower Ball Joint  
(Ø19)



**VW2050**  
Lower Control Arm

**VW2117**  
Lower Control Arm Bush



**VW2051**  
Lower Control Arm



**VW1916**  
Lower Ball Joint  
(Ø19)

**VW1917**  
Lower Ball Joint  
(Ø16.5)(VR6 Only)



**VW1917**  
Lower Ball Joint  
(Ø16.5)(VR6 Only)

**VW2825**  
Shock Mounting



**VW2026**  
Lower Control Arm  
VR6 Only

**AU2113**  
Lower Control Arm Bush



**VW2027**  
Lower Control Arm  
VR6 Only

**VW2825**  
Shock Mounting



**VW2117**  
Lower Control Arm Bush

**GOLF III**

**REAR**

**VW2823**  
Shock Mounting  
ID:18 H:84



**VW2824**  
Shock Mounting  
ID:31 H:38



**VW2914**  
Bush



**VW2824**  
Shock Mounting  
ID:31 H:38



**VW2823**  
Shock Mounting  
ID:18 OD:29



LEFT

RIGHT

**VOLKSWAGEN**

JETTA IV

FRONT

ALL MODELS

Year

1999-2005

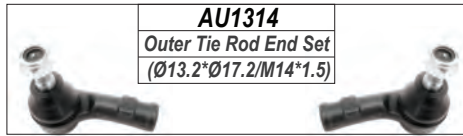

**AU1314**  
Outer Tie Rod End Set  
(Ø13.2\*Ø17.2/M14\*1.5)

**AU1018**  
Outer Tie Rod End  
(Ø13.2\*Ø17.2/M14\*1.5)

**AU1412**  
Rack End  
(16\*1.5 /14\*1.5/341)

**AU1019**  
Outer Tie Rod End  
(Ø13.2\*Ø17.2/M14\*1.5)

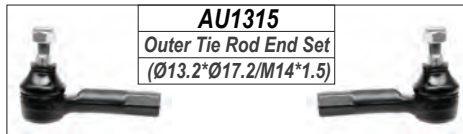

**AU1315**  
Outer Tie Rod End Set  
(Ø13.2\*Ø17.2/M14\*1.5)

**AU1020**  
Outer Tie Rod End  
(Ø13.2\*Ø17.2/M14\*1.5)

**AU1411**  
Rack End  
(16\*1.5 /14\*1.5/320)

**AU1021**  
Outer Tie Rod End  
(Ø13.2\*Ø17.2/M14\*1.5)

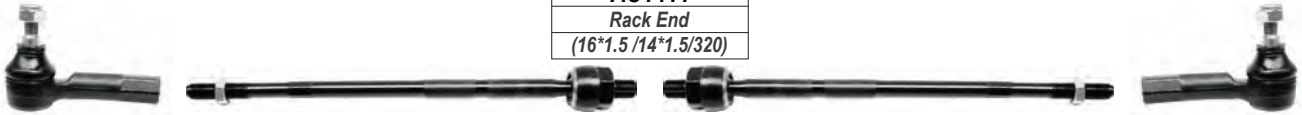

**AU1915**  
Lower Ball Joint  
(Ø14.9)



**AU2113**  
Lower Control Arm Bush



**AU1916**  
Lower Ball Joint  
(Ø14.9)

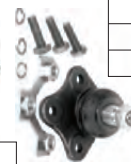

**AU2019**  
Lower Control Arm

**AU2020**  
Lower Control Arm

**AU1513**  
Link Stabilizer  
L=105.5



**AU1513**  
Link Stabilizer  
L=105.5



**AU2114**  
Lower Control Arm Bush



**AU1514**  
Link Stabilizer  
L=105.5



**AU1514**  
Link Stabilizer  
L=105.5



**AU1545**  
Link Stabilizer  
L=335



**AU2810**  
Stabilizer Bar Bush



**AU1546**  
Link Stabilizer  
L=335



**AU2814**  
Shock Mounting



**AU2814**  
Shock Mounting



LEFT

RIGHT

**VOLKSWAGEN**

JETTA IV

REAR

ALL MODELS

Year

1999-2005

**AU1517**

Link Stabilizer

L=175

**VW2910**

Bush



**VW2910**

Bush



**VW2610**

Lateral Link



**VW2610**

Lateral Link



**VW2611**

Lateral Link



**VW2611**

Lateral Link

**AU2913**

Bush

(ID: Ø12.2/OD: Ø50)



**AU2912**

Bush

(ID: Ø12.2/OD: Ø71.5)



**AU2815**

Shock Mounting



**AU2815**

Shock Mounting



**LEFT**

**RIGHT**







**VOLKSWAGEN**

JETTA V

REAR

ALL MODELS

Year

2005-

**AU1519**  
Link Stabilizer  
L=95.5



**AU2915**  
Bush  
(ID: Ø14.3/OD: Ø24.3)



**VW2911**  
Bush



**AU2610**  
Lateral Link



**AU2610**  
Lateral Link



**VW2911**  
Bush



**AU1710**  
Upper Control Arm



**AU2080 / AU2081**  
Lower Control Arm

**VW2114**  
Lower Control Arm Bush



**VW2014**  
Lower Control Arm



**VW2014**  
Lower Control Arm



**AU2818**  
Shock Mounting



**AU2818**  
Shock Mounting



LEFT

RIGHT

**VOLKSWAGEN**

JETTA VI

FRONT

ALL MODELS

Year

2010-

**AU1316**

Outer Tie Rod End Set  
(Ø13.3\*Ø16.4/M16\*1.5)

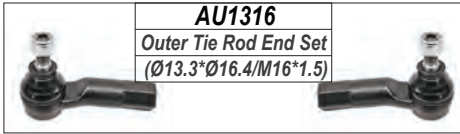

**AU1030**

Outer Tie Rod End  
(Ø13.3\*Ø16.4/M16\*1.5)



**AU1413**

Rack End  
(16\*1.5 /16\*1.5/309)



**AU1031**

Outer Tie Rod End  
(Ø13.3\*Ø16.4/M16\*1.5)



**AU1518**

Link Stabilizer  
L=335



**AU1917**

Lower Ball Joint  
(Ø15.4)



**AU2115**

Lower Control Arm Bush



**AU1918**

Lower Ball Joint  
(Ø15.4)



**VW2048**

Lower Control Arm

**VW2049**

Lower Control Arm

**VW2113**

Lower Control Arm Bush



**AU2914**

Bush

(ID: Ø19.2/OD: Ø37)

**AU2810**

Bush

(ID: Ø19.2/OD: Ø37)



**AU2817**

Shock Mounting



**AU2817**

Shock Mounting



LEFT

RIGHT

**VOLKSWAGEN**

**JETTA VI**

**REAR**

**ALL MODELS**

*Year*

**2010-**

**AU1519**  
Link Stabilizer  
L=95.5



**AU2915**  
Bush  
(ID: Ø14.3/OD: Ø24.3)



**VW2911**  
Bush



**AU2610**  
Lateral Link



**AU2610**  
Lateral Link

**VW2911**  
Bush



**AU1710**  
Upper Control Arm



**AU2080 / AU2081**  
Lower Control Arm

**VW2114**  
Lower Control Arm Bush



**VW2014**  
Lower Control Arm

**VW2014**  
Lower Control Arm

**AU2818**  
Shock Mounting



**AU2818**  
Shock Mounting



**LEFT**

**RIGHT**

**VOLKSWAGEN**

**KOMBI (T2) (T3) FRONT**

**ALL MODELS**

*Year*

**1979-1992**

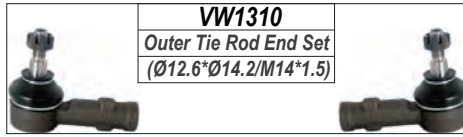

**VW1310**  
Outer Tie Rod End Set  
(Ø12.6\*Ø14.2/M14\*1.5)

**VW1012**  
Outer Tie Rod End  
(Ø12.6\*Ø14.2/M14\*1.5)

**VW1419**  
Rack End  
(14\*1.5/14\*1.5/379)

**VW1012**  
Outer Tie Rod End  
(Ø12.6\*Ø14.2/M14\*1.5)



**VW1811**  
Upper Control Arm Bush  
ID:18.5 OD:36-54 L:54



**VW1611**  
Lower Ball Joint  
(Ø18.1)



**VW1611**  
Lower Ball Joint  
(Ø18.1)



**VW1918**  
Lower Ball Joint  
(Ø19.7)



**VW1918**  
Lower Ball Joint  
(Ø19.7)



**VW2915**  
Bush  
ID:13 OD:26 L:28



**VW2916**  
Bush  
ID:9 OD:28 L:28



**LEFT**

**RIGHT**

**VOLKSWAGEN**











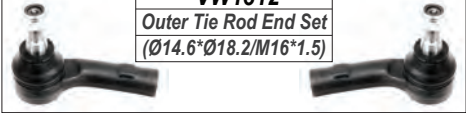

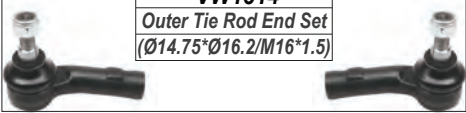





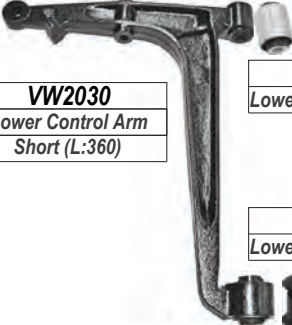
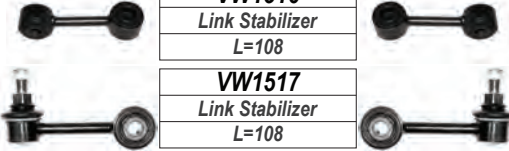
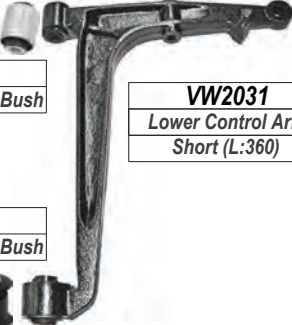

**KOMBI (T4)**

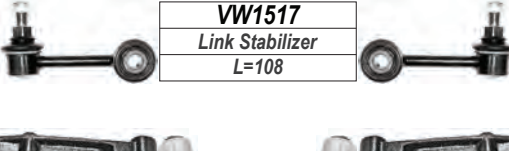
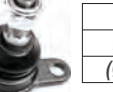
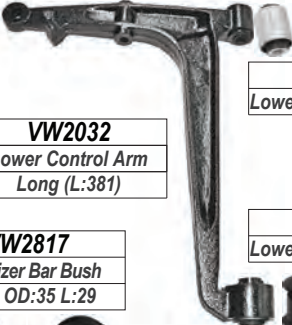
**FRONT**

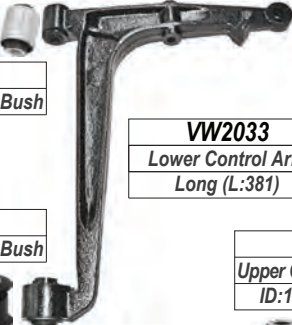
**ALL MODELS**

*Year*

**1999-2004**

<p><b>VW1015</b> Outer Tie Rod End (Ø14.6*Ø18.2/M16*1.5)</p> 	<p><b>VW1312</b> Outer Tie Rod End Set (Ø14.6*Ø18.2/M16*1.5)</p> 	<p><b>VW1016</b> Outer Tie Rod End (Ø14.6*Ø18.2/M16*1.5)</p> 
<p><b>VW1019</b> Outer Tie Rod End (Ø14.75*Ø16.2/M16*1.5)</p> 	<p><b>VW1314</b> Outer Tie Rod End Set (Ø14.75*Ø16.2/M16*1.5)</p> 	<p><b>VW1020</b> Outer Tie Rod End (Ø14.75*Ø16.2/M16*1.5)</p> 
<p><b>VW1612</b> Upper Ball Joint (Ø17.9)</p> 	<p><b>VW1420</b> Rack End (14*1.5 /16*1.5/293)</p> 	<p><b>VW1612</b> Upper Ball Joint (Ø17.9)</p> 
<p><b>VW1919</b> Lower Ball Joint (Ø20.3)(Width:104)</p> 	<p><b>VW1421</b> Rack End (14*1.5 /16*1.5/294)</p> 	<p><b>VW1919</b> Lower Ball Joint (Ø20.3)(Width:104)</p> 
<p><b>VW2030</b> Lower Control Arm Short (L:360)</p> 	<p><b>VW1516</b> Link Stabilizer L=108</p> 	<p><b>VW2031</b> Lower Control Arm Short (L:360)</p> 
<p><b>VW1920</b> Lower Ball Joint (Ø20.3)(Width:102)</p> 	<p><b>VW1517</b> Link Stabilizer L=108</p> 	<p><b>VW1920</b> Lower Ball Joint (Ø20.3)(Width:102)</p> 
<p><b>VW2032</b> Lower Control Arm Long (L:381)</p> 	<p><b>VW2118</b> Lower Control Arm Bush</p> 	<p><b>VW2033</b> Lower Control Arm Long (L:381)</p> 
<p><b>VW2816</b> Stabilizer Bar Bush ID:22 L:31</p> 	<p><b>VW2119</b> Lower Control Arm Bush</p> 	<p><b>VW2917</b> Upper Control Arm Bush ID:12 OD:39 L:60</p> 
<p><b>VW2817</b> Stabilizer Bar Bush ID:20 OD:35 L:29</p> 	<p><b>VW2119</b> Lower Control Arm Bush</p> 	<p><b>VW2918</b> Upper Control Arm Bush ID:14 OD:35 L:60</p> 

**LEFT**

**RIGHT**



**VOLKSWAGEN**



















**KOMBI (T5)**

**FRONT**

**ALL MODELS**

**Year**

**2004-**

		<table border="1"> <tr><td><b>VW1316</b></td></tr> <tr><td>Outer Tie Rod End Set</td></tr> <tr><td>(Ø16.7*Ø20.3/M16*1.5)</td></tr> </table> 	<b>VW1316</b>	Outer Tie Rod End Set	(Ø16.7*Ø20.3/M16*1.5)									
<b>VW1316</b>														
Outer Tie Rod End Set														
(Ø16.7*Ø20.3/M16*1.5)														
<table border="1"> <tr><td><b>VW1023</b></td></tr> <tr><td>Outer Tie Rod End</td></tr> <tr><td>(Ø16.7*Ø20.3/M16*1.5)</td></tr> </table> 	<b>VW1023</b>	Outer Tie Rod End	(Ø16.7*Ø20.3/M16*1.5)		<table border="1"> <tr><td><b>VW1422</b></td></tr> <tr><td>Rack End</td></tr> <tr><td>(16*1.5 /16*1.5/176)</td></tr> </table> 	<b>VW1422</b>	Rack End	(16*1.5 /16*1.5/176)		<table border="1"> <tr><td><b>VW1024</b></td></tr> <tr><td>Outer Tie Rod End</td></tr> <tr><td>(Ø16.7*Ø20.3/M16*1.5)</td></tr> </table> 	<b>VW1024</b>	Outer Tie Rod End	(Ø16.7*Ø20.3/M16*1.5)	
<b>VW1023</b>														
Outer Tie Rod End														
(Ø16.7*Ø20.3/M16*1.5)														
<b>VW1422</b>														
Rack End														
(16*1.5 /16*1.5/176)														
<b>VW1024</b>														
Outer Tie Rod End														
(Ø16.7*Ø20.3/M16*1.5)														
		<table border="1"> <tr><td><b>VW1518</b></td></tr> <tr><td>Link Stabilizer</td></tr> <tr><td>L=260</td></tr> </table> 	<b>VW1518</b>	Link Stabilizer	L=260									
<b>VW1518</b>														
Link Stabilizer														
L=260														
<table border="1"> <tr><td><b>VW1921</b></td></tr> <tr><td>Lower Ball Joint</td></tr> <tr><td>(Ø18.2)</td></tr> </table> 	<b>VW1921</b>	Lower Ball Joint	(Ø18.2)		<table border="1"> <tr><td><b>VW1921</b></td></tr> <tr><td>Lower Ball Joint</td></tr> <tr><td>(Ø18.2)</td></tr> </table> 	<b>VW1921</b>	Lower Ball Joint	(Ø18.2)						
<b>VW1921</b>														
Lower Ball Joint														
(Ø18.2)														
<b>VW1921</b>														
Lower Ball Joint														
(Ø18.2)														
<table border="1"> <tr><td><b>VW1919</b></td></tr> <tr><td>Lower Ball Joint</td></tr> <tr><td>(Ø20.3)(Width:104)</td></tr> </table> 	<b>VW1919</b>	Lower Ball Joint	(Ø20.3)(Width:104)		<table border="1"> <tr><td><b>VW2110</b></td></tr> <tr><td>Lower Control Arm Bush</td></tr> </table> 	<b>VW2110</b>	Lower Control Arm Bush		<table border="1"> <tr><td><b>VW1919</b></td></tr> <tr><td>Lower Ball Joint</td></tr> <tr><td>(Ø20.3)(Width:104)</td></tr> </table> 	<b>VW1919</b>	Lower Ball Joint	(Ø20.3)(Width:104)		
<b>VW1919</b>														
Lower Ball Joint														
(Ø20.3)(Width:104)														
<b>VW2110</b>														
Lower Control Arm Bush														
<b>VW1919</b>														
Lower Ball Joint														
(Ø20.3)(Width:104)														
<table border="1"> <tr><td><b>VW1922</b></td></tr> <tr><td>Lower Ball Joint</td></tr> <tr><td>(Ø18.2)(Increased Payload)</td></tr> </table> 	<b>VW1922</b>	Lower Ball Joint	(Ø18.2)(Increased Payload)	<table border="1"> <tr><td><b>VW2034</b></td></tr> <tr><td>Lower Control Arm</td></tr> </table> 	<b>VW2034</b>	Lower Control Arm	<table border="1"> <tr><td><b>VW2035</b></td></tr> <tr><td>Lower Control Arm</td></tr> </table> 	<b>VW2035</b>	Lower Control Arm	<table border="1"> <tr><td><b>VW1922</b></td></tr> <tr><td>Lower Ball Joint</td></tr> <tr><td>(Ø18.2)(Increased Payload)</td></tr> </table> 	<b>VW1922</b>	Lower Ball Joint	(Ø18.2)(Increased Payload)	
<b>VW1922</b>														
Lower Ball Joint														
(Ø18.2)(Increased Payload)														
<b>VW2034</b>														
Lower Control Arm														
<b>VW2035</b>														
Lower Control Arm														
<b>VW1922</b>														
Lower Ball Joint														
(Ø18.2)(Increased Payload)														
		<table border="1"> <tr><td><b>VW2120</b></td></tr> <tr><td>Lower Control Arm Bush</td></tr> </table> 	<b>VW2120</b>	Lower Control Arm Bush										
<b>VW2120</b>														
Lower Control Arm Bush														
<table border="1"> <tr><td><b>VW2826</b></td></tr> <tr><td>Shock Mounting</td></tr> </table> 	<b>VW2826</b>	Shock Mounting	<table border="1"> <tr><td><b>VW2818</b></td></tr> <tr><td>Stabilizer Bar Bush</td></tr> <tr><td>ID:21 OD:35 L:52.5</td></tr> </table> 	<b>VW2818</b>	Stabilizer Bar Bush	ID:21 OD:35 L:52.5	<table border="1"> <tr><td><b>VW2819</b></td></tr> <tr><td>Stabilizer Bar Bush</td></tr> <tr><td>ID:22 OD:34 L:52</td></tr> </table> 	<b>VW2819</b>	Stabilizer Bar Bush	ID:22 OD:34 L:52	<table border="1"> <tr><td><b>VW2826</b></td></tr> <tr><td>Shock Mounting</td></tr> </table> 	<b>VW2826</b>	Shock Mounting	
<b>VW2826</b>														
Shock Mounting														
<b>VW2818</b>														
Stabilizer Bar Bush														
ID:21 OD:35 L:52.5														
<b>VW2819</b>														
Stabilizer Bar Bush														
ID:22 OD:34 L:52														
<b>VW2826</b>														
Shock Mounting														

**KOMBI (T5)**

**REAR**

<b>VW2920</b>
Bush
ID:21 L:43



<b>VW2921</b>
Bush
ID:23 L:44



**LEFT**

**RIGHT**

**VOLKSWAGEN**

LT

FRONT

28-35-46

Year

1996-

**ME1050**  
Outer Tie Rod End  
(Ø18.2\*Ø20.5/M16\*1.5)

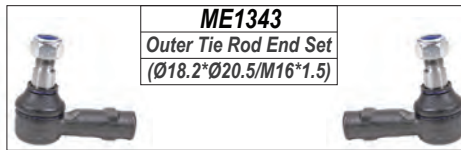

**ME1343**  
Outer Tie Rod End Set  
(Ø18.2\*Ø20.5/M16\*1.5)

**ME1421**  
Rack End  
(16\*1.5/16\*1.5/385)

**ME1050**  
Outer Tie Rod End  
(Ø18.2\*Ø20.5/M16\*1.5)

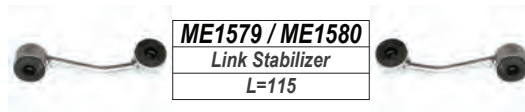

**ME1579 / ME1580**  
Link Stabilizer  
L=115

**ME1930**  
Lower Ball Joint  
(Ø23.5)



**ME2147**  
Lower Control Arm Bush

**ME2077**  
Lower Control Arm

**ME2078**  
Lower Control Arm

**ME1930**  
Lower Ball Joint  
(Ø23.5)



**ME2815**  
Shock Mounting(Upper)



**ME2815**  
Shock Mounting(Upper)



**ME2826**  
Shock Mounting(Lower)



**ME2826**  
Shock Mounting(Lower)



LT

REAR



**ME1581**  
Link Stabilizer  
L=94.5

LEFT

RIGHT

**VOLKSWAGEN**













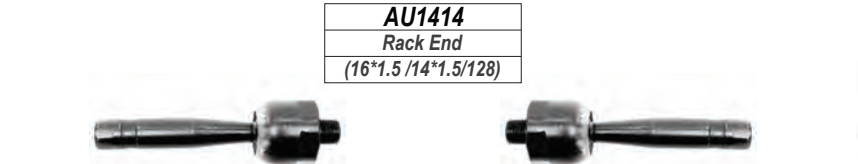











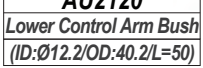

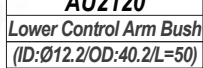
PASSAT V

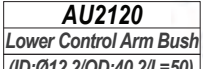
FRONT

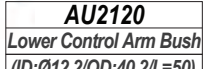
ALL MODELS

Year

1999-2005

	 <p><b>AU1317</b> Outer Tie Rod End Set (Ø13.6*Ø14.8/M14*1.5)</p>		
 <p><b>AU1022</b> Outer Tie Rod End (Ø13.6*Ø14.8/M14*1.5)</p>	 <p><b>AU1414</b> Rack End (16*1.5 /14*1.5/128)</p>		 <p><b>AU1022</b> Outer Tie Rod End (Ø13.6*Ø14.8/M14*1.5)</p>
 <p><b>AU1523</b> Link Stabilizer L=86</p>	 <p><b>AU1810</b> Upper Control Arm Bush</p>		 <p><b>AU1523</b> Link Stabilizer L=86</p>
	 <p><b>AU1711</b> Upper Control Arm</p>		
	 <p><b>AU1712</b> Upper Control Arm</p>		
 <p><b>AU1521</b> Link Stabilizer L=90</p>	 <p><b>AU1810</b> Upper Control Arm Bush</p>		 <p><b>AU1522</b> Link Stabilizer L=90</p>
	 <p><b>AU1713</b> Upper Control Arm</p>		
	 <p><b>AU1714</b> Upper Control Arm</p>		
	 <p><b>AU2121</b> Lower Control Arm Bush</p>		
 <p><b>AU2120</b> Lower Control Arm Bush (ID:Ø12.2/OD:40.2/L=50)</p>	 <p><b>AU2029</b> Lower Control Arm (Ø20.6)</p>		 <p><b>AU2120</b> Lower Control Arm Bush (ID:Ø12.2/OD:40.2/L=50)</p>
	 <p><b>AU2121</b> Lower Control Arm Bush</p>		
 <p><b>AU2120</b> Lower Control Arm Bush (ID:Ø12.2/OD:40.2/L=50)</p>	 <p><b>AU2033</b> Lower Control Arm (Ø16.3)</p>		 <p><b>AU2120</b> Lower Control Arm Bush (ID:Ø12.2/OD:40.2/L=50)</p>
	 <p><b>AU2119</b> Lower Control Arm Bush</p>		
 <p><b>AU2819</b> Shock Mounting</p>	 <p><b>AU2030</b> Lower Control Arm</p>		 <p><b>AU2819</b> Shock Mounting</p>
	 <p><b>AU2031</b> Lower Control Arm</p>		

PASSAT V

REAR

**AU2824**  
Shock Mounting



**AU1531**  
Link Stabilizer  
L=57.4



**AU2824**  
Shock Mounting



LEFT

RIGHT

**VOLKSWAGEN**  
**PASSAT VI FRONT**

**ALL MODELS**

Year

**2005-2011**

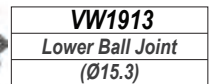
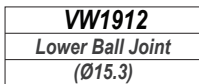
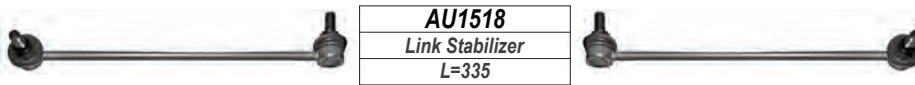
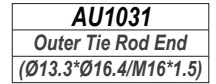
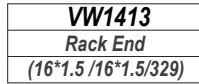
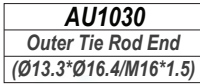
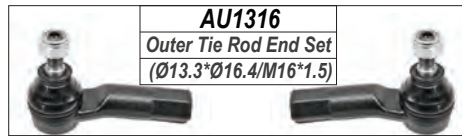

**PASSAT VI REAR**

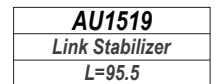
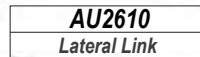
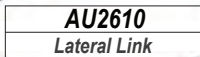
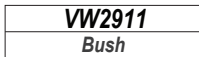
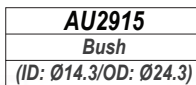

**LEFT**

**RIGHT**



**VOLKSWAGEN**

PASSAT VII

FRONT

ALL MODELS

Year

2010-

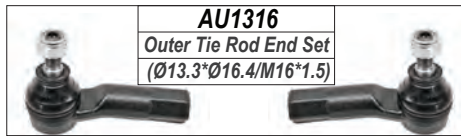

**AU1030**  
Outer Tie Rod End  
(Ø13.3\*Ø16.4/M16\*1.5)

**VW1413**  
Rack End  
(16\*1.5/16\*1.5/329)

**AU1031**  
Outer Tie Rod End  
(Ø13.3\*Ø16.4/M16\*1.5)



**AU1413**  
Rack End  
(16\*1.5/16\*1.5/309)



**AU1518**  
Link Stabilizer  
L=335

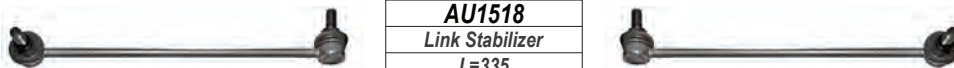

**AU2115**  
Lower Control Arm Bush



**VW2038**  
Lower Control Arm

**VW2039**  
Lower Control Arm

**AU1917**  
Lower Ball Joint  
(Ø15.4)



**AU2134**  
Lower Control Arm Bush

**AU1918**  
Lower Ball Joint  
(Ø15.4)



**AU2115**  
Lower Control Arm Bush



**VW2012**  
Lower Control Arm

**VW2013**  
Lower Control Arm

**VW2113**  
Lower Control Arm Bush

PASSAT VII

REAR

**AU1519**  
Link Stabilizer  
L=95.5



LEFT

RIGHT



**VOLKSWAGEN**

**POLO I**

**FRONT**

**CLASSIC.PLAYA**

*Year*

**1995-2003**

**VW1013**  
Outer Tie Rod End  
(Ø12.75\*Ø14.2/M14\*1.5)

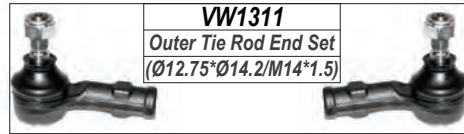

**VW1311**  
Outer Tie Rod End Set  
(Ø12.75\*Ø14.2/M14\*1.5)

**VW1423**  
Rack End  
(14\*1.5\*14\*1.5/296)

**VW1014**  
Outer Tie Rod End  
(Ø12.75\*Ø14.2/M14\*1.5)



**VW1025**  
Outer Tie Rod End  
(Ø12.75\*Ø14.2/M14\*1.5)

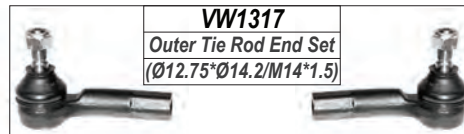

**VW1317**  
Outer Tie Rod End Set  
(Ø12.75\*Ø14.2/M14\*1.5)

**VW1416**  
Rack End  
(14\*1.5/14\*1.5/340)

**VW1026**  
Outer Tie Rod End  
(Ø12.75\*Ø14.2/M14\*1.5)

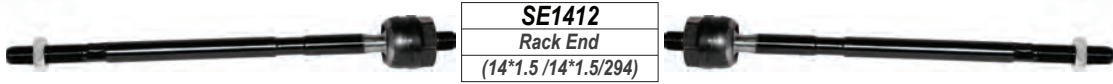

**SE1412**  
Rack End  
(14\*1.5 /14\*1.5/294)

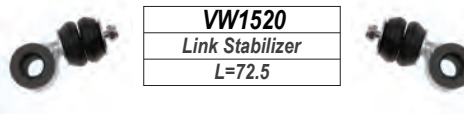

**VW1520**  
Link Stabilizer  
L=72.5

**VW1926**  
Lower Ball Joint  
(Ø19)



**AU2113**  
Lower Control Arm Bush

**VW1926**  
Lower Ball Joint  
(Ø19)



**VW1916**  
Lower Ball Joint  
(Ø19)



**VW2023**  
Lower Control Arm

**VW2024**  
Lower Control Arm

**VW1916**  
Lower Ball Joint  
(Ø19)



**VW2825**  
Shock Mounting



**VW2117**  
Lower Control Arm Bush



**VW2825**  
Shock Mounting



**POLO I**

**REAR**

**VW2823**  
Shock Mounting  
ID:18 H:84



**VW2824**  
Shock Mounting  
ID:31 H:38



**VW2824**  
Shock Mounting  
ID:31 H:38



**VW2823**  
Shock Mounting  
ID:18 OD:29



**LEFT**

**RIGHT**

**VOLKSWAGEN**

**POLO II**

**FRONT**

**ALL MODELS**

*Year*

**2003-2009**

**AU1020**  
Outer Tie Rod End  
(Ø13.2\*Ø17.2/M14\*1.5)

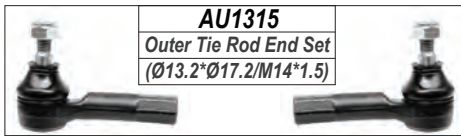

**AU1315**  
Outer Tie Rod End Set  
(Ø13.2\*Ø17.2/M14\*1.5)

**AU1021**  
Outer Tie Rod End  
(Ø13.2\*Ø17.2/M14\*1.5)



**AU1016**  
Outer Tie Rod End  
(Ø13.2\*Ø17.2/M14\*1.5)

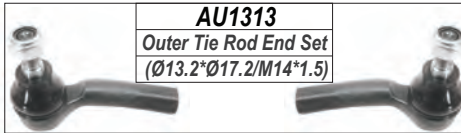

**AU1313**  
Outer Tie Rod End Set  
(Ø13.2\*Ø17.2/M14\*1.5)

**AU1017**  
Outer Tie Rod End  
(Ø13.2\*Ø17.2/M14\*1.5)



**VW1424**  
Rack End  
(14\*1.5/14\*1.5/297)



**SE1412**  
Rack End  
(14\*1.5/14\*1.5/294)



**VW1416**  
Rack End  
(14\*1.5/14\*1.5/340)



**AU1511**  
Link Stabilizer  
L=271



**SE1910**  
Lower Ball Joint  
(Ø14.9)



**SE2010**  
Lower Control Arm

**SE2110**  
Lower Control Arm Bush



**SE2010**  
Lower Control Arm

**SE1911**  
Lower Ball Joint  
(Ø14.9)



**VW2827**  
Shock Mounting



**SE2111**  
Lower Control Arm Bush



**VW2827**  
Shock Mounting



**POLO II**

**REAR**

**AU2815**  
Shock Mounting



**AU2912**  
Bush  
(ID: Ø12.2/OD: Ø71.5)



**AU2815**  
Shock Mounting



**LEFT**

**RIGHT**

**VOLKSWAGEN**

**POLO III**

**FRONT**

**(6R) (VIVO)**

Year

**2009-2014**

**AU1020**  
Outer Tie Rod End  
(Ø13.2\*Ø17.2/M14\*1.5)



**AU1016**  
Outer Tie Rod End  
(Ø13.2\*Ø17.2/M14\*1.5)

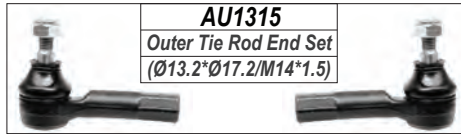

**AU1315**  
Outer Tie Rod End Set  
(Ø13.2\*Ø17.2/M14\*1.5)

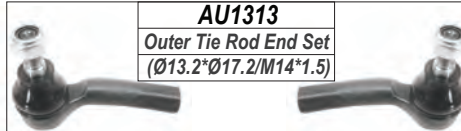

**AU1313**  
Outer Tie Rod End Set  
(Ø13.2\*Ø17.2/M14\*1.5)

**AU1021**  
Outer Tie Rod End  
(Ø13.2\*Ø17.2/M14\*1.5)



**AU1017**  
Outer Tie Rod End  
(Ø13.2\*Ø17.2/M14\*1.5)



**VW1424**  
Rack End  
(14\*1.5/14\*1.5/297)



**SE1412**  
Rack End  
(14\*1.5/14\*1.5/294)



**VW1416**  
Rack End  
(14\*1.5/14\*1.5/340)



**VW1425**  
Rack End  
(16\*1.5/14\*1.5/303)



**AU1410**  
Rack End  
(14\*1.5/14\*1.5/310)



**VW2040**  
Lower Control Arm

**AU1511**  
Link Stabilizer  
L=271



**VW2041**  
Lower Control Arm

**AU2113**  
Lower Control Arm Bush

**AU2114**  
Lower Control Arm Bush

**AU2113**  
Lower Control Arm Bush

**AU2114**  
Lower Control Arm Bush

**AU1913**  
Lower Ball Joint  
(Ø14.9)



**AU1914**  
Lower Ball Joint  
(Ø14.9)



**AU2016**  
Lower Control Arm



**AU2017**  
Lower Control Arm

**VW2827**  
Shock Mounting



**VW2827**  
Shock Mounting



**POLO III**

**REAR**

**AU2815**  
Shock Mounting



**LEFT**

**RIGHT**

**VOLKSWAGEN**

**POLO III**

**FRONT**

**(6C)**

**Year**

**2014-**

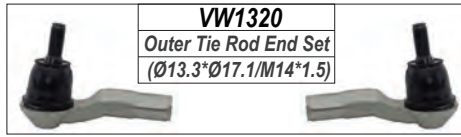

**VW1320**  
Outer Tie Rod End Set  
(Ø13.3\*Ø17.1/M14\*1.5)

**VW1010**  
Outer Tie Rod End  
(Ø13.3\*Ø17.1/M14\*1.5)



**VW1410**  
Rack End  
(14\*1.5/14\*1.5/312)



**VW1011**  
Outer Tie Rod End  
(Ø13.3\*Ø17.1/M14\*1.5)



**AU1511**  
Link Stabilizer  
L=271



**AU1913**  
Lower Ball Joint  
(Ø14.9)



**AU2113**  
Lower Control Arm Bush



**AU1914**  
Lower Ball Joint  
(Ø14.9)



**AU2016**  
Lower Control Arm



**AU2017**  
Lower Control Arm



**AU2814**  
Shock Mounting



**AU2114**  
Lower Control Arm Bush



**AU2814**  
Shock Mounting



**POLO III**

**REAR**

**AU2815**  
Shock Mounting



**AU2815**  
Shock Mounting



**LEFT**

**RIGHT**



**VOLKSWAGEN**

POLO

FRONT

AW

Year

2018-

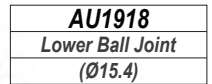
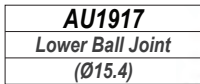
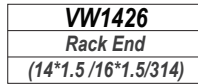
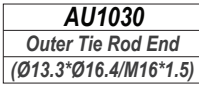
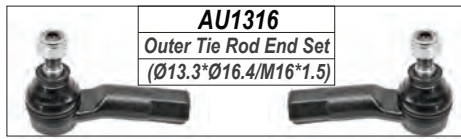

LEFT

RIGHT



**VOLKSWAGEN**

SCIROCCO

FRONT

ALL MODELS

Year

2009-

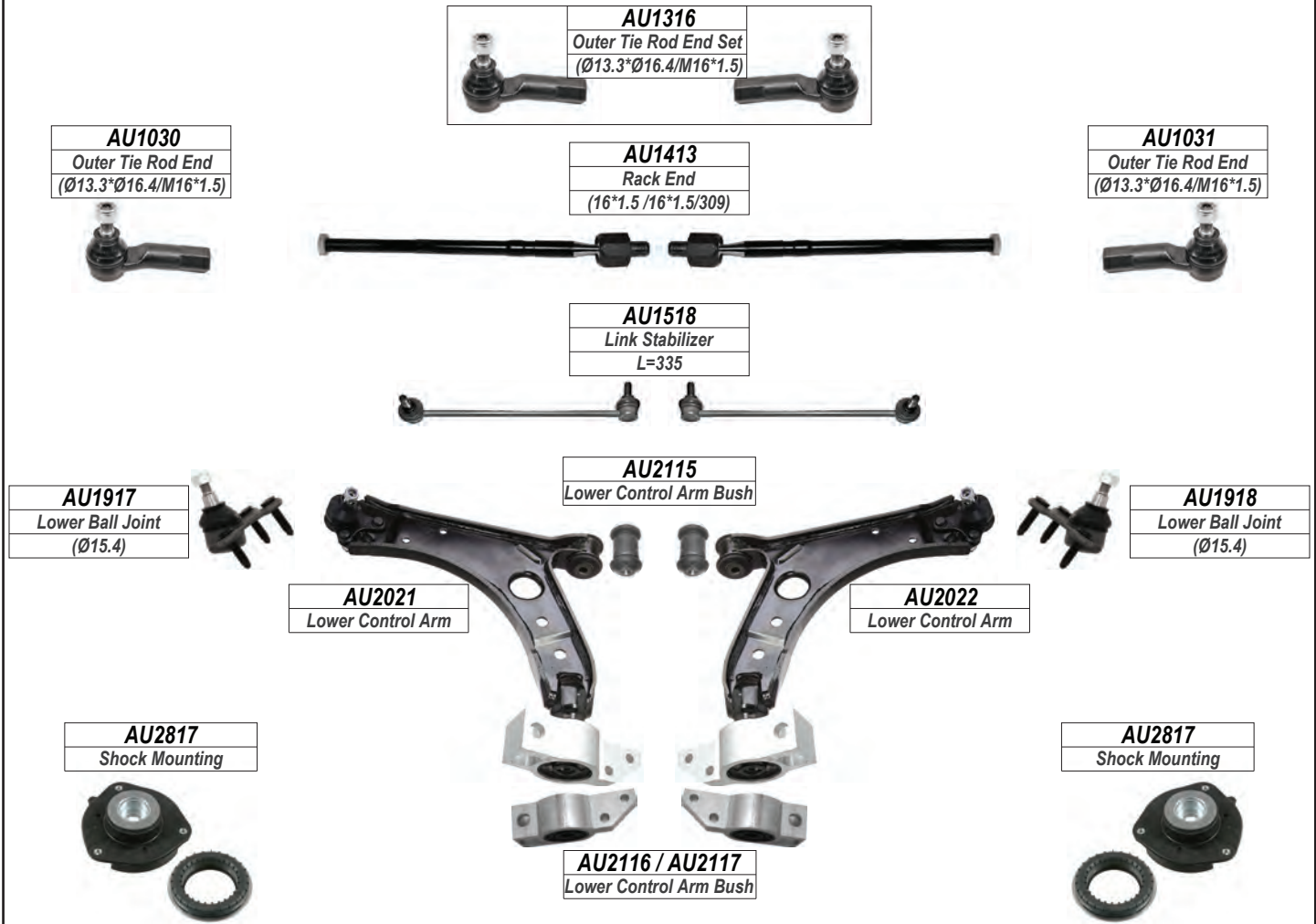

SCIROCCO

REAR



LEFT

RIGHT

**VOLKSWAGEN**

SHARAN

FRONT

ALL MODELS

Year

1999-

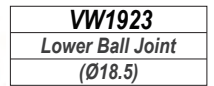
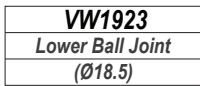
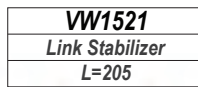
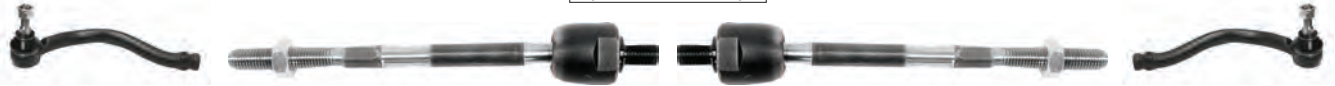
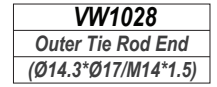
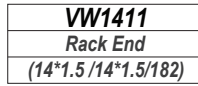

LEFT

RIGHT

**VOLKSWAGEN**

TIGUAN

FRONT

ALL MODELS

Year

2008-2016

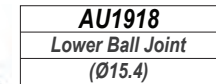
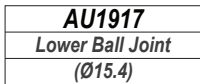
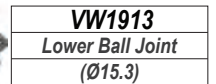
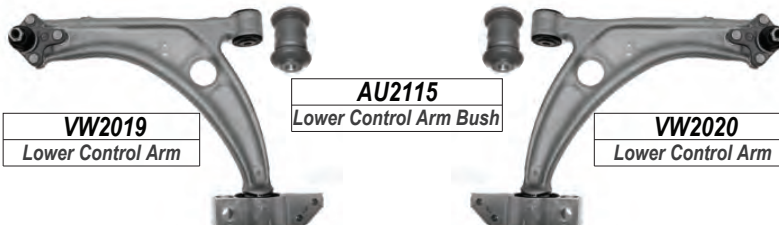
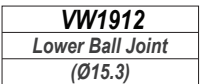
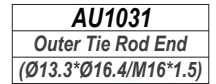
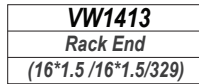
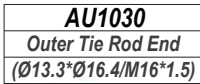
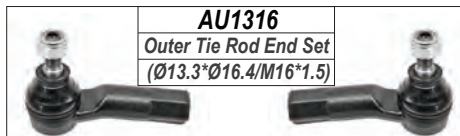

TIGUAN

REAR

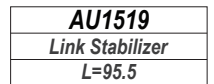
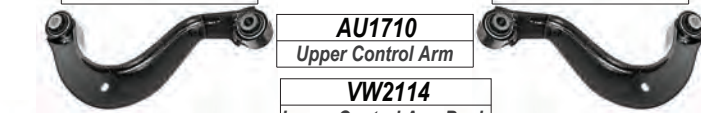
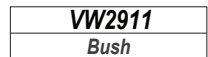
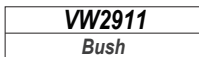
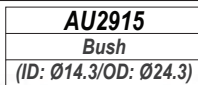

LEFT

RIGHT

**VOLKSWAGEN**

TIGUAN

FRONT

ALL MODELS

Year

2016-

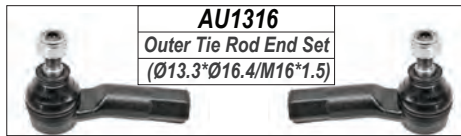

**AU1316**  
Outer Tie Rod End Set  
(Ø13.3\*Ø16.4/M16\*1.5)

**AU1030**  
Outer Tie Rod End  
(Ø13.3\*Ø16.4/M16\*1.5)

**AU1413**  
Rack End  
(16\*1.5 /16\*1.5/309)

**AU1031**  
Outer Tie Rod End  
(Ø13.3\*Ø16.4/M16\*1.5)



**AU1518**  
Link Stabilizer  
L=335



**AU1520**  
Link Stabilizer  
L=335



**AU1917**  
Lower Ball Joint  
(Ø15.4)



**AU2115**  
Lower Control Arm Bush



**AU1918**  
Lower Ball Joint  
(Ø15.4)



**VW2038**  
Lower Control Arm



**VW2039**  
Lower Control Arm



**AU2826**  
Shock Mounting



**AU2826**  
Shock Mounting



**AU2134**  
Lower Control Arm Bush



TIGUAN

REAR



**VW1712**  
Upper Control Arm



**VW1712**  
Upper Control Arm

**VW2114**  
Lower Control Arm Bush



**VW2014**  
Lower Control Arm



**VW2014**  
Lower Control Arm



LEFT

RIGHT



**VOLKSWAGEN**

TOUAREG

FRONT

ALL MODELS

Year

2002-2010

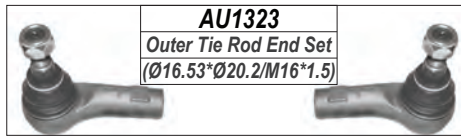

**AU1323**  
Outer Tie Rod End Set  
(Ø16.53\*Ø20.2/M16\*1.5)

**AU1035**  
Outer Tie Rod End  
(Ø16.53\*Ø20.2/M16\*1.5)



**AU1419**  
Rack End  
(16\*1.5/16\*1.5/291)



**AU1036**  
Outer Tie Rod End  
(Ø16.53\*Ø20.2/M16\*1.5)



**AU1540**  
Link Stabilizer  
L=197



**AU1813**  
Upper Control Arm Bush

**AU1731**  
Upper Control Arm



**AU1731**  
Upper Control Arm



**AU2135**  
Lower Control Arm Bush



**AU2136**  
Lower Control Arm Bush



**AU2136**  
Lower Control Arm Bush



**AU2070**  
Lower Control Arm



**AU2137**  
Lower Control Arm Bush



**AU2071**  
Lower Control Arm



**AU2136**  
Lower Control Arm Bush



**AU2138**  
Lower Control Arm Bush



**AU2136**  
Lower Control Arm Bush



**AU2072**  
Lower Control Arm



**AU2073**  
Lower Control Arm



**AU2827**  
Shock Mounting



**AU2137**  
Lower Control Arm Bush



**AU2827**  
Shock Mounting



LEFT

RIGHT



**VOLKSWAGEN**

**TOUAREG**

**REAR**

**ALL MODELS**

*Year*

**2002-2010**

**AU1541 / AU1542**  
Link Stabilizer  
L=201



**AU1543 / AU1544**  
Link Stabilizer  
L=200



**AU2811**  
Bush  
(ID:12.2/OD:Ø40)

**AU2813**  
Bush  
(ID:12.2/OD:Ø40)



**AU2813**  
Bush  
(ID:12.2/OD:Ø40)

**AU2616**  
Lateral Link

**AU2616**  
Lateral Link

**AU2812**  
Bush  
(ID:16.2/OD:Ø44.3)

**AU2813**  
Bush  
(ID:12.2/OD:Ø40)



**AU2813**  
Bush  
(ID:12.2/OD:Ø40)

**AU2617**  
Lateral Link

**AU2618**  
Lateral Link

**AU2827**  
Shock Mounting



**AU2827**  
Shock Mounting



**LEFT**

**RIGHT**

**VOLKSWAGEN**

**TOUAREG**

**FRONT**

**ALL MODELS**

**Year**

**2010-**

**AU1035**  
Outer Tie Rod End  
(Ø16.53\*Ø20.2/M16\*1.5)

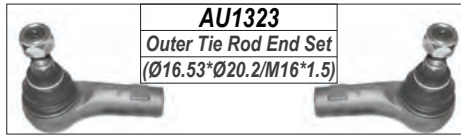

**AU1323**  
Outer Tie Rod End Set  
(Ø16.53\*Ø20.2/M16\*1.5)

**AU1036**  
Outer Tie Rod End  
(Ø16.53\*Ø20.2/M16\*1.5)



**AU1419**  
Rack End  
(16\*1.5 / 16\*1.5/291)



**PO1810**  
Upper Control Arm Bush



**PO1710**  
Upper Control Arm

**PO1710**  
Upper Control Arm

**AU2138**  
Lower Control Arm Bush

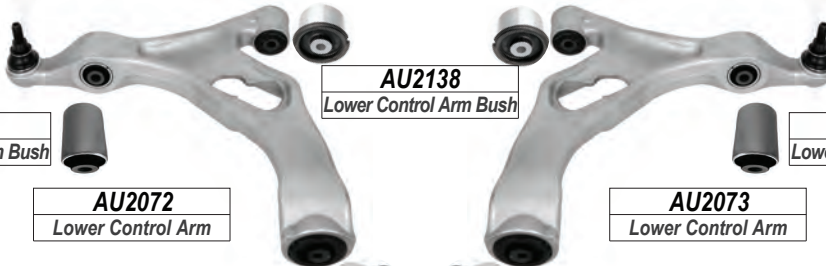

**AU2136**  
Lower Control Arm Bush

**AU2136**  
Lower Control Arm Bush

**AU2828**  
Shock Mounting



**AU2072**  
Lower Control Arm

**AU2073**  
Lower Control Arm

**AU2828**  
Shock Mounting



**AU2137**  
Lower Control Arm Bush

**AU2812**  
Bush  
(ID:16.2/OD:Ø44.3)

**TOUAREG**

**REAR**

**AU2813**  
Bush  
(ID:12.2/OD:Ø40)



**AU2813**  
Bush  
(ID:12.2/OD:Ø40)

**AU2617**  
Lateral Link

**AU2618**  
Lateral Link



**AU1540**  
Link Stabilizer  
L=197



**AU2828**  
Shock Mounting



**AU1541 / AU1542**  
Link Stabilizer  
L=201



**AU2828**  
Shock Mounting



**AU1543 / AU1544**  
Link Stabilizer  
L=200



**LEFT**

**RIGHT**

**VOLKSWAGEN**

**TOURAN**

**FRONT**

**ALL MODELS**

**Year**

**2004-**

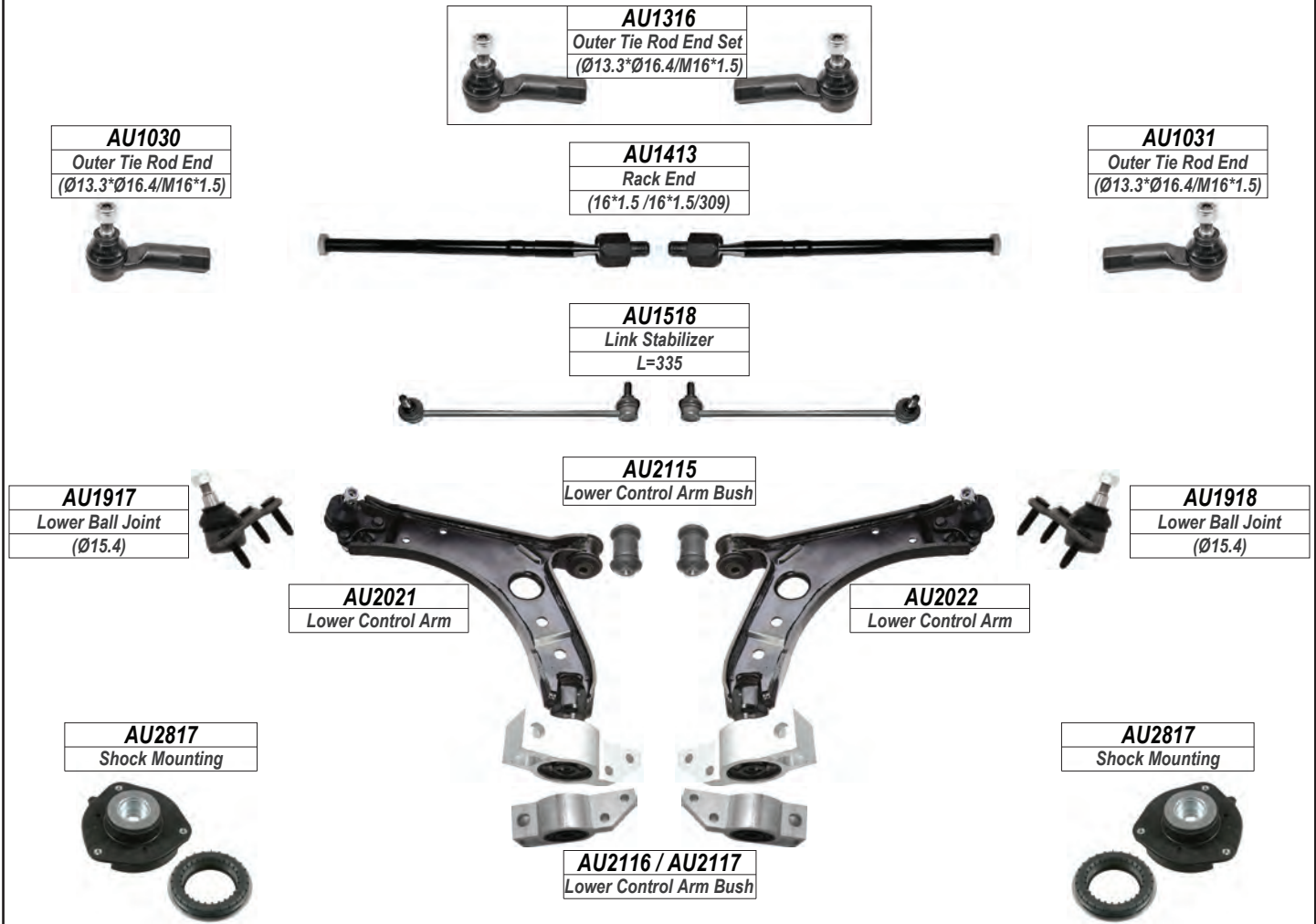

**TOURAN**

**REAR**



**LEFT**

**RIGHT**

**VOLKSWAGEN**

UP

FRONT

ALL MODELS

Year

2015-

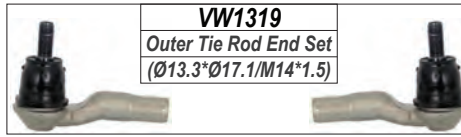

**VW1319**  
Outer Tie Rod End Set  
(Ø13.3\*Ø17.1/M14\*1.5)

**VW1029**  
Outer Tie Rod End  
(Ø13.3\*Ø17.1/M14\*1.5)

**VW1412**  
Rack End  
(16\*1.5 /16\*1.5/291)

**VW1030**  
Outer Tie Rod End  
(Ø13.3\*Ø17.1/M14\*1.5)



**AU1511**  
Link Stabilizer  
L=271



**AU1913**  
Lower Ball Joint  
(Ø14.9)

**AU2113**  
Lower Control Arm Bush

**AU1914**  
Lower Ball Joint  
(Ø14.9)



**VW2044**  
Lower Control Arm

**VW2045**  
Lower Control Arm

**AU2814**  
Shock Mounting

**AU2814**  
Shock Mounting



**AU2114**  
Lower Control Arm Bush



LEFT

RIGHT



**VOLVO**

850

FRONT

ALL MODELS

Year

1994-1997

**VO1010**  
Outer Tie Rod End  
(Ø12.93\*Ø16.1/M14\*2)



**VO1310**  
Outer Tie Rod End Set  
(Ø12.93\*Ø16.1/M14\*2)

**VO1011**  
Outer Tie Rod End  
(Ø12.93\*Ø16.1/M14\*2)



**VO1410**  
Rack End  
(14\*1.5/14\*2/177)



**VO1510**  
Link Stabilizer  
L=302



**VO2110**  
Lower Control Arm Bush



**VO2010**  
Lower Control Arm



**VO2011**  
Lower Control Arm



**VO1910**  
Lower Ball Joint  
(Ø19)



**VO1910**  
Lower Ball Joint  
(Ø19)



**VO2111**  
Lower Control Arm Bush

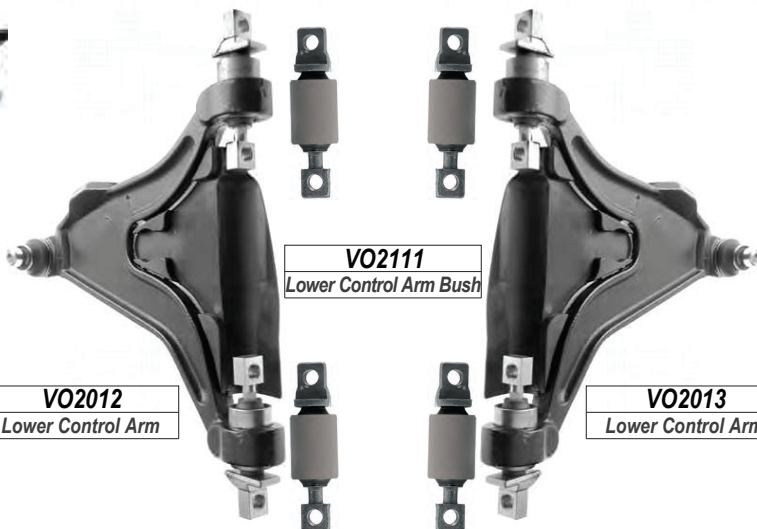

**VO2012**  
Lower Control Arm



**VO2013**  
Lower Control Arm



LEFT

RIGHT



**VOLVO**

960

FRONT

ALL MODELS

Year

1994-1997

**VO1010**  
Outer Tie Rod End  
(Ø12.93\*Ø16.1/M14\*2)

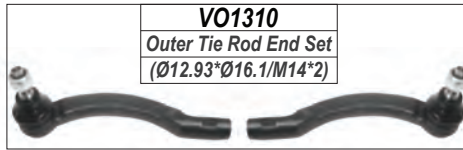

**VO1310**  
Outer Tie Rod End Set  
(Ø12.93\*Ø16.1/M14\*2)

**VO1011**  
Outer Tie Rod End  
(Ø12.93\*Ø16.1/M14\*2)



**VO1411**  
Rack End  
(14\*1.5/14\*2/288)



**VO1511**  
Link Stabilizer  
L=245



**VO1911**  
Lower Ball Joint  
(Ø15.5)



**VO1911**  
Lower Ball Joint  
(Ø15.5)



LEFT

RIGHT

**VOLVO**

**C30**

**FRONT**

**ALL MODELS**

*Year*

**2006-2013**

**FO1041**  
Outer Tie Rod End  
(Ø12.3\*Ø16/M16\*1.5)

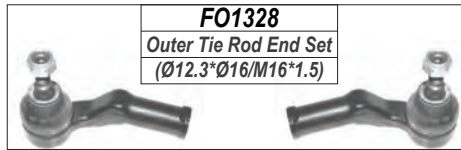

**FO1328**  
Outer Tie Rod End Set  
(Ø12.3\*Ø16/M16\*1.5)

**FO1042**  
Outer Tie Rod End  
(Ø12.3\*Ø16/M16\*1.5)



**FO1430**  
Rack End  
(14\*1.5/16\*1.5/293)



**FO1518**  
Link Stabilizer  
L=298



**MA2110**  
Lower Control Arm Bush

**FO1921**  
Lower Ball Joint  
(Ø19)



**FO1921**  
Lower Ball Joint  
(Ø19)

**FO2041**  
Lower Control Arm

**FO2042**  
Lower Control Arm

**FO2127**  
Lower Control Arm Bush

**FO1922**  
Lower Ball Joint  
(Ø21)



**FO1922**  
Lower Ball Joint  
(Ø21)

**FO2043**  
Lower Control Arm

**FO2044**  
Lower Control Arm

**FO2127**  
Lower Control Arm Bush

**FO2826**  
Shock Mounting



**FO2826**  
Shock Mounting



**LEFT**

**RIGHT**

**VOLVO**

**C30**

**REAR**

**ALL MODELS**

*Year*

**2006-2013**

**FO1519**  
Link Stabilizer  
L=110



**FO1520**  
Link Stabilizer  
L=76



**FO1521**  
Link Stabilizer  
L=109



**FO2126**  
Lower Control Arm Bush



**FO2040**  
Lower Control Arm

**FO2040**  
Lower Control Arm



**FO2045**  
Lower Control Arm



**FO2045**  
Lower Control Arm

**FO2911**  
Bush

**FO2911**  
Bush



**FO2911**  
Bush

**FO2613**  
Lateral Link  
L=223

**FO2613**  
Lateral Link  
L=223

**FO2910**  
Bush



**LEFT**

**RIGHT**

**VOLVO**

C70

FRONT

Year

1998-2006

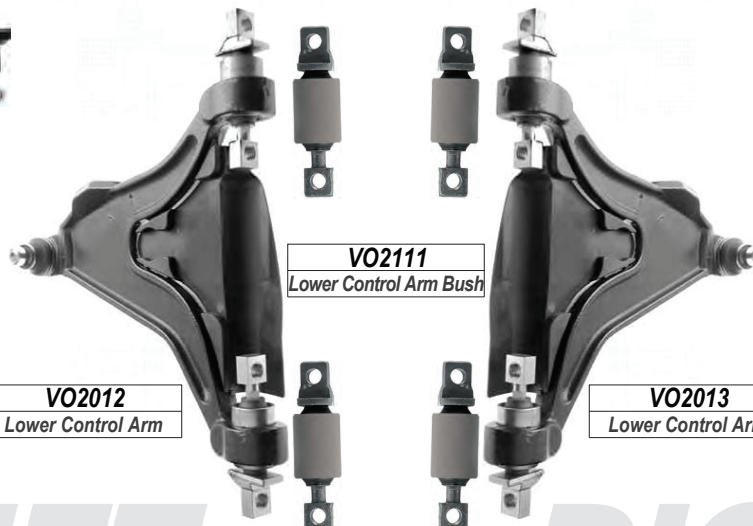
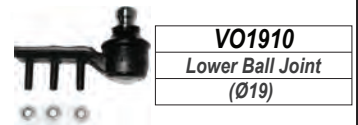
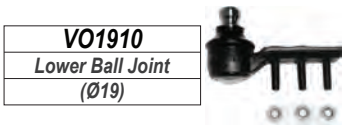
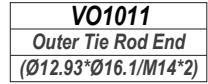
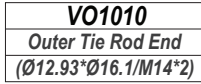
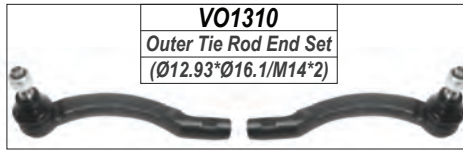

**LEFT**

**RIGHT**

**VOLVO**

C70

FRONT

II

Year

2006-2013

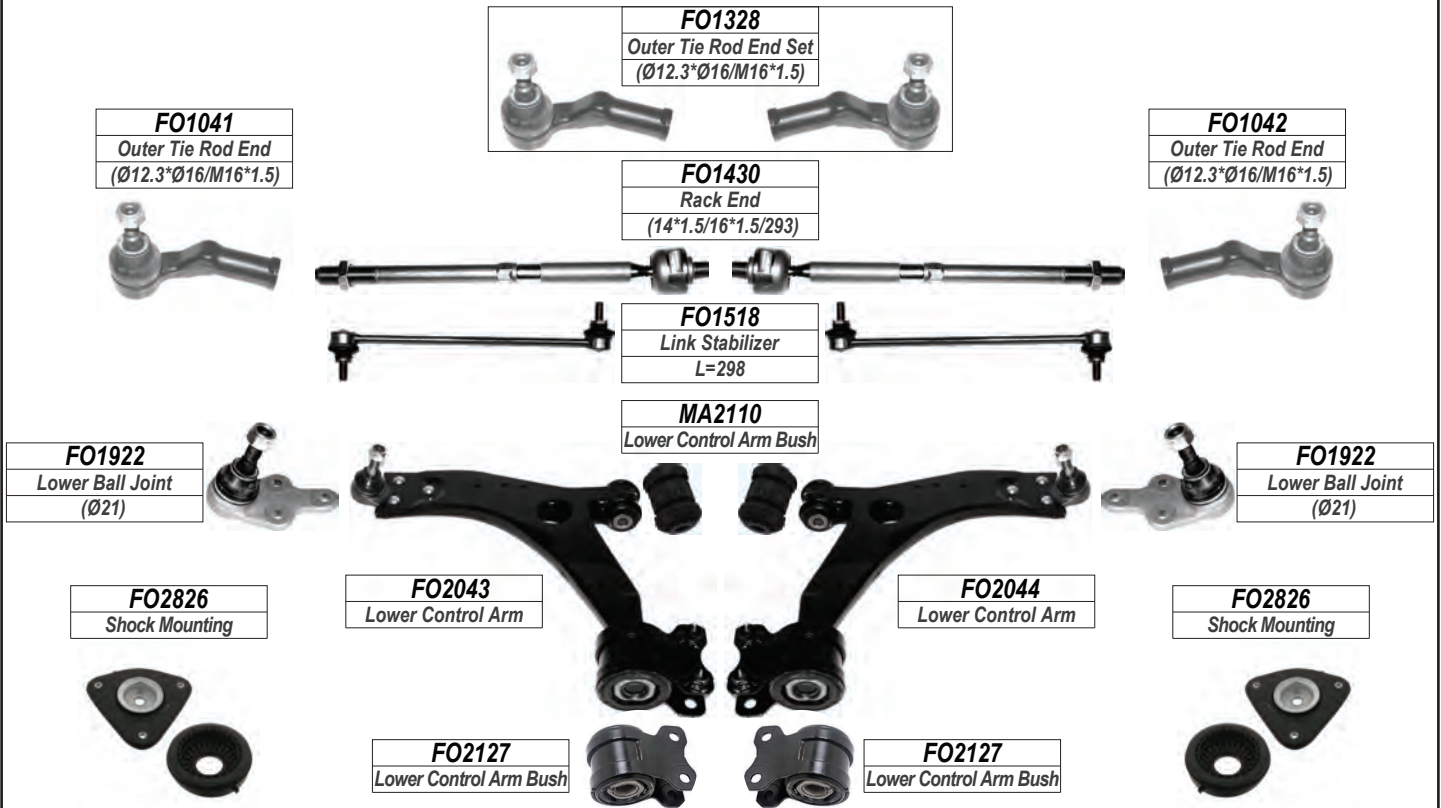

C70

REAR

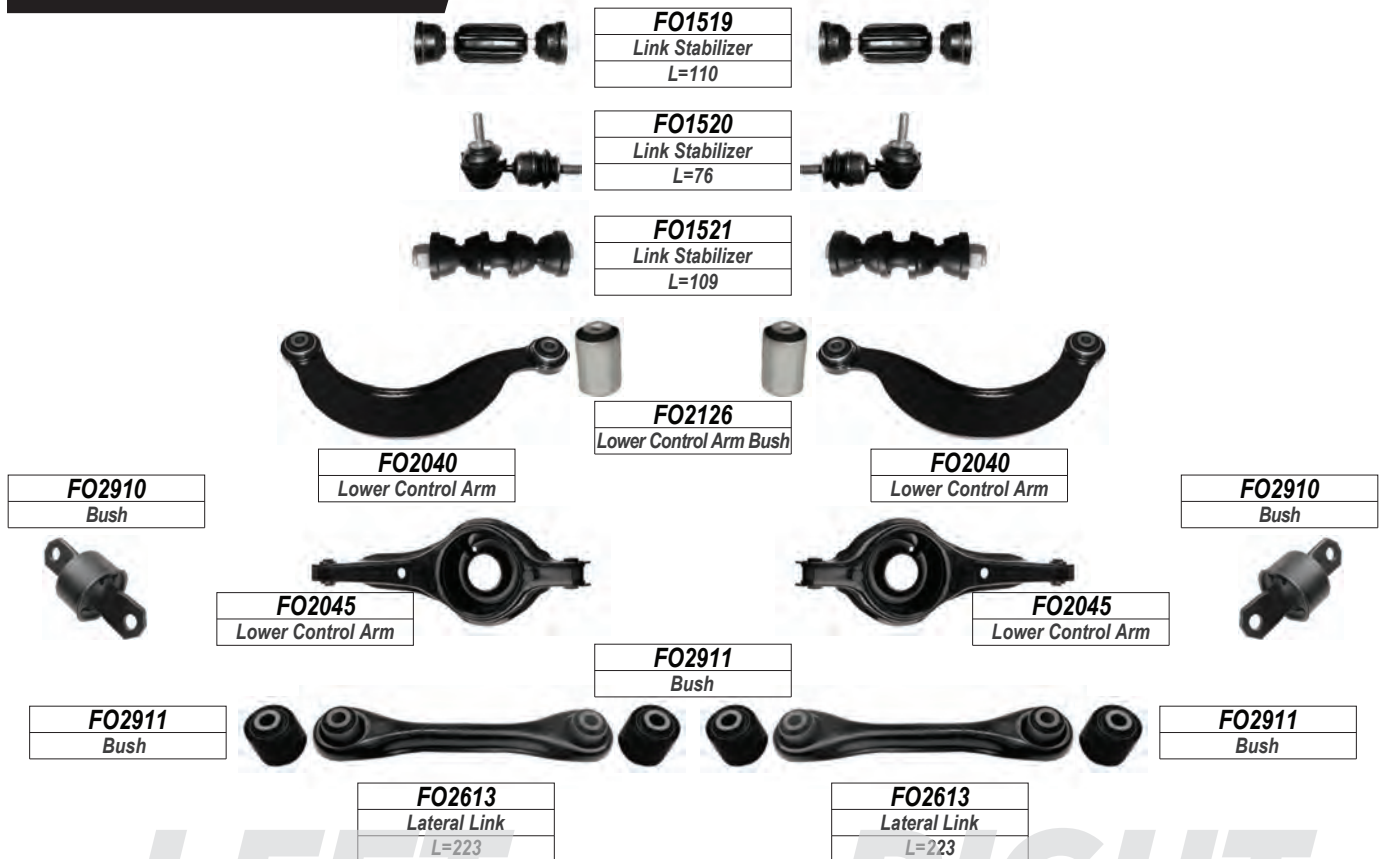

LEFT

RIGHT



**VOLVO**

S40 / V40

FRONT

Year

1997-2004

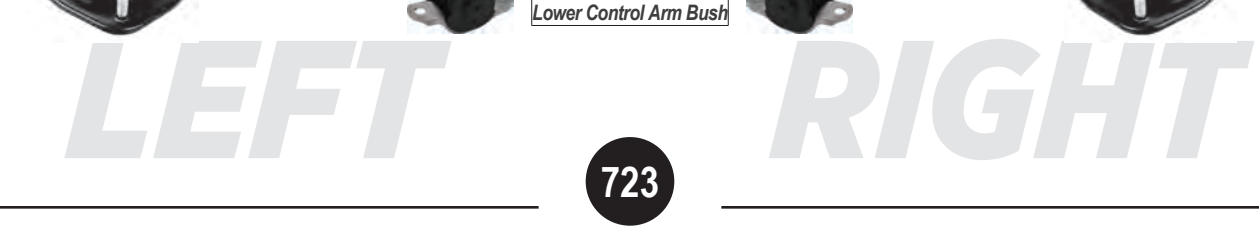
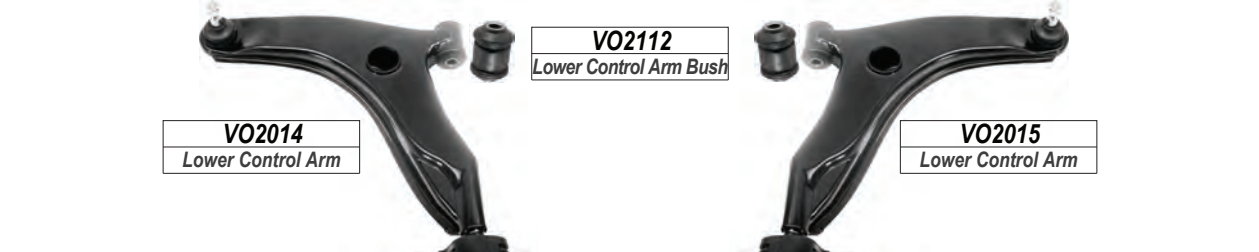
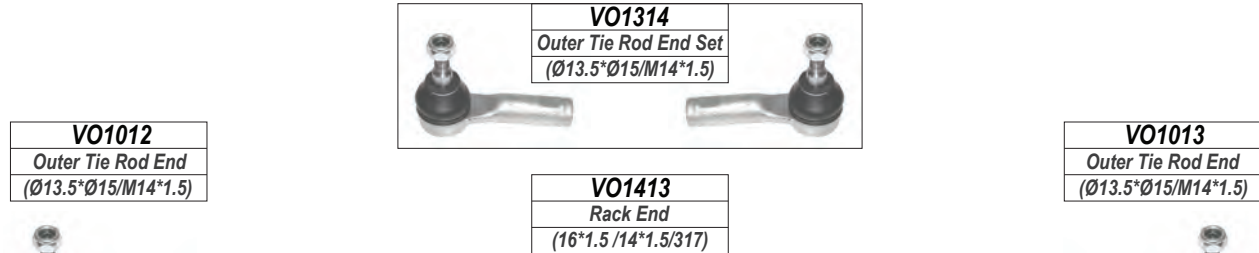

**LEFT**

**RIGHT**

**VOLVO**

S40 / V40

REAR

Year

1997-2004

I

**VO1514**  
Link Stabilizer  
L=105.5



**VO2611**  
Lateral Link  
L=143



**VO2610**  
Lateral Link  
L=257



**MI2020**  
Lower Control Arm



**MI2021**  
Lower Control Arm

**LEFT**

**RIGHT**

**VOLVO**

S40 / V50

FRONT

II

Year

2004-2009

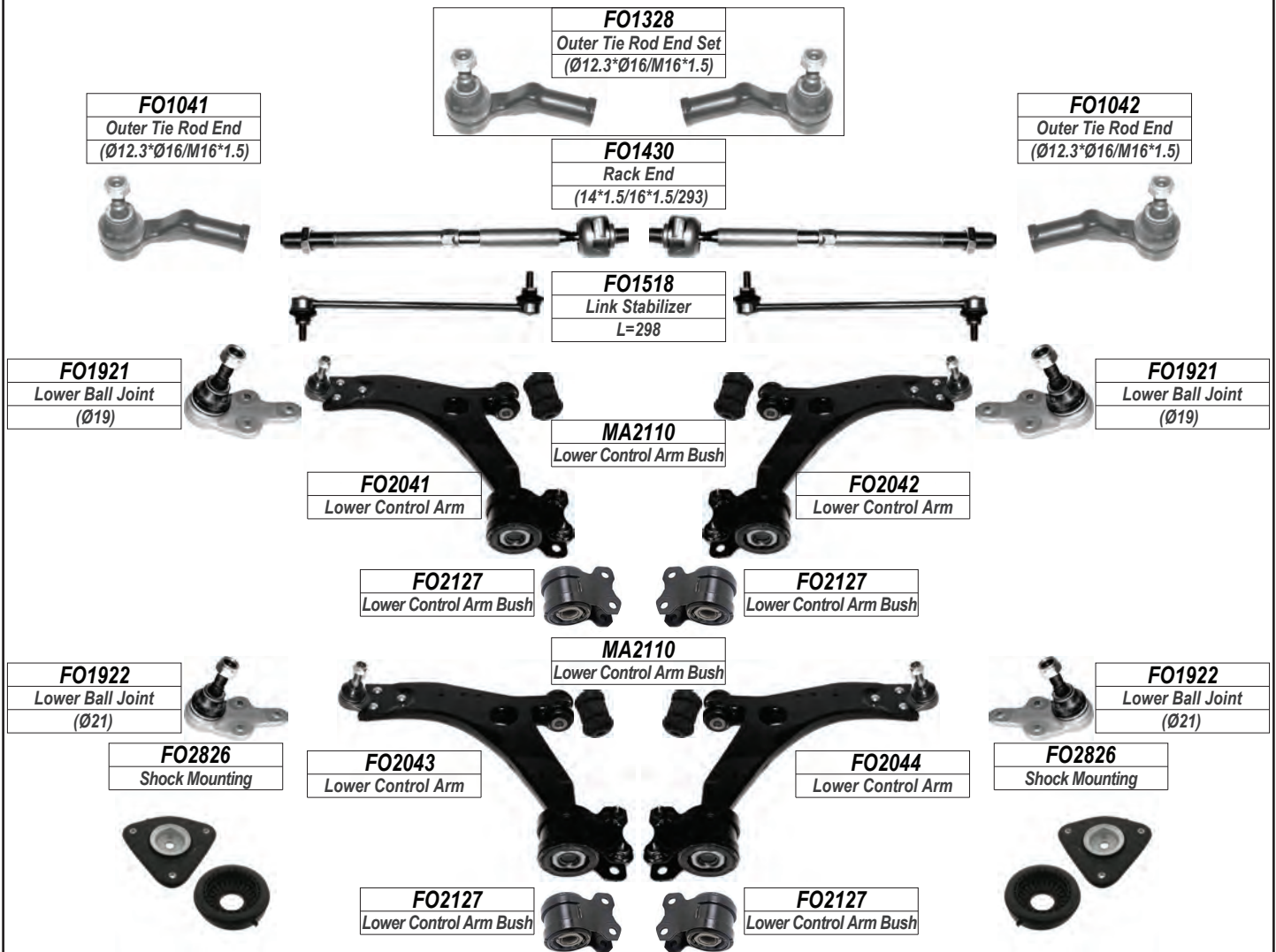

S40 / V50

REAR



LEFT

RIGHT

**VOLVO**

S60

FRONT

Year

2001-2010

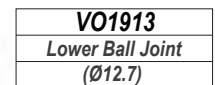
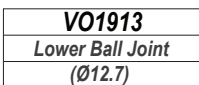
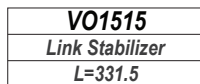
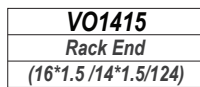
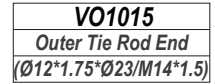
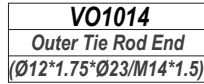
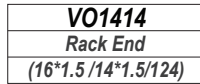

S60

REAR

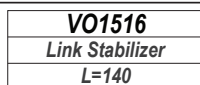

LEFT

RIGHT



**VOLVO**

S60

FRONT

II

Year

2010-

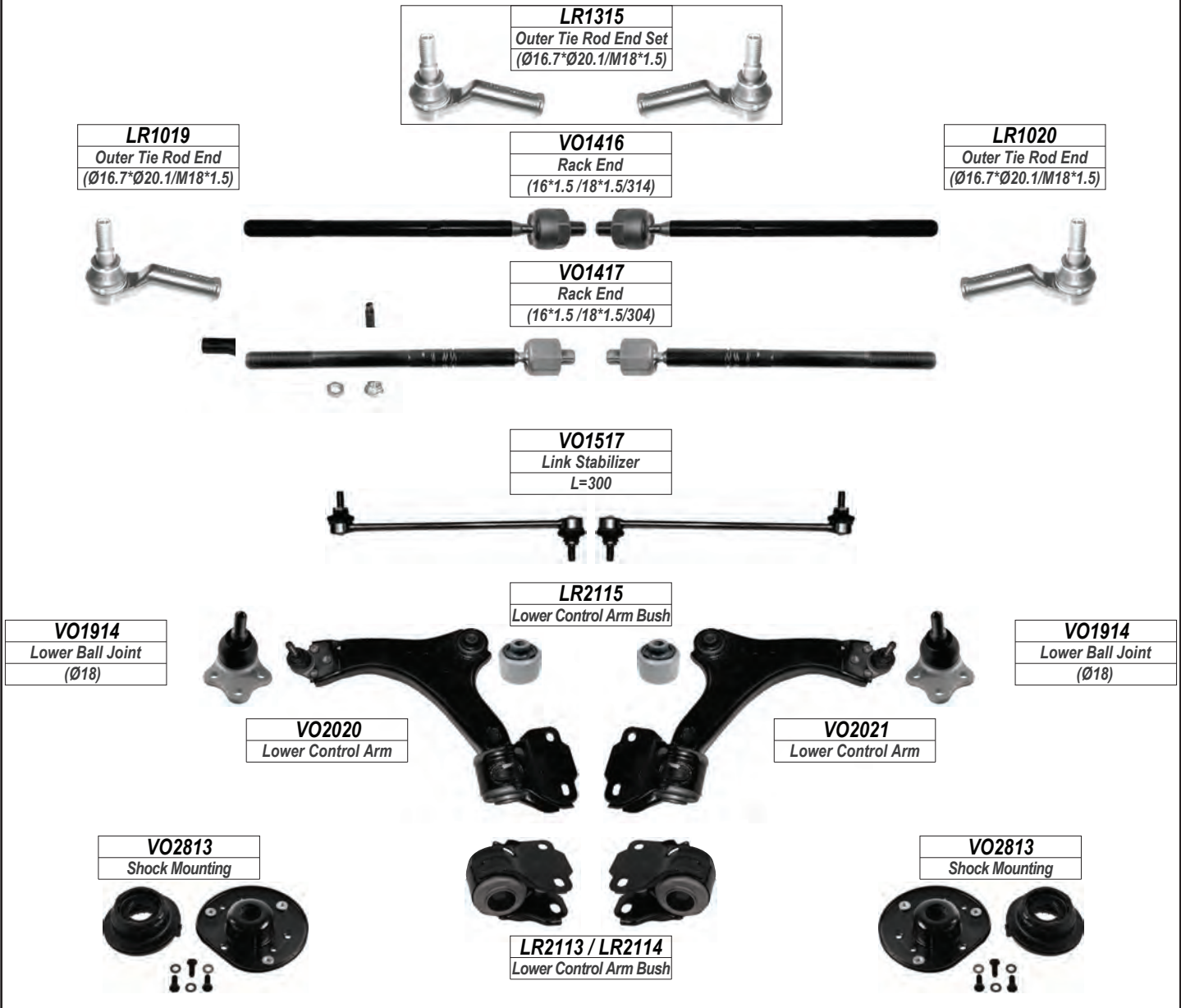

S60

REAR

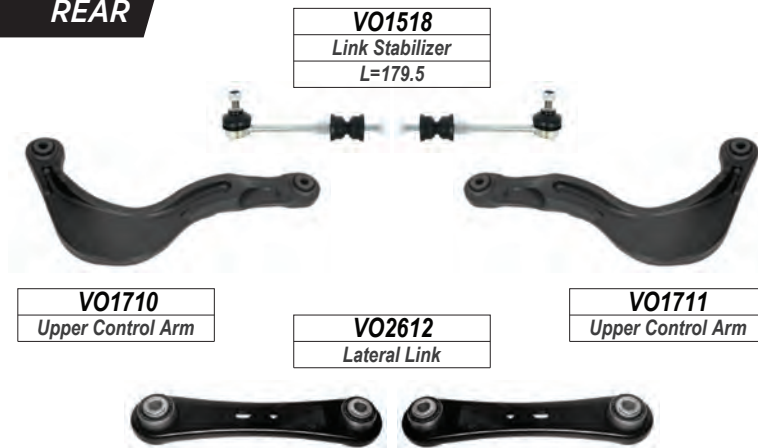

LEFT

RIGHT



**VOLVO**

**S70**

**FRONT**

**ALL MODELS**

*Year*

**1997-2000**

**VO1010**  
Outer Tie Rod End  
(Ø12.93\*Ø16.1/M14\*2)



**VO1310**  
Outer Tie Rod End Set  
(Ø12.93\*Ø16.1/M14\*2)

**VO1011**  
Outer Tie Rod End  
(Ø12.93\*Ø16.1/M14\*2)



**VO1410**  
Rack End  
(14\*1.5/14\*2/177)



**VO1510**  
Link Stabilizer  
L=302

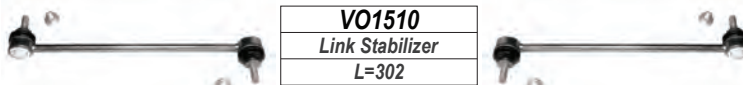

**VO2110**  
Lower Control Arm Bush



**VO2010**  
Lower Control Arm



**VO2011**  
Lower Control Arm



**VO1910**  
Lower Ball Joint  
(Ø19)



**VO1910**  
Lower Ball Joint  
(Ø19)



**VO2111**  
Lower Control Arm Bush

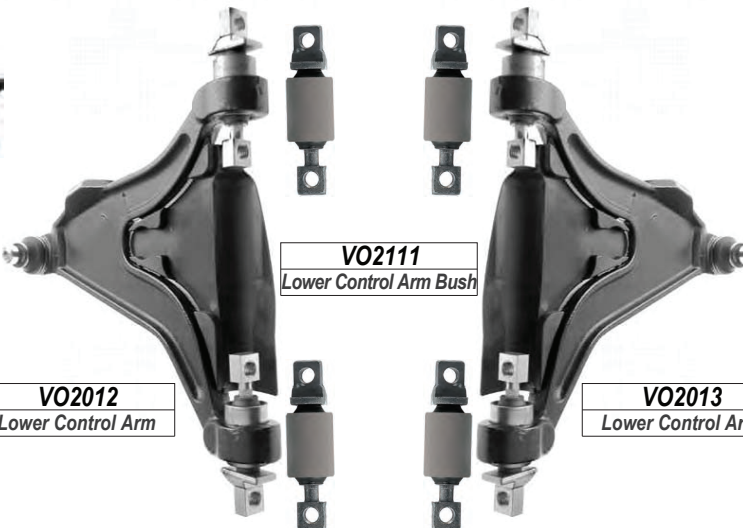

**VO2012**  
Lower Control Arm



**VO2013**  
Lower Control Arm



**VO2814**  
Shock Mounting



**VO2815**  
Shock Mounting



**VO2814**  
Shock Mounting



**VO2815**  
Shock Mounting



**LEFT**

**RIGHT**

**VOLVO**

S80

FRONT

Year

1999-2006



<b>VO1014</b>
Outer Tie Rod End
(Ø12*1.75*Ø23/M14*1.5)



<b>VO1414</b>
Rack End
(16*1.5/14*1.5/124)



<b>VO1015</b>
Outer Tie Rod End
(Ø12*1.75*Ø23/M14*1.5)



<b>VO1415</b>
Rack End
(16*1.5/14*1.5/124)



<b>VO1016</b>
Outer Tie Rod End
(Ø13.6*Ø16.6/M14*2)



<b>VO1418</b>
Rack End
(16*1.5/14*2.0/131)



<b>VO1017</b>
Outer Tie Rod End
(Ø13.6*Ø16.6/M14*2)



<b>VO1515</b>
Link Stabilizer
L=331.5



<b>VO1913</b>
Lower Ball Joint
(Ø12.7)



<b>VO2022</b>
Lower Control Arm



<b>VO2023</b>
Lower Control Arm

<b>VO1913</b>
Lower Ball Joint
(Ø12.7)



S80

REAR

<b>VO1516</b>
Link Stabilizer
L=140



LEFT

RIGHT

**VOLVO**

S80

FRONT

Year

2006-

II

**LR1019**  
Outer Tie Rod End  
(Ø16.7\*Ø20.1/M18\*1.5)



**LR1315**  
Outer Tie Rod End Set  
(Ø16.7\*Ø20.1/M18\*1.5)

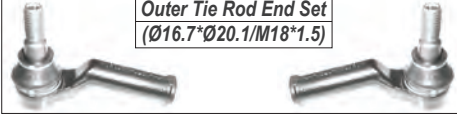

**VO1416**  
Rack End  
(16\*1.5 / 18\*1.5/314)



**LR1020**  
Outer Tie Rod End  
(Ø16.7\*Ø20.1/M18\*1.5)



**VO1417**  
Rack End  
(16\*1.5 / 18\*1.5/304)



**VO1517**  
Link Stabilizer  
L=300



**LR2115**  
Lower Control Arm Bush

**VO1914**  
Lower Ball Joint  
(Ø18)



**VO2020**  
Lower Control Arm



**VO2021**  
Lower Control Arm



**VO1914**  
Lower Ball Joint  
(Ø18)

**VO2813**  
Shock Mounting



**LR2113 / LR2114**  
Lower Control Arm Bush



**VO2813**  
Shock Mounting



S80

REAR

**VO1518**  
Link Stabilizer  
L=179.5



LEFT

RIGHT

**VOLVO**

S90 / V90

FRONT

ALL MODELS

Year

1997-2000

**VO1014**  
Outer Tie Rod End  
(Ø12\*1.75\*Ø23/M14\*1.5)



**VO1311**  
Outer Tie Rod End Set  
(Ø12\*1.75\*Ø23/M14\*1.5)

**VO1411**  
Rack End  
(14\*1.5/14\*2/224)



**VO1015**  
Outer Tie Rod End  
(Ø12\*1.75\*Ø23/M14\*1.5)



**VO1511**  
Link Stabilizer  
L=245



**VO1519**  
Link Stabilizer  
L=140



**VO1520**  
Link Stabilizer  
L=64



**VO1911**  
Lower Ball Joint  
(Ø15.5)



**VO1911**  
Lower Ball Joint  
(Ø15.5)



LEFT

RIGHT

**VOLVO**

V40

FRONT

ALL MODELS

Year

2013-

**VO1018**  
Outer Tie Rod End  
(Ø11.4\*Ø18/M16\*1.5)

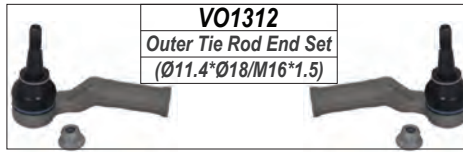

**VO1312**  
Outer Tie Rod End Set  
(Ø11.4\*Ø18/M16\*1.5)

**FO1431**  
Rack End  
(14\*1.5/16\*1.5/290)

**VO1019**  
Outer Tie Rod End  
(Ø11.4\*Ø18/M16\*1.5)



**VO1521**  
Link Stabilizer  
L=76.4

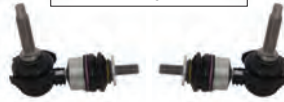

**FO2129**  
Lower Control Arm Bush

**VO1915**  
Lower Ball Joint  
(Ø21)

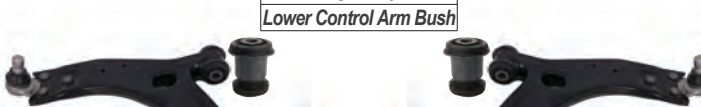

**VO1916**  
Lower Ball Joint  
(Ø21)



**VO2024**  
Lower Control Arm



**VO2025**  
Lower Control Arm



**FO2128**  
Lower Control Arm Bush



**VO2816**  
Shock Mounting



**VO2816**  
Shock Mounting



V40

REAR

**VO1523**  
Link Stabilizer  
L=50 (1.6)



LEFT

RIGHT



**VOLVO**

V50

FRONT

ALL MODELS

Year

2004-2013

**FO1041**  
Outer Tie Rod End  
(Ø12.3\*Ø16/M16\*1.5)

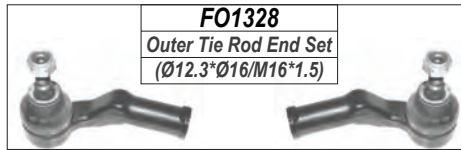

**FO1328**  
Outer Tie Rod End Set  
(Ø12.3\*Ø16/M16\*1.5)

**FO1430**  
Rack End  
(14\*1.5/16\*1.5/293)



**FO1042**  
Outer Tie Rod End  
(Ø12.3\*Ø16/M16\*1.5)



**FO1518**  
Link Stabilizer  
L=298



**MA2110**  
Lower Control Arm Bush

**FO1921**  
Lower Ball Joint  
(Ø19)



**FO2041**  
Lower Control Arm

**FO2042**  
Lower Control Arm

**FO1921**  
Lower Ball Joint  
(Ø19)



**FO2826**  
Shock Mounting



**FO2826**  
Shock Mounting



**FO2127**  
Lower Control Arm Bush



V50

REAR

**FO1519**  
Link Stabilizer  
L=110



**FO1520**  
Link Stabilizer  
L=76



**FO2910**  
Bush



**FO2040**  
Lower Control Arm



**FO2040**  
Lower Control Arm

LEFT

RIGHT

**VOLVO**

V60

FRONT

ALL MODELS

Year

2011-

**LR1019**  
Outer Tie Rod End  
(Ø16.7\*Ø20.1/M18\*1.5)



**LR1315**  
Outer Tie Rod End Set  
(Ø16.7\*Ø20.1/M18\*1.5)

**VO1416**  
Rack End  
(16\*1.5 /18\*1.5/314)



**LR1020**  
Outer Tie Rod End  
(Ø16.7\*Ø20.1/M18\*1.5)



**VO1417**  
Rack End  
(16\*1.5 /18\*1.5/304)



**VO1517**  
Link Stabilizer  
L=300



**LR2115**  
Lower Control Arm Bush

**VO1914**  
Lower Ball Joint  
(Ø18)



**VO2020**  
Lower Control Arm



**VO2021**  
Lower Control Arm



**VO1914**  
Lower Ball Joint  
(Ø18)

**VO2813**  
Shock Mounting



**LR2113 / LR2114**  
Lower Control Arm Bush



**VO2813**  
Shock Mounting



V60

REAR

**VO1518**  
Link Stabilizer  
L=179.5



LEFT

RIGHT

**VOLVO**

V70

FRONT

Year

1997-2000

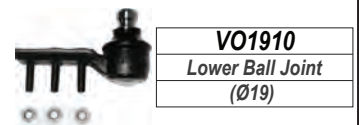
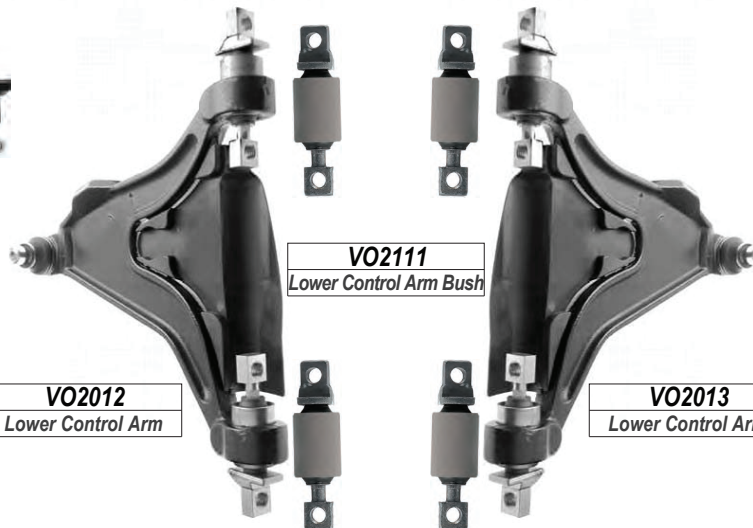
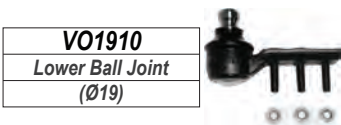
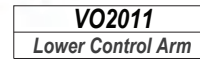
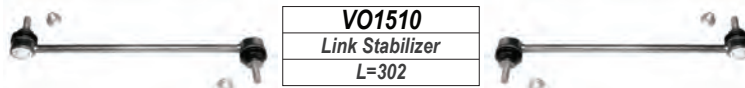
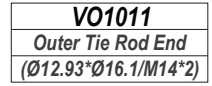
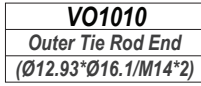

LEFT

RIGHT

**VOLVO**

V70

FRONT

II

Year

2000-2007

**VO1311**  
Outer Tie Rod End Set  
(Ø12\*1.75\*Ø23/M14\*1.5)



**VO1414**  
Rack End  
(16\*1.5/14\*1.5/124)



**VO1015**  
Outer Tie Rod End  
(Ø12\*1.75\*Ø23/M14\*1.5)



**VO1014**  
Outer Tie Rod End  
(Ø12\*1.75\*Ø23/M14\*1.5)



**VO1415**  
Rack End  
(16\*1.5/14\*1.5/124)



**VO1515**  
Link Stabilizer  
L=331.5

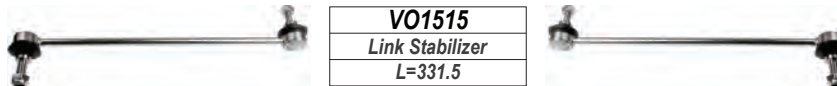

**VO1913**  
Lower Ball Joint  
(Ø12.7)



**VO1913**  
Lower Ball Joint  
(Ø12.7)



**VO2018**  
Lower Control Arm



**VO2019**  
Lower Control Arm



**VO2814**  
Shock Mounting



**VO2814**  
Shock Mounting



**VO2815**  
Shock Mounting



**VO2815**  
Shock Mounting



V70

REAR

**VO1516**  
Link Stabilizer  
L=140



LEFT

RIGHT

**VOLVO**

V70

FRONT

Year

2007-

III

**LR1019**  
Outer Tie Rod End  
(Ø16.7\*Ø20.1/M18\*1.5)



**LR1315**  
Outer Tie Rod End Set  
(Ø16.7\*Ø20.1/M18\*1.5)

**VO1416**  
Rack End  
(16\*1.5 /18\*1.5/314)



**LR1020**  
Outer Tie Rod End  
(Ø16.7\*Ø20.1/M18\*1.5)



**VO1417**  
Rack End  
(16\*1.5 /18\*1.5/304)



**VO1517**  
Link Stabilizer  
L=300



**LR2115**  
Lower Control Arm Bush

**VO1914**  
Lower Ball Joint  
(Ø18)



**VO2020**  
Lower Control Arm



**VO2021**  
Lower Control Arm

**VO1914**  
Lower Ball Joint  
(Ø18)



**LR2113 / LR2114**  
Lower Control Arm Bush



V70

REAR

**VO1518**  
Link Stabilizer  
L=179.5



LEFT

RIGHT



**VOLVO**

**XC60**

**FRONT**

**ALL MODELS**

*Year*

**2008-**

**LR1019**  
Outer Tie Rod End  
(Ø16.7\*Ø20.1/M18\*1.5)



**LR1315**  
Outer Tie Rod End Set  
(Ø16.7\*Ø20.1/M18\*1.5)

**VO1419**  
Rack End  
(16\*1.5/18\*1.5/318)



**VO1420**  
Rack End  
(16\*1.5/18\*1.5/331)



**LR1020**  
Outer Tie Rod End  
(Ø16.7\*Ø20.1/M18\*1.5)



**VO1517**  
Link Stabilizer  
L=300



**LR2115**  
Lower Control Arm Bush

**VO1917**  
Lower Ball Joint  
(Ø22)



**VO2026**  
Lower Control Arm

**VO2027**  
Lower Control Arm

**VO1917**  
Lower Ball Joint  
(Ø22)

**LR2113 / LR2114**  
Lower Control Arm Bush

**V70**

**REAR**

**VO1518**  
Link Stabilizer  
L=179.5

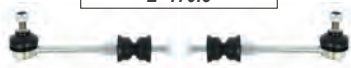

**LEFT**

**RIGHT**

**VOLVO**

**XC70**

**FRONT**

**ALL MODELS**

*Year*

**2000-2007**

**VO1014**  
Outer Tie Rod End  
(Ø12\*1.75\*Ø23/M14\*1.5)



**VO1311**  
Outer Tie Rod End Set  
(Ø12\*1.75\*Ø23/M14\*1.5)

**VO1015**  
Outer Tie Rod End  
(Ø12\*1.75\*Ø23/M14\*1.5)



**VO1414**  
Rack End  
(16\*1.5 / 14\*1.5/124)



**VO1313**  
Outer Tie Rod End Set  
(Ø15\*Ø33/M14\*1.5)

**VO1020**  
Outer Tie Rod End  
(Ø15\*Ø33/M14\*1.5)



**VO1415**  
Rack End  
(16\*1.5 / 14\*1.5/124)



**VO1021**  
Outer Tie Rod End  
(Ø15\*Ø33/M14\*1.5)

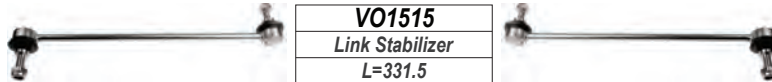

**VO1515**  
Link Stabilizer  
L=331.5

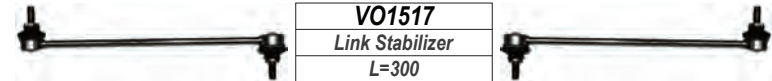

**VO1517**  
Link Stabilizer  
L=300

**VO2116**  
Lower Control Arm



**VO1913**  
Lower Ball Joint  
(Ø12.7)



**VO1913**  
Lower Ball Joint  
(Ø12.7)



**VO2028**  
Lower Control Arm

**VO2029**  
Lower Control Arm

**VO2814**  
Shock Mounting



**VO2115**  
Lower Control Arm

**VO2814**  
Shock Mounting



**VO2815**  
Shock Mounting



**VO2815**  
Shock Mounting



**LEFT**

**RIGHT**

**VOLVO**

**XC70**

**FRONT**

**ALL MODELS**

*Year*

**2007-**

**LR1019**  
Outer Tie Rod End  
(Ø16.7\*Ø20.1/M18\*1.5)



**LR1315**  
Outer Tie Rod End Set  
(Ø16.7\*Ø20.1/M18\*1.5)

**VO1416**  
Rack End  
(16\*1.5 / 18\*1.5/314)



**LR1020**  
Outer Tie Rod End  
(Ø16.7\*Ø20.1/M18\*1.5)



**VO1517**  
Link Stabilizer  
L=300



**LR2115**  
Lower Control Arm Bush

**VO1917**  
Lower Ball Joint  
(Ø22)



**VO2026**  
Lower Control Arm

**VO2027**  
Lower Control Arm

**VO1917**  
Lower Ball Joint  
(Ø22)



**LR2113 / LR2114**  
Lower Control Arm Bush

**VO2813**  
Shock Mounting



**VO2813**  
Shock Mounting



**XC70**

**REAR**

**VO1518**  
Link Stabilizer  
L=179.5

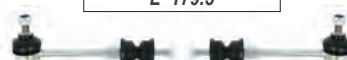

**LEFT**

**RIGHT**

**VOLVO**

**XC90**

**FRONT**

**ALL MODELS**

*Year*

**2003-2014**

**VO1313**  
Outer Tie Rod End Set  
(Ø12\*Ø33/M14\*1.5)

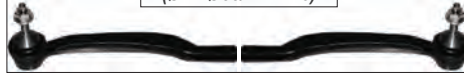

**VO1414**  
Rack End  
(16\*1.5 / 14\*1.5/124)



**VO1020**  
Outer Tie Rod End  
(Ø12\*Ø33/M14\*1.5)



**VO1021**  
Outer Tie Rod End  
(Ø12\*Ø33/M14\*1.5)



**VO1415**  
Rack End  
(16\*1.5 / 14\*1.5/124)



**VO1515**  
Link Stabilizer  
L=331.5

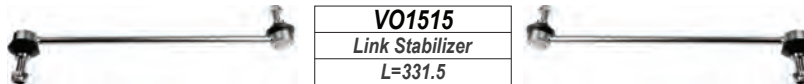

**VO2117**  
Lower Control Arm Bush



**VO1918**  
Lower Ball Joint  
(Ø14.74)



**VO1918**  
Lower Ball Joint  
(Ø14.74)



**VO2030**  
Lower Control Arm

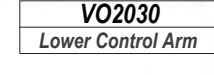

**VO2031**  
Lower Control Arm

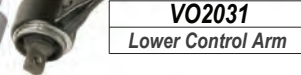

**VO2811**  
Shock Mounting



**VO2811**  
Shock Mounting



**VO2118**  
Lower Control Arm Bush



**VO2812**  
Shock Mounting



**VO2812**  
Shock Mounting



**XC90**

**REAR**

**VO1516**  
Link Stabilizer  
L=140



**LEFT**

**RIGHT**



**teknosa**<sup>®</sup>

STEERING & SUSPENSION PARTS

✉ [info@teknosa.co.za](mailto:info@teknosa.co.za)

🌐 [www.teknosa.co.za](http://www.teknosa.co.za)



**2020/21**

**STEERING & SUSPENSION  
PARTS CATALOGUE**  
FOR PASSENGER & LIGHT COMMERCIAL VEHICLES

