

2022/23

STEERING & SUSPENSION PARTS CATALOGUE

FOR PASSENGER & LIGHT COMMERCIAL VEHICLES



 **teknosa**[®]
STEERING & SUSPENSION PARTS

www.teknosa.co.za

ABOUT US

Teknosa Automotive is one of the leading suppliers of Automotive Spare Parts in Southern Africa. Our product range is by far the most extensive. our range extends to all vehicles in SADC countries.

We are constantly developing new applications, to meet the demands of the aftermarket industry which is a key success factor for driving our growth.

ABOUT OUR PRODUCT

Our attention to even the smallest detail has made our brand synonymous with Quality & Reliability, making our brand the most popular, by choice.

BRAND QUALITY

Our Automotive Spare Parts are engineered and manufactured in accordance with the highest quality manufacturing standards. All Teknosa Steering and Suspension Parts are manufactured by ISO/TS 16949 and ISO 14001 accredited manufacturers. Our state of the art production facilities feature technologically advanced, ultra-precision equipment and integrated operations to deliver our brand of quality Automotive Spare Parts for most vehicle applications.

DISCLAIMER

The information listed here-in have been compiled to the best of our knowledge and from reliable sources and, is for reference and guide purposes only. Teknosa Automotive cannot be held responsible for errors and interpretation. E&OE

WARRANTY

Our brand is sold with a 12-month warranty against manufacturing defects and malfunction, provided that our product is fitted by accredited fitment centres and qualified technicians. This warranty does not extend to normal wear & tear, neglect and damage.

“The Contents of this catalogue are protected by copyright. Unlawful use of the contents will result in prosecution.”

All Teknosa Suspension Parts listed, sold or supplied is offered and sold as replacement parts only.

CATALOGUE IDENTIFICATION

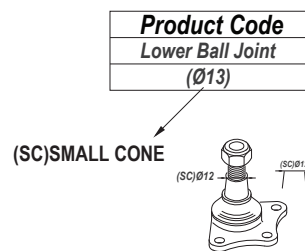
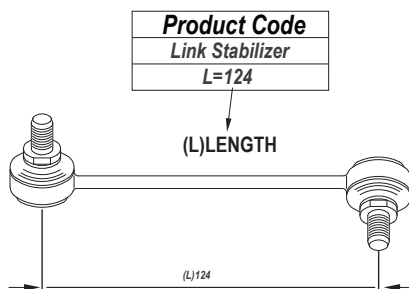
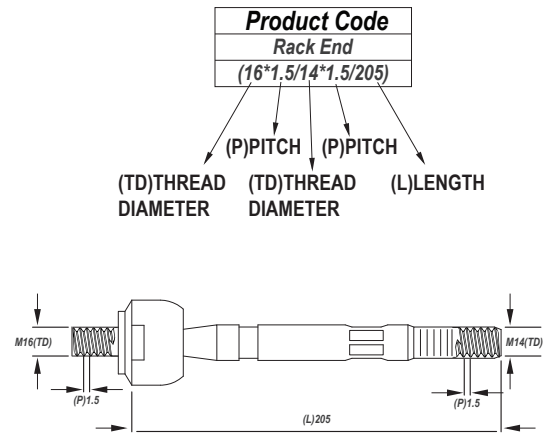
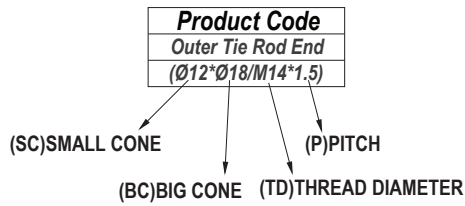

PARALLELOGRAM STEERING

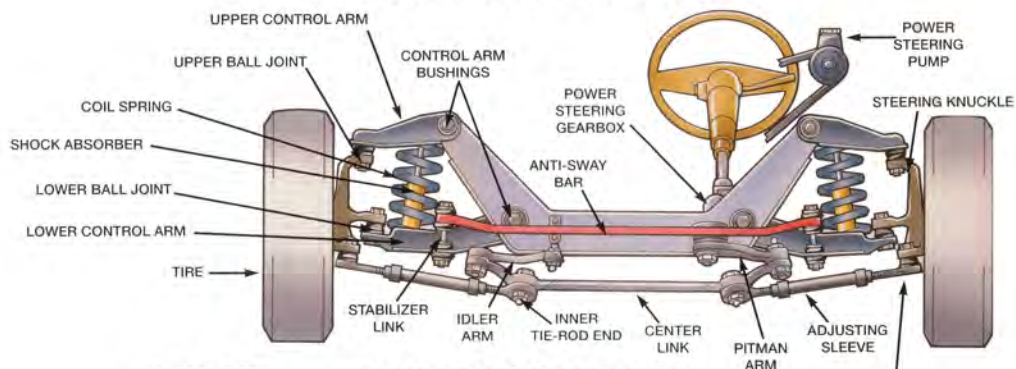

RACK & PINION STEERING

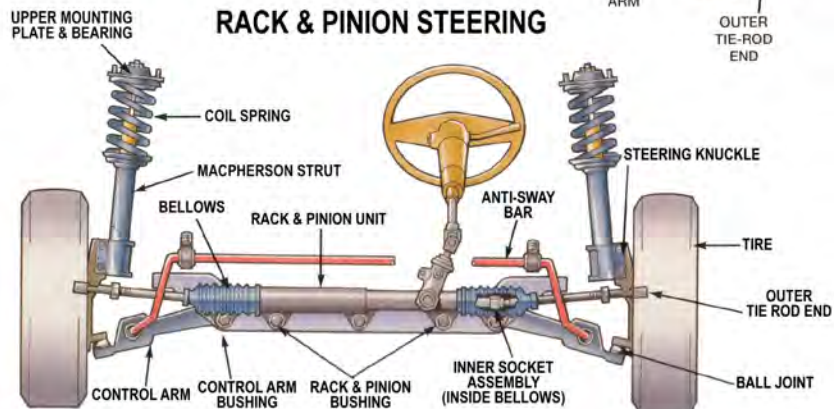

INDEX

ALFA ROMEO	1	-	10
AUDI	11	-	55
BMW	56	-	107
CAM	108	-	109
CHANA	110	-	
CHERY	111	-	112
CHEVROLET	113	-	123
CHRYSLER	124	-	128
CITROEN	129	-	143
CMC	144	-	
DAEWOO	145	-	149
DAIHATSU	150	-	156
DATSUN	157	-	
DODGE	158	-	160
FIAT	161	-	182
FORD	183	-	227
FOTON	228	-	230
GONOW	231	-	
GWM	232	-	
HONDA	233	-	261
HUMMER	262	-	
HYUNDAI	263	-	299
ISUZU	300	-	307
IVECO	308	-	
JAGUAR	309	-	315
JEEP	316	-	325
KIA	326	-	353
LAND ROVER	354	-	372
MAHINDRA	373	-	376
MAZDA	377	-	410
MERCEDES	411	-	469
MINI	470	-	473
MITSUBISHI	474	-	488
NISSAN	489	-	529
OPEL	530	-	552
PEUGEOT	553	-	567
PORSCHE	568	-	573
PROTON	574	-	
RENAULT	575	-	605
ROVER	606	-	
SAAB	607	-	612
SEAT	613	-	618
SMART	619	-	620
SSANGYONG	621	-	623
SUBARU	624	-	629
SUZUKI	630	-	640
TATA	641	-	644
TOYOTA	645	-	670
VOLKSWAGEN	671	-	717
VOLVO	718	-	742

ALFA ROMEO

145-146

FRONT

2.0 QUADROFOGLIO-2.0TI

Year

1996-2001

AF1010
Outer Tie Rod End
(Ø12*Ø13.35/M12*1.5)

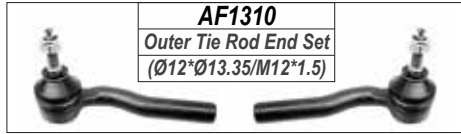

AF1310
Outer Tie Rod End Set
(Ø12*Ø13.35/M12*1.5)

AF1011
Outer Tie Rod End
(Ø12*Ø13.35/M12*1.5)



AF1410
Rack End
(14*1.5 /12*1.5/288)

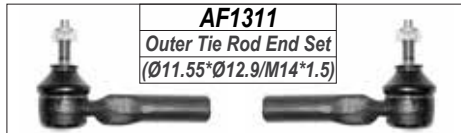

AF1311
Outer Tie Rod End Set
(Ø11.55*Ø12.9/M14*1.5)

AF1012
Outer Tie Rod End
(Ø11.55*Ø12.9/M14*1.5)



AF1411
Rack End
(14*1.5 /12*1.5/270)



AF1012
Outer Tie Rod End
(Ø11.55*Ø12.9/M14*1.5)

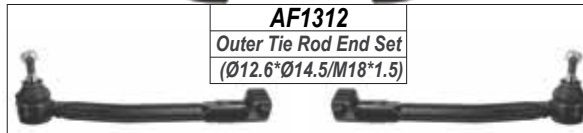

AF1312
Outer Tie Rod End Set
(Ø12.6*Ø14.5/M18*1.5)

AF1013
Outer Tie Rod End
(Ø12.6*Ø14.5/M18*1.5)



AF1412
Rack End
(14*1.5 /14*1.5/293)

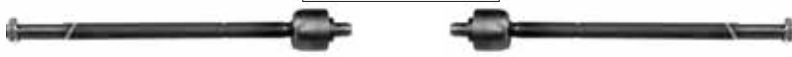

AF1014
Outer Tie Rod End
(Ø12.6*Ø14.5/M18*1.5)



AF1015
Outer Tie Rod End
(Ø12*Ø13.35/M14*1.5)



AF1313
Outer Tie Rod End Set
(Ø12*Ø13.35/M14*1.5)

AF1016
Outer Tie Rod End
(Ø12*Ø13.35/M14*1.5)



AF1510
Link Stabilizer
L=99



AF2113
Stabilizer Bar Bush

AF2112
Lower Control Arm Bush



AF2113
Stabilizer Bar Bush



AF2010
Lower Control Arm

AF2011
Lower Control Arm

AF2810
Shock Mounting



AF2811
Shock Mounting



AF2110 / AF2111
Lower Control Arm Bush

LEFT

RIGHT

ALFA ROMEO

147-156-GT

FRONT

1.6TS.2.0 SELESPEED TS.TS.2.0TS.2.5V6

Year

1997-2010

AF1017
Outer Tie Rod End
(Ø12.57*Ø18.3/M14*1.5)

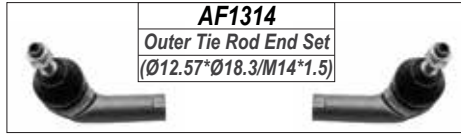

AF1314
Outer Tie Rod End Set
(Ø12.57*Ø18.3/M14*1.5)

AF1413
Rack End
(16*1.5/14*1.5/205)



AF1018
Outer Tie Rod End
(Ø12.57*Ø18.3/M14*1.5)



AF1511
Link Stabilizer
L=124



AF1710
Upper Control Arm



AF1711
Upper Control Arm

AF2114
Lower Control Arm Bush

AF2112
Lower Control Arm Bush

AF2114
Lower Control Arm Bush



AF2012
Lower Control Arm

AF2013
Lower Control Arm

AF2812
Shock Mounting



AF2812
Shock Mounting



AF2115 / AF2116
Lower Control Arm Bush

147-156-GT

REAR

AF1512
Link Stabilizer
L=180



AF1514
Link Stabilizer
L=560



AF1513
Link Stabilizer
L=594



LEFT

RIGHT

ALFA ROMEO

155-GTV SPIDER FRONT

2.0TS.2.5V6

Year

1996-1999

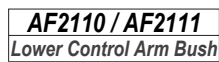
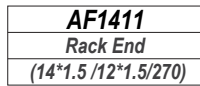
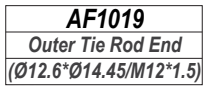
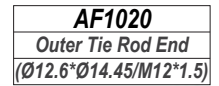
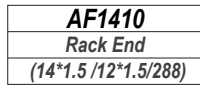
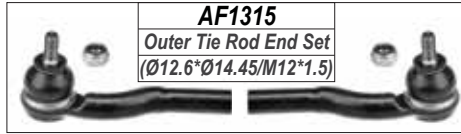

LEFT

RIGHT

ALFA ROMEO

159

FRONT

SALOON.SPORTSWAGON

Year

2005-2011

AF1021
Outer Tie Rod End
(Ø14.6*Ø16.6/M20*1.5)

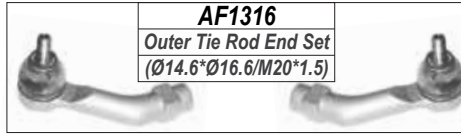

AF1316
Outer Tie Rod End Set
(Ø14.6*Ø16.6/M20*1.5)

AF1414
Rack End
(16*1.5 /20*1.5/213)



AF1022
Outer Tie Rod End
(Ø14.6*Ø16.6/M20*1.5)

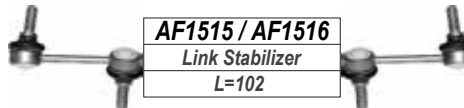

AF1515 / AF1516
Link Stabilizer
L=102



AF1517 / AF1518
Link Stabilizer
L=116



AF1712
Upper Control Arm

AF1713
Upper Control Arm



AF2014
Lower Control Arm

AF2015
Lower Control Arm



AF2117/AF2118
Lower Control Arm Bush

AF2813
Shock Mounting



AF2813
Shock Mounting



159

REAR

AF2814
Shock Mounting



AF2814
Shock Mounting



LEFT

RIGHT

ALFA ROMEO

164

FRONT

3.0 SUPER

Year

1993-1999

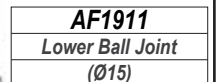
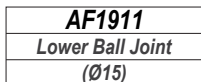
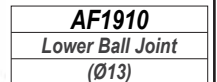
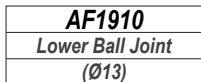
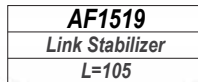
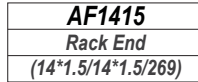
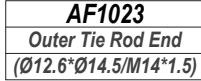
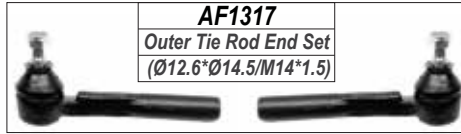

LEFT

RIGHT

ALFA ROMEO

166

FRONT

3.0 SPORTRONIC

Year

1998-2007

AF1017
Outer Tie Rod End
(Ø12.57*Ø14.4/M14*1.5)

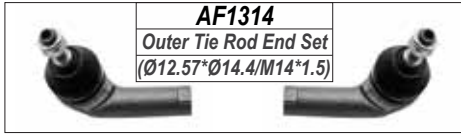

AF1314
Outer Tie Rod End Set
(Ø12.57*Ø14.4/M14*1.5)

AF1416
Rack End
(16*1.5/14*1.5/217)



AF1018
Outer Tie Rod End
(Ø12.57*Ø14.4/M14*1.5)



AF1524
Link Stabilizer
L=145



AF1714
Upper Control Arm

AF1715
Upper Control Arm



AF2020
Lower Control Arm

AF2021
Lower Control Arm

AF2812
Shock Mounting



AF2812
Shock Mounting



166

REAR

AF1526
Link Stabilizer
L=180



AF1522
Link Stabilizer
L=95



AF2022
Lower Control Arm



AF2023
Lower Control Arm



AF1526
Link Stabilizer
L=180



AF1523
Link Stabilizer
L=95



AF1521
Link Stabilizer
L=137



LEFT

RIGHT

ALFA ROMEO

GIULIA

FRONT

(952_) 2.0 Super / 2.9 Quadrifoglio

Year

2016-

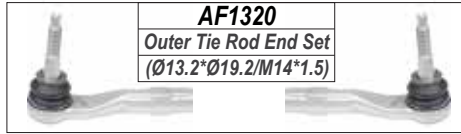

AF1028
Outer Tie Rod End
(Ø13.2*Ø19.2/M14*1.5)

AF1419
Rack End
(16*1.5 /14*1.5/293.5)

AF1028
Outer Tie Rod End
(Ø13.2*Ø19.2/M14*1.5)



AF1531
Link Stabilizer
L=183.5



AF1716
Upper Control Arm



AF1717
Upper Control Arm



AF2028
Lower Control Arm



AF2029
Lower Control Arm



AF2030
Lower Control Arm



AF2031
Lower Control Arm

LEFT

RIGHT

ALFA ROMEO

GIULIETTA

FRONT

940

Year

2010-

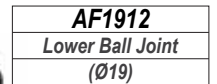
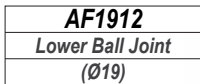
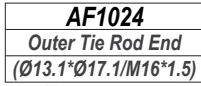
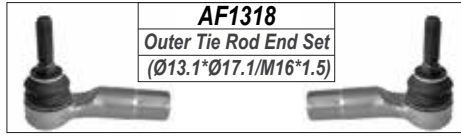

LEFT

RIGHT

ALFA ROMEO

MITO

FRONT

955

Year

2008-

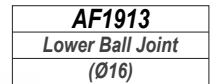
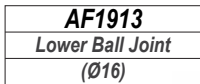
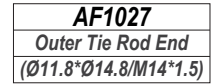
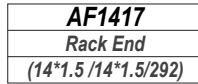
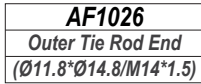
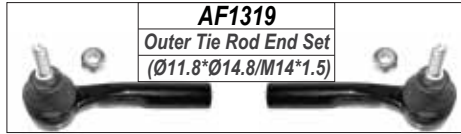

LEFT

RIGHT

ALFA ROMEO

STELVIO

FRONT

Year

(949_) 2.0 Super / 2.9 Quadrifoglio

2016-

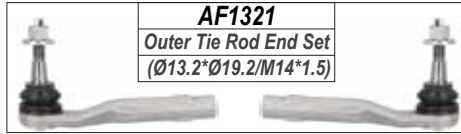

AF1321
Outer Tie Rod End Set
(Ø13.2*Ø19.2/M14*1.5)

AF1029
Outer Tie Rod End
(Ø13.2*Ø19.2/M14*1.5)



AF1419
Rack End
(16*1.5 /14*1.5/293.5)



AF1029
Outer Tie Rod End
(Ø13.2*Ø19.2/M14*1.5)



AF1531
Link Stabilizer
L=183.5



AF1718
Upper Control Arm

AF1719
Upper Control Arm



AF2032
Lower Control Arm



AF2033
Lower Control Arm



AF2034
Lower Control Arm



AF2035
Lower Control Arm

LEFT

RIGHT

AUDI

500

FRONT

2.3E.SE.2.8SEL

Year

1992-1994

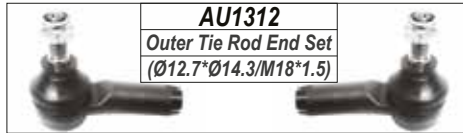
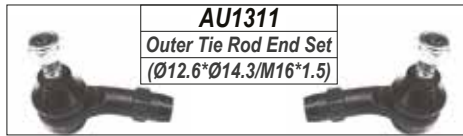

AU1012
<i>Outer Tie Rod End</i>
<i>(Ø12.6*Ø14.3/M16*1.5)</i>



AU1013
<i>Outer Tie Rod End</i>
<i>(Ø12.6*Ø14.3/M16*1.5)</i>



AU1014
<i>Outer Tie Rod End</i>
<i>(Ø12.6*Ø14.3/M16*1.5)</i>



AU1015
<i>Outer Tie Rod End</i>
<i>(Ø12.6*Ø14.3/M16*1.5)</i>



AU1212 / AU1213
<i>Tie Rod Assembly</i>



AU2112
<i>Lower Control Arm Bush</i>



AU2110
<i>Lower Control Arm Bush</i>



AU2014
<i>Lower Control Arm</i>

AU2015
<i>Lower Control Arm</i>

AU2110
<i>Lower Control Arm Bush</i>



500

REAR

AU1510
<i>Link Stabilizer</i>
<i>L=122.50</i>



AU2310 / AU2311
<i>Drag Link</i>



LEFT

RIGHT

AUDI
A1
FRONT
ALL

Year

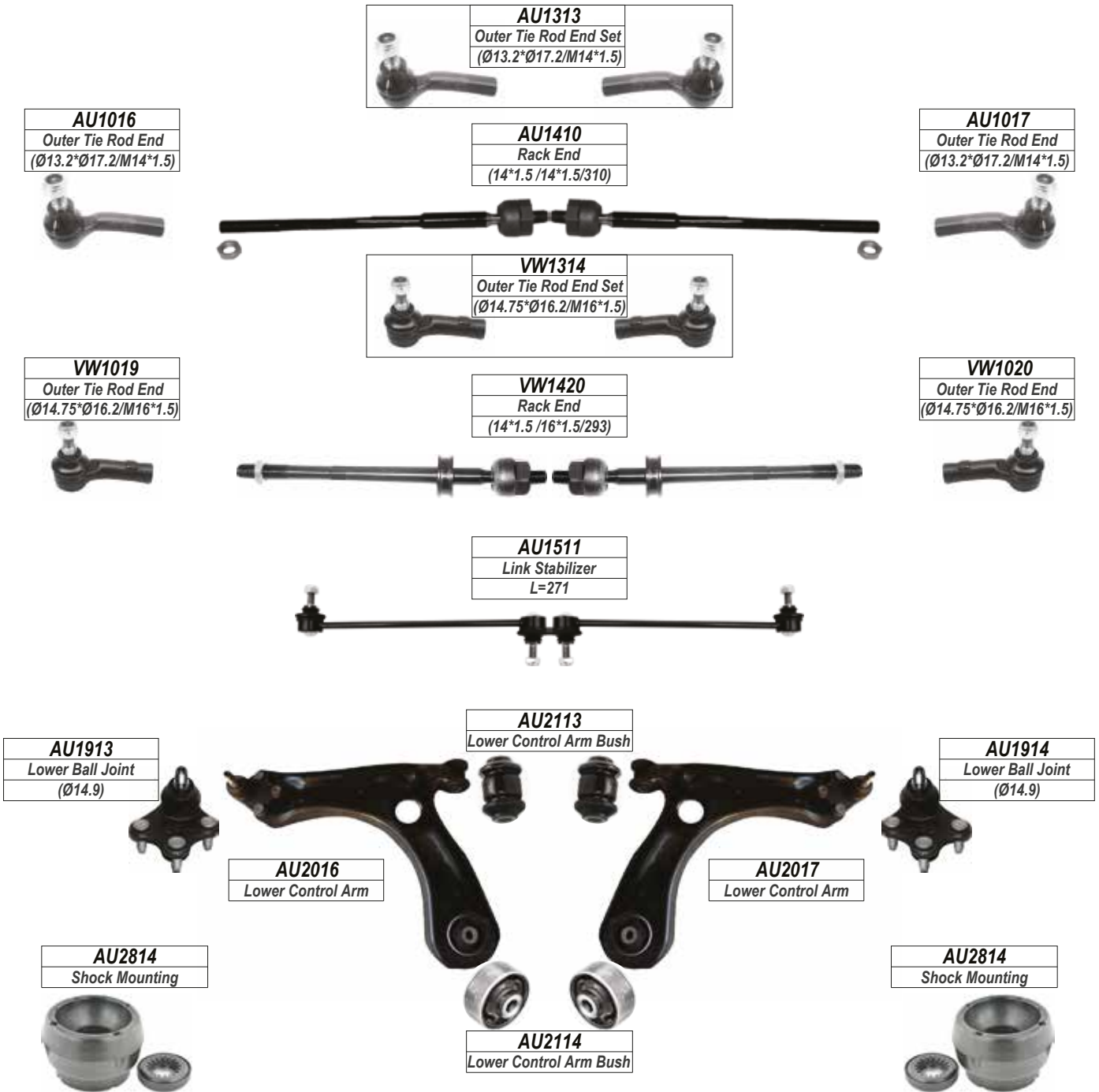
2011-2018

A1
REAR
AU2815
Shock Mounting

AU1512
Link Stabilizer
(M10*1.5/L70.2MM)

AU2815
Shock Mounting

LEFT
RIGHT

AUDI

A1

FRONT

(GBA) 25 TFSi 30 TFSi 35 TFSi 40 TFSi

Year

2018-

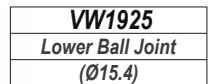
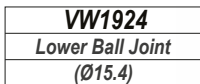
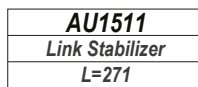
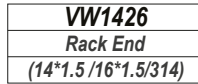
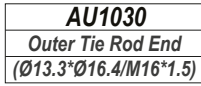
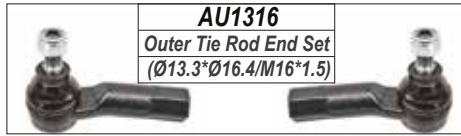

LEFT

RIGHT

AUDI

A3

FRONT

ALL

Year

1998-2002

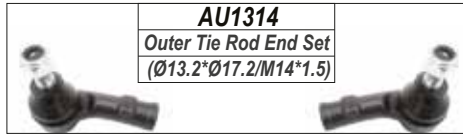

AU1314
Outer Tie Rod End Set
(Ø13.2*Ø17.2/M14*1.5)

AU1018
Outer Tie Rod End
(Ø13.2*Ø17.2/M14*1.5)

AU1412
Rack End
(16*1.5 /14*1.5/341)

AU1019
Outer Tie Rod End
(Ø13.2*Ø17.2/M14*1.5)

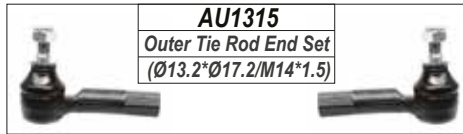

AU1315
Outer Tie Rod End Set
(Ø13.2*Ø17.2/M14*1.5)

AU1020
Outer Tie Rod End
(Ø13.2*Ø17.2/M14*1.5)

AU1411
Rack End
(16*1.5 /14*1.5/320)

AU1021
Outer Tie Rod End
(Ø13.2*Ø17.2/M14*1.5)



AU1915
Lower Ball Joint
(Ø14.9)

AU2113
Lower Control Arm Bush

AU1916
Lower Ball Joint
(Ø14.9)



AU2019
Lower Control Arm

AU2020
Lower Control Arm

AU1513
Link Stabilizer
L=105.5

AU1513
Link Stabilizer
L=105.5



AU1514
Link Stabilizer
L=105.5

AU2114
Lower Control Arm Bush

AU1514
Link Stabilizer
L=105.5



AU1515
Link Stabilizer
L=335

AU2810
Stabilizer Bar Bush

AU1516
Link Stabilizer
L=335



AU2814
Shock Mounting

AU2814
Shock Mounting



LEFT

RIGHT

AUDI

A3

REAR

Year

ALL

1998-2002

AU1517

Link Stabilizer

L=175



AU2913

Bush

(ID: Ø12.2/OD: Ø50)



AU2912

Bush

(ID: Ø12.2/OD: Ø71.5)



AU2815

Shock Mounting



AU2815

Shock Mounting



LEFT

RIGHT

AUDI

A3

FRONT

ALL

Year

2003-2013

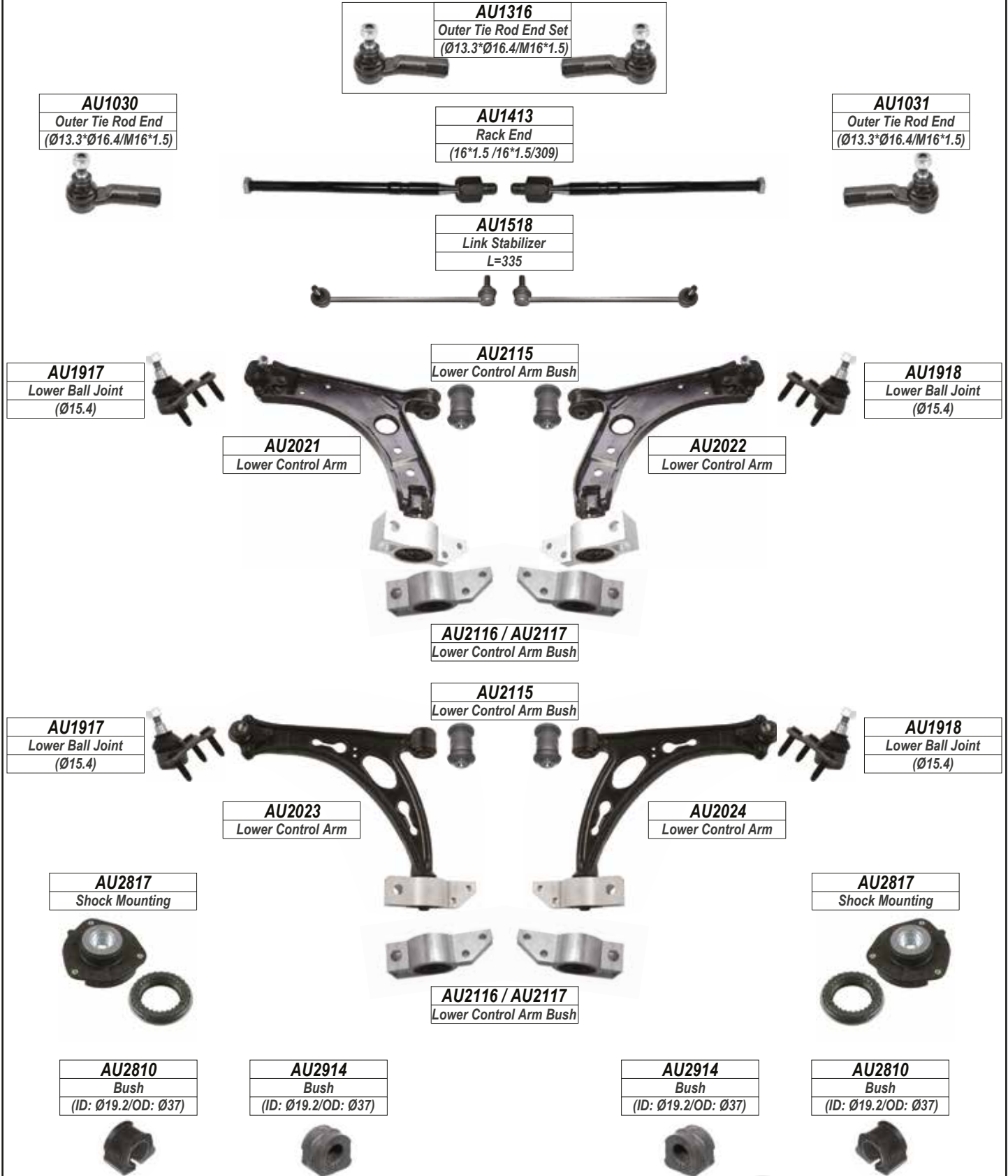

LEFT

RIGHT

AUDI

A3

REAR

ALL

Year

2003-2013

AU1519
Link Stabilizer
L=95.5



AU2915
Bush
(ID: Ø14.3/OD: Ø24.3)



VW2911
Bush

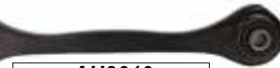

VW2911
Bush

AU2610
Lateral Link

AU2610
Lateral Link

AU1710
Upper Control Arm



AU2080 / AU2081
Lower Control Arm



VW2114
Lower Control Arm Bush



VW2014
Lower Control Arm

VW2014
Lower Control Arm

AU2818
Shock Mounting



AU2818
Shock Mounting



LEFT

RIGHT

AUDI

A3

FRONT

ALL

Year

2012-

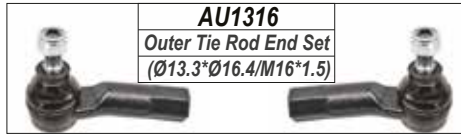

AU1316
Outer Tie Rod End Set
(Ø13.3*Ø16.4/M16*1.5)

AU1030
Outer Tie Rod End
(Ø13.3*Ø16.4/M16*1.5)

AU1413
Rack End
(16*1.5 /16*1.5/309)

AU1031
Outer Tie Rod End
(Ø13.3*Ø16.4/M16*1.5)



AU1520
Link Stabilizer
L=335



AU2115
Lower Control Arm Bush

AU1917
Lower Ball Joint
(Ø15.4)



AU1918
Lower Ball Joint
(Ø15.4)

AU2027
Lower Control Arm

AU2028
Lower Control Arm

AU2826
Shock Mounting

AU2826
Shock Mounting



AU2118
Lower Control Arm Bush



A3

REAR

AU1512
Link Stabilizer
L=70.2



AU2611
Lateral Link



AU2829
Shock Mounting

AU2829
Shock Mounting



AU2082 / AU2083
Lower Control Arm



LEFT

RIGHT

AUDI

A4

FRONT

8D2.8E5.B5.8D5.D2

Year

1994-2001



AU1317
Outer Tie Rod End Set
(Ø13.6*Ø14.8/M14*1.5)

AU1022
Outer Tie Rod End
(Ø13.6*Ø14.8/M14*1.5)



AU1414
Rack End
(16*1.5 /14*1.5/128)

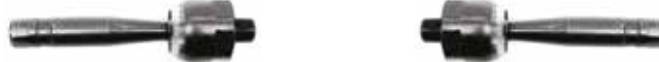

AU1022
Outer Tie Rod End
(Ø13.6*Ø14.8/M14*1.5)



AU1523
Link Stabilizer
L=86



AU1810
Upper Control Arm Bush



AU1523
Link Stabilizer
L=86



AU1711
Upper Control Arm



AU1712
Upper Control Arm

AU1521
Link Stabilizer
L=90



AU1810
Upper Control Arm Bush



AU1522
Link Stabilizer
L=90



AU1713
Upper Control Arm



AU1714
Upper Control Arm



AU2120
Lower Control Arm Bush

AU2121
Lower Control Arm Bush

AU2120
Lower Control Arm Bush

AU2029
Lower Control Arm



AU2029
Lower Control Arm

AU2119
Lower Control Arm Bush



AU2030
Lower Control Arm



AU2031
Lower Control Arm

AU2819
Shock Mounting



AU2819
Shock Mounting



A4

REAR

AU2619 / AU2620
Lateral Link



AU2621
Lateral Link



LEFT

RIGHT

AUDI

A4

FRONT

8E2.B6.8E5

Year

2001-2008



AU1317
Outer Tie Rod End Set
(Ø13.6*Ø14.8/M14*1.5)

AU1022
Outer Tie Rod End
(Ø13.6*Ø14.8/M14*1.5)



AU1414
Rack End
(16*1.5 /14*1.5/128)



AU1022
Outer Tie Rod End
(Ø13.6*Ø14.8/M14*1.5)



AU1523
Link Stabilizer
L=86



AU1524
Link Stabilizer
L=90



AU1525
Link Stabilizer
L=90



AU1523
Link Stabilizer
L=86



AU1810
Upper Control Arm Bush



AU1711
Upper Control Arm

AU1712
Upper Control Arm

AU1810
Upper Control Arm Bush



AU1713
Upper Control Arm

AU1714
Upper Control Arm

AU2121
Lower Control Arm Bush



AU2122
Lower Control Arm Bush
(ID:Ø12.4/OD:40.2/L=37)

AU2032
Lower Control Arm
(Ø16.3)

AU2032
Lower Control Arm
(Ø16.3)

AU2122
Lower Control Arm Bush
(ID:Ø12.4/OD:40.2/L=37)

AU2121
Lower Control Arm Bush



AU2120
Lower Control Arm Bush
(ID:Ø12.2/OD:40.2/L=50)

AU2033
Lower Control Arm
(Ø16.3)

AU2033
Lower Control Arm
(Ø16.3)

AU2120
Lower Control Arm Bush
(ID:Ø12.2/OD:40.2/L=50)

LEFT

RIGHT

AUDI

A4

FRONT

8E2.B6.8E5

Year

2001-2008



AU2820
Shock Mounting



AU2820
Shock Mounting



A4

REAR

AU1526
Link Stabilizer
L=90



AU2622
Lateral Link



AU2821
Shock Mounting



AU2821
Shock Mounting



LEFT

RIGHT

AUDI

A4

FRONT

8K2.B8.8K5

Year

2008-2016

AU1318

Outer Tie Rod End Set
(Ø14.7*Ø19/M16*1.5)



AU1023

Outer Tie Rod End
(Ø14.7*Ø19/M16*1.5)



AU1415

Rack End
(16*1.5 /16*1.5/227)



AU1024

Outer Tie Rod End
(Ø14.7*Ø19/M16*1.5)



AU1527

Link Stabilizer
L=170



AU1528

Link Stabilizer
L=170



AU1810

Upper Control Arm Bush



AU1715

Upper Control Arm

AU1716

Upper Control Arm

AU1811

Upper Control Arm Bush



AU1717

Upper Control Arm

AU1718

Upper Control Arm

AU2124

Lower Control Arm Bush



AU1919

Lower Ball Joint
(Ø13.8)(2008-2011)

AU2125

Lower Control Arm Bush

AU2125

Lower Control Arm Bush

AU1919

Lower Ball Joint
(Ø13.8)(2008-2011)

AU2037

Lower Control Arm
(Ø13.8)(2008-2011)

AU2038

Lower Control Arm
(Ø13.8)(2008-2011)

AU1920

Lower Ball Joint
(Ø17.3)(2011-)

AU2125

Lower Control Arm Bush

AU2126

Lower Control Arm Bush

AU2125

Lower Control Arm Bush

AU1920

Lower Ball Joint
(Ø17.3)(2011-)

AU2039

Lower Control Arm
(Ø17)(2011-)

AU2040

Lower Control Arm
(Ø17)(2011-)

LEFT

RIGHT

AUDI

A4

FRONT

8K2.B8.8K5

Year

2008-2016

AU2127
Lower Control Arm Bush
(OD:Ø65)



AU2041
Lower Control Arm
(Ø15)

AU2127
Lower Control Arm Bush
(OD:Ø65)

AU2042
Lower Control Arm
(Ø15)



AU2043
Lower Control Arm
(Ø17)

AU2128
Lower Control Arm Bush
(OD:Ø75)

AU2044
Lower Control Arm
(Ø17)



AU2045
Lower Control Arm
(Ø17)

AU2046
Lower Control Arm
(Ø17)

AU2822
Shock Mounting



AU2822
Shock Mounting



A4

REAR

AU1529
Link Stabilizer
L=90



AU2623 / AU2624
Lateral Link



AU2047
Lower Control Arm

AU2048
Lower Control Arm

LEFT

RIGHT

AUDI

A4

FRONT

8WH.B9

Year

2016-

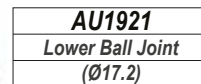
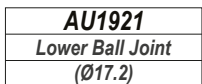
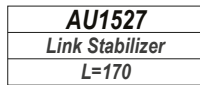
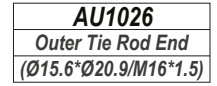
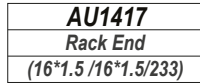
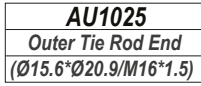
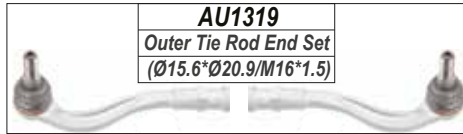

LEFT

RIGHT

AUDI

A5

FRONT

8T3.8F7

Year

2008-2017

AU1318

Outer Tie Rod End Set
(Ø14.7*Ø19/M16*1.5)

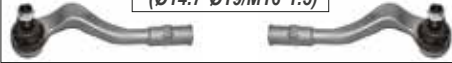

AU1023

Outer Tie Rod End
(Ø14.7*Ø19/M16*1.5)



AU1415

Rack End
(16*1.5 /16*1.5/227)



AU1024

Outer Tie Rod End
(Ø14.7*Ø19/M16*1.5)



AU1416

Rack End
(16*1.5 /16*1.5/235)



AU1530

Link Stabilizer
L=110



AU1528

Link Stabilizer
L=170



AU1530

Link Stabilizer
L=110



AU1527

Link Stabilizer
L=170



AU1527

Link Stabilizer
L=170



AU1810

Upper Control Arm Bush



AU1715

Upper Control Arm



AU1716

Upper Control Arm



AU1811

Upper Control Arm Bush



AU1717

Upper Control Arm



AU1718

Upper Control Arm



AU1919

Lower Ball Joint
(Ø13.8)(2008-2011)



AU2125

Lower Control Arm Bush



AU2124

Lower Control Arm Bush



AU2125

Lower Control Arm Bush



AU1919

Lower Ball Joint
(Ø13.8)(2008-2011)



AU2037

Lower Control Arm
(Ø13.8)(2008-2011)

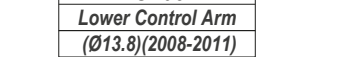

AU2038

Lower Control Arm
(Ø13.8)(2008-2011)

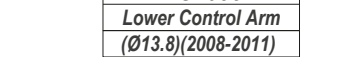

AU1920

Lower Ball Joint
(Ø17.3)(2011-)



AU2125

Lower Control Arm Bush



AU2126

Lower Control Arm Bush



AU2125

Lower Control Arm Bush



AU1920

Lower Ball Joint
(Ø17.3)(2011-)



AU2039

Lower Control Arm
(Ø17)(2011-)

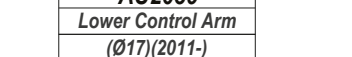

AU2040

Lower Control Arm
(Ø17)(2011-)

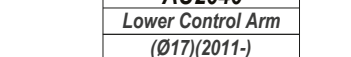

LEFT

RIGHT

AUDI

A5

FRONT

8T3.8F7

Year

2008-2017



A5

REAR

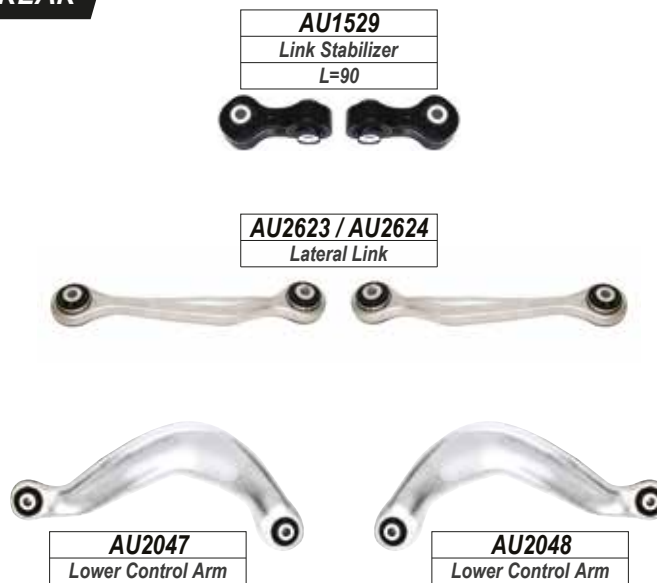

LEFT

RIGHT

AUDI

A5

FRONT

F5A

Year

2017-

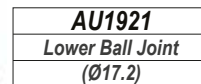
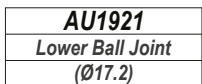
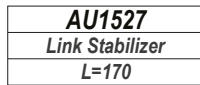
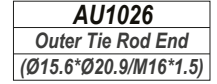
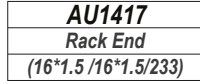
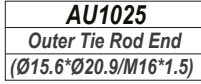
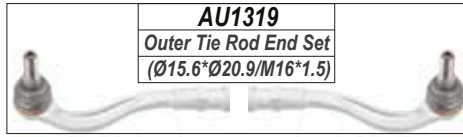

LEFT

RIGHT

AUDI

A6

FRONT

Year

ALL

1994-1997

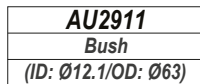
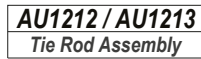
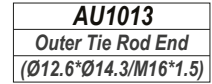
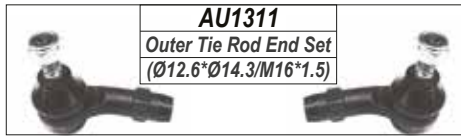

A6

REAR



LEFT

RIGHT

AUDI

A6

FRONT

ALL

Year

1997-2000



AU1022
Outer Tie Rod End
(Ø13.6*Ø14.8/M14*1.5)



AU1414
Rack End
(16*1.5 /14*1.5/128)



AU1022
Outer Tie Rod End
(Ø13.6*Ø14.8/M14*1.5)



AU1523
Link Stabilizer
L=86



AU1810
Upper Control Arm Bush



AU1523
Link Stabilizer
L=86



AU1521
Link Stabilizer
L=90



AU1711
Upper Control Arm



AU1712
Upper Control Arm

AU1522
Link Stabilizer
L=90



AU1810
Upper Control Arm Bush



AU1713
Upper Control Arm



AU2121
Lower Control Arm Bush

AU2120
Lower Control Arm Bush

AU2120
Lower Control Arm Bush

AU2029
Lower Control Arm



AU2119
Lower Control Arm Bush

AU2029
Lower Control Arm

AU2030
Lower Control Arm

AU2031
Lower Control Arm

AU2819
Shock Mounting



AU2819
Shock Mounting



A6

REAR

AU2824
Shock Mounting



AU2824
Shock Mounting



LEFT

RIGHT

AUDI

A6

FRONT

ALL

Year

2001-2005



AU1317
Outer Tie Rod End Set
(Ø13.6*Ø14.8/M14*1.5)

AU1022
Outer Tie Rod End
(Ø13.6*Ø14.8/M14*1.5)



AU1414
Rack End
(16*1.5 /14*1.5/128)



AU1022
Outer Tie Rod End
(Ø13.6*Ø14.8/M14*1.5)



AU1521
Link Stabilizer
L=90



AU1810
Upper Control Arm Bush



AU1522
Link Stabilizer
L=90



AU1711
Upper Control Arm



AU1712
Upper Control Arm

AU1810
Upper Control Arm Bush



AU1713
Upper Control Arm



AU1714
Upper Control Arm

AU2121
Lower Control Arm Bush



AU2120
Lower Control Arm Bush
(ID:Ø12.2/OD:40.2/L=50)



AU2120
Lower Control Arm Bush
(ID:Ø12.2/OD:40.2/L=50)

AU2029
Lower Control Arm
(Ø20.6)



AU2029
Lower Control Arm
(Ø20.6)

AU2122
Lower Control Arm Bush
(ID:Ø12.4/OD:40.2/L=37)



AU2121
Lower Control Arm Bush

AU2122
Lower Control Arm Bush
(ID:Ø12.4/OD:40.2/L=37)

AU2032
Lower Control Arm
(Ø16.3)



AU2032
Lower Control Arm
(Ø16.3)

AU2119
Lower Control Arm Bush



AU2030
Lower Control Arm



AU2031
Lower Control Arm

A6

REAR

AU2824
Shock Mounting



AU1531
Link Stabilizer
L=57.4



AU2824
Shock Mounting



LEFT

RIGHT

AUDI

A6

FRONT

ALL

Year

2005-2011

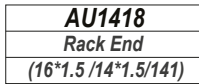
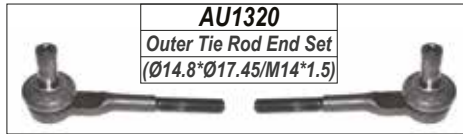

A6

REAR

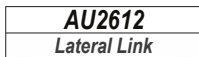
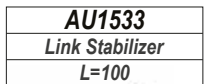
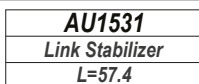

LEFT

RIGHT

AUDI

A6

FRONT

ALL

Year

2011-

AU1318

Outer Tie Rod End Set
(Ø14.7*Ø19/M16*1.5)

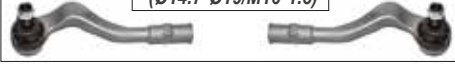

AU1023

Outer Tie Rod End
(Ø14.7*Ø19/M16*1.5)



AU1415

Rack End
(16*1.5 /16*1.5/227)



AU1416

Rack End
(16*1.5 /16*1.5/235)



AU1024

Outer Tie Rod End
(Ø14.7*Ø19/M16*1.5)



AU1530

Link Stabilizer
L=110



AU1527

Link Stabilizer
L=170



AU1528

Link Stabilizer
L=170



AU1530

Link Stabilizer
L=110



AU1527

Link Stabilizer
L=170



AU1810

Upper Control Arm Bush



AU1715

Upper Control Arm



AU1716

Upper Control Arm

AU1811

Upper Control Arm Bush



AU1717

Upper Control Arm



AU1718

Upper Control Arm

AU2124

Lower Control Arm Bush



AU2125

Lower Control Arm Bush



AU2125

Lower Control Arm Bush



AU1919

Lower Ball Joint
(Ø13.8)



AU1919

Lower Ball Joint
(Ø13.8)



AU2037

Lower Control Arm
(Ø13.8)



AU2038

Lower Control Arm
(Ø13.8)



AU1920

Lower Ball Joint
(Ø17.3)



AU2125

Lower Control Arm Bush



AU2126

Lower Control Arm Bush



AU2125

Lower Control Arm Bush



AU1920

Lower Ball Joint
(Ø17.3)



AU2039

Lower Control Arm
(Ø17)



AU2040

Lower Control Arm
(Ø17)



LEFT

RIGHT

AUDI

A6

FRONT

ALL

Year

2011-



AU2820
Shock Mounting



AU2820
Shock Mounting



A6

REAR

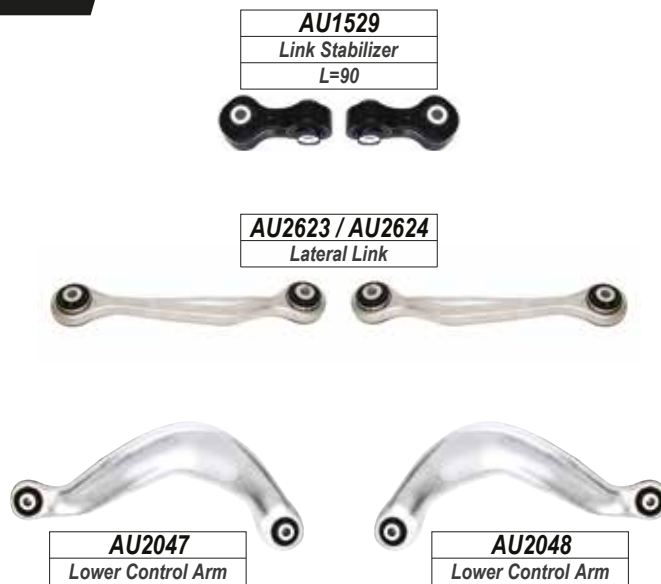

LEFT

RIGHT

AUDI

A7 SPORTBACK FRONT

4GA

Year

2010-

AU1318

Outer Tie Rod End Set
(Ø14.7*Ø19/M16*1.5)

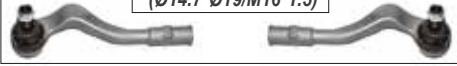

AU1023

Outer Tie Rod End
(Ø14.7*Ø19/M16*1.5)



AU1416

Rack End
(16*1.5 /16*1.5/235)



AU1024

Outer Tie Rod End
(Ø14.7*Ø19/M16*1.5)



AU1528

Link Stabilizer
L=170



AU1810

Upper Control Arm Bush



AU1715

Upper Control Arm



AU1716

Upper Control Arm



AU1811

Upper Control Arm Bush



AU1717

Upper Control Arm



AU1718

Upper Control Arm



AU1919

Lower Ball Joint
(Ø13.8)



AU2125

Lower Control Arm Bush



AU2124

Lower Control Arm Bush



AU2125

Lower Control Arm Bush



AU1919

Lower Ball Joint
(Ø13.8)



AU2037

Lower Control Arm
(Ø13.8)



AU2038

Lower Control Arm
(Ø13.8)



AU1920

Lower Ball Joint
(Ø17.3)



AU2125

Lower Control Arm Bush



AU2126

Lower Control Arm Bush



AU2125

Lower Control Arm Bush



AU1920

Lower Ball Joint
(Ø17.3)



AU2039

Lower Control Arm
(Ø17)



AU2040

Lower Control Arm
(Ø17)



LEFT

RIGHT

AUDI

A7 SPORTBACK FRONT

4GA

Year

2010-

AU2127
Lower Control Arm Bush
(OD:Ø65)



AU2041
Lower Control Arm
(Ø15)

AU2127
Lower Control Arm Bush
(OD:Ø65)

AU2042
Lower Control Arm
(Ø15)



AU2043
Lower Control Arm
(Ø17)

AU2128
Lower Control Arm Bush
(OD:Ø75)

AU2044
Lower Control Arm
(Ø17)



AU2045
Lower Control Arm
(Ø17)

AU2046
Lower Control Arm
(Ø17)

AU2820
Shock Mounting



AU2820
Shock Mounting



A7 SPORTBACK

REAR

AU1534
Lateral Link



AU2058
Lower Control Arm

AU2059
Lower Control Arm

LEFT

RIGHT

AUDI

A8

FRONT

ALL

Year

1994-2001



AU1317
Outer Tie Rod End Set
(Ø13.6*Ø14.8/M14*1.5)

AU1022
Outer Tie Rod End
(Ø13.6*Ø14.8/M14*1.5)



AU1414
Rack End
(16*1.5 /14*1.5/128)



AU1022
Outer Tie Rod End
(Ø13.6*Ø14.8/M14*1.5)



AU1523
Link Stabilizer
L=86



AU1810
Upper Control Arm Bush



AU1523
Link Stabilizer
L=86



AU1711
Upper Control Arm



AU1712
Upper Control Arm

AU1810
Upper Control Arm Bush



AU1532
Link Stabilizer
L=110



AU1713
Upper Control Arm



AU1714
Upper Control Arm

AU1532
Link Stabilizer
L=110



AU2121
Lower Control Arm Bush



AU2120
Lower Control Arm Bush
(ID:Ø12.2/OD:40.2/L=50)

AU2029
Lower Control Arm
(Ø20.6)



AU2029
Lower Control Arm
(Ø20.6)

AU2120
Lower Control Arm Bush
(ID:Ø12.2/OD:40.2/L=50)

AU2121
Lower Control Arm Bush



AU2120
Lower Control Arm Bush
(ID:Ø12.2/OD:40.2/L=50)

AU2033
Lower Control Arm
(Ø16.3)



AU2033
Lower Control Arm
(Ø16.3)

AU2120
Lower Control Arm Bush
(ID:Ø12.2/OD:40.2/L=50)

AU2121
Lower Control Arm Bush



AU2120
Lower Control Arm Bush
(ID:Ø12.2/OD:40.2/L=50)

AU2034
Lower Control Arm
(Ø20.6)(ALLROAD only)



AU2034
Lower Control Arm
(Ø20.6)(ALLROAD only)

AU2120
Lower Control Arm Bush
(ID:Ø12.2/OD:40.2/L=50)

LEFT

RIGHT

AUDI

A8

FRONT

ALL

Year

1994-2001



AU2819
Shock Mounting



AU2819
Shock Mounting



A8

REAR



AU1536 / AU1537
Link Stabilizer
L=62



AU1538
Link Stabilizer
L=95



AU2625
Lateral Link



AU2626
Lateral Link



LEFT

RIGHT

AUDI

A8

FRONT

ALL

Year

2002-2009

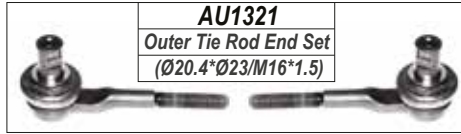

AU1321
Outer Tie Rod End Set
(Ø20.4*Ø23/M16*1.5)

AU1032
Outer Tie Rod End
(Ø20.4*Ø23/M16*1.5)



AU1421
Rack End
(16*1.5 /16*1.5/128)



AU1032
Outer Tie Rod End
(Ø20.4*Ø23/M16*1.5)



AU1811
Lower Control Arm Bush



AU1532
Link Stabilizer
L=110



AU1719
Upper Control Arm



AU1720
Upper Control Arm



AU1532
Link Stabilizer
L=110



AU1810
Lower Control Arm Bush



AU1721
Upper Control Arm



AU1722
Upper Control Arm



AU2125
Lower Control Arm Bush



AU2130
Lower Control Arm Bush



AU2125
Lower Control Arm Bush



AU2060
Lower Control Arm
(Ø20.6)



AU2060
Lower Control Arm
(Ø20.6)



AU2131
Lower Control Arm Bush



AU2061
Lower Control Arm



AU2062
Lower Control Arm



A8

REAR

AU1536 / AU1537
Link Stabilizer
L=62



AU1538
Link Stabilizer
L=95



AU2627
Lateral Link



LEFT

RIGHT

AUDI

A8

FRONT

ALL

Year

2009-

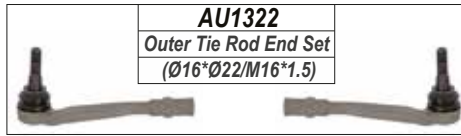

AU1322
Outer Tie Rod End Set
(Ø16*Ø22/M16*1.5)

AU1033
Outer Tie Rod End
(Ø16*Ø22/M16*1.5)



AU1416
Rack End
(16*1.5 /14*1.5/128)



AU1034
Outer Tie Rod End
(Ø16*Ø22/M16*1.5)



AU1539
Link Stabilizer
L=170



AU1812
Upper Control Arm Bush



AU1723
Upper Control Arm



AU1724
Upper Control Arm

AU1812
Upper Control Arm Bush



AU1725
Upper Control Arm



AU1726
Upper Control Arm

AU1922
Lower Ball Joint
(Ø18)



AU2132
Lower Control Arm Bush



AU1922
Lower Ball Joint
(Ø18)



AU2063
Lower Control Arm



AU2064
Lower Control Arm



AU2128
Lower Control Arm Bush



AU2065
Lower Control Arm
(Ø19)



AU2066
Lower Control Arm
(Ø19)



A8

REAR

AU2614 / AU2615
Lateral Link



LEFT

RIGHT

AUDI

COUPE QUATTRO FRONT

Year

CABRIOLET

1982-2000

AU1216 / AU1217
Tie Rod Assembly



AU1924

Lower Ball Joint
(Ø19)



AU2133

Lower Control Arm Bush



AU1925

Lower Ball Joint
(Ø19)



AU2067

Lower Control Arm

AU2068

Lower Control Arm

AU1923

Lower Ball Joint
(Ø19)



AU1923

Lower Ball Joint
(Ø19)



AU2910

Bush

(ID: M8*1.25/OD: Ø30)



LEFT

RIGHT

AUDI

Q2

FRONT

ALL

Year

2016-

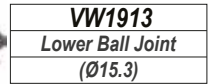
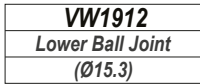
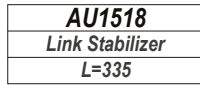
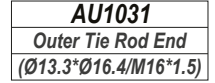
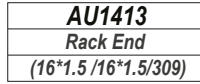
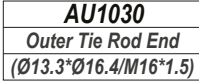
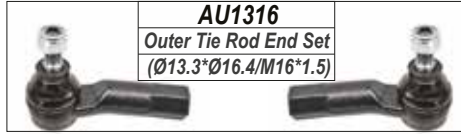

LEFT

RIGHT

AUDI

Q3

FRONT

ALL

Year

2011-

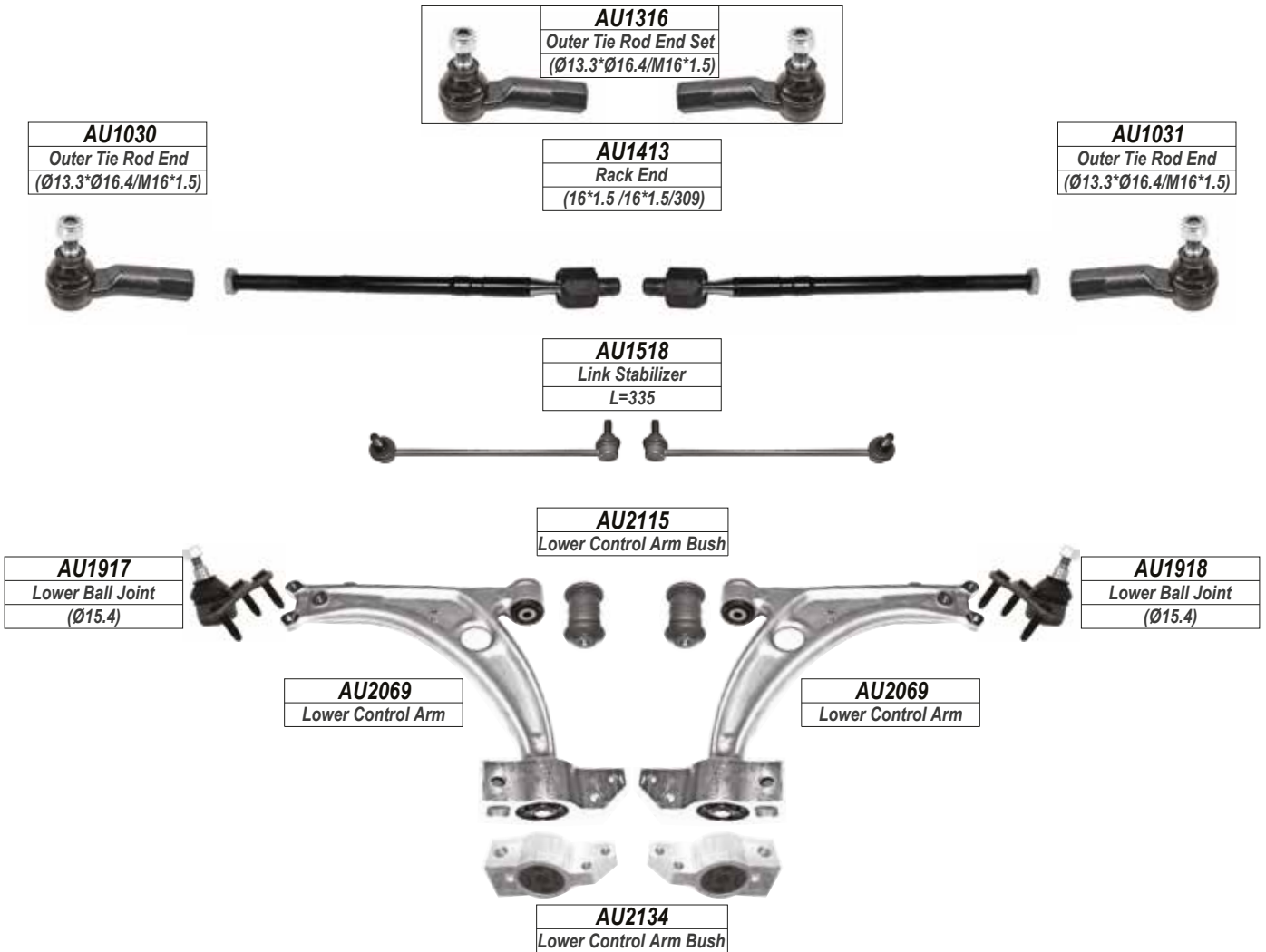

Q3

REAR



LEFT

RIGHT

AUDI

Q3

FRONT

ALL

Year

2019-

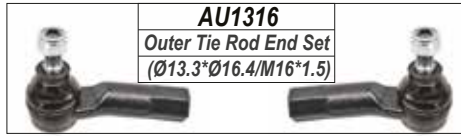

AU1316
Outer Tie Rod End Set
(Ø13.3*Ø16.4/M16*1.5)

AU1030
Outer Tie Rod End
(Ø13.3*Ø16.4/M16*1.5)

AU1413
Rack End
(16*1.5/16*1.5/309)

AU1031
Outer Tie Rod End
(Ø13.3*Ø16.4/M16*1.5)



AU1518
Link Stabilizer
L=335



AU2115
Lower Control Arm Bush

VW1912
Lower Ball Joint
(Ø15.3)



VW1913
Lower Ball Joint
(Ø15.3)



AU2084
Lower Control Arm

AU2085
Lower Control Arm

AU2826
Shock Mounting



AU2118
Lower Control Arm Bush

AU2826
Shock Mounting



Q3

REAR

AU2829
Shock Mounting



VW1712
Upper Control Arm
L=197



VW1712
Upper Control Arm
L=197

AU2829
Shock Mounting



LEFT

RIGHT

AUDI

Q5

FRONT

8RB

Year

2008-2017

AU1318
Outer Tie Rod End Set
(Ø14.7*Ø19/M16*1.5)

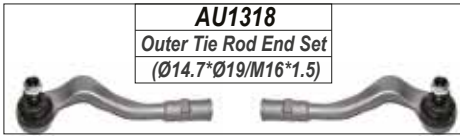

AU1023
Outer Tie Rod End
(Ø14.7*Ø19/M16*1.5)



AU1415
Rack End
(16*1.5/16*1.5/227)



AU1024
Outer Tie Rod End
(Ø14.7*Ø19/M16*1.5)



AU1527
Link Stabilizer
L=170



AU1528
Link Stabilizer
L=170



AU1810
Upper Control Arm Bush



AU1715
Upper Control Arm
Alt:AU1727

AU1716
Upper Control Arm
Alt:AU1728

AU1811
Upper Control Arm Bush



AU1717
Upper Control Arm
Alt:AU1729

AU1718
Upper Control Arm
Alt:AU1730

AU1919
Lower Ball Joint
(Ø13.8)



AU2125
Lower Control Arm Bush

AU2124
Lower Control Arm Bush

AU2125
Lower Control Arm Bush



AU1919
Lower Ball Joint
(Ø13.8)



AU2037
Lower Control Arm
(Ø13.8)

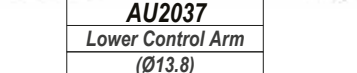

AU2038
Lower Control Arm
(Ø13.8)

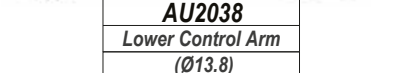

AU1920
Lower Ball Joint
(Ø17.3)



AU2125
Lower Control Arm Bush

AU2126
Lower Control Arm Bush

AU2125
Lower Control Arm Bush



AU1920
Lower Ball Joint
(Ø17.3)



AU2039
Lower Control Arm
(Ø17)

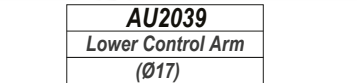

AU2040
Lower Control Arm
(Ø17)

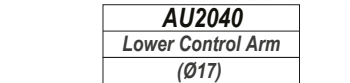

LEFT

RIGHT

AUDI

Q5

FRONT

8RB

Year

2008-2017



Q5

REAR



LEFT

RIGHT

AUDI

Q5

FRONT

FYB FYG

Year

2016-

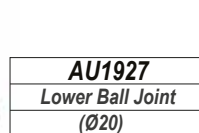
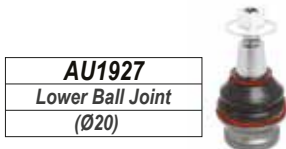
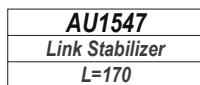
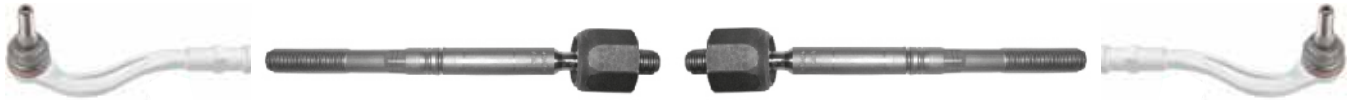
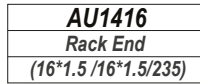
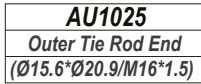
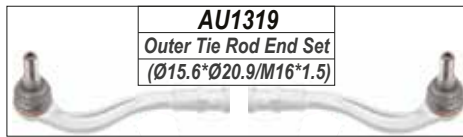

LEFT

RIGHT

AUDI

Q7

FRONT

ALL

Year

2006-2015

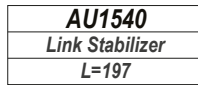
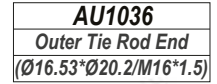
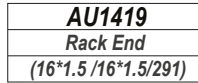
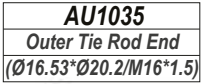
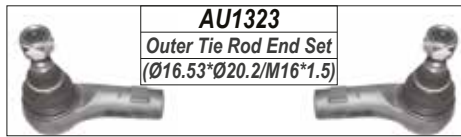

LEFT

RIGHT

AUDI

Q7

REAR

ALL

Year

2006-2015

AU1541 / AU1542
Link Stabilizer
L=201



AU1543 / AU1544
Link Stabilizer
L=200



AU2811
Bush
(ID:12.2/OD:Ø40)

AU2813
Bush
(ID:12.2/OD:Ø40)



AU2813
Bush
(ID:12.2/OD:Ø40)

AU2616
Lateral Link

AU2616
Lateral Link

AU2812
Bush
(ID:16.2/OD:Ø44.3)

AU2813
Bush
(ID:12.2/OD:Ø40)



AU2813
Bush
(ID:12.2/OD:Ø40)

AU2617
Lateral Link

AU2618
Lateral Link

LEFT

RIGHT

AUDI

Q7

FRONT

4MB

Year

2016-

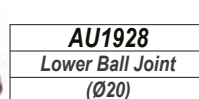
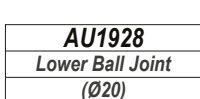
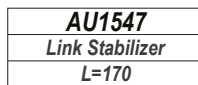
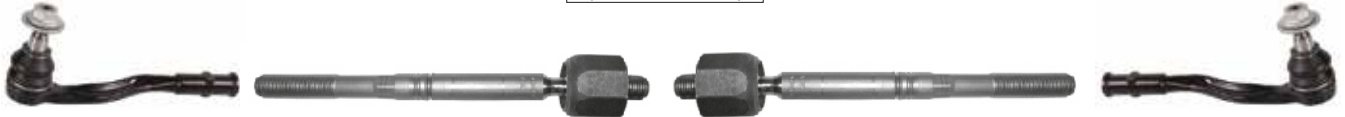
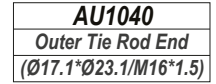
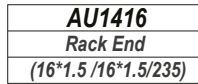
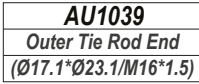
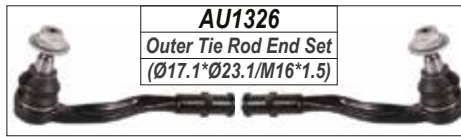

LEFT

RIGHT

AUDI

Q8 Quattro

FRONT

4MN

Year

2018-

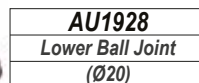
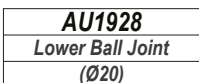
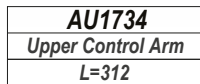
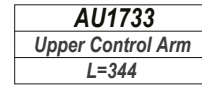
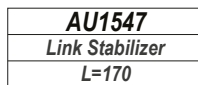
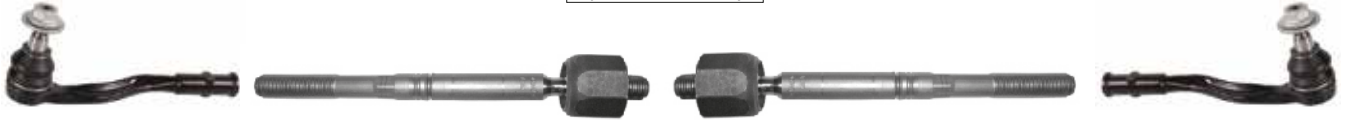
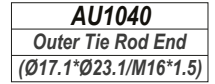
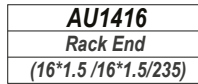
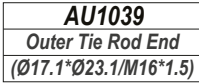
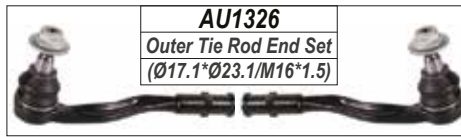

LEFT

RIGHT

AUDI

S3

FRONT

1.8.1.8T

Year

1998-2003

AU1324

Outer Tie Rod End Set
(Ø13.3*Ø15.5/M16*1.5)

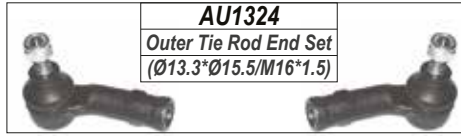

AU1037

Outer Tie Rod End
(Ø13.3*Ø15.5/M16*1.5)



AU1420

Rack End
(16*1.5 /16*1.5/332)



AU1038

Outer Tie Rod End
(Ø13.3*Ø15.5/M16*1.5)



AU1545 / AU1546

Link Stabilizer
L=340

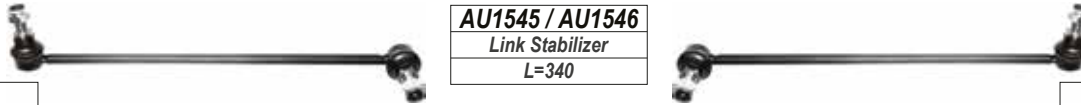

AU1926

Lower Ball Joint
(Ø15.4)



AU2139

Lower Control Arm Bush



AU1926

Lower Ball Joint
(Ø15.4)



AU2076

Lower Control Arm



AU2077

Lower Control Arm

AU2814

Shock Mounting



AU2814

Shock Mounting



AU2114

Lower Control Arm Bush



S3

REAR

AU1517

Link Stabilizer
L=175



VW2910

Bush



VW2910

Bush

VW2610

Lateral Link



VW2610

Lateral Link



VW2611

Lateral Link



VW2611

Lateral Link



AU2913

Bush

(ID: Ø12.2/OD: Ø50)



AU2815

Shock Mounting



AU2815

Shock Mounting



AU2912

Bush

(ID: Ø12.2/OD: Ø71.5)



LEFT

RIGHT

AUDI

S3

FRONT

1.8T QUATTRO

Year

2003-2008

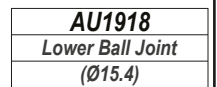
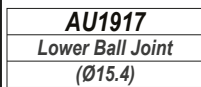
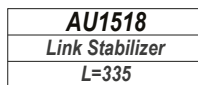
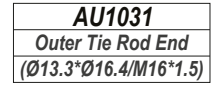
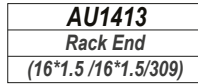
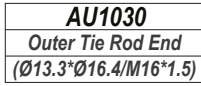
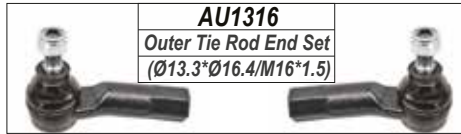

LEFT

RIGHT

AUDI

TT

FRONT

8N3.8N9

Year

2000-2006

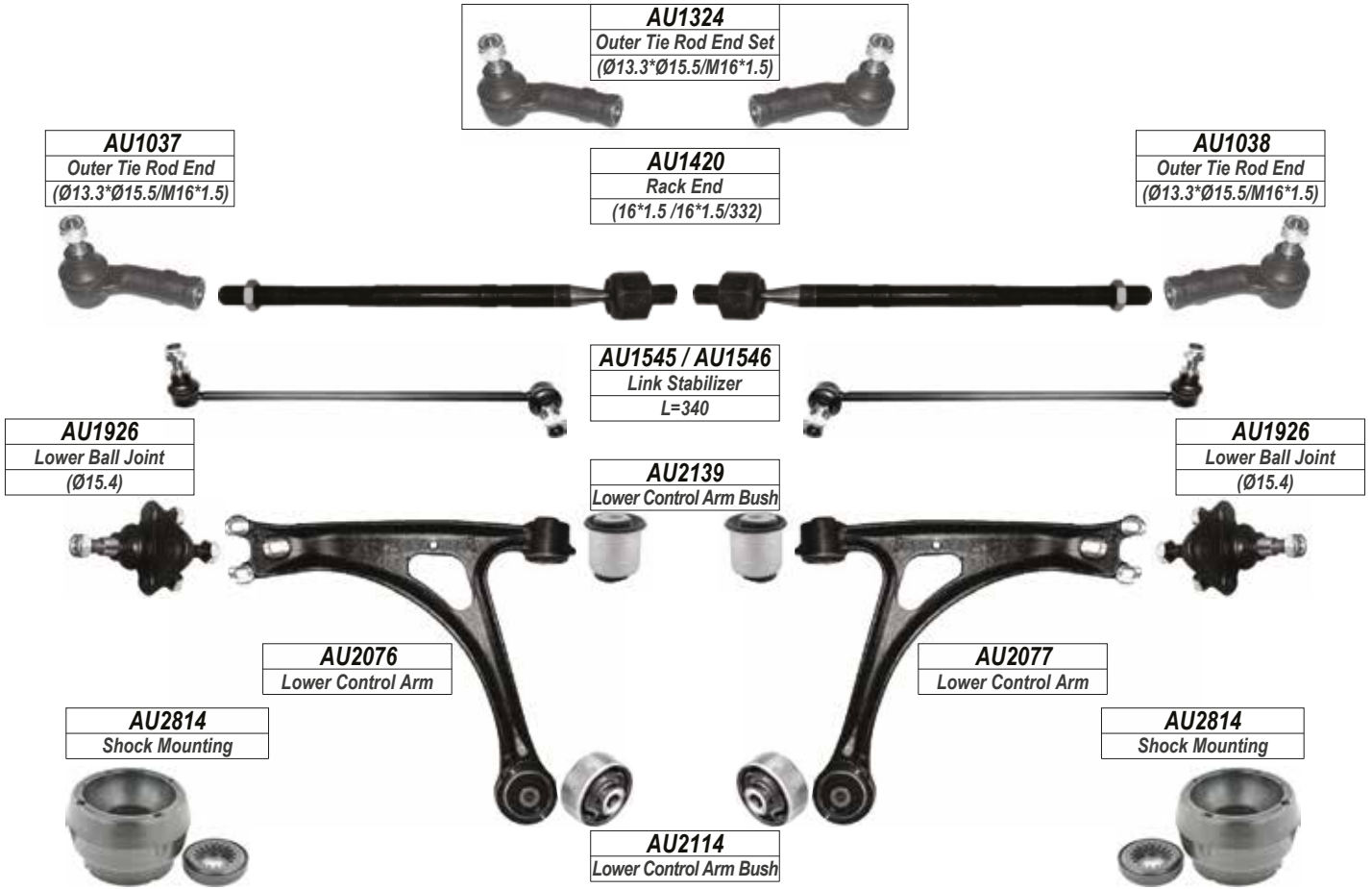

TT

REAR



LEFT

RIGHT

AUDI

TT

FRONT

8J3.8J9 ROADSTER

Year

2006-

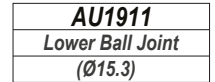
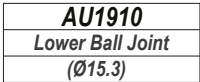
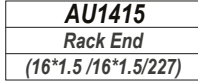
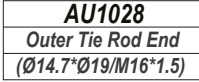
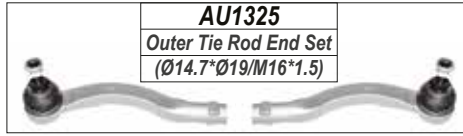

TT

REAR

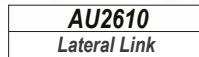
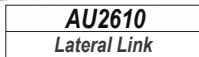
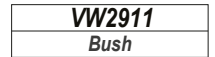
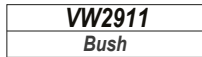
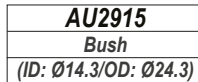

LEFT

RIGHT

AUDI

TT

FRONT

FV3,FV9

Year

2014-

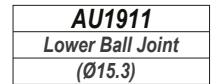
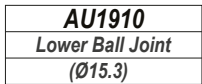
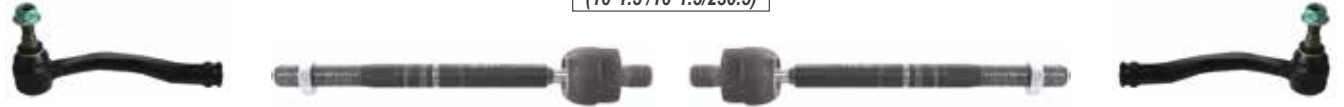
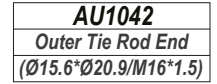
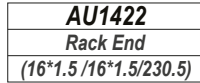
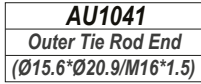
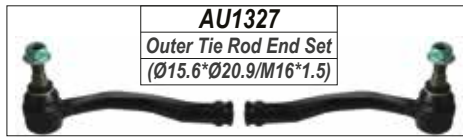

TT

REAR



LEFT

RIGHT

BMW

1 SERIES

FRONT

E81.E87.E87.E88

Year

2004-2010

BM1013
Outer Tie Rod End
(Ø15.7/M14*1.5)

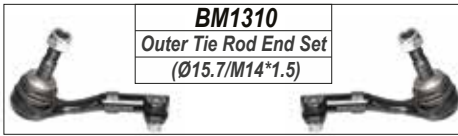

BM1310
Outer Tie Rod End Set
(Ø15.7/M14*1.5)

BM1410
Rack End
(18*1.5 /14*1.5/245)

BM1014
Outer Tie Rod End
(Ø15.7/M14*1.5)



BM1510 / BM1511
Link Stabilizer
L=290

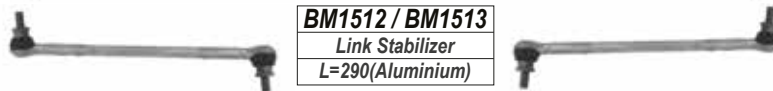

BM1512 / BM1513
Link Stabilizer
L=290(Aluminium)



BM1810
Upper Control Arm Bush

BM1710
Upper Control Arm



BM2110
Lower Control Arm Bush

BM1711
Upper Control Arm



BM2010
Lower Control Arm



BM2011
Lower Control Arm



BM2813
Shock Mounting



BM2813
Shock Mounting



1 SERIES

REAR

BM1514
Link Stabilizer
L=160

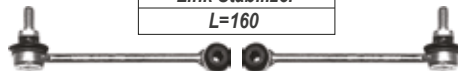

BM2910
Bush

BM2910
Bush



BM2611
Lateral Link

BM2911
Bush



BM2611
Lateral Link

BM2910
Bush



BM2913
Bush



BM2612
Lateral Link
L=273

BM2912
Bush



BM2612
Lateral Link
L=273

BM2913
Bush



BM2913
Bush



BM2613
Lateral Link
L=240



BM2613
Lateral Link
L=240

BM2913
Bush



BMW

1 SERIES

FRONT

F20. F21

Year

2011-

BM1017
Outer Tie Rod End
(Ø16.2/M14*1.5)



BM1312
Outer Tie Rod End Set
(Ø16.2/M14*1.5)

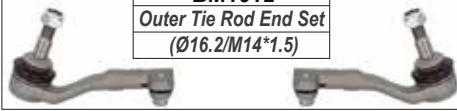

BM1423
Rack End
(16*1.5 / 14*1.5/253)



BM1018
Outer Tie Rod End
(Ø16.2/M14*1.5)



BM1515 / BM1516
Link Stabilizer
L=311



BM1569 / BM1570
Link Stabilizer
L=311



BM1811
Upper Control Arm Bush



BM1712
Upper Control Arm



BM1713
Upper Control Arm



BM2012
Lower Control Arm

BM2111
Lower Control Arm Bush



BM2013
Lower Control Arm

BM2814
Shock Mounting



BM2814
Shock Mounting



1 SERIES

REAR

BM1517 / BM1518
Link Stabilizer
L=135



BM2914
Bush



BM2614
Lateral Link
L=329.4



BM2614
Lateral Link
L=329.4

LEFT

RIGHT

BMW

1 SERIES

FRONT

F40, F52

Year

2017-

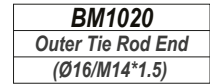
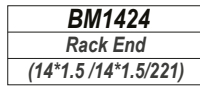
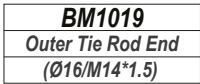
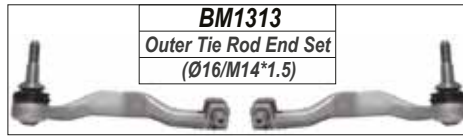

LEFT

RIGHT

BMW

2 SERIES

FRONT

F22

Year

2013-

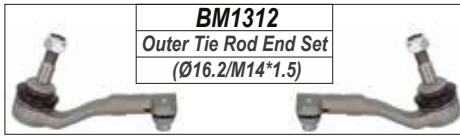

BM1312
Outer Tie Rod End Set
(Ø16.2/M14*1.5)

BM1017
Outer Tie Rod End
(Ø16.2/M14*1.5)



BM1423
Rack End
(16*1.5 / 14*1.5/253)



BM1018
Outer Tie Rod End
(Ø16.2/M14*1.5)



BM1515 / BM1516
Link Stabilizer
L=311



BM1569 / BM1570
Link Stabilizer
L=311



BM1811
Upper Control Arm Bush



BM1712
Upper Control Arm



BM1713
Upper Control Arm



BM2012
Lower Control Arm

BM2111
Lower Control Arm Bush



BM2013
Lower Control Arm

BM2814
Shock Mounting



BM2814
Shock Mounting



2 SERIES

REAR

BM1517 / BM1518
Link Stabilizer
L=135



BM2914
Bush



BM2614
Lateral Link
L=329.4



BM2614
Lateral Link
L=329.4

LEFT

RIGHT

BMW

2 SERIES

FRONT

F44,F45

Year

2015-

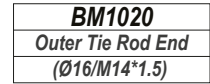
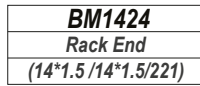
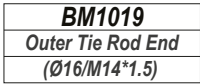
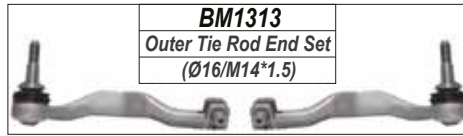

LEFT

RIGHT

BMW

3 SERIES

FRONT

E30

Year

1982-1993

BM1314
Outer Tie Rod End Set
(Ø12.6*Ø14.2/M14*1.5)

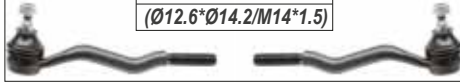

BM1021
Outer Tie Rod End
(Ø12.6*Ø14.2/M14*1.5)



BM1425
Rack End
(18*1.5/14*1.5/232)



BM1021
Outer Tie Rod End
(Ø12.6*Ø14.2/M14*1.5)



BM1411
Rack End
(18*1.5/14*1.5/232)



BM1520
Link Stabilizer
L=66.5

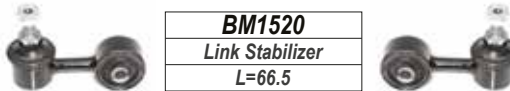

BM1521
Link Stabilizer
L=239



BM1911
Lower Ball Joint
(Ø14.9)

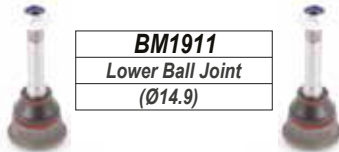

BM1910
Lower Ball Joint
(Ø14.5)



BM1910
Lower Ball Joint
(Ø14.5)



BM2016
Lower Control Arm



BM2017
Lower Control Arm



BM2815
Shock Mounting



BM2815
Shock Mounting



BM2115
Lower Control Arm Bush



BM2114
Lower Control Arm Bush



BM2116
Lower Control Arm Bush



2 SERIES

REAR

BM2915
Bush
(ID: Ø12 OD:Ø35 L:70)

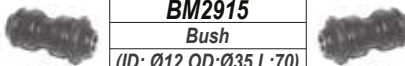

BM1522
Link Stabilizer
L=100

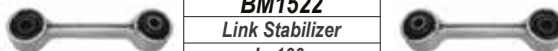

BM2816
Shock Mounting



BM2816
Shock Mounting



BM2916
Bush
(ID: Ø17 OD:Ø85 L:30)



LEFT

RIGHT

BMW

3 SERIES

FRONT

E36.Z3

Year

1992-2000

BM1022
Outer Tie Rod End
(Ø12.6*Ø14.2/M14*1.5)



BM1315
Outer Tie Rod End Set
(Ø12.6*Ø14.2/M14*1.5)

BM1412
Rack End
(18*1.5 /14*1.5/205)



BM1023
Outer Tie Rod End
(Ø12.6*Ø14.2/M14*1.5)

BM1413
Rack End
(18*1.5 /14*1.5/206)



BM1520
Link Stabilizer
L=66.5

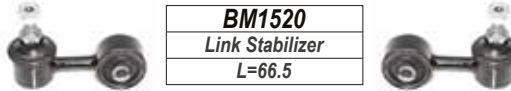

BM1523
Link Stabilizer
L=239

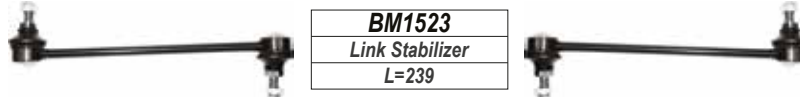

BM1912
Lower Ball Joint
(Ø14.4/L=17)



BM1911
Lower Ball Joint
(Ø14.9)



BM2018
Lower Control Arm

BM2019
Lower Control Arm

BM1912
Lower Ball Joint
(Ø14.4/L=17)



BM1913
Lower Ball Joint
(Ø14.4/L=20.6)



BM1913
Lower Ball Joint
(Ø14.4/L=20.6)



BM2115
Lower Control Arm Bush



BM2116
Lower Control Arm Bush



BM2810
Stabilizer Bar Bush



BM2117
Lower Control Arm Bush



BM2810
Stabilizer Bar Bush

BM2817
Shock Mounting



BM2817
Shock Mounting



LEFT

RIGHT

BMW
3 SERIES
REAR
E36.Z3

Year

1992-2000

BM2610
Lateral Link
L=557



BM2610
Lateral Link
L=557



BM1522
Link Stabilizer
L=100



BM2119
Lower Control Arm Bush
(ID: Ø22.5 OD:Ø45.2)



BM2118
Lower Control Arm Bush
(ID: Ø23.8 OD:Ø35.5)



BM2120
Lower Control Arm Bush
(ID: Ø12.2 OD:Ø45.4)



BM2917
Bush
(ID: Ø12.5 OD:Ø46)



BM2918
Bush
(ID: Ø12.2 OD:Ø60.5)



BM2919
Bush
(ID: Ø24 OD:Ø43)



BM2920
Bush
(ID: Ø20.3 OD:Ø40.5)



BM2921
Bush
(ID: Ø23 OD:Ø46.4)



BM2922
Bush
(ID: Ø15.6 OD:Ø67.9)



BM2816
Shock Mounting



BM2816
Shock Mounting

LEFT
RIGHT

BMW

3 SERIES

FRONT

E46.Z4

Year

1998-2005

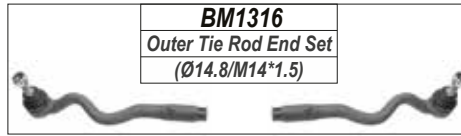

BM1316
Outer Tie Rod End Set
(Ø14.8/M14*1.5)

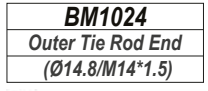

BM1024
Outer Tie Rod End
(Ø14.8/M14*1.5)

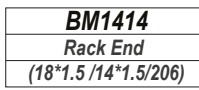

BM1414
Rack End
(18*1.5 /14*1.5/206)

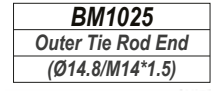

BM1025
Outer Tie Rod End
(Ø14.8/M14*1.5)

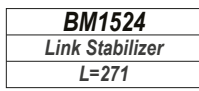
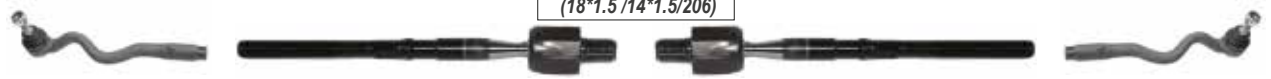

BM1524
Link Stabilizer
L=271

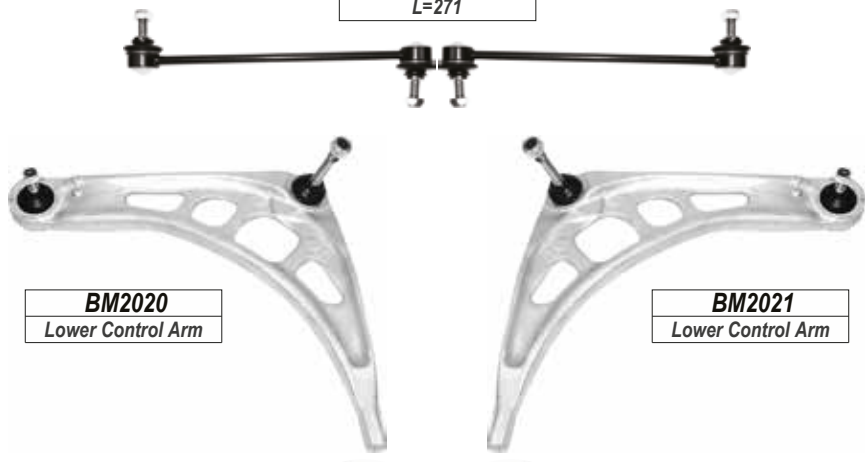

BM2020
Lower Control Arm

BM2021
Lower Control Arm



BM2121
Lower Control Arm Bush



BM2122
Lower Control Arm Bush



BM2123
Lower Control Arm Bush



BM2713
Complete



BM2714
Complete



BM2813
Shock Mounting



BM2813
Shock Mounting

LEFT

RIGHT

BMW

3 SERIES

REAR

E46.Z4

Year

1998-2005



BM1525
Link Stabilizer
L=95



BM2119
Lower Control Arm Bush
(ID: Ø22.5 OD:Ø45.2)



BM2118
Lower Control Arm Bush
(ID: Ø23.8 OD:Ø35.5)



BM2120
Lower Control Arm Bush
(ID: Ø12.2 OD:Ø45.4)



BM2923
Bush
(ID: Ø16.5 OD:Ø40)



BM2919
Bush
(ID: Ø24 OD:Ø43)



BM2918
Bush
(ID: Ø12.2 OD:Ø60.5)



BM2938
(Rear Diff. Bush)
(ID: Ø12.2 OD:Ø60.5)



BM2816
Shock Mounting



BM2816
Shock Mounting



LEFT

RIGHT

BMW

3 SERIES

FRONT

E90.E91.E92.E93

Year

2005-2011

BM1013
Outer Tie Rod End
(Ø15.7/M14*1.5)

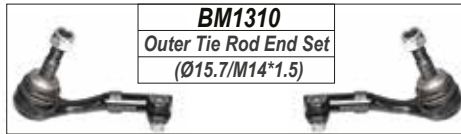

BM1310
Outer Tie Rod End Set
(Ø15.7/M14*1.5)

BM1410
Rack End
(18*1.5 /14*1.5/245)

BM1014
Outer Tie Rod End
(Ø15.7/M14*1.5)

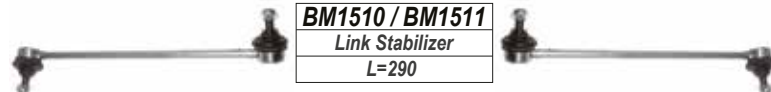

BM1510 / BM1511
Link Stabilizer
L=290

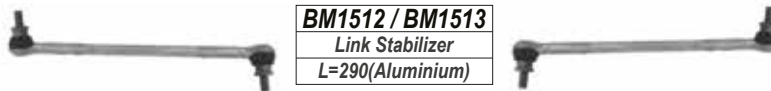

BM1512 / BM1513
Link Stabilizer
L=290(Aluminium)

BM1810
Upper Control Arm Bush



BM1710
Upper Control Arm



BM1711
Upper Control Arm



BM1762
Upper Control Arm
M3 Only

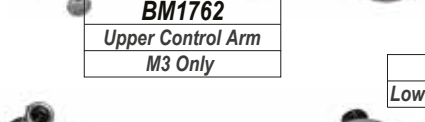

BM1763
Upper Control Arm
M3 Only

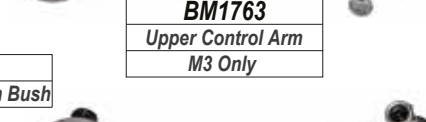

BM2110
Lower Control Arm Bush



BM2010
Lower Control Arm



BM2011
Lower Control Arm



BM2124
Lower Control Arm Bush



BM2022
Lower Control Arm
3.35i Only

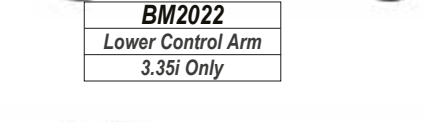

BM2022
Lower Control Arm
3.35i Only

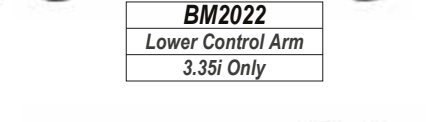

BM2023
Lower Control Arm
M3 Only



BM2024
Lower Control Arm
M3 Only



BM2813
Shock Mounting



BM2813
Shock Mounting



LEFT

RIGHT

BMW

3 SERIES

REAR

E90.E91.E92.E93

Year

2005-2011

BM1514

Link Stabilizer

L=160

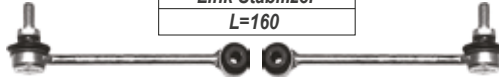

BM2910

Bush

BM2910

Bush

BM2910

Bush



BM2611

Lateral Link

L=413.5

BM2611

Lateral Link

L=413.5

BM2913

Bush

BM2911

Bush

BM2913

Bush



BM2612

Lateral Link

L=273

BM2612

Lateral Link

L=273

BM2912

Bush

BM2913

Bush

BM2913

Bush



BM2613

Lateral Link

L=240

BM2613

Lateral Link

L=240

BM2125

Bush

(ID: Ø14.1 OD:Ø47.3)



LEFT

RIGHT

BMW

3 SERIES

FRONT

F30.F31.F34.F35.F80

Year

2011-

BM1017
Outer Tie Rod End
(Ø16.2/M14*1.5)

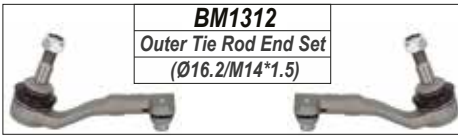

BM1312
Outer Tie Rod End Set
(Ø16.2/M14*1.5)

BM1423
Rack End
(16*1.5 /14*1.5/253)

BM1018
Outer Tie Rod End
(Ø16.2/M14*1.5)



BM1515 / BM1516
Link Stabilizer
L=311

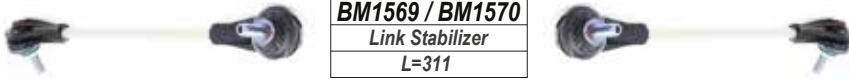

BM1569 / BM1570
Link Stabilizer
L=311



BM1712
Upper Control Arm

BM1713
Upper Control Arm

BM1811
Upper Control Arm Bush



BM2012
Lower Control Arm

BM2013
Lower Control Arm

BM2111
Lower Control Arm Bush

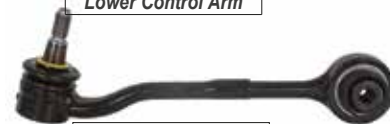

BM2025
Lower Control Arm
M3 Only



BM2026
Lower Control Arm
M3 Only

BM2814
Shock Mounting



BM2814
Shock Mounting



3 SERIES

REAR



BM1517 / BM1518
Link Stabilizer
L=135

BM2914
Bush

BM2614
Lateral Link
L=329.4

BM2614
Lateral Link
L=329.4

LEFT

RIGHT

BMW			Year
3 SERIES	FRONT	G20, G21	2019-

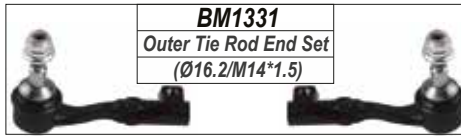

BM1042
Outer Tie Rod End
(Ø16.2/M14*1.5)



BM1429
Rack End
(16*1.5 / 14*1.5/268)



BM1043
Outer Tie Rod End
(Ø16.2/M14*1.5)



BM1571 / BM1572
Link Stabilizer
L=361



BM2073
Lower Control Arm
L=370 (RWD)

BM2143
Lower Control Arm Bush

BM2074
Lower Control Arm
L=370 (RWD)



BM2075
Lower Control Arm
L=310 (340i X-Drive)

BM2076
Lower Control Arm
L=310 (340i X-Drive)



BM2077
Lower Control Arm



BM2078
Lower Control Arm

LEFT

RIGHT

BMW

4 SERIES

FRONT

F32.F82.F83

Year

2013-

BM1017
Outer Tie Rod End
(Ø16.2/M14*1.5)

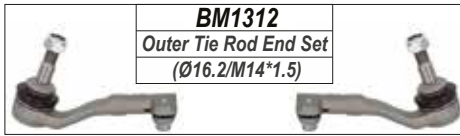

BM1312
Outer Tie Rod End Set
(Ø16.2/M14*1.5)

BM1423
Rack End
(16*1.5 /14*1.5/253)

BM1018
Outer Tie Rod End
(Ø16.2/M14*1.5)



BM1515 / BM1516
Link Stabilizer
L=311



BM1569 / BM1570
Link Stabilizer
L=311



BM1811
Upper Control Arm Bush



BM1712
Upper Control Arm



BM1713
Upper Control Arm



BM2111
Lower Control Arm Bush



BM2012
Lower Control Arm



BM2013
Lower Control Arm



BM2025
Lower Control Arm
M4 Only

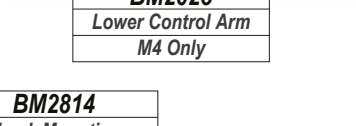

BM2026
Lower Control Arm
M4 Only

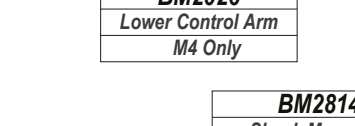

BM2814
Shock Mounting



BM2814
Shock Mounting



5 SERIES

REAR



BM1517 / BM1518
Link Stabilizer
L=135



BM2914
Bush



BM2614
Lateral Link
L=329.4



BM2614
Lateral Link
L=329.4

LEFT

RIGHT

BMW

5 SERIES

FRONT

E28

Year

1985-1989

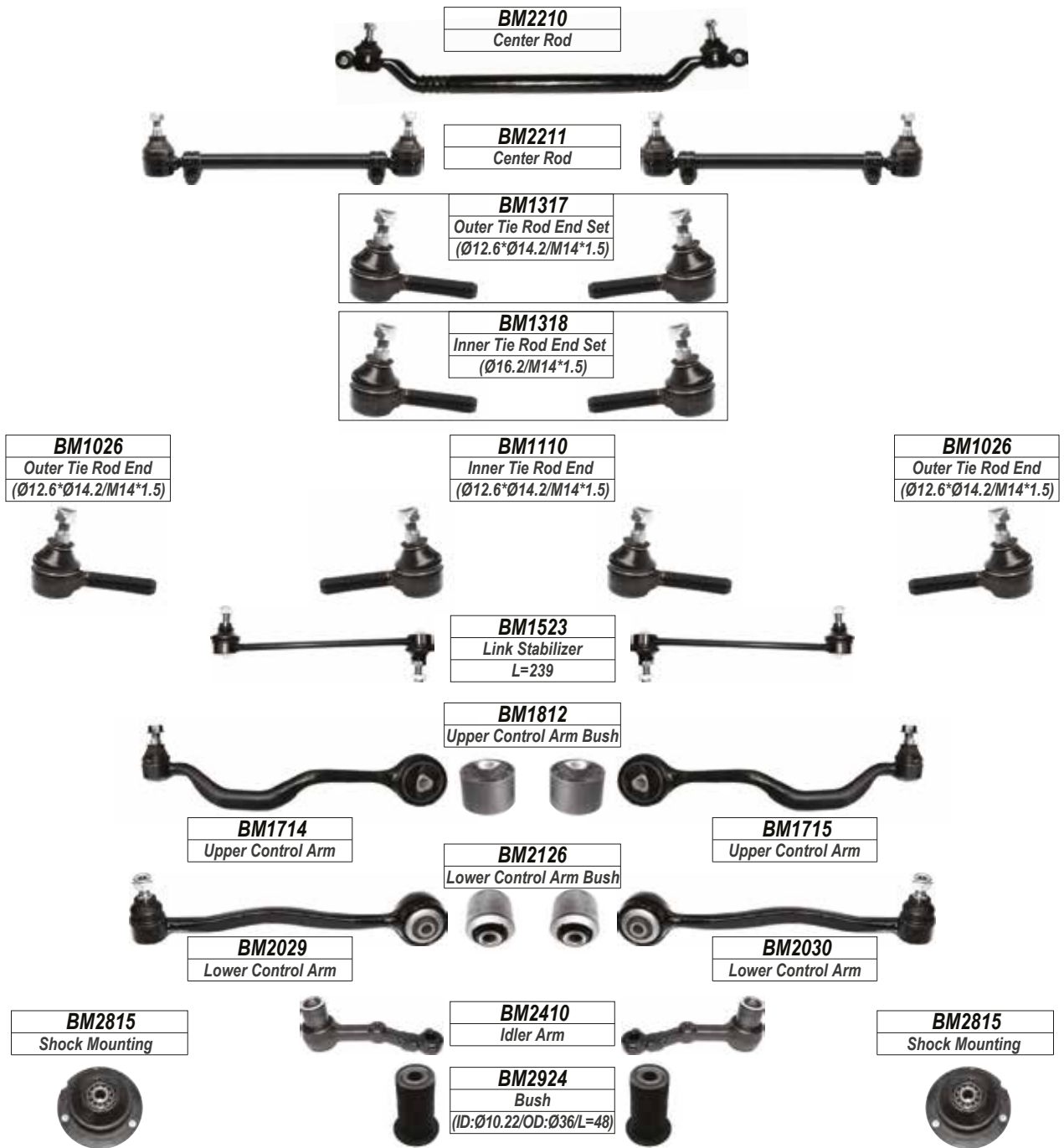

5 SERIES

REAR

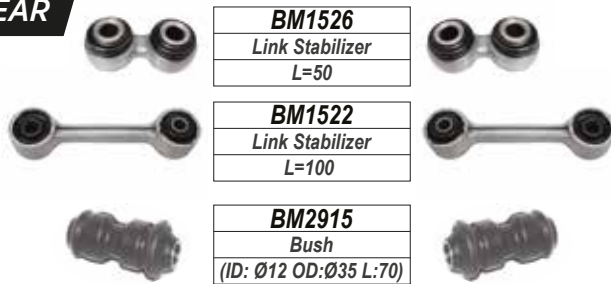

LEFT

RIGHT

BMW

5 SERIES

FRONT

E34

Year

1989-1997



BM2212
Center Rod



BM2213
Center Rod

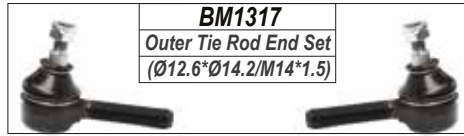

BM1317
Outer Tie Rod End Set
(Ø12.6*Ø14.2/M14*1.5)

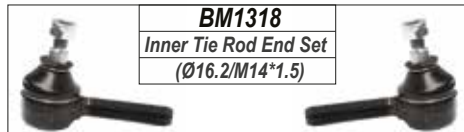

BM1318
Inner Tie Rod End Set
(Ø16.2/M14*1.5)

BM1026
Outer Tie Rod End
(Ø12.6*Ø14.2/M14*1.5)



BM1110
Inner Tie Rod End
(Ø12.6*Ø14.2/M14*1.5)



BM1110
Inner Tie Rod End
(Ø12.6*Ø14.2/M14*1.5)



BM1026
Outer Tie Rod End
(Ø12.6*Ø14.2/M14*1.5)

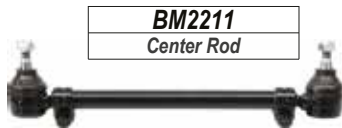

BM2211
Center Rod

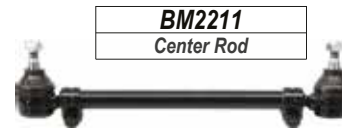

BM2211
Center Rod



BM1523
Link Stabilizer
L=239



BM1813
Upper Control Arm Bush

BM1716
Upper Control Arm



BM2126
Lower Control Arm Bush

BM1717
Upper Control Arm

BM2820
Shock Mounting



BM2029
Lower Control Arm



BM2410
Idler Arm



BM2030
Lower Control Arm



BM2820
Shock Mounting



BM2818
Shock Mounting(2.5)



BM2924
Bush
(ID:Ø10.22/OD:Ø36/L=48)



BM2818
Shock Mounting(2.5)



BM2815
Shock Mounting(2.0)



BM2810
Stabilizer Bar Bush



BM2815
Shock Mounting(2.0)



LEFT

RIGHT

BMW

5 SERIES

REAR

E34

Year

1989-1997



BM1526
Link Stabilizer
L=50



BM2915
Bush
(ID: Ø12 OD:Ø35 L:70)



BM2920
Bush
(ID: Ø20.3 OD:Ø40.5)



BM2926
Bush
(ID:Ø15.8/OD:Ø51)



LEFT

RIGHT

BMW

5 SERIES

FRONT

E39(523.525.528.530.530D)

Year

1996-2004

BM2214

Center Rod



BM1319

Outer Tie Rod End Set
(Ø12.75*Ø16.4/M16*1.0)



BM1027

Outer Tie Rod End
(Ø12.75*Ø16.4/M16*1.0)



BM1415

Rack End
(18*1.5 /16*1.0/175)



BM1028

Outer Tie Rod End
(Ø12.75*Ø16.4/M16*1.0)



BM1527 / BM1528

Link Stabilizer
L=240



BM1814

Upper Control Arm Bush



BM1718

Upper Control Arm

BM1719

Upper Control Arm

BM2127

Lower Control Arm Bush



BM2031

Lower Control Arm

BM2032

Lower Control Arm

BM2924

Bush

(ID:Ø10.22/OD:Ø36/L=48)

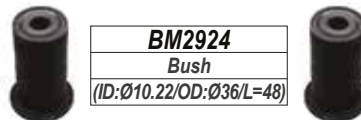

BM2813

Shock Mounting



BM2813

Shock Mounting



LEFT

RIGHT

BMW

5 SERIES

REAR

E39(523.525.528.530.530D)

Year

1996-2004



BM1529
Link Stabilizer
L=66



BM1531
Link Stabilizer
L=66



BM1530
Link Stabilizer
L=93.5



BM1815
Upper Control Arm Bush



BM1720
Upper Control Arm



BM1721
Upper Control Arm

BM2128
Lower Control Arm Bush



BM2033
Lower Control Arm



BM2033
Lower Control Arm



BM2927
Bush



BM2928
Bush



LEFT

RIGHT

BMW

5 SERIES

FRONT

E39(540I.M5)

Year

1998-2004

BM1029
Outer Tie Rod End
(Ø12.7*Ø16.4/M16*1.5)



BM2214
Center Rod



BM1320
Outer Tie Rod End Set
(Ø12.7*Ø16.4/M16*1.5)

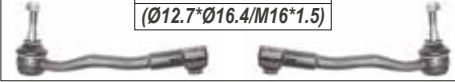

BM1030
Outer Tie Rod End
(Ø12.7*Ø16.4/M16*1.5)



BM1532
Link Stabilizer
L=285



BM1816
Upper Control Arm Bush



BM1722
Upper Control Arm

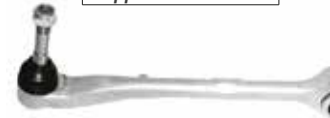

BM1723
Upper Control Arm

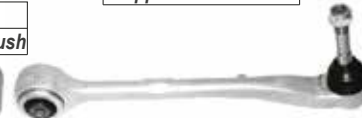

BM2127
Lower Control Arm Bush



BM2034
Lower Control Arm

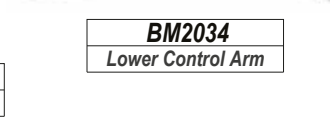

BM2035
Lower Control Arm

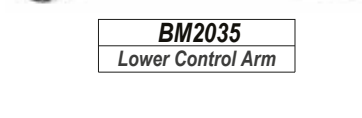

BM2819
Shock Mounting



BM2819
Shock Mounting



5 SERIES

REAR

BM1529
Link Stabilizer
L=66

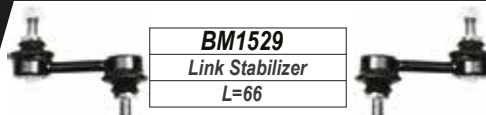

BM1530
Link Stabilizer
L=93.5

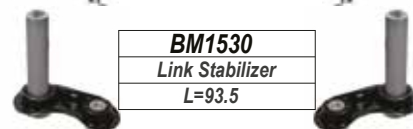

BM1815
Upper Control Arm Bush



BM1720
Upper Control Arm



BM1721
Upper Control Arm

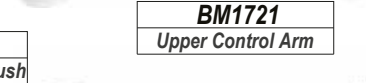

BM2128
Lower Control Arm Bush



BM2033
Lower Control Arm

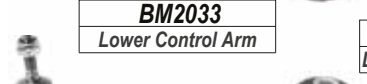

BM2033
Lower Control Arm

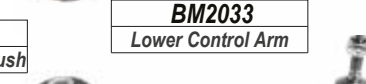

BM2129
Lower Control Arm Bush



BM2036
Lower Control Arm

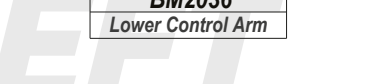

BM2036
Lower Control Arm

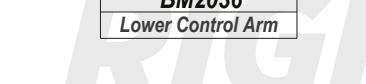

LEFT

RIGHT

BMW
5 SERIES
FRONT
E60

Year

2003-2010
BM1031

 Outer Tie Rod End
 (Ø16.2/M16*1.5)

BM1321

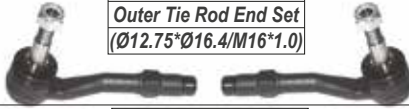
 Outer Tie Rod End Set
 (Ø12.75*Ø16.4/M16*1.0)

BM1031

 Outer Tie Rod End
 (Ø16.2/M16*1.5)

BM1416

 Rack End
 (18*1.5 /16*1.5/241)

BM1533 / BM1534

 Link Stabilizer
 L=300

BM1817

Upper Control Arm Bush

BM1724

Upper Control Arm

BM1725

Upper Control Arm

BM2127

Lower Control Arm Bush

BM2037

Lower Control Arm

BM2038

Lower Control Arm

BM2813

Shock Mounting

BM2813

Shock Mounting

5 SERIES
REAR
BM1818

Upper Control Arm Bush

BM1726

Upper Control Arm

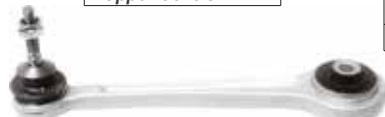
BM1727

Upper Control Arm

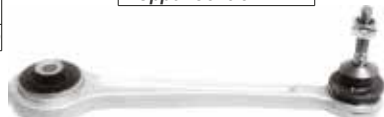
BM2128

Lower Control Arm Bush

BM2036

Lower Control Arm

BM2036

Lower Control Arm

BM1535

 Link Stabilizer
 L=102

BM1530

 Link Stabilizer
 L=93.5

BM2928

Bush

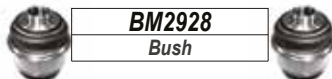
LEFT
RIGHT

BMW

5 SERIES

FRONT

F10. F11. F18

Year

2010-

BM1010
Outer Tie Rod End
(Ø16.4/M14*1.5)

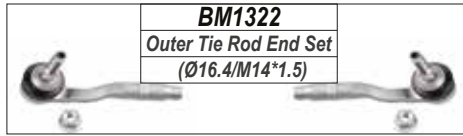

BM1322
Outer Tie Rod End Set
(Ø16.4/M14*1.5)

BM1426
Rack End
(18*1.5 /14*1.5/245)

BM1011
Outer Tie Rod End
(Ø16.4/M14*1.5)

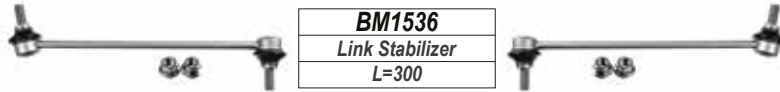

BM1536
Link Stabilizer
L=300



BM1728
Upper Control Arm

BM1819
Upper Control Arm Bush



BM1728
Upper Control Arm



BM1729
Upper Control Arm

BM1819
Upper Control Arm Bush



BM1729
Upper Control Arm



BM2039
Lower Control Arm

BM2130
Lower Control Arm Bush



BM2040
Lower Control Arm

LEFT

RIGHT

BMW		Year
5 SERIES	REAR	2010-
	F10. F11. F18	

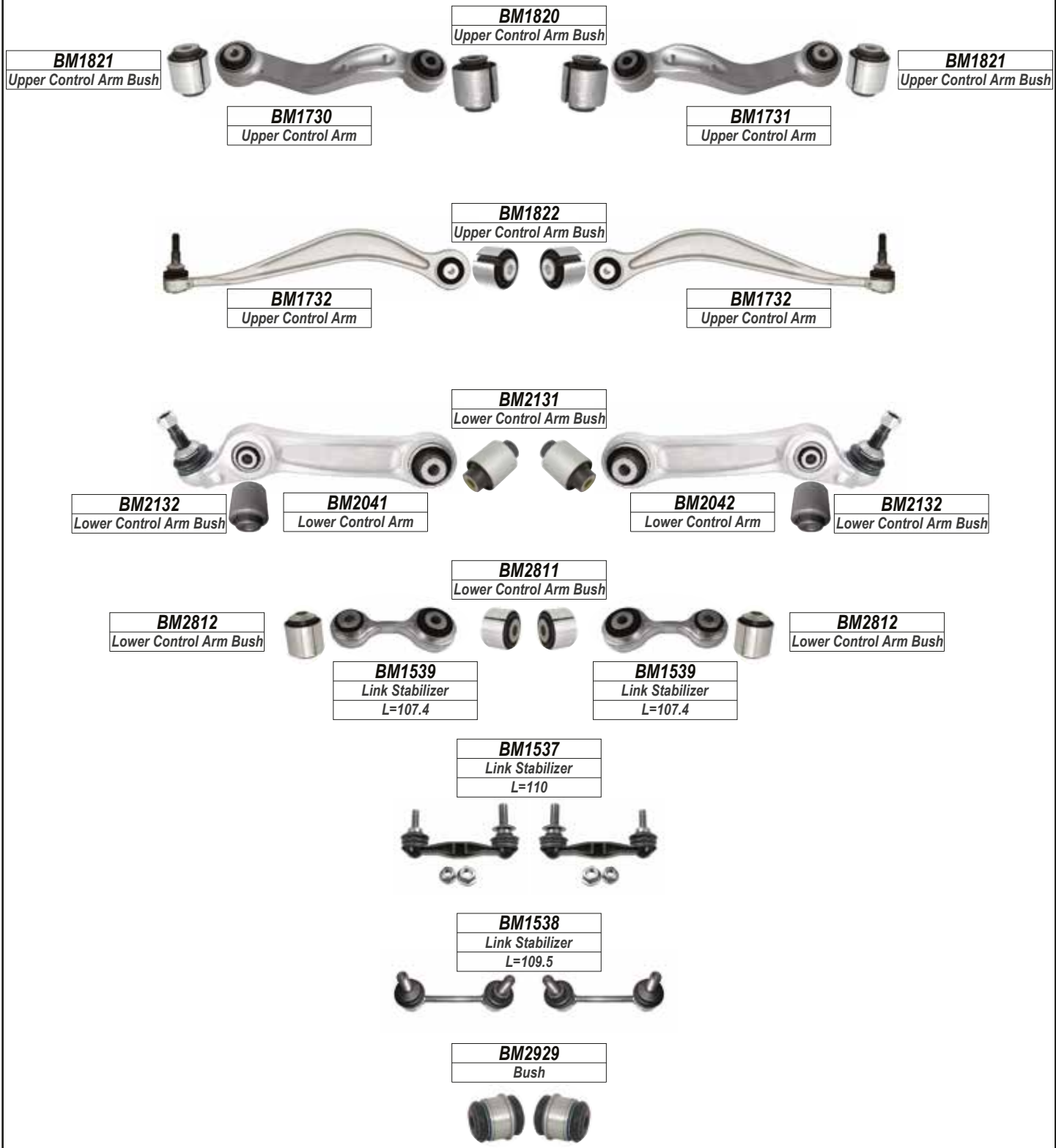

LEFT

RIGHT

BMW

5 SERIES

FRONT

F07(GRAN TURISMO)

Year

2009-

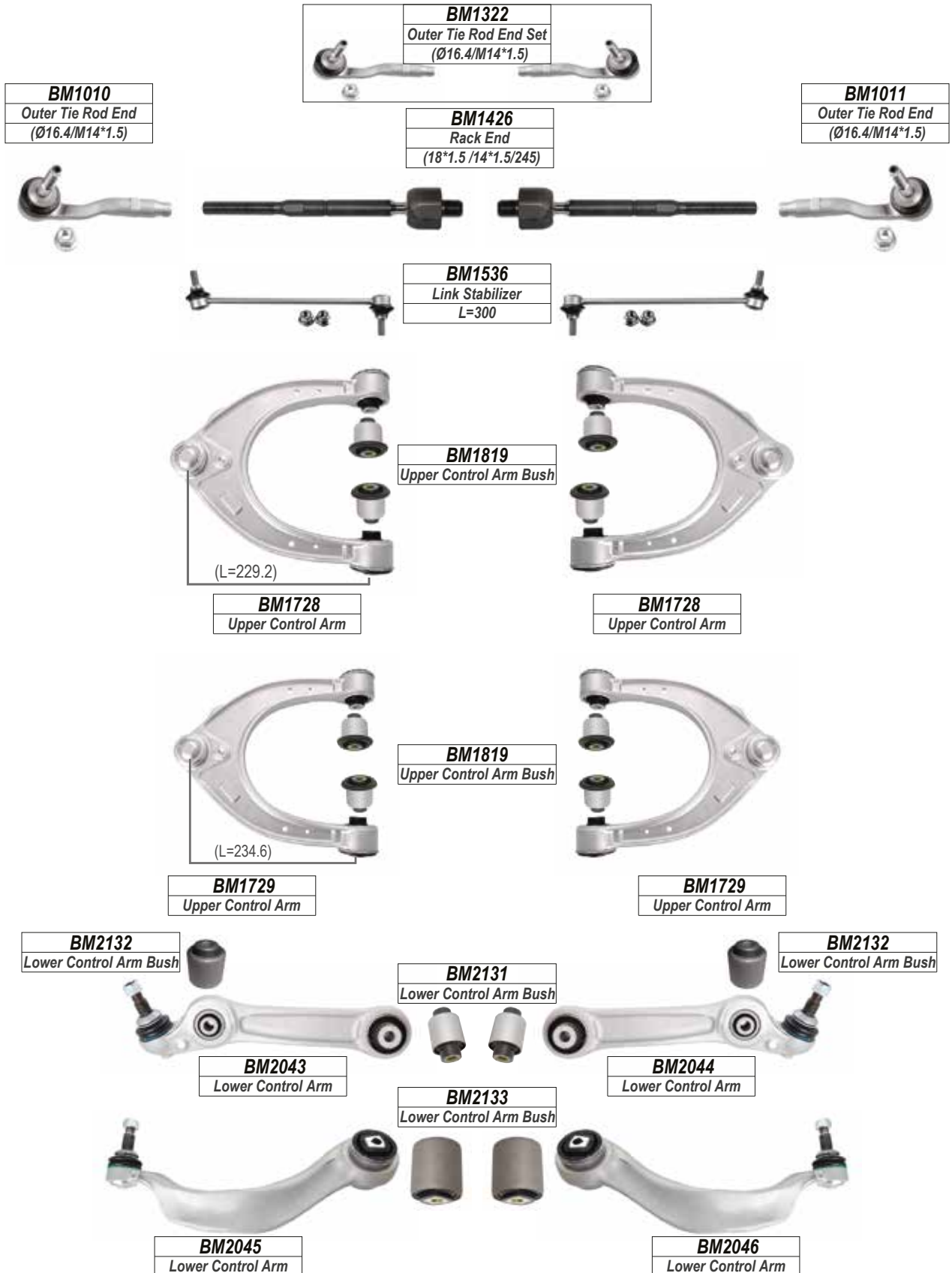

LEFT

RIGHT

BMW

5 SERIES

REAR

F07(GRAN TURISMO)

Year

2009-



LEFT

RIGHT

BMW

6 SERIES

FRONT

E24

Year

1980-1990

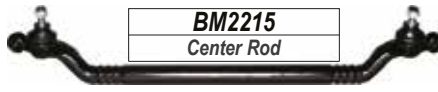

BM2215
Center Rod

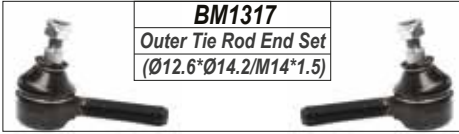

BM1317
Outer Tie Rod End Set
(Ø12.6*Ø14.2/M14*1.5)

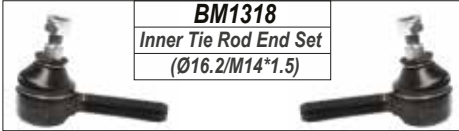

BM1318
Inner Tie Rod End Set
(Ø16.2/M14*1.5)

BM1026
Outer Tie Rod End
(Ø12.6*Ø14.2/M14*1.5)



BM1110
Inner Tie Rod End
(Ø12.6*Ø14.2/M14*1.5)



BM1110
Inner Tie Rod End
(Ø12.6*Ø14.2/M14*1.5)



BM1026
Outer Tie Rod End
(Ø12.6*Ø14.2/M14*1.5)



BM2211
Center Rod



BM2211
Center Rod

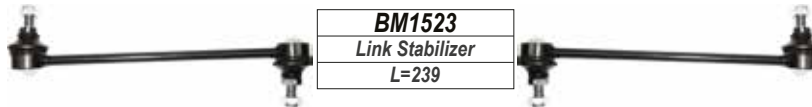

BM1523
Link Stabilizer
L=239



BM1812
Upper Control Arm Bush

BM1714
Upper Control Arm



BM2126
Lower Control Arm Bush



BM1715
Upper Control Arm



BM2029
Lower Control Arm



BM2030
Lower Control Arm



BM2924
Bush
(ID:Ø10.22/OD:Ø36/L=48)



BM2410
Idler Arm



BM2924
Bush
(ID:Ø10.22/OD:Ø36/L=48)

6 SERIES

REAR

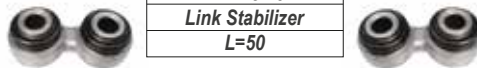

BM1526
Link Stabilizer
L=50

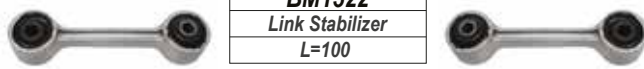

BM1522
Link Stabilizer
L=100

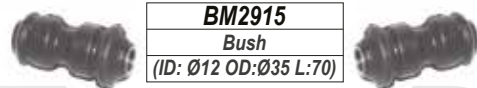

BM2915
Bush
(ID: Ø12 OD:Ø35 L:70)

LEFT

RIGHT

BMW

6 SERIES

FRONT

E63.E64

Year

2004-2011

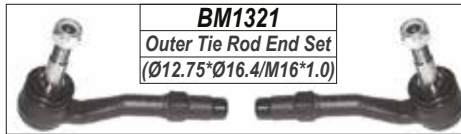

BM1321
Outer Tie Rod End Set
(Ø12.75*Ø16.4/M16*1.0)

BM1031
Outer Tie Rod End
(Ø16.2/M16*1.5)

BM1416
Rack End
(18*1.5 /16*1.5/241)

BM1031
Outer Tie Rod End
(Ø16.2/M16*1.5)



BM1541 / BM1542
Link Stabilizer
L=332

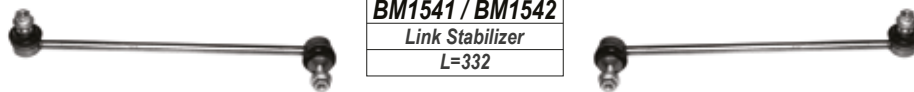

BM1823
Upper Control Arm Bush



BM1739
Upper Control Arm

BM1740
Upper Control Arm



BM2127
Lower Control Arm Bush

BM2049
Lower Control Arm

BM2050
Lower Control Arm

BM2813
Shock Mounting



BM2813
Shock Mounting



5 SERIES

REAR

BM1818
Upper Control Arm Bush



BM1726
Upper Control Arm

BM1727
Upper Control Arm

BM1530
Link Stabilizer
L=93.5

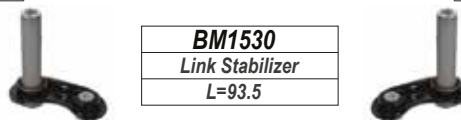

BM1535
Link Stabilizer
L=102



LEFT

RIGHT

BMW

6 SERIES

FRONT

F12.F13 COUPE

Year

2011-

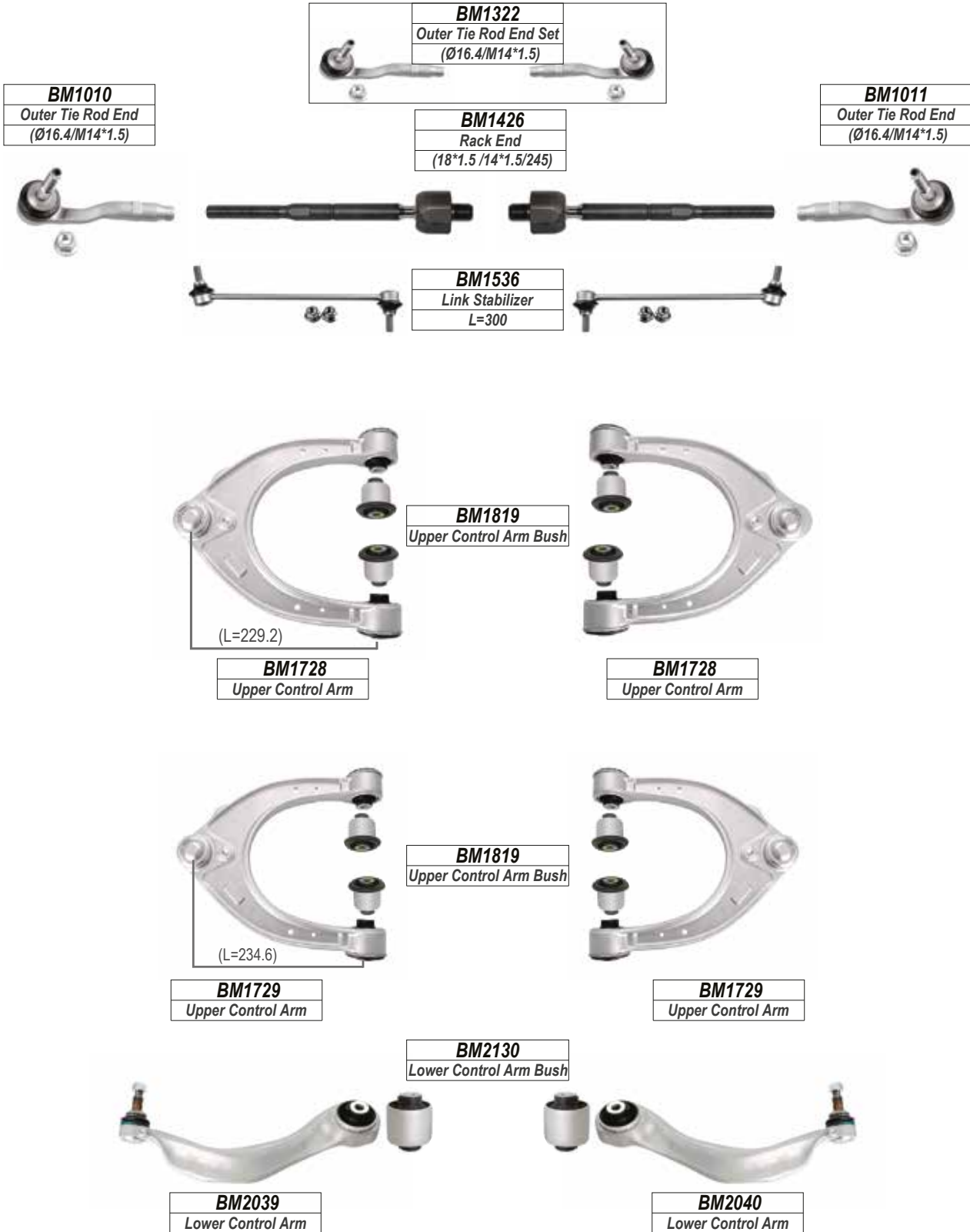

LEFT

RIGHT

BMW		Year
6 SERIES	REAR	2011-
	F12.F13 COUPE	

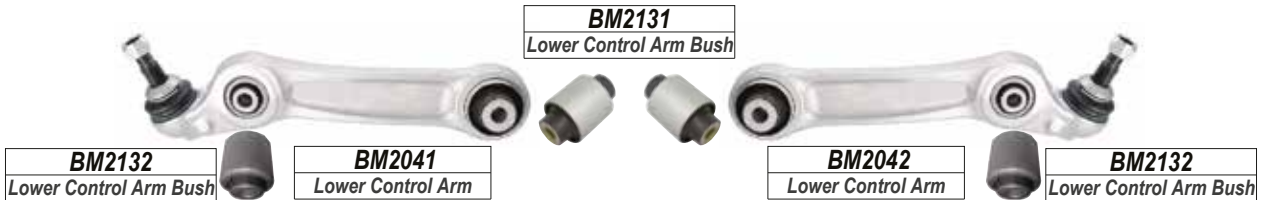

LEFT

RIGHT

BMW

7 SERIES

FRONT

E32

Year

1986-1994

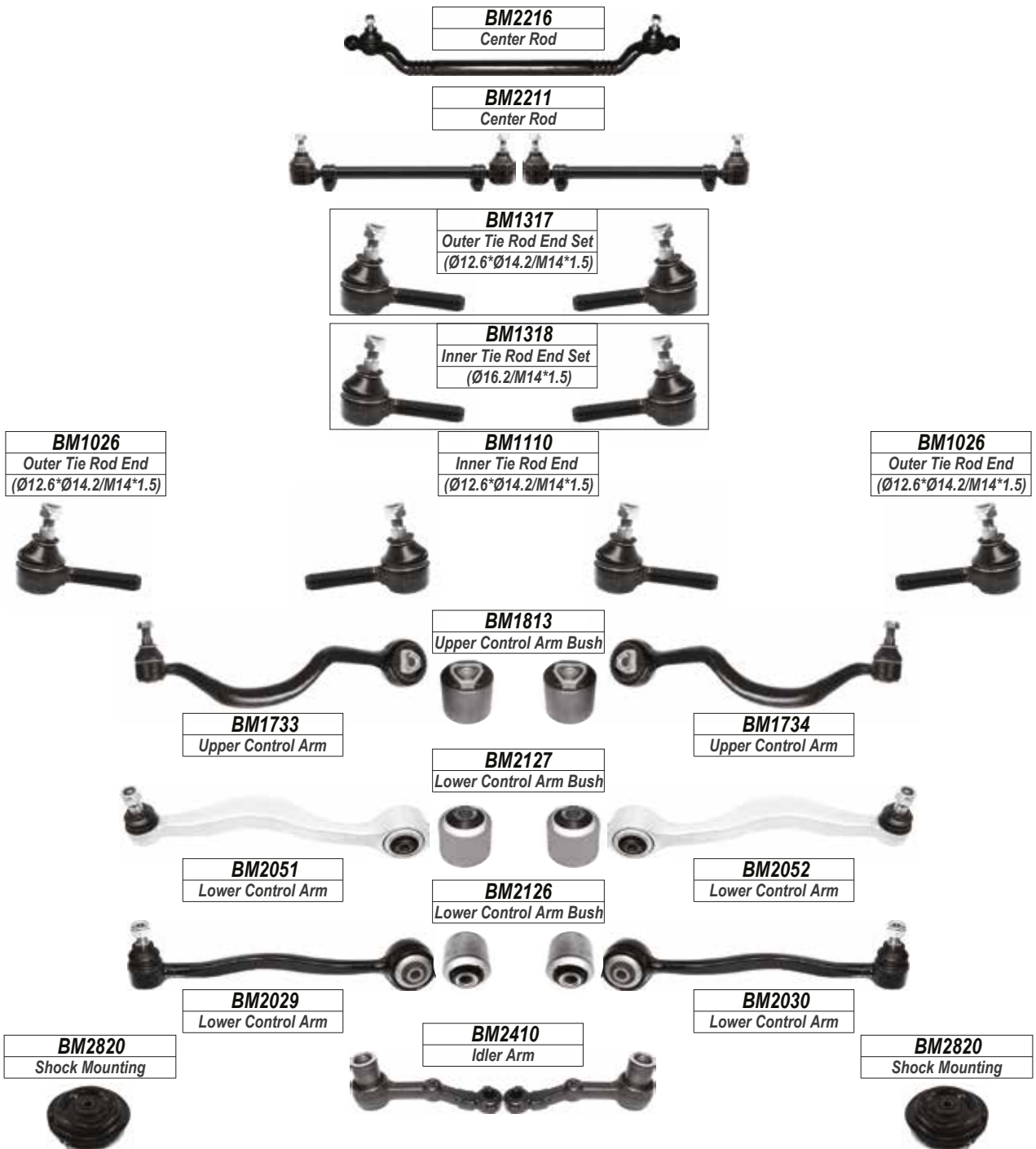

7 SERIES

REAR

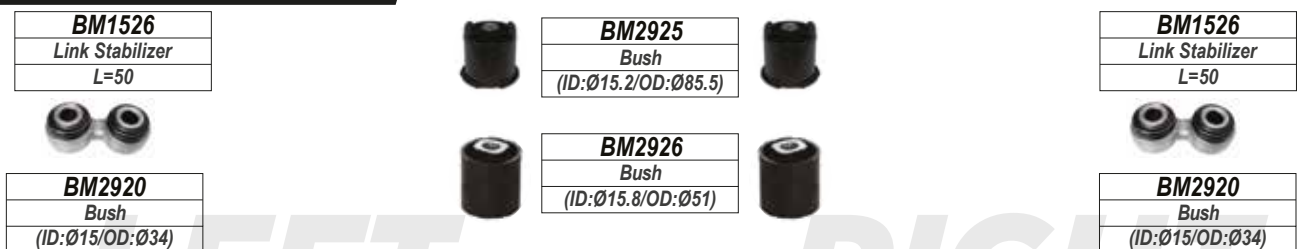

LEFT

RIGHT

BMW

7 SERIES

FRONT

E38

Year

1994-2003

BM1032
Outer Tie Rod End
(Ø14.6*Ø16.6/M16*1.5)



BM2217
Center Rod



BM1323
Outer Tie Rod End Set
(Ø14.6*Ø16.6/M16*1.5)



BM1033
Outer Tie Rod End
(Ø14.6*Ø16.6/M16*1.5)



BM1543
Link Stabilizer
L=308

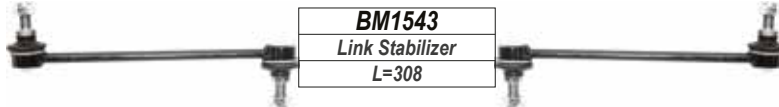

BM1816
Upper Control Arm Bush



BM1735
Upper Control Arm



BM1736
Upper Control Arm

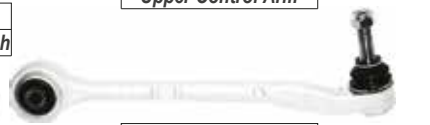

BM2127
Lower Control Arm Bush



BM2053
Lower Control Arm



BM2054
Lower Control Arm



BM2821
Shock Mounting



BM2924
Bush
(ID:Ø10.22/OD:Ø36/L=48)

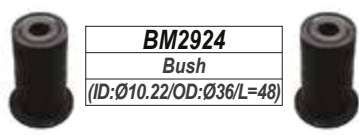

BM2821
Shock Mounting



7 SERIES

REAR



BM1737
Upper Control Arm



BM1738
Upper Control Arm



BM2128
Lower Control Arm Bush



BM2033
Lower Control Arm

BM2928
Bush



BM2033
Lower Control Arm

BM2928
Bush



BM1544
Link Stabilizer
L=75

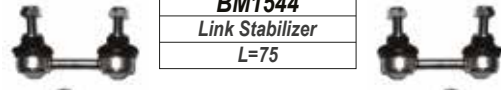

BM2930
Bush



BM1530
Link Stabilizer
L=93.5

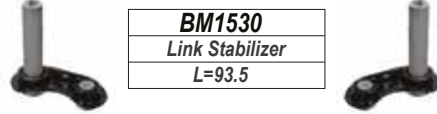

BM2930
Bush



LEFT

RIGHT

BMW

7 SERIES

FRONT

E65.E66

Year

2001-2008

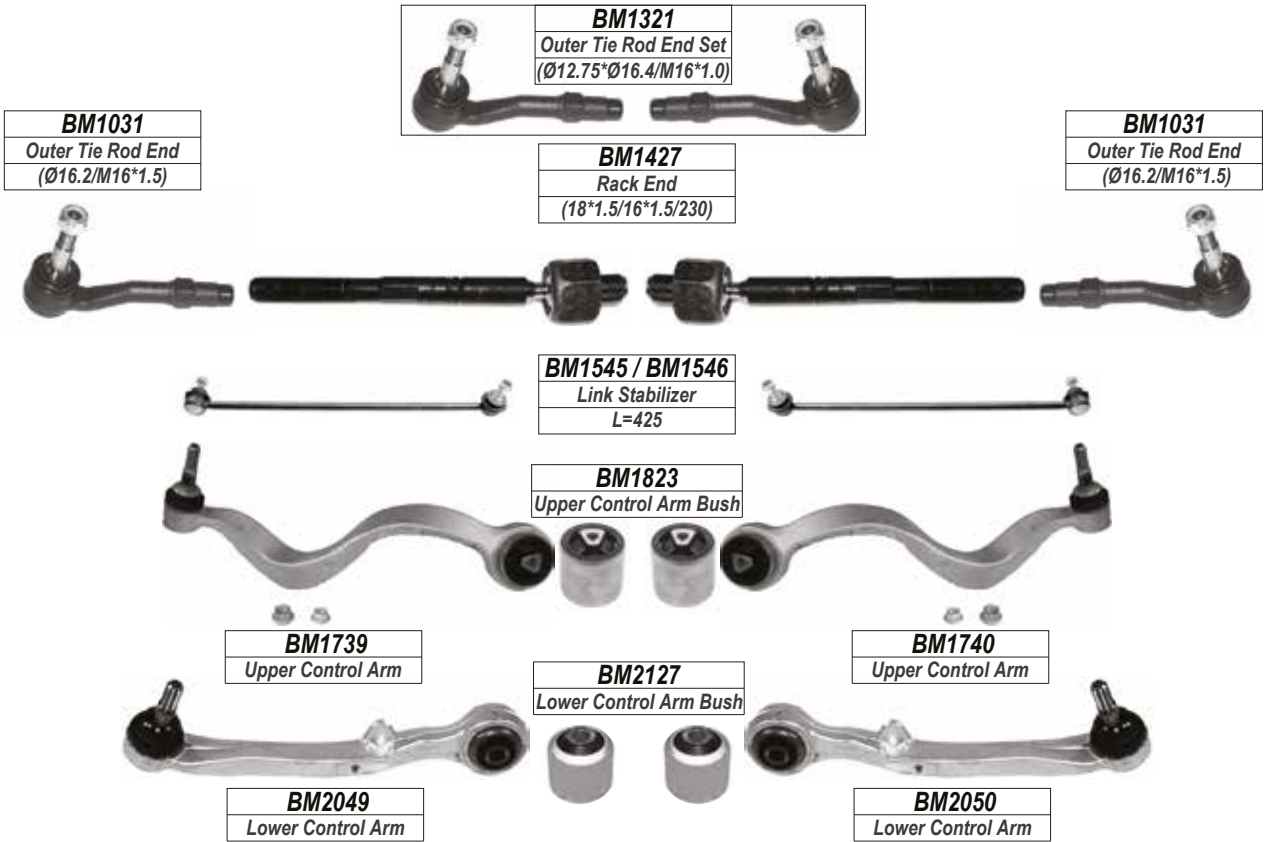

5 SERIES

REAR



LEFT

RIGHT

BMW

7 SERIES

FRONT

F01.F02.F03.F04

Year

2008-

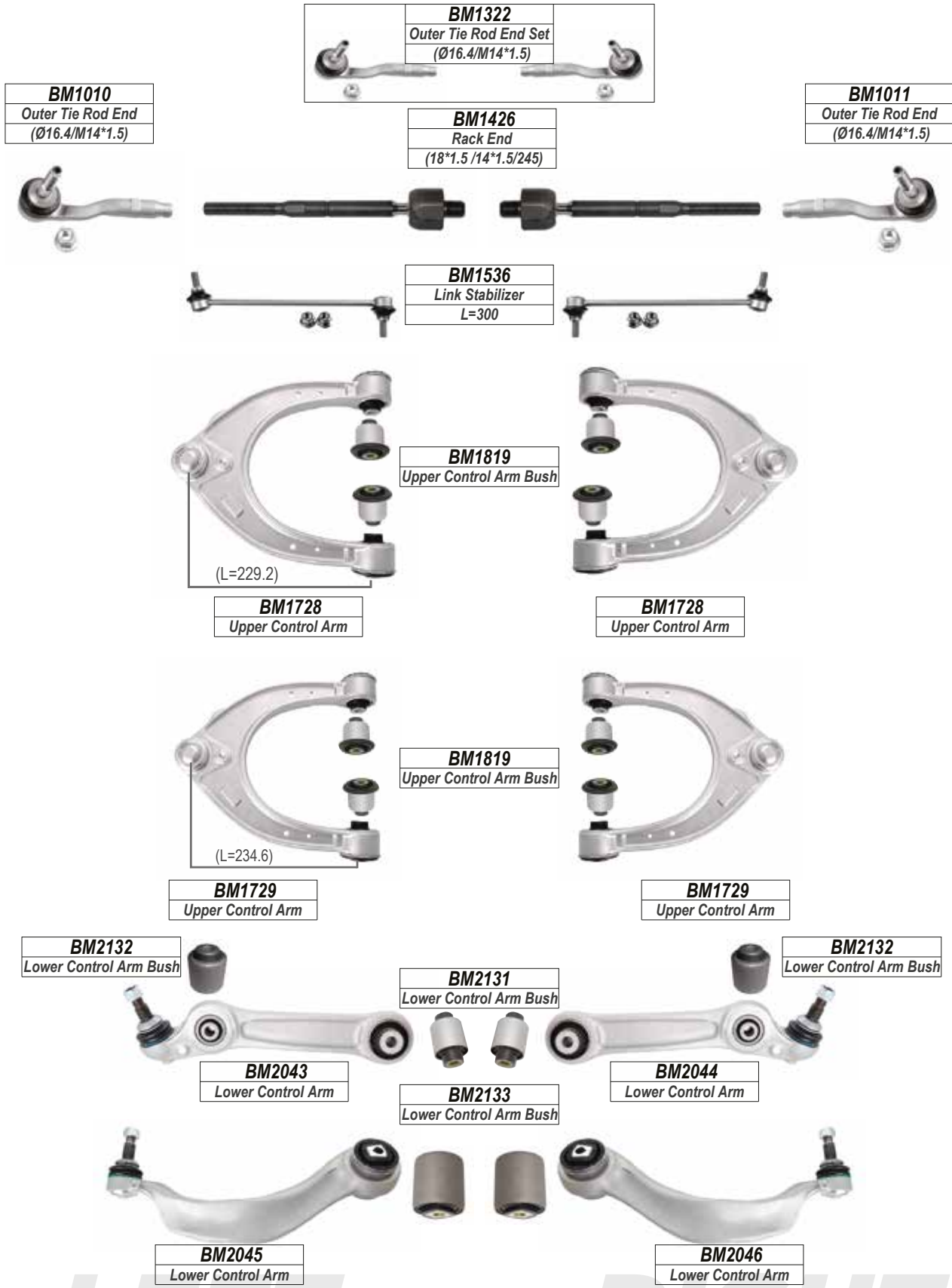

LEFT

RIGHT

BMW

7 SERIES

FRONT

F01.F02.F03.F04

Year

2008-



LEFT

RIGHT

BMW

i3

FRONT

101

Year

2013-

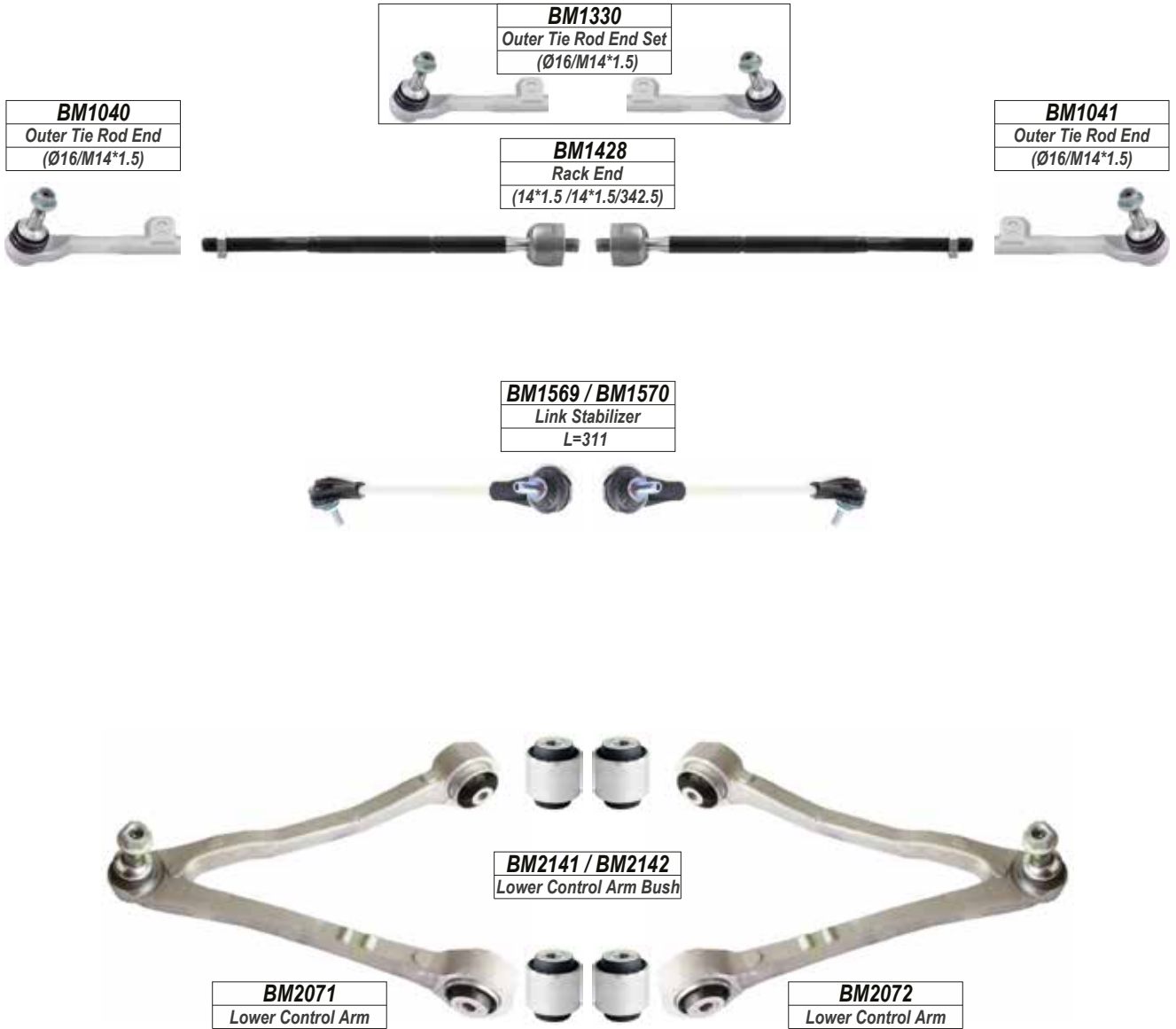

LEFT

RIGHT

BMW

X1

FRONT

E84.E84 XD

Year

2009-2015

BM1013
Outer Tie Rod End
(Ø15.7/M14*1.5)

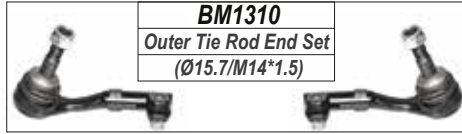

BM1310
Outer Tie Rod End Set
(Ø15.7/M14*1.5)

BM1417
Rack End
(18*1.5 /14*1.5/259)

BM1014
Outer Tie Rod End
(Ø15.7/M14*1.5)



BM1510 / BM1511
Link Stabilizer
L=290

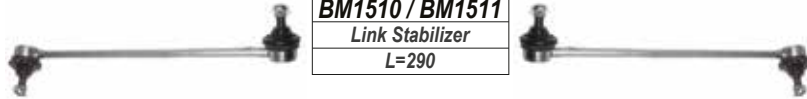

BM1512 / BM1513
Link Stabilizer
L=290(Al.)

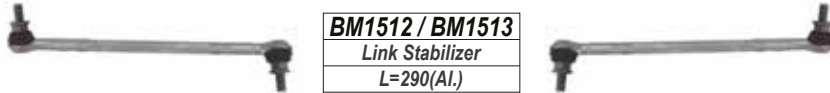

BM1550 / BM1551
Link Stabilizer
L=340(Al.)(XD Only)

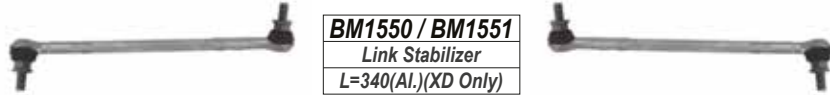

BM1810
Upper Control Arm Bush



BM1710
Upper Control Arm

BM2110
Lower Control Arm Bush

BM1711
Upper Control Arm



BM2010
Lower Control Arm

BM2011
Lower Control Arm



BM1612
Upper Ball Joint
(Ø17.9)

BM1612
Upper Ball Joint
(Ø17.9)

BM1741
Upper Control Arm
XD Only

BM1742
Upper Control Arm
XD Only



BM2124
Lower Control Arm Bush

BM2022
Lower Control Arm
XD Only

BM2022
Lower Control Arm
XD Only



BM2813
Shock Mounting



BM2813
Shock Mounting



LEFT

RIGHT

BMW		Year	
X1	REAR	E84.E84 XD	2009-2015

BM1517 / BM1518
Link Stabilizer
L=135



BM2910
Bush

BM2910
Bush



BM2910
Bush

BM2611
Lateral Link
L=413.5

BM2611
Lateral Link
L=413.5

BM2911
Bush

BM2913
Bush



BM2913
Bush

BM2612
Lateral Link
L=273

BM2612
Lateral Link
L=273

BM2912
Bush

BM2913
Bush



BM2913
Bush

BM2613
Lateral Link
L=240

BM2613
Lateral Link
L=240

LEFT

RIGHT

BMW

X1

FRONT

F48

Year

2015-

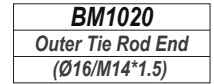
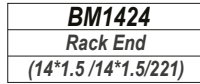
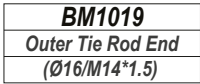

LEFT

RIGHT

BMW

X2

FRONT

F39

Year

2017-

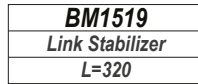
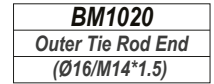
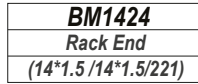
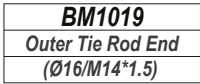
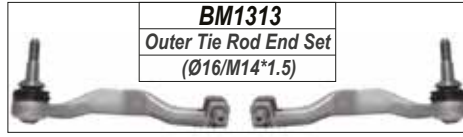

LEFT

RIGHT

BMW

X3

FRONT

E83

Year

2004-2010

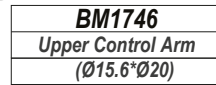
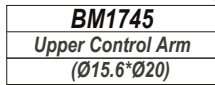
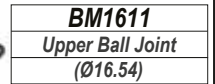
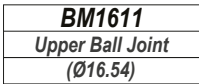
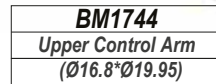
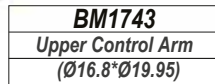
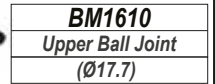
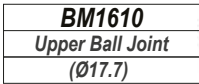
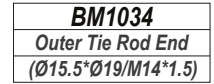
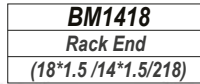
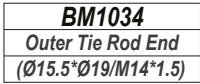
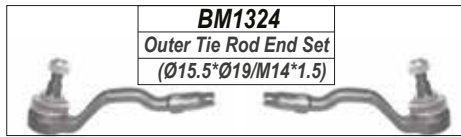

X3

REAR

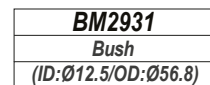
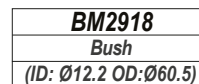
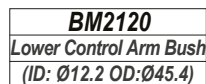
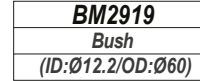
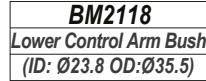

LEFT

RIGHT

BMW			Year
X3	FRONT	F25	2010-

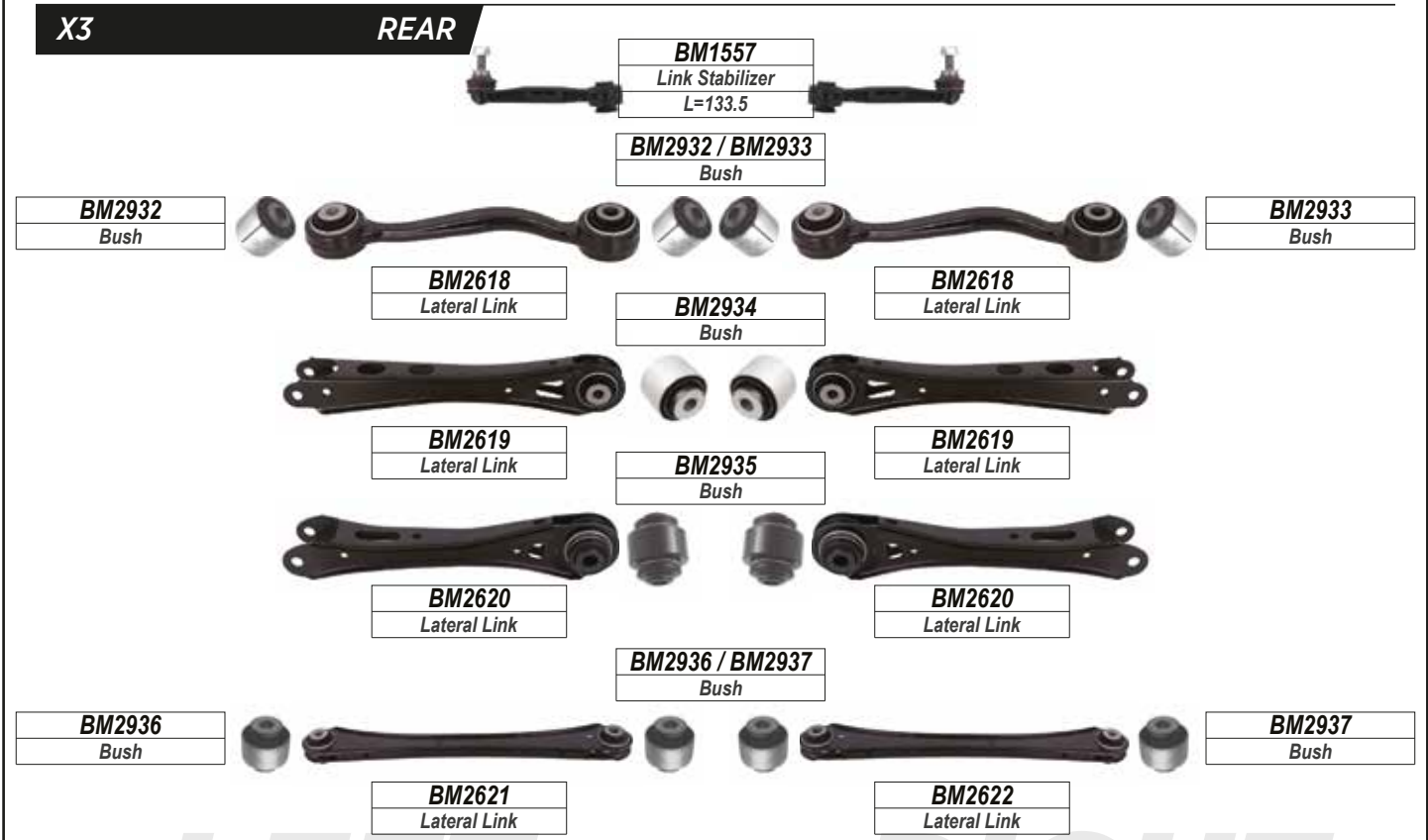
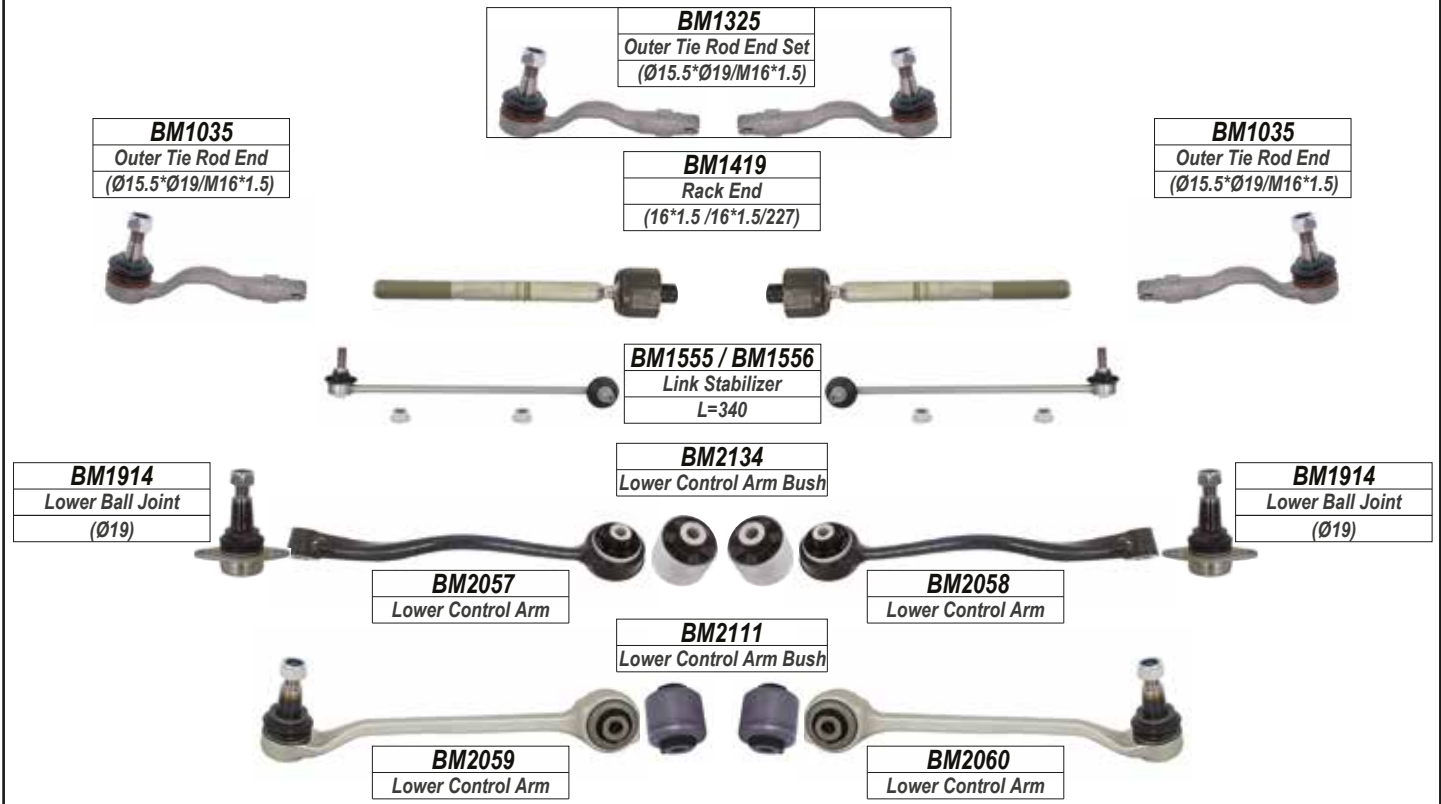

LEFT

RIGHT

BMW			Year
X4	FRONT	F26	2014-

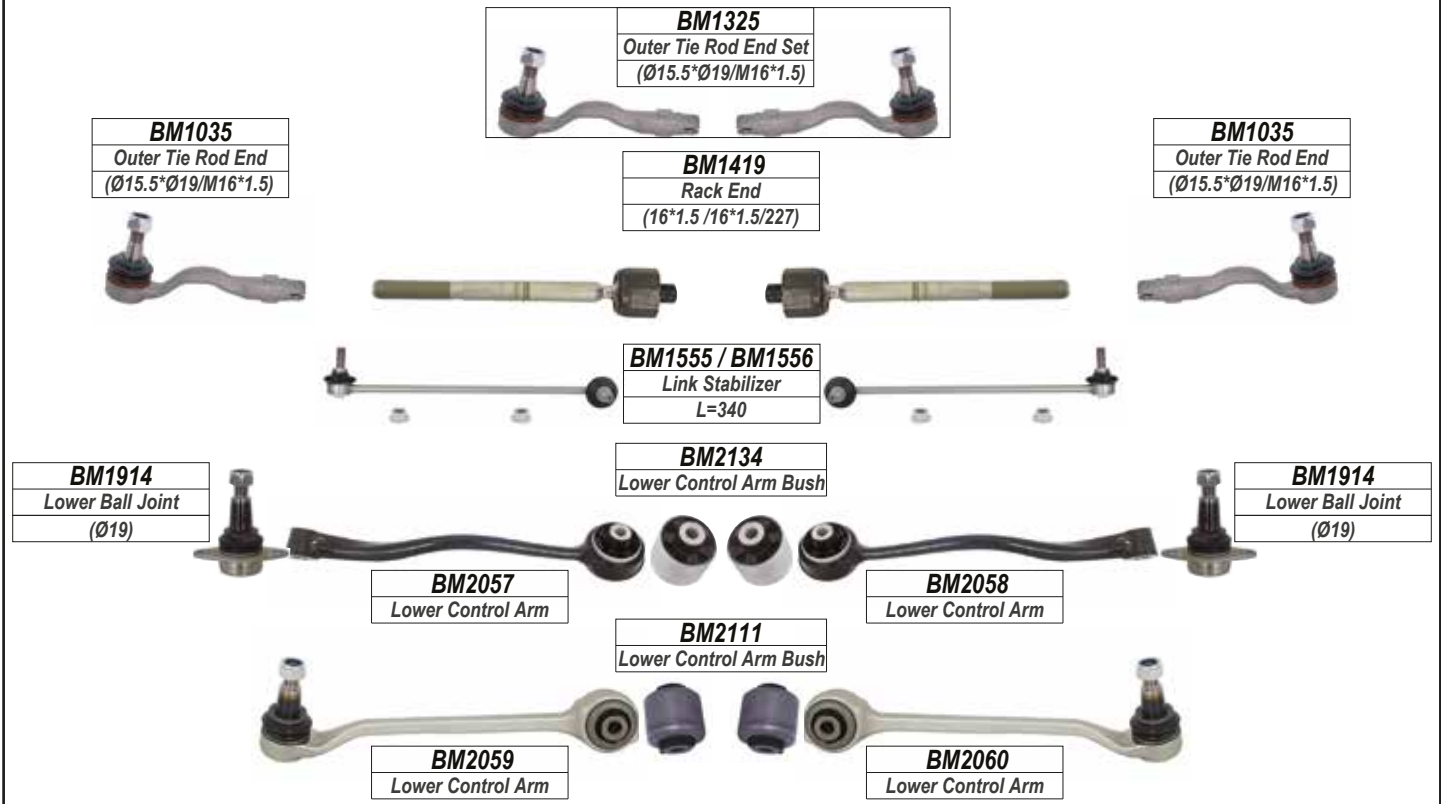

X4 **REAR**

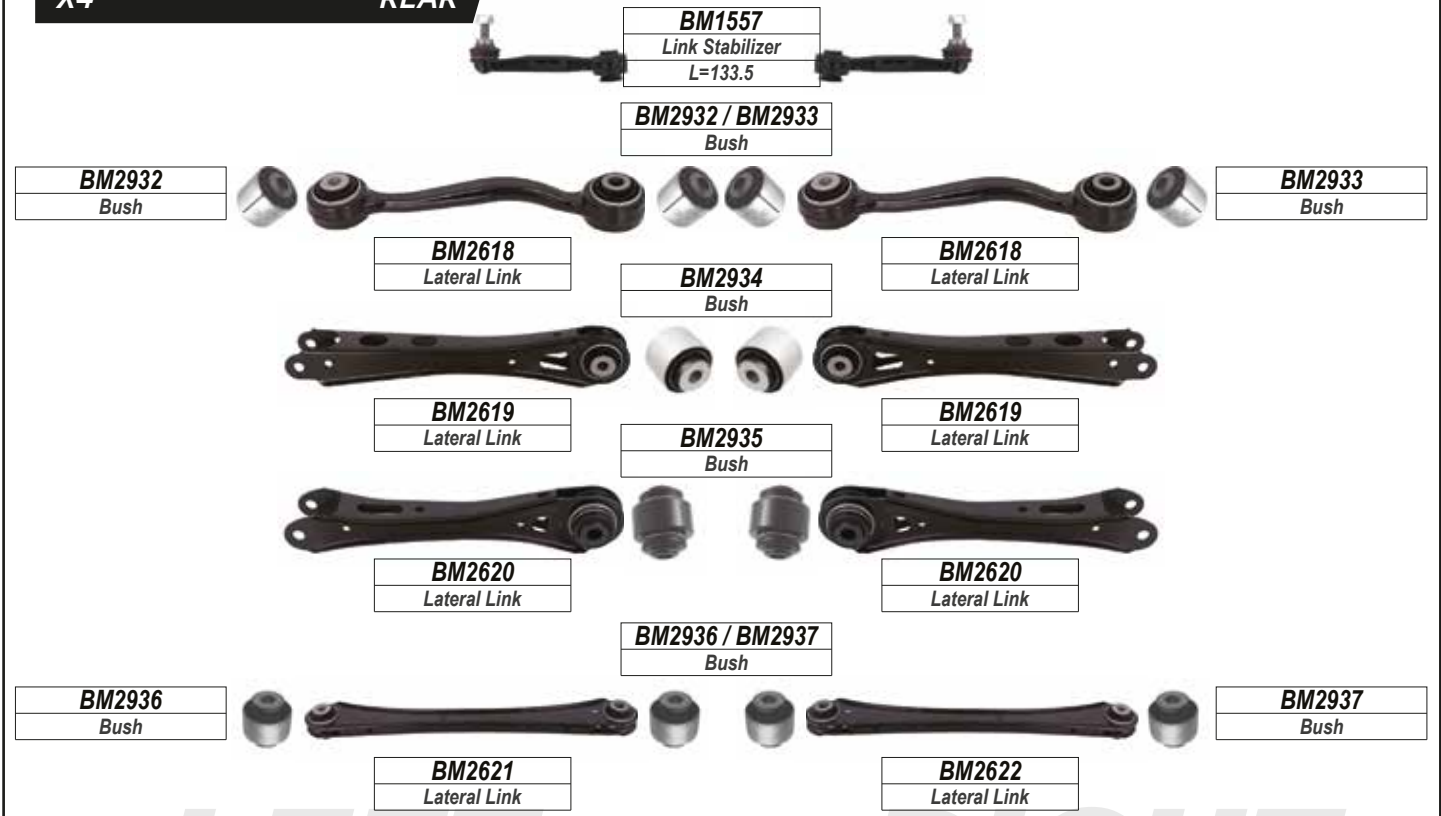

LEFT

RIGHT

BMW

X5

FRONT

E53

Year

2000-2007

BM1036
Outer Tie Rod End
(Ø15.4*Ø18.3/M14*1.5)



BM1037
Outer Tie Rod End
(Ø15.4*Ø18.4/M14*1.5)



BM1326
Outer Tie Rod End Set
(Ø15.4*Ø18.3/M14*1.5)



BM1327
Outer Tie Rod End Set
(Ø15.4*Ø18.4/M14*1.5)

BM1420
Rack End
(18*1.5 /14*1.5/220)



BM1036
Outer Tie Rod End
(Ø15.4*Ø18.3/M14*1.5)



BM1037
Outer Tie Rod End
(Ø15.4*Ø18.4/M14*1.5)



BM1558 / BM1559
Link Stabilizer
L=359

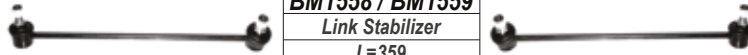

BM1824
Upper Control Arm Bush



BM1612
Upper Ball Joint
(Ø17.9)



BM1747
Upper Control Arm



BM1748
Upper Control Arm



BM1612
Upper Ball Joint
(Ø17.9)



BM2126
Lower Control Arm Bush



BM2822
Shock Mounting



BM2061
Lower Control Arm



BM2062
Lower Control Arm



BM2822
Shock Mounting



X5

REAR

BM1825
Upper Control Arm Bush



BM2823
Shock Mounting



BM1749
Upper Control Arm



BM1749
Upper Control Arm



BM2823
Shock Mounting



BM2623
Lateral Link



BM2624
Lateral Link



BM2928
Bush



BM1560
Link Stabilizer
L=65

BM2928
Bush

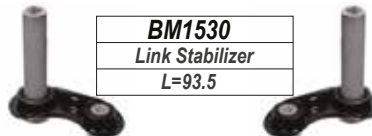

BM1530
Link Stabilizer
L=93.5

LEFT

RIGHT

BMW

X5

FRONT

E70. X-DRIVE

Year

2007-2014

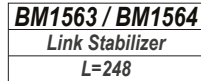
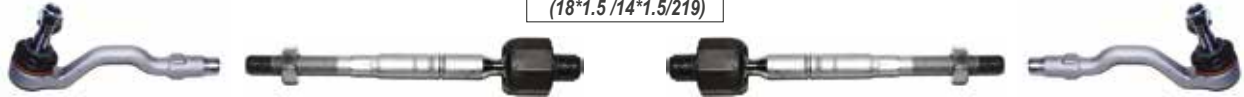
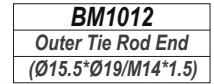
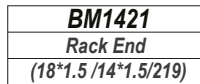
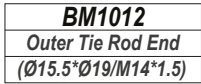
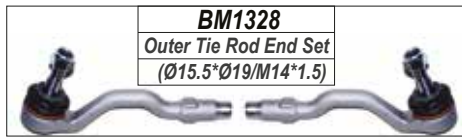

LEFT

RIGHT

BMW

X5

REAR

E70. X-DRIVE

Year

2007-2014



BM2825
Shock Mounting



BM2825
Shock Mounting



LEFT

RIGHT

BMW

X5

FRONT

F15

Year

2014-

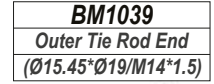
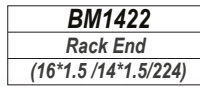
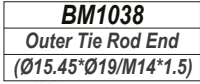
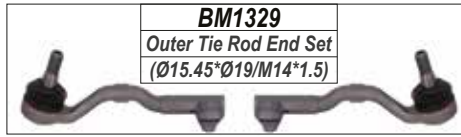

LEFT

RIGHT

BMW

X5

REAR

F15

Year

2014-



LEFT

RIGHT

BMW

X6

FRONT

E71

Year

2009-2014

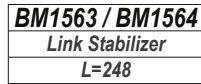
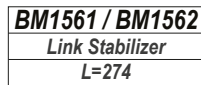
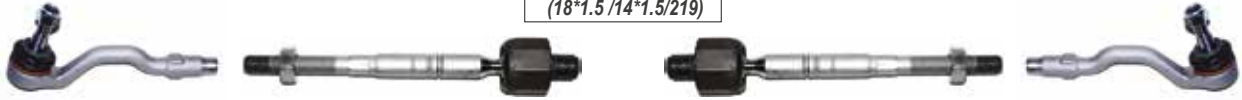
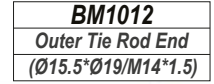
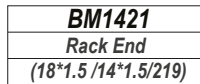
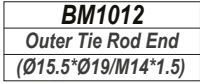
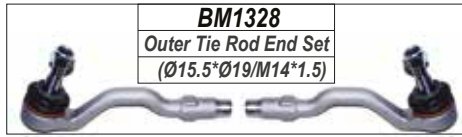

LEFT

RIGHT

BMW

X6

REAR

E71

Year

2009-2014



LEFT

RIGHT

BMW

X6

FRONT

F16

Year

2014-

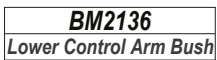
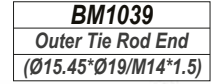
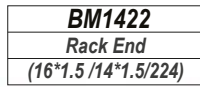
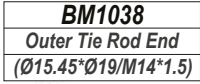
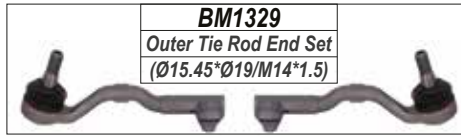

LEFT

RIGHT

BMW

X6

REAR

F16

Year

2014-



LEFT

RIGHT

CAM

INYATHI

FRONT

P/VAN.BUS

Year

2006-

CA1010
Outer Tie Rod End
(Ø14.6*Ø16.5/M17*1.5)

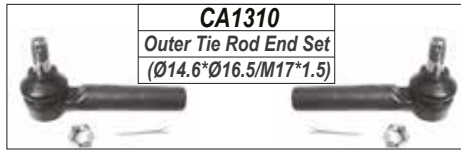

CA1310
Outer Tie Rod End Set
(Ø14.6*Ø16.5/M17*1.5)

CA1010
Outer Tie Rod End
(Ø14.6*Ø16.5/M17*1.5)



CA1410
Rack End
(14*1.5/17*1.5/276)



CA1011
Outer Tie Rod End
(Ø14.7*Ø16/M15*1.5)

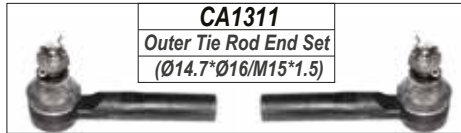

CA1311
Outer Tie Rod End Set
(Ø14.7*Ø16/M15*1.5)

CA1011
Outer Tie Rod End
(Ø14.7*Ø16/M15*1.5)



CA1411
Rack End
(14*1.5/15*1.5/274)



CA1611
Upper Ball Joint
(Ø17.5)



CA1611
Upper Ball Joint
(Ø17.5)



CA1910
Lower Ball Joint
(Ø18)



CA2010
Lower Control Arm



CA2011
Lower Control Arm

CA1910
Lower Ball Joint
(Ø18)



LEFT

RIGHT

CAM

RHINO

FRONT

2.2

Year

2007-

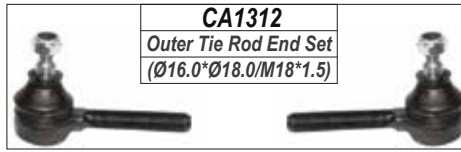

CA1012
Outer Tie Rod End
(Ø16.0*Ø18.0/M18*1.5)



CA1110
Inner Tie Rod End
(Ø16.0*Ø18.0/M18*1.5)



CA1012
Outer Tie Rod End
(Ø16.0*Ø18.0/M18*1.5)



CA1610
Upper Ball Joint
(Ø17)



CA1710
Upper Control Arm



CA1710
Upper Control Arm



CA1610
Upper Ball Joint
(Ø17)

CA1911
Lower Ball Joint
(Ø18)



CA2012
Lower Control Arm



CA2013
Lower Control Arm



CA1911
Lower Ball Joint
(Ø18)



CA2110
Lower Control Arm Bush

LEFT

RIGHT

CHANA

Year

STAR

FRONT

ALL

2006-

CN1410
Rack End
(14*1.5/17*1.5/276)



CN1910
Lower Ball Joint
(Ø18)



CN1910
Lower Ball Joint
(Ø18)



LEFT

RIGHT

CHERY

QQ3

FRONT

0.8.1.0

Year

2008-

CY1010
Outer Tie Rod End
(Ø12.6*Ø14.5/M12*1.5)

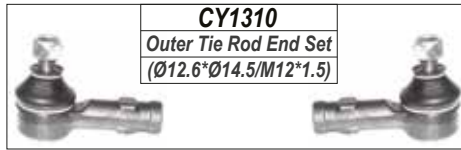

CY1310
Outer Tie Rod End Set
(Ø12.6*Ø14.5/M12*1.5)

CY1410
Rack End
(16*1.5/12*1.5/250)



CY1010
Outer Tie Rod End
(Ø12.6*Ø14.5/M12*1.5)



CY2010
Lower Control Arm



CY2010
Lower Control Arm

LEFT

RIGHT

CHERY

TIGGO

FRONT

1.6.2.0

Year

2008-

CY1011
Outer Tie Rod End
(Ø12.5*Ø15/M15*1.5)

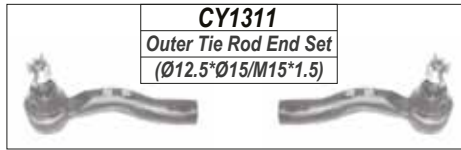

CY1012
Outer Tie Rod End
(Ø12.5*Ø15/M15*1.5)

CY1411
Rack End
(14*1.5/15*1.5/298)



CY1510
Link Stabilizer
L=285



CY1910
Lower Ball Joint
(Ø15)



CY2011
Lower Control Arm



CY2012
Lower Control Arm

CY1910
Lower Ball Joint
(Ø15)



TIGGO

REAR

CY1511 / CY1512
Link Stabilizer
L=100



LEFT

RIGHT

CHEVROLET

AVEO

FRONT

1.0 LS.LT.1.5 LS.LT.T200.T250

Year

2003-2011

CH1010
Outer Tie Rod End
(Ø13.2*Ø15/M12*1.5)

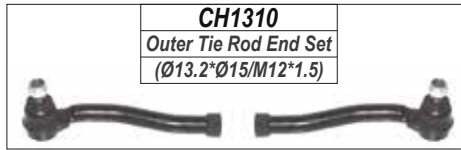

CH1310
Outer Tie Rod End Set
(Ø13.2*Ø15/M12*1.5)

CH1011
Outer Tie Rod End
(Ø13.2*Ø15/M12*1.5)



CH1410
Rack End
(16*1.5 /12*1.5/200)



CH1510
Link Stabilizer
L=261



CH1911
Lower Ball Joint
(Ø14.9)



CH2111
Lower Control Arm Bush



CH1911
Lower Ball Joint
(Ø14.9)



CH2010
Lower Control Arm



CH2011
Lower Control Arm



CH2110
Lower Control Arm Bush



CH2810
Shock Mounting



CH2810
Shock Mounting



AVEO

REAR

CH1511
Link Stabilizer
L=247



LEFT

RIGHT

CHEVROLET

AVEO

FRONT

T300

Year

2011-

CH1012
Outer Tie Rod End
(Ø13.2*Ø15.1/M14*1.5)

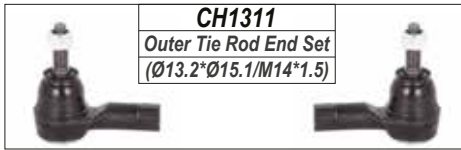

CH1311
Outer Tie Rod End Set
(Ø13.2*Ø15.1/M14*1.5)

CH1411
Rack End
(16*1.5 /14*1.5/328)

CH1012
Outer Tie Rod End
(Ø13.2*Ø15.1/M14*1.5)

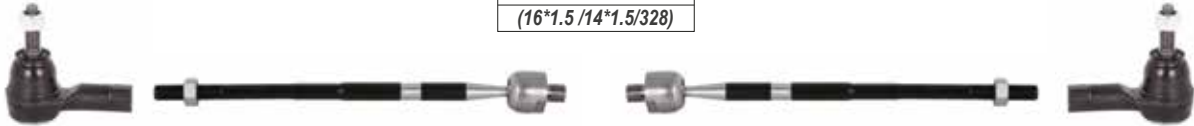

OP1421
Rack End
(14*1.5/14*1.5/334)



CH1512
Link Stabilizer
L=295



CH2112
Lower Control Arm Bush

CH1912
Lower Ball Joint
(Ø14.9)



CH2012
Lower Control Arm



CH2013
Lower Control Arm

CH1912
Lower Ball Joint
(Ø14.9)



CH2113
Lower Control Arm Bush

LEFT

RIGHT

CHEVROLET

CAPTIVA

FRONT

Year

2.0.2.2.2.4LPG.3.0.3.2.C100.C140

2007-2011

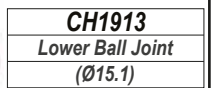
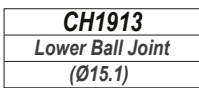

CAPTIVA

REAR



LEFT

RIGHT

CHEVROLET

CAPTIVA

FRONT

2.2D.2.4.3.0

Year

2011-

CH1413
<i>Rack End</i>
(16*1.5/14*1.5/328)



CH1914
<i>Lower Ball Joint</i>
(Ø15)



CH1914
<i>Lower Ball Joint</i>
(Ø15)



LEFT

RIGHT

CHEVROLET

CRUZE

FRONT

1.6.1.8.2.0CDI.J300

Year

2009-2012

CH1014
Outer Tie Rod End
(Ø13.1*Ø18.1/M16*1.5)

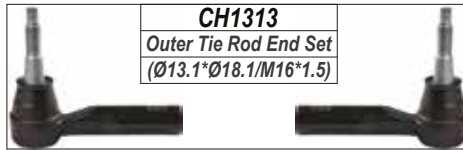

CH1313
Outer Tie Rod End Set
(Ø13.1*Ø18.1/M16*1.5)

CH1014
Outer Tie Rod End
(Ø13.1*Ø18.1/M16*1.5)



CH1414
Rack End
(16*1.5 /16*1.5/294)



CH1516
Link Stabilizer
L=304

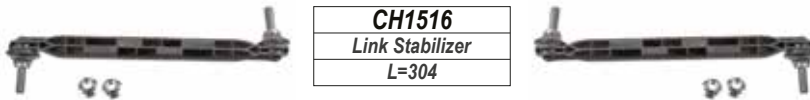

CH2116
Lower Control Arm Bush



CH2016
Lower Control Arm

CH2017
Lower Control Arm

CH2117
Lower Control Arm Bush



CH2117
Lower Control Arm Bush

CH2018
Lower Control Arm

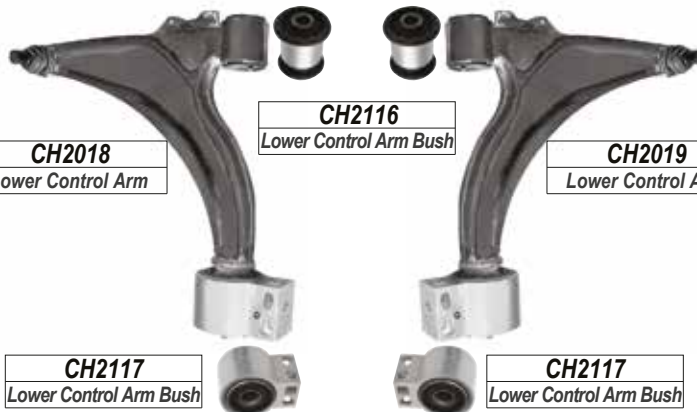

CH2116
Lower Control Arm Bush

CH2019
Lower Control Arm

CH2812
Shock Mounting



CH2812
Shock Mounting



CH2117
Lower Control Arm Bush



CH2117
Lower Control Arm Bush

CRUZE

REAR

CH2813
Shock Mounting



CH2813
Shock Mounting



LEFT

RIGHT

CHEVROLET

OPTRA

FRONT

1.6.LS.1.8LT

Year

2004-

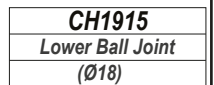
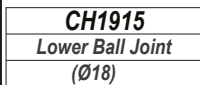
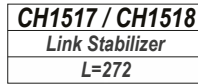
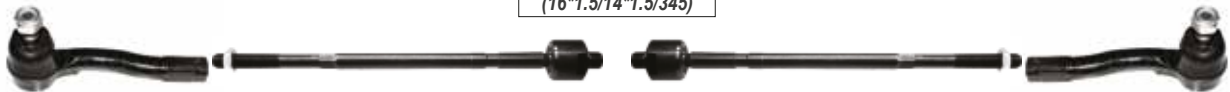
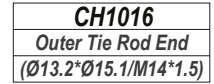
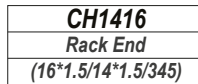
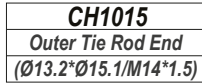
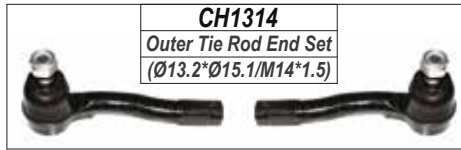

OPTRA

REAR



LEFT

RIGHT

CHEVROLET

ORLANDO

FRONT

1.8

Year

2011-

CH1014
Outer Tie Rod End
(Ø13.1*Ø18.1/M16*1.5)

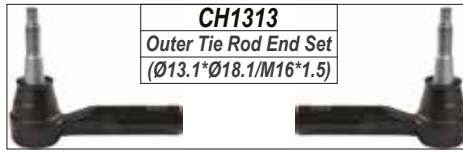

CH1313
Outer Tie Rod End Set
(Ø13.1*Ø18.1/M16*1.5)

CH1417
Rack End
(16*1.5 /16*1.5/310)



CH1014
Outer Tie Rod End
(Ø13.1*Ø18.1/M16*1.5)



CH1516
Link Stabilizer
L=304



CH2018
Lower Control Arm



CH2116
Lower Control Arm Bush



CH2019
Lower Control Arm



CH2117
Lower Control Arm Bush



CH2117
Lower Control Arm Bush



CH2812
Shock Mounting



CH2812
Shock Mounting



ORLANDO

REAR

CH2813
Shock Mounting



CH2813
Shock Mounting



LEFT

RIGHT

CHEVROLET

SONIC

FRONT

T300

Year

2011-

CH1012
Outer Tie Rod End
(Ø13.55*Ø16/M14*1.5)

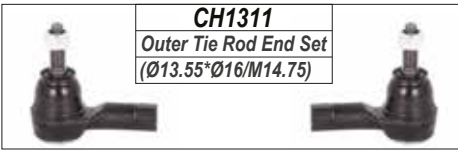

CH1311
Outer Tie Rod End Set
(Ø13.55*Ø16/M14.75)

CH1012
Outer Tie Rod End
(Ø13.55*Ø16/M14*1.5)



CH1411
Rack End
(16*1.5 /14*1.5/328)



OP1421
Rack End
(14*1.5/14*1.5/334)



CH1512
Link Stabilizer
L=295



CH1912
Lower Ball Joint
(Ø14.9)



CH2112
Lower Control Arm Bush



CH1912
Lower Ball Joint
(Ø14.9)



CH2012
Lower Control Arm



CH2013
Lower Control Arm



CH2113
Lower Control Arm Bush



CH2810
Shock Mounting



CH2810
Shock Mounting



LEFT

RIGHT

CHEVROLET

SPARK

FRONT

08 LS.LT.1.0 LS.LT

Year

2003-2009

CY1010
Outer Tie Rod End
(Ø12.6*Ø14.5/M12*1.5)

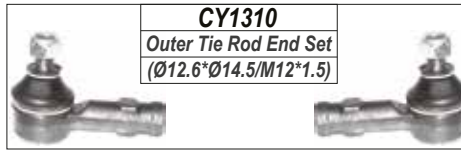

CY1310
Outer Tie Rod End Set
(Ø12.6*Ø14.5/M12*1.5)

CY1410
Rack End
(16*1.5 /12*1.5/250)

CY1011
Outer Tie Rod End
(Ø12.6*Ø14.5/M12*1.5)



CY2010
Lower Control Arm



CY2010
Lower Control Arm

CH2810
Shock Mounting



CH2810
Shock Mounting



LEFT

RIGHT

CHEVROLET

SPARK

FRONT

M300

Year

2010-

CH1017
Outer Tie Rod End
(Ø13.2*Ø15.1/M12*1.25)

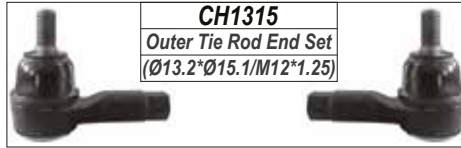

CH1315
Outer Tie Rod End Set
(Ø13.2*Ø15.1/M12*1.25)

CH1418
Rack End
(14*1.5 /12*1.25/245)

CH1017
Outer Tie Rod End
(Ø13.2*Ø15.1/M12*1.25)



CH1520
Link Stabilizer
L=235

CH1916
Lower Ball Joint
(Ø16)



CH2120
Lower Control Arm Bush

CH1916
Lower Ball Joint
(Ø16)



CH2022
Lower Control Arm



CH2023
Lower Control Arm



CH2121
Lower Control Arm Bush



CH2816
Shock Mounting



CH2816
Shock Mounting



LEFT

RIGHT

CHEVROLET

UTILITY

FRONT

ALL

Year

2012-

CH1018
Outer Tie Rod End
(Ø13.2*Ø15.1/M14*1.5)

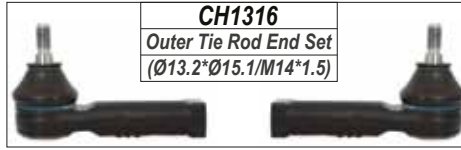

CH1316
Outer Tie Rod End Set
(Ø13.2*Ø15.1/M14*1.5)

CH1419
Rack End
(14*1.5 /14*1.5/274)

CH1018
Outer Tie Rod End
(Ø13.2*Ø15.1/M14*1.5)



CH1910
Lower Ball Joint
(Ø16)



CH2122
Lower Control Arm Bush



CH1910
Lower Ball Joint
(Ø16)



CH2024
Lower Control Arm



CH2025
Lower Control Arm



LEFT

RIGHT

CHRYSLER

300C

FRONT

ALL

Year

2004-

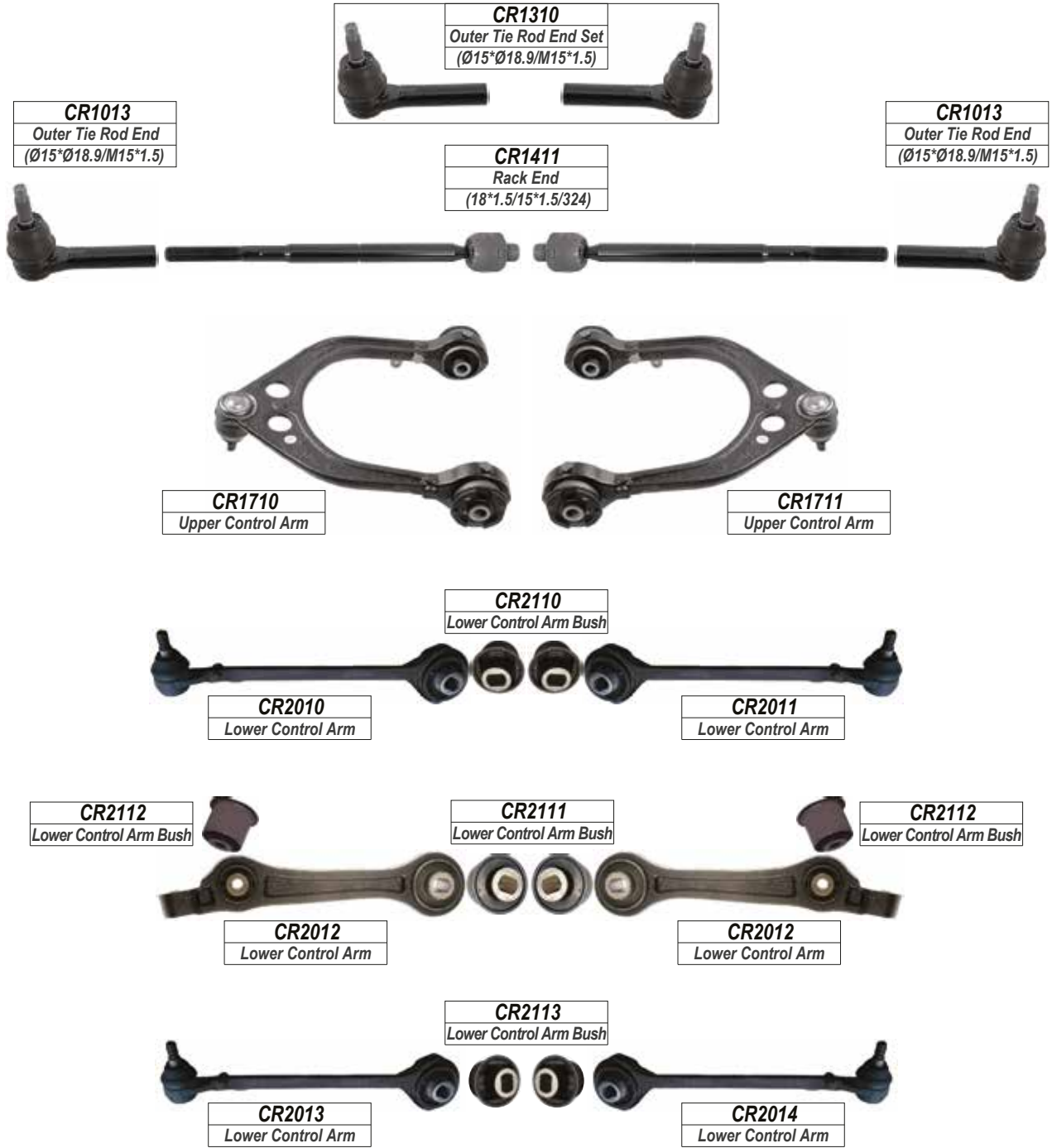

300C

REAR

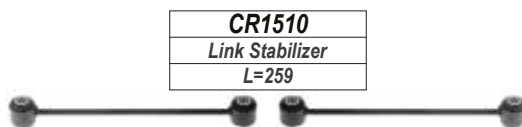

LEFT

RIGHT

CHRYSLER

**GRAND VOYAGER FRONT
VOYAGER**

Year

II (GS).2.0SE.2.4SE.2.5TD SE.

1997-2004

CR1010
Outer Tie Rod End
(Ø12.35*Ø15.1/M14*1.5)

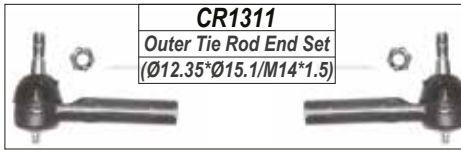

CR1410
Rack End
(14*1.5 /14*1.5/296)

CR1010
Outer Tie Rod End
(Ø12.35*Ø15.1/M14*1.5)



CR1511
Link Stabilizer
L=310



CR1910
Lower Ball Joint
(Ø18)



CR1910
Lower Ball Joint
(Ø18)

CR2015
Lower Control Arm

CR2016
Lower Control Arm

LEFT

RIGHT

CHRYSLER

**GRAND VOYAGER FRONT
VOYAGER**

Year

2001-2008

III

CR1011
Outer Tie Rod End
(Ø12.6*Ø16/M14*1.5)

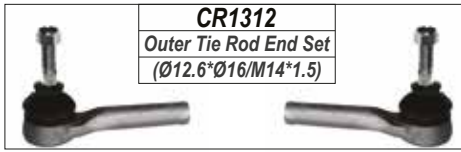

CR1312
Outer Tie Rod End Set
(Ø12.6*Ø16/M14*1.5)

CR1410
Rack End
(14*1.5 /14*1.5/296)

CR1011
Outer Tie Rod End
(Ø12.6*Ø16/M14*1.5)



CR1511
Link Stabilizer
L=310

CR1911
Lower Ball Joint
(Ø13.5)



CR2017
Lower Control Arm

CR2018
Lower Control Arm

CR1911
Lower Ball Joint
(Ø13.5)



LEFT

RIGHT

CHRYSLER

NEON.PT CRUISER FRONT

ALL

Year

1994-2006

CR1012
Outer Tie Rod End
(Ø12.4*Ø15.2/M14*1.5)

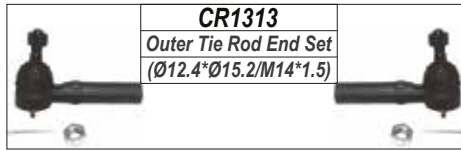

CR1313
Outer Tie Rod End Set
(Ø12.4*Ø15.2/M14*1.5)

CR1410
Rack End
(14*1.5 /14*1.5/296)

CR1012
Outer Tie Rod End
(Ø12.4*Ø15.2/M14*1.5)



CR2114
Lower Control Arm Bush



CR1910
Lower Ball Joint
(Ø18)



CR2019
Lower Control Arm

CR2020
Lower Control Arm

CR1910
Lower Ball Joint
(Ø18)



CR2115
Lower Control Arm Bush



CR2810
Shock Mounting



CR2810
Shock Mounting



NEON.PT CRUISER REAR

CR1512
Link Stabilizer
L=185.5



CR2811
Shock Mounting



CR2811
Shock Mounting



LEFT

RIGHT

CHRYSLER

SEBRING

FRONT

ALL

Year

2007-2010

CR1513
<i>Link Stabilizer</i>
<i>L=180.5</i>



LEFT

RIGHT

CITROEN

BERLINGO

FRONT

ALL MODELS

Year

1999-2010

CI1013
Outer Tie Rod End
(Ø12.1*Ø15.85/M14*1.5)

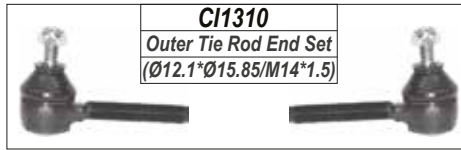

CI1410
Rack End
(12*1.0 / 14*1.5/262)

CI1013
Outer Tie Rod End
(Ø12.1*Ø15.85/M14*1.5)



CI1510
Link Stabilizer
L=300



CI1911
Lower Ball Joint
(Ø18)

CI2110
Lower Control Arm Bush

CI1911
Lower Ball Joint
(Ø18)

CI2010
Lower Control Arm

CI2011
Lower Control Arm



CI2111
Lower Control Arm Bush

CI2110
Lower Control Arm Bush

PE1920
Lower Ball Joint
(Ø16)

PE2042
Lower Control Arm

PE2043
Lower Control Arm

PE1920
Lower Ball Joint
(Ø16)



CI2810
Shock Mounting

CI2111
Lower Control Arm Bush

CI2810
Shock Mounting



LEFT

RIGHT

CITROEN

BERLINGO

FRONT

ALL MODELS

Year

2011-

CI1011
Outer Tie Rod End
(Ø12*Ø15/M14*1.5)



CI1311
Outer Tie Rod End Set
(Ø12*Ø15/M14*1.5)

CI1012
Outer Tie Rod End
(Ø12*Ø15/M14*1.5)



CI1411
Rack End
(14*1.5/14*1.5/255)



CI1511
Link Stabilizer
L=334



CI1912
Lower Ball Joint
(Ø18)



CI2112
Lower Control Arm Bush



CI1912
Lower Ball Joint
(Ø18)



CI2012
Lower Control Arm



CI2013
Lower Control Arm



CI2113
Lower Control Arm Bush



CI2811
Shock Mounting



CI2811
Shock Mounting



LEFT

RIGHT

CITROEN

C1

FRONT

ALL MODELS

Year

2006-

CI1013
Outer Tie Rod End
(Ø12.5*Ø15/M12*1.25)



CI1312
Outer Tie Rod End Set
(Ø12.5*Ø15/M12*1.25)

CI1014
Outer Tie Rod End
(Ø12.5*Ø15/M12*1.25)



CI1412
Rack End
(14*1.5/12*1.25/222)



CI1512
Link Stabilizer
L=92



CI2114
Lower Control Arm Bush



CI1913
Lower Ball Joint
(Ø13.5)



CI1913
Lower Ball Joint
(Ø13.5)



CI2014
Lower Control Arm



CI2015
Lower Control Arm

CI2115
Lower Control Arm Bush



CI2812
Shock Mounting



CI2812
Shock Mounting



LEFT

RIGHT

CITROEN

C2

FRONT

ALL MODELS

Year

2003-2010

CI1015
Outer Tie Rod End
(Ø12.1*Ø15.1/M14*1.5)

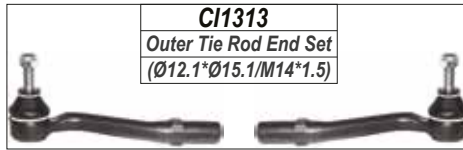

CI1313
Outer Tie Rod End Set
(Ø12.1*Ø15.1/M14*1.5)

CI1413
Rack End
(12*1.0/14*1.5/239)



CI1016
Outer Tie Rod End
(Ø12.1*Ø15.1/M14*1.5)



CI1513
Link Stabilizer
L=335



CI2116
Lower Control Arm Bush



CI1914
Lower Ball Joint
(Ø18)



CI2016
Lower Control Arm

CI2017
Lower Control Arm

CI1914
Lower Ball Joint
(Ø18)



CI2117
Lower Control Arm Bush



CI2813
Shock Mounting(Pin Mid)



CI2813
Shock Mounting(Pin Mid)



CI2814
Shock Mounting



CI2814
Shock Mounting



LEFT

RIGHT

CITROEN

C3

FRONT

ALL MODELS

Year

2003-2011

CI1015
Outer Tie Rod End
(Ø12.1*Ø15.1/M14*1.5)

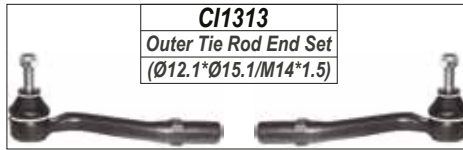

CI1313
Outer Tie Rod End Set
(Ø12.1*Ø15.1/M14*1.5)

CI1016
Outer Tie Rod End
(Ø12.1*Ø15.1/M14*1.5)



CI1413
Rack End
(12*1.0/14*1.5/245)



CI1513
Link Stabilizer
L=335



CI2116
Lower Control Arm Bush



CI1914
Lower Ball Joint
(Ø18)



CI1914
Lower Ball Joint
(Ø18)



CI2016
Lower Control Arm



CI2017
Lower Control Arm

CI2117
Lower Control Arm Bush



CI2813
Shock Mounting(Pin Mid)



CI2813
Shock Mounting(Pin Mid)



CI2815
Shock Mounting



CI2815
Shock Mounting



LEFT

RIGHT

CITROEN

C3

FRONT

ALL MODELS

Year

2010-

CI1017
Outer Tie Rod End
(Ø12.26*Ø15.2/M14*1.5)



CI1314
Outer Tie Rod End Set
(Ø12.26*Ø15.2/M14*1.5)

CI1018
Outer Tie Rod End
(Ø12.26*Ø15.2/M14*1.5)



CI1414
Rack End
(12*1.0/14*1.5/245)

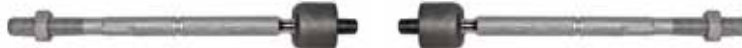

CI1513
Link Stabilizer
L=335



CI1514
Link Stabilizer
L=335



CI2118
Lower Control Arm Bush

CI1915
Lower Ball Joint
(Ø18)



CI2018
Lower Control Arm



CI2019
Lower Control Arm



CI1915
Lower Ball Joint
(Ø18)

CI2119
Lower Control Arm Bush



CI2815
Shock Mounting



CI2815
Shock Mounting



LEFT

RIGHT

CITROEN

C4

FRONT

ALL MODELS

Year

2004-2010

CI1019
Outer Tie Rod End
(Ø12.1*Ø15.85/M14*1.5)



CI1315
Outer Tie Rod End Set
(Ø12.1*Ø15.85/M14*1.5)

CI1415
Rack End
(14*1.5/14*1.5/319)

CI1020
Outer Tie Rod End
(Ø12.1*Ø15.85/M14*1.5)



CI1010
Outer Tie Rod End
(Ø12.1*Ø15.85/M14*1.5)



CI1010
Outer Tie Rod End
(Ø12.1*Ø15.85/M14*1.5)



CI1515
Link Stabilizer
L=335



CI2112
Lower Control Arm Bush



CI1912
Lower Ball Joint
(Ø15.7)



CI2012
Lower Control Arm

CI2013
Lower Control Arm

CI1912
Lower Ball Joint
(Ø15.7)



CI2811
Shock Mounting



CI2811
Shock Mounting



CI2113
Lower Control Arm Bush



CI2816
Shock Mounting



CI2816
Shock Mounting



LEFT

RIGHT

CITROEN

C4

FRONT

ALL MODELS

Year

2010-

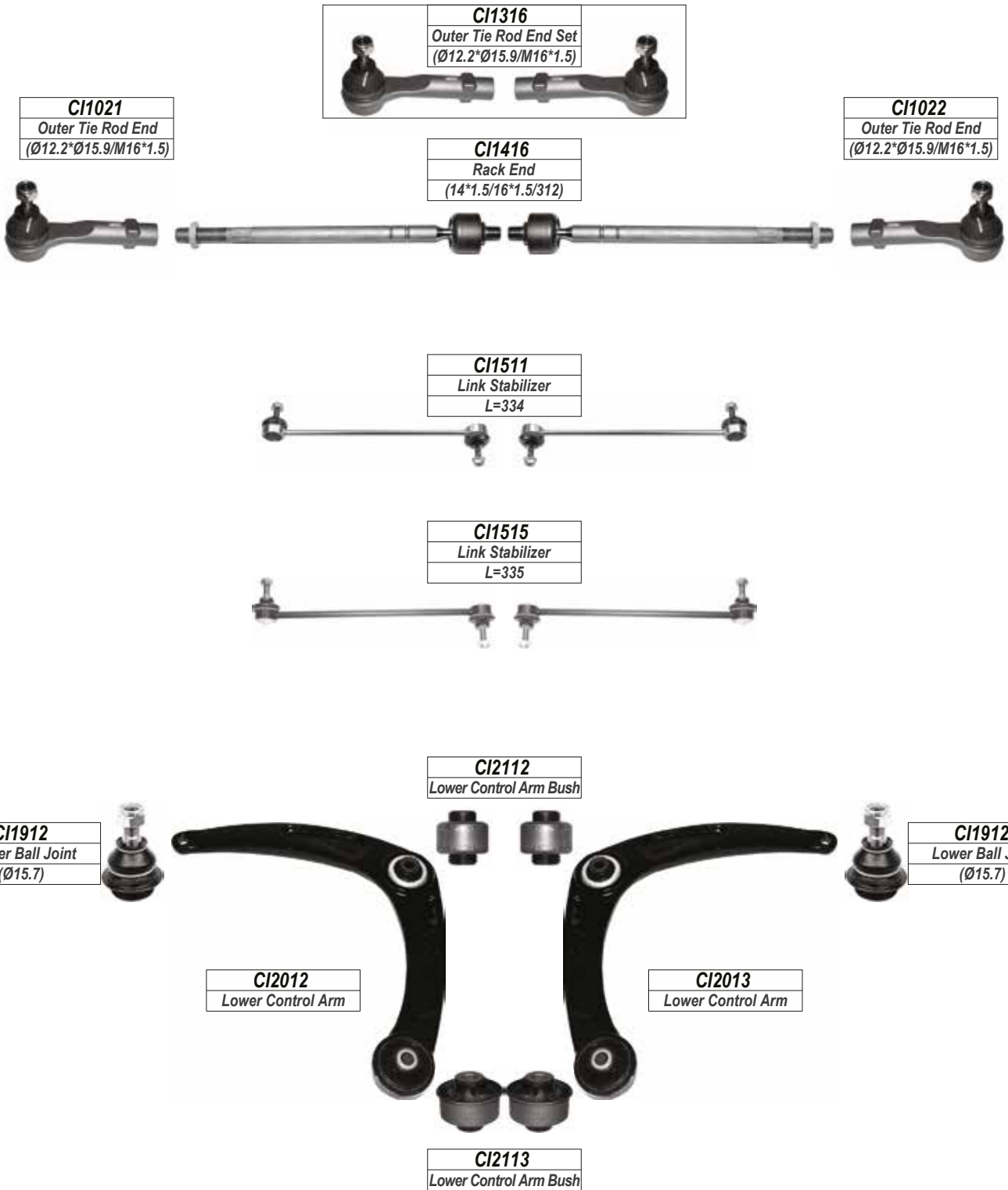

LEFT

RIGHT

CITROEN

C4 AIRCROSS

FRONT

ALL MODELS

Year

2012-

CI1029
Outer Tie Rod End
(Ø13.45*Ø15.1/M14*1.5)

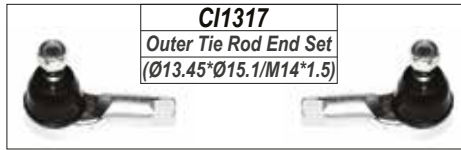

CI1420
Rack End
(14*1.5/14*1.5/341)

CI1029
Outer Tie Rod End
(Ø13.45*Ø15.1/M14*1.5)



CI1516
Link Stabilizer
L=265



CI2121
Lower Control Arm Bush

CI1910
Lower Ball Joint
(Ø20)



CI1910
Lower Ball Joint
(Ø20)

CI2020
Lower Control Arm

CI2021
Lower Control Arm

CI2120
Lower Control Arm Bush



C4 AIRCROSS

REAR

DO1511 / DO1512
Link Stabilizer
L=80



LEFT

RIGHT

CITROEN

C4

FRONT

PICASSO II

Year

2013-

CI1030
Outer Tie Rod End
(Ø14.4*Ø19/M14*1.5)



CI1318
Outer Tie Rod End Set
(Ø14.4*Ø19/M14*1.5)

CI1421
Rack End
(14*1.5/14*1.5/220)



CI1031
Outer Tie Rod End
(Ø14.4*Ø19/M14*1.5)



CI2022
Lower Control Arm

CI2023
Lower Control Arm

LEFT

RIGHT

CITROEN

C5

FRONT

DC.DE.RC.RE

Year

2001-2008

CI1023
Outer Tie Rod End
(Ø11.9*Ø15.7/M16*1.5)



CI1319
Outer Tie Rod End Set
(Ø11.9*Ø15.7/M16*1.5)

CI1417
Rack End
(16*1.5/16*1.5/182)



CI1024
Outer Tie Rod End
(Ø11.9*Ø15.7/M16*1.5)



CI1517
Link Stabilizer
L=320



CI1916
Lower Ball Joint
(Ø15.8)



CI2122
Lower Control Arm Bush



CI2024
Lower Control Arm



CI2025
Lower Control Arm



CI1916
Lower Ball Joint
(Ø15.8)

CI2123
Lower Control Arm Bush



LEFT

RIGHT

CITROEN

C5

FRONT

RD.TD

Year

2008-

CI1025
Outer Tie Rod End
(Ø14.8*Ø17.9/M14*1.5)



CI1320
Outer Tie Rod End Set
(Ø14.8*Ø17.9/M14*1.5)

CI1026
Outer Tie Rod End
(Ø14.8*Ø17.9/M14*1.5)



CI1418
Rack End
(16*1.5/14*1.5/129)



CI1518 / CI1519
Link Stabilizer
L=200

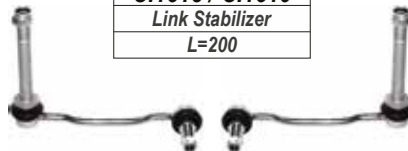

CI1610
Upper Ball Joint
(Ø18)



CI1610
Upper Ball Joint
(Ø18)



CI2124
Lower Control Arm Bush



CI2026
Lower Control Arm

CI2027
Lower Control Arm

CI1917
Lower Ball Joint



CI1917
Lower Ball Joint



CI2125
Lower Control Arm Bush



C5

REAR

CI1520
Link Stabilizer
L=141



LEFT

RIGHT

CITROEN

DS3

FRONT

ALL MODELS

Year

2010-2015

CI1017
Outer Tie Rod End
(Ø12.26*Ø15.2/M14*1.5)



CI1314
Outer Tie Rod End Set
(Ø12.26*Ø15.2/M14*1.5)

CI1414
Rack End
(12*1.0/14*1.5/245)



CI1018
Outer Tie Rod End
(Ø12.26*Ø15.2/M14*1.5)



CI1513
Link Stabilizer
L=335



CI1514
Link Stabilizer
L=335



CI2118
Lower Control Arm Bush



CI1915
Lower Ball Joint
(Ø18)



CI1915
Lower Ball Joint
(Ø18)



CI2018
Lower Control Arm



CI2019
Lower Control Arm



CI2119
Lower Control Arm Bush



LEFT

RIGHT

CITROEN

RELAY

FRONT

ALL MODELS

Year

2012-

CI1027
Outer Tie Rod End
(Ø16.65*Ø21.4/M16*1.5)



CI1419
Rack End
(16*1.5/16*1.5/260)

CI1028
Outer Tie Rod End
(Ø16.65*Ø21.4/M16*1.5)



CI1521
Link Stabilizer
L=112



CI2126
Lower Control Arm Bush

CI1918
Lower Ball Joint
(Ø20.55)



CI2028
Lower Control Arm



CI2029
Lower Control Arm

CI1918
Lower Ball Joint
(Ø20.55)

CI2127
Lower Control Arm Bush

RELAY

REAR

CI1522
Link Stabilizer
L=100



LEFT

RIGHT

CITROEN

XSARA PICASSO FRONT

N68

Year

2001-

CI1010
Outer Tie Rod End
(Ø12.1*Ø15.85/M14*1.5)

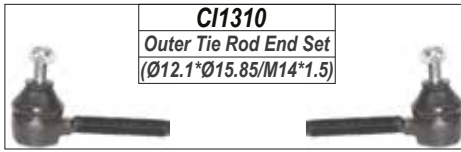

CI1310
Outer Tie Rod End Set
(Ø12.1*Ø15.85/M14*1.5)

CI1010
Outer Tie Rod End
(Ø12.1*Ø15.85/M14*1.5)

CI1410
Rack End
(12*1.0/14*1.5/335)



CI1422
Rack End
(12*1.0/14*1.5/338)



CI1510
Link Stabilizer
L=300



CI1911
Lower Ball Joint
(Ø18)

CI2110
Lower Control Arm Bush

CI1911
Lower Ball Joint
(Ø18)



CI2010
Lower Control Arm

CI2011
Lower Control Arm



CI2111
Lower Control Arm Bush

CI2110
Lower Control Arm Bush



CI2810
Shock Mounting

CI2030
Lower Control Arm

CI2031
Lower Control Arm

CI2810
Shock Mounting



CI2111
Lower Control Arm Bush

CI2910
Axle Beam



RELAY

REAR

LEFT

RIGHT

CMC

SESBUYILE

FRONT

2.4 4RB2

Year

2011-

CM1010
Outer Tie Rod End
(Ø12.6*Ø14.5/M12*1.5)

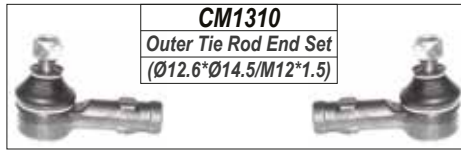

CM1310
Outer Tie Rod End Set
(Ø12.6*Ø14.5/M12*1.5)

CA1411
Rack End
(14*1.5/15*1.5/274)



CM1010
Outer Tie Rod End
(Ø12.6*Ø14.5/M12*1.5)



CM1510
Link Stabilizer
L=159.5



CM1710
Upper Control Arm

CM1711
Upper Control Arm

CM1910
Lower Ball Joint
(Ø17.25)



CM2010
Lower Control Arm



CM2011
Lower Control Arm

CM1910
Lower Ball Joint
(Ø17.25)



LEFT

RIGHT

DAEWOO

CIELO.ESPERO.LANOS FRONT

Year

ALL MODELS

1996-2004

DA1010
Outer Tie Rod End
(Ø13*Ø15.3/M16*1.5)

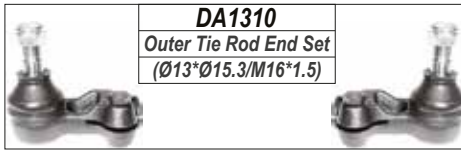

DA1310
Outer Tie Rod End Set
(Ø13*Ø15.3/M16*1.5)

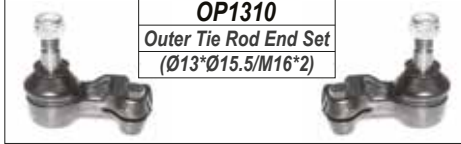

OP1310
Outer Tie Rod End Set
(Ø13*Ø15.5/M16*2)

DA1011
Outer Tie Rod End
(Ø13*Ø15.3/M16*1.5)



OP1016
Outer Tie Rod End
(Ø13*Ø15.5/M16*2)



DA2210
Rack End



OP1017
Outer Tie Rod End
(Ø13*Ø15.5/M16*2)



DA2210 / DA2211
Center Rod



DA1510
Link Stabilizer
L=197.5

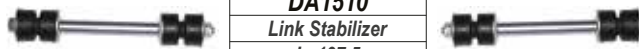

DA2111
Lower Control Arm Bush

DA1914
Lower Ball Joint
(Ø13.3)



DA1914
Lower Ball Joint
(Ø13.3)

DA2010
Lower Control Arm

DA2011
Lower Control Arm

DA2811
Shock Mounting



DA2811
Shock Mounting



DA2810
Shock Mounting



DA2810
Shock Mounting



DA2110
Lower Control Arm Bush



CIELO.ESPERO.LANOS REAR

DA2910
Bush



LEFT

RIGHT

DAEWOO

LEGANZA

FRONT

ALL MODELS

Year

2001-2004

DA1012
Outer Tie Rod End
(Ø13.3*Ø15.35/M14*1.5)



DA1311
Outer Tie Rod End Set
(Ø13.3*Ø15.35/M14*1.5)



DA1411
Rack End
(16*1.5/14*1.5/374.1)



DA1012
Outer Tie Rod End
(Ø13.3*Ø15.35/M14*1.5)



DA1511 / DA1512
Link Stabilizer
L=80



DA1915
Lower Ball Joint
(Ø18)



DA1915
Lower Ball Joint
(Ø18)



LEFT

RIGHT

DAEWOO

MATIZ

FRONT

ALL MODELS

Year

1999-2004

CY1010
Outer Tie Rod End
(Ø12.6*Ø14.5/M12*1.5)

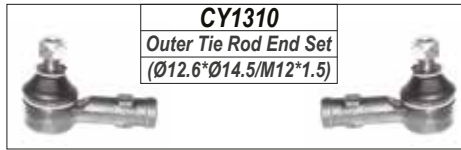

CY1310
Outer Tie Rod End Set
(Ø12.6*Ø14.5/M12*1.5)

DA1410
Rack End
(16*1.5 /12*1.5/250)



CY1010
Outer Tie Rod End
(Ø12.6*Ø14.5/M12*1.5)



CY2010
Lower Control Arm



CY2010
Lower Control Arm

LEFT

RIGHT

DAEWOO

NUBIRA

FRONT

Year

NUBIRA 1. NUBIRA 2

1997-2004

DA1012
Outer Tie Rod End
(Ø13.3*Ø15.3/M14*1.5)

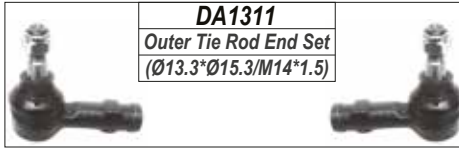

DA1311
Outer Tie Rod End Set
(Ø13.3*Ø15.3/M14*1.5)

CH1416
Rack End
(16*1.5/14*1.5/345)



DA1012
Outer Tie Rod End
(Ø13.3*Ø15.3/M14*1.5)



DA1513
Link Stabilizer
L=266



CH1510
Link Stabilizer
L=261



DA1916
Lower Ball Joint
(Ø16)



DA2012
Lower Control Arm

DA2013
Lower Control Arm

DA1916
Lower Ball Joint
(Ø16)



DA2812
Shock Mounting



DA2812
Shock Mounting



NUBIRA

REAR

CH1511
Link Stabilizer
L=247



LEFT

RIGHT

DAEWOO

TACUMA

FRONT

ALL MODELS

Year

2001-

DA1013
Outer Tie Rod End
(Ø13.3*Ø15.1/M14*1.5)

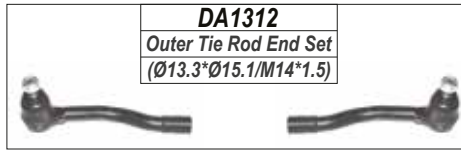

DA1014
Outer Tie Rod End
(Ø13.3*Ø15.1/M14*1.5)



DA1410
Rack End
(16*1.5 / 14*1.5/240)



CH1510
Link Stabilizer
L=261



DA1917
Lower Ball Joint
(Ø16)



DA1917
Lower Ball Joint
(Ø16)



CH2118
Bush



TACUMA

REAR

CH1511
Link Stabilizer
L=247



LEFT

RIGHT

DAIHATSU

CHARADE

FRONT

G11

Year

1983-1985

DH1010
Outer Tie Rod End
(Ø11.76*Ø14.1/M12*1.25)



DH1310
Outer Tie Rod End Set
(Ø11.76*Ø14.1/M12*1.25)

DH1410
Rack End
(11*1.5 /12*1.25/224)



DH1011
Outer Tie Rod End
(Ø11.76*Ø14.1/M12*1.25)



DH2010
Lower Control Arm



DH2010
Lower Control Arm



DH2011
Lower Control Arm
Import Only



DH2012
Lower Control Arm
Import Only

LEFT

RIGHT

DAIHATSU

CHARADE

FRONT

ALL MODELS

Year

2003-

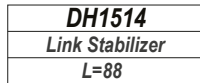
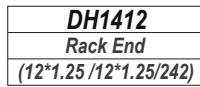
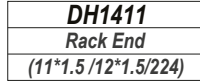
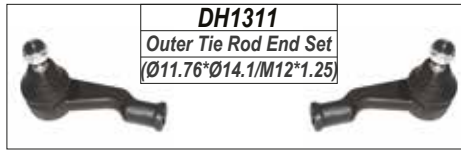

LEFT

RIGHT

DAIHATSU

CUORE/MOVE

FRONT

847

Year

1997-

DH1012
Outer Tie Rod End
(Ø11.76*Ø14.1/M12*1.25)



DH1311
Outer Tie Rod End Set
(Ø11.76*Ø14.1/M12*1.25)

DH1013
Outer Tie Rod End
(Ø11.76*Ø14.1/M12*1.25)



DH1411
Rack End
(11*1.5 /12*1.5/224)



DH2013
Lower Control Arm



DH2014
Lower Control Arm

CUORE/MOVE

REAR

DH1510
Link Stabilizer
L=55.5



LEFT

RIGHT

DAIHATSU

SIRION

FRONT

Year

1998-2003



<p>DH1411 Rack End (11*1.5 / 12*1.25/224)</p>
--

<p>DH1014 Outer Tie Rod End (Ø12*Ø14/M12*1.25)</p>



<p>DH1015 Outer Tie Rod End (Ø12*Ø14/M12*1.25)</p>



<p>DH1412 Rack End (12*1.25 / 12*1.25/242)</p>



<p>DH2013 Lower Control Arm</p>
--



<p>DH2014 Lower Control Arm</p>
--

LEFT

RIGHT

DAIHATSU

SIRION

FRONT

II

Year

2003-2009

DH1010
Outer Tie Rod End
(Ø11.76*Ø14.1/M12*1.25)



DH1310
Outer Tie Rod End Set
(Ø11.76*Ø14.1/M12*1.25)

DH1410
Rack End
(11*1.5 / 12*1.25/244)



DH1011
Outer Tie Rod End
(Ø11.76*Ø14.1/M12*1.25)



DH1413
Rack End
(14*1.5/14*1.5/257)



DH1315
Outer Tie Rod End Set
(Ø11.76*Ø14.1/M14*1.5)
- 05

DH1019
Outer Tie Rod End
(Ø11.76*Ø14.1/M14*1.5)
- 05



DH1415
Rack End
(14*1.5 / 14*1.5/243)
- 05



DH1020
Outer Tie Rod End
(Ø11.76*Ø14.1/M14*1.5)
- 05

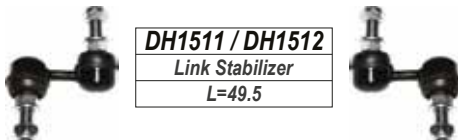

DH1511 / DH1512
Link Stabilizer
L=49.5



DH2015
Lower Control Arm

DH2016
Lower Control Arm

DH2113
Lower Control Arm Bush

DH2112
Lower Control Arm Bush

LEFT

RIGHT

DAIHATSU

TERIOS

FRONT

Year

1997-2005

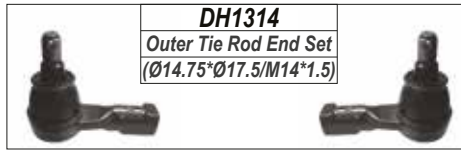

DH1016
Outer Tie Rod End
(Ø14.75*Ø17.5/M14*1.5)

DH1016
Outer Tie Rod End
(Ø14.75*Ø17.5/M14*1.5)

DH1410
Rack End
(14*1.5 /14*1.5/295)



DH1513
Link Stabilizer
L=114.5



DH2017
Lower Control Arm



DH2018
Lower Control Arm

LEFT

RIGHT

DAIHATSU

TERIOS

FRONT

II

Year

2005-

DH1017
Outer Tie Rod End
(Ø14.75*Ø17.5/M14*1.5)

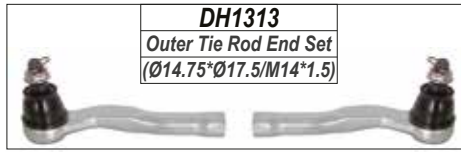

DH1313
Outer Tie Rod End Set
(Ø14.75*Ø17.5/M14*1.5)

DH1018
Outer Tie Rod End
(Ø14.75*Ø17.5/M14*1.5)



DH1414
Rack End
(14*1.5 /14*1.5/295)



DH1513
Link Stabilizer
L=114.5



DH2111
Lower Control Arm Bush



DH1910
Lower Ball Joint
(Ø18.1)



DH2019
Lower Control Arm

DH2020
Lower Control Arm

DH1910
Lower Ball Joint
(Ø18.1)



DH2110
Lower Control Arm Bush



LEFT

RIGHT

DATSUN

GO

FRONT

ALL MODELS

Year

2015-

DT1010
Outer Tie Rod End
(Ø11.7*Ø14.6/M12*1.25)



DT1310
Outer Tie Rod End Set
(Ø11.7*Ø14.6/M12*1.25)

DT1410
Rack End
(14*1.5/12*1.25/228)



DT1011
Outer Tie Rod End
(Ø11.7*Ø14.6/M12*1.25)



DT2110
Lower Control Arm Bush



DT1910
Lower Ball Joint
(Ø16)



DT2010
Lower Control Arm

DT2011
Lower Control Arm

DT1910
Lower Ball Joint
(Ø16)



DT2111
Lower Control Arm Bush



DT2810
Shock Mounting



LEFT

RIGHT

DODGE

CALIBER

FRONT

ALL MODELS

Year

2006-

CR1011
Outer Tie Rod End
(Ø12.6*Ø16/M14*1.5)



CR1312
Outer Tie Rod End Set
(Ø12.6*Ø16/M14*1.5)

CR1011
Outer Tie Rod End
(Ø12.6*Ø16/M14*1.5)

DO1410
Rack End
(14*1.5 /14*1.5/298)



DO1510
Link Stabilizer
L=266



CR1513
Link Stabilizer
L=180.5



JE2111
Lower Control Arm Bush

DO1911
Lower Ball Joint
(Ø20)



JE2012
Lower Control Arm

JE2013
Lower Control Arm

DO1911
Lower Ball Joint
(Ø20)



JE2110
Lower Control Arm Bush



DO2810
Shock Mounting



DO2810
Shock Mounting



CALIBER

REAR

DO1511 / DO1512
Link Stabilizer
L=80



LEFT

RIGHT

DODGE

JOURNEY

FRONT

Year

ALL MODELS

2008-

CR1011
Outer Tie Rod End
(Ø12.6*Ø16/M14*1.5)

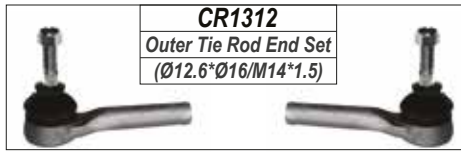

CR1312
Outer Tie Rod End Set
(Ø12.6*Ø16/M14*1.5)

DO1410
Rack End
(14*1.5 /14*1.5/298)



CR1011
Outer Tie Rod End
(Ø12.6*Ø16/M14*1.5)



DO1510
Link Stabilizer
L=266



DO2111
Lower Control Arm Bush



DO1910
Lower Ball Joint
(Ø15.8)



DO2010
Lower Control Arm

DO2011
Lower Control Arm

DO1910
Lower Ball Joint
(Ø15.8)



DO2811
Shock Mounting



DO2110
Lower Control Arm Bush



DO2811
Shock Mounting



JOURNEY

REAR

DO1511 / DO1512
Link Stabilizer
L=80



DO2610
Lateral Link(Upper)



DO2611
Lateral Link(Lower)



LEFT

RIGHT

DODGE

NITRO

FRONT

ALL MODELS

Year

2007-

DO1010
Outer Tie Rod End
(Ø15*Ø18.9/M16*1.5)



DO1310
Outer Tie Rod End Set
(Ø15*Ø18.9/M16*1.5)

DO1011
Outer Tie Rod End
(Ø15*Ø18.9/M16*1.5)



DO1411
Rack End
(18*1.5 / 16*1.5/285)



CR1513
Link Stabilizer
L=180.5



CR1514
Link Stabilizer
L=270



DO1912
Lower Ball Joint
(Ø17.3)



DO2012
Lower Control Arm

DO2013
Lower Control Arm

DO1912
Lower Ball Joint
(Ø17.3)

LEFT

RIGHT

FIAT

500

FRONT

C

Year

2007-

FI1010
Outer Tie Rod End
(Ø11.3*Ø13.71/M12*1.5)

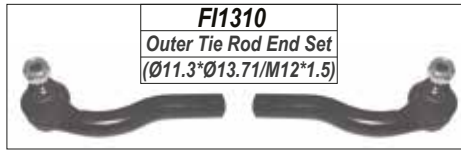

FI1310
Outer Tie Rod End Set
(Ø11.3*Ø13.71/M12*1.5)

FI1410
Rack End
(14*1.5/12*1.5/255)

FI1011
Outer Tie Rod End
(Ø11.3*Ø13.71/M12*1.5)



FI1510
Link Stabilizer
L=287



FI2110
Lower Control Arm Bush



FI2010
Lower Control Arm

FI2011
Lower Control Arm

FI2111
Lower Control Arm Bush

FI2810
Shock Mounting



FI2810
Shock Mounting



LEFT

RIGHT

FIAT

500L

FRONT

ALL MODELS

Year

2008-2015



LEFT

RIGHT

FIAT

500X

FRONT

ALL MODELS

Year

2015-

FI1012
Outer Tie Rod End
(Ø11.7*Ø14.8/M14*1.5)

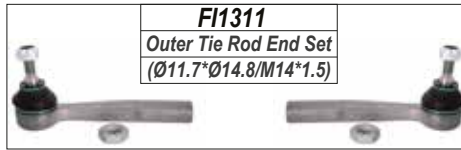

AF1418
Rack End
(14*1.5 /14*1.5/295)

FI1013
Outer Tie Rod End
(Ø11.7*Ø14.8/M14*1.5)



FI1511
Link Stabilizer
L=287



FI1911
Lower Ball Joint
(Ø18.9)



FI2114
Lower Control Arm Bush

FI1911
Lower Ball Joint
(Ø18.9)



FI2014
Lower Control Arm



FI2015
Lower Control Arm

FI2115
Lower Control Arm Bush



LEFT

RIGHT

FIAT

BRAVO I / II

FRONT

Year

ALL MODELS

2006-

FI1014
Outer Tie Rod End
(Ø11.72*Ø14.8/M14*1.5)

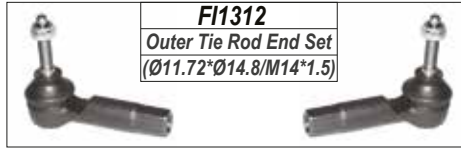

FI1312
Outer Tie Rod End Set
(Ø11.72*Ø14.8/M14*1.5)

FI1411
Rack End
(14*1.5 / 14*1.5 / 311)

FI1014
Outer Tie Rod End
(Ø11.72*Ø14.8/M14*1.5)



FI1912
Lower Ball Joint
(Ø17)



FI2116
Lower Control Arm Bush

FI1912
Lower Ball Joint
(Ø17)



FI2016
Lower Control Arm

FI2017
Lower Control Arm

FI2117
Lower Control Arm Bush

FI2116
Lower Control Arm Bush



FI2018
Lower Control Arm
Sheet Metal (1.9 Mjet)

FI2019
Lower Control Arm
Sheet Metal (1.9 Mjet)

FI2117
Lower Control Arm Bush

LEFT

RIGHT

FIAT

DOBLO

FRONT

ALL MODELS

Year

2000-

FI1012
Outer Tie Rod End
(Ø11.7*Ø14.8/M14*1.5)

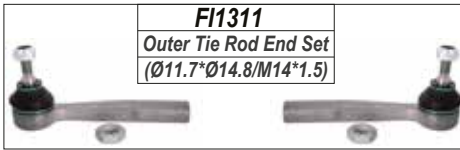

FI1412
Rack End
(16*1.5 /14*1.5/328)

FI1012
Outer Tie Rod End
(Ø11.7*Ø14.8/M14*1.5)



FI1413
Rack End
(16*1.5 /14*1.5/292)

FI1016
Outer Tie Rod End
(Ø12*Ø13.6/M14*1.5)



FI1512
Link Stabilizer
L=132

FI1913
Lower Ball Joint
(Ø13.6)

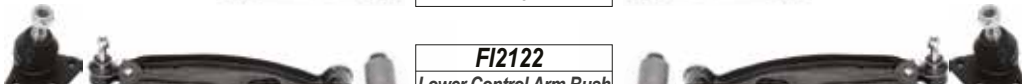

FI2122
Lower Control Arm Bush

FI1913
Lower Ball Joint
(Ø13.6)

FI2020
Lower Control Arm

FI2021
Lower Control Arm



FI2120 / FI2121
Lower Control Arm Bush

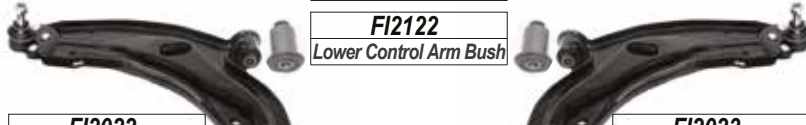

FI2122
Lower Control Arm Bush

FI2022
Lower Control Arm

FI2023
Lower Control Arm



FI2120 / FI2121
Lower Control Arm Bush

FI2815
Shock Mounting



FI2024
Lower Control Arm

FI2122
Lower Control Arm Bush

FI2025
Lower Control Arm

FI2816
Shock Mounting



FI2118 / FI2119
Lower Control Arm Bush

LEFT

RIGHT

FIAT

DOBLO

FRONT

ALL MODELS

Year

2010-

FI1017
Outer Tie Rod End
(Ø11.75*Ø14.1/M14*1.5)



FI1414
Rack End
(18*1.5 / 14*1.5/299)

FI1018
Outer Tie Rod End
(Ø11.75*Ø14.1/M14*1.5)

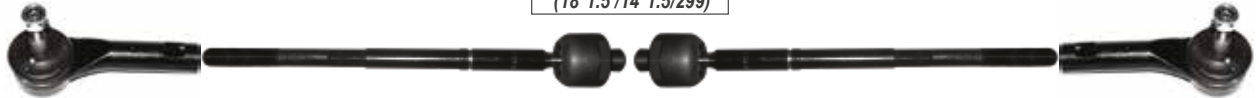

FI1513
Link Stabilizer
L=297



FI1910
Lower Ball Joint
(Ø18)



FI2026
Lower Control Arm



FI2027
Lower Control Arm



FI1910
Lower Ball Joint
(Ø18)

AF2124
Lower Control Arm Bush



LEFT

RIGHT

FIAT

DUCATO

FRONT

14Q.18Q

Year

2002-2006

FI1019
Outer Tie Rod End
(Ø16.65*Ø21.35/M16*1.5)

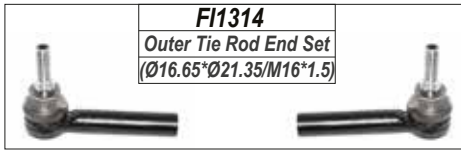

FI1415
Rack End
(16*1.5/16*1.5/317)

FI1019
Outer Tie Rod End
(Ø16.65*Ø21.35/M16*1.5)



FI1514
Link Stabilizer
L=134



FI2123
Lower Control Arm Bush

FI1914
Lower Ball Joint(14Q)
(Ø16.65)



FI1914
Lower Ball Joint(14Q)
(Ø16.65)

FI2028
Lower Control Arm(14Q)

FI2029
Lower Control Arm(14Q)

FI2124
Lower Control Arm Bush

FI1915
Lower Ball Joint(18Q)
(Ø19.8)



FI1915
Lower Ball Joint(18Q)
(Ø19.8)

FI2030
Lower Control Arm(18Q)

FI2031
Lower Control Arm(18Q)

FI2123
Lower Control Arm Bush

FI2124
Lower Control Arm Bush

LEFT

RIGHT

FIAT

DUCATO

FRONT

15Q.17Q.17H.20Q

Year

2006-

CI1027
Outer Tie Rod End
(Ø16.65*Ø21.4/M16*1.5)

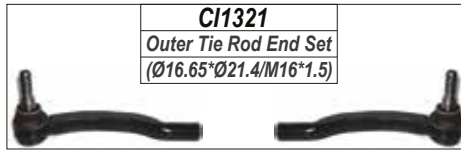

CI1321
Outer Tie Rod End Set
(Ø16.65*Ø21.4/M16*1.5)

CI1419
Rack End
(16*1.5/16*1.5/260)

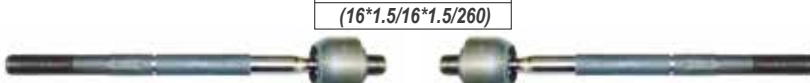

CI1028
Outer Tie Rod End
(Ø16.65*Ø21.4/M16*1.5)



CI1521
Link Stabilizer
L=112



CI2126
Lower Control Arm Bush



CI1918
Lower Ball Joint
(Ø20.55)



CI2028
Lower Control Arm

CI2029
Lower Control Arm

CI1918
Lower Ball Joint
(Ø20.55)

CI2127
Lower Control Arm Bush



DUCATO

REAR

CI1522
Link Stabilizer
L=100



LEFT

RIGHT

FIAT

FIORINO-LINEA-QUBO FRONT

ALL MODELS

Year

2008-

AF1026
Outer Tie Rod End
(Ø11.8*Ø14.8/M14*1.5)

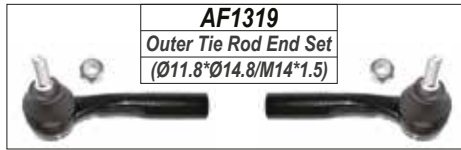

AF1319
Outer Tie Rod End Set
(Ø11.8*Ø14.8/M14*1.5)

F11416
Rack End
(14*1.5 / 14*1.5/267)

AF1027
Outer Tie Rod End
(Ø11.8*Ø14.8/M14*1.5)



F11515
Link Stabilizer
L=290



AF2122
Lower Control Arm Bush



AF1913
Lower Ball Joint
(Ø20.55)



AF1913
Lower Ball Joint
(Ø20.55)



AF2026
Lower Control Arm



AF2027
Lower Control Arm

AF2124
Lower Control Arm Bush



F12817
Shock Mounting



F12818
Shock Mounting



LEFT

RIGHT

FIAT

FULLBACK

FRONT

502 / 503

Year

2016-

MI1320

Outer Tie Rod End Set
(Ø13.65*Ø15.9/M16*1.5)

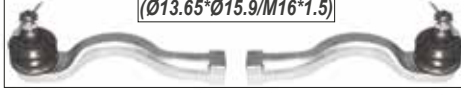

MI1015

Outer Tie Rod End
(Ø13.65*Ø15.9/M16*1.5)



FI1426

Rack End
(16*1.5/16*1.5/218)



MI1016

Outer Tie Rod End
(Ø13.5*Ø15/M12*1.25)



FI1525 / FI1526

Link Stabilizer
L=80



FI1610

Upper Ball Joint
(Ø16)



FI1610

Upper Ball Joint
(Ø16)



FI2138

Upper Control Arm Bush



FI1710

Upper Control Arm



FI1711

Upper Control Arm



MI1913

Lower Ball Joint
(Ø19.5)



MI1913

Lower Ball Joint
(Ø19.5)



FI2139

Lower Control Arm Bush



FI2054

Lower Control Arm



FI2055

Lower Control Arm



LEFT

RIGHT

FIAT

MULTIPLA

FRONT

ALL MODELS

Year

1999-2007

AF1012
Outer Tie Rod End
(Ø12*Ø13.5/M14*1.5)

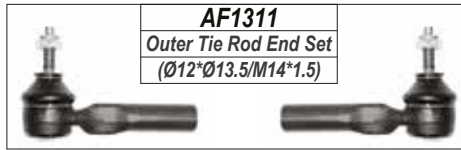

AF1311
Outer Tie Rod End Set
(Ø12*Ø13.5/M14*1.5)

AF1012
Outer Tie Rod End
(Ø12*Ø13.5/M14*1.5)



F11417
Rack End
(14*1.5/14*1.5/301)



F11516
Link Stabilizer
L=274.5



FI2125 / FI2126
Lower Control Arm Bush



FI2032
Lower Control Arm

FI2033
Lower Control Arm

AF2115 / AF2116
Lower Control Arm Bush

LEFT

RIGHT

FIAT

PALIO / SIENA

FRONT

ALL MODELS

Year

1999-2006

FI1015
Outer Tie Rod End
(Ø12*Ø13.6/M14*1.5)

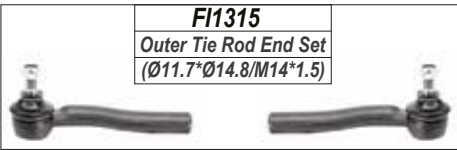

FI1315
Outer Tie Rod End Set
(Ø11.7*Ø14.8/M14*1.5)

FI1016
Outer Tie Rod End
(Ø12*Ø13.6/M14*1.5)



FI1418
Rack End
(16*1.5/14*1.5/286)



FI1419
Rack End
(14*1.5/14*1.5/292)



FI1420
Rack End
(16*1.5/14*1.5/300)



FI1913
Lower Ball Joint
(Ø13.6)



FI1913
Lower Ball Joint
(Ø13.6)



FI2122
Lower Control Arm Bush

FI2034
Lower Control Arm
Man Steerin 00-02



FI2035
Lower Control Arm
Man Steerin 00-02



FI2127 / FI2128
Lower Control Arm Bush

FI2122
Lower Control Arm Bush

FI1916
Lower Ball Joint
(Ø15)



FI2036
Lower Control Arm
Pow Steering 00-02

FI2129 / FI2130
Lower Control Arm Bush



FI2037
Lower Control Arm
Pow Steering 00-02



FI1916
Lower Ball Joint
(Ø15)

FI1917
Lower Ball Joint
(Ø13.1)



FI2038
Lower Control Arm
Pow Steering 02-

FI2122
Lower Control Arm Bush



FI2039
Lower Control Arm
Pow Steering 02-



FI1917
Lower Ball Joint
(Ø13.1)

FI2815
Shock Mounting



FI2816
Shock Mounting



FI2129 / FI2130
Lower Control Arm Bush

LEFT

RIGHT

FIAT

PANDA

FRONT

169

Year

2003-2012

FI1010
Outer Tie Rod End
(Ø11.3*Ø13.71/M12*1.5)

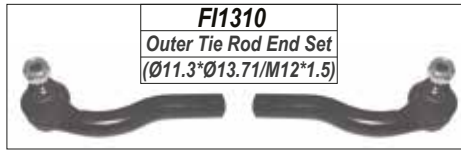

FI1310
Outer Tie Rod End Set
(Ø11.3*Ø13.71/M12*1.5)

FI1011
Outer Tie Rod End
(Ø11.3*Ø13.71/M12*1.5)



FI1421
Rack End
(14*1.5/12*1.5/223)



FI1517
Link Stabilizer
L=315



FI2040
Lower Control Arm

FI2041
Lower Control Arm

PANDA

REAR

FI1518
Link Stabilizer
L=81



LEFT

RIGHT

FIAT

PANDA

FRONT

312

Year

2012-

FI1026
Outer Tie Rod End
(Ø11.28*Ø13.95/M12*1.5)



FI1322
Outer Tie Rod End Set
(Ø11.28*Ø13.95/M12*1.5)

FI1026
Outer Tie Rod End
(Ø11.28*Ø13.95/M12*1.5)



FI1427
Rack End
(14*1.5/12*1.5/253)



FI1527
Link Stabilizer
L=287



FI2140
Lower Control Arm Bush

FI1920
Lower Ball Joint
(Ø15)



FI2056
Lower Control Arm

FI2057
Lower Control Arm

FI1920
Lower Ball Joint
(Ø15)



FI2141
Lower Control Arm Bush



LEFT

RIGHT

FIAT

PUNTO

FRONT

ALL MODELS

Year

2000-2005

FI1020
Outer Tie Rod End
(Ø12*Ø13/M12*1.5)

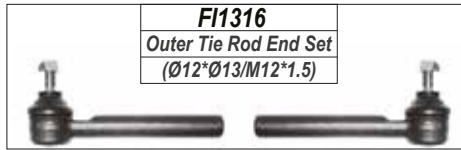

FI1316
Outer Tie Rod End Set
(Ø12*Ø13/M12*1.5)

FI1422
Rack End
(16*1.5/12*1.5/276)



FI1020
Outer Tie Rod End
(Ø12*Ø13/M12*1.5)



AF1530
Link Stabilizer
L=301



FI2042
Lower Control Arm

FI2043
Lower Control Arm

FI2810
Shock Mounting



FI2810
Shock Mounting



LEFT

RIGHT

FIAT

**PUNTO
GRANDE PUNTO**

FRONT

ALL MODELS

Year

2005-

AF1026
Outer Tie Rod End
(Ø11.8*Ø14.8/M14*1.5)

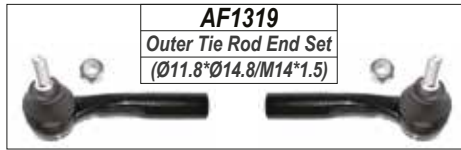

AF1319
Outer Tie Rod End Set
(Ø11.8*Ø14.8/M14*1.5)

AF1027
Outer Tie Rod End
(Ø11.8*Ø14.8/M14*1.5)



FI1417
Rack End
(14*1.5/14*1.5/289)



AF1530
Link Stabilizer
L=301



AF2122
Lower Control Arm Bush



AF1913
Lower Ball Joint
(Ø20.55)



AF1913
Lower Ball Joint
(Ø20.55)



AF2026
Lower Control Arm



AF2027
Lower Control Arm

AF2123
Lower Control Arm Bush

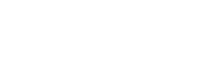

FI2811
Shock Mounting



FI2811
Shock Mounting



LEFT

RIGHT

FIAT

SEICENTO

FRONT

Year

ALLMODELS

2001-2003



LEFT

RIGHT

FIAT

STILO

FRONT

ALL MODELS

Year

2003-

FI1014
Outer Tie Rod End
(Ø11.72*Ø14.8/M14*1.5)



FI1312
Outer Tie Rod End Set
(Ø11.72*Ø14.8/M14*1.5)

FI1411
Rack End
(14*1.5/14*1.5/311)

FI1014
Outer Tie Rod End
(Ø11.72*Ø14.8/M14*1.5)



AF1517 / AF1518
Link Stabilizer
L=116



FI2116
Lower Control Arm Bush



FI2046
Lower Control Arm

FI2047
Lower Control Arm

FI2112
Lower Control Arm Bush

FI2116
Lower Control Arm Bush

FI1912
Lower Ball Joint
(Ø17)



FI2018
Lower Control Arm

FI2117
Lower Control Arm Bush

FI1912
Lower Ball Joint
(Ø17)



FI2019
Lower Control Arm

LEFT

RIGHT

FIAT
STRADA

FRONT

ALL MODELS

Year

2005-

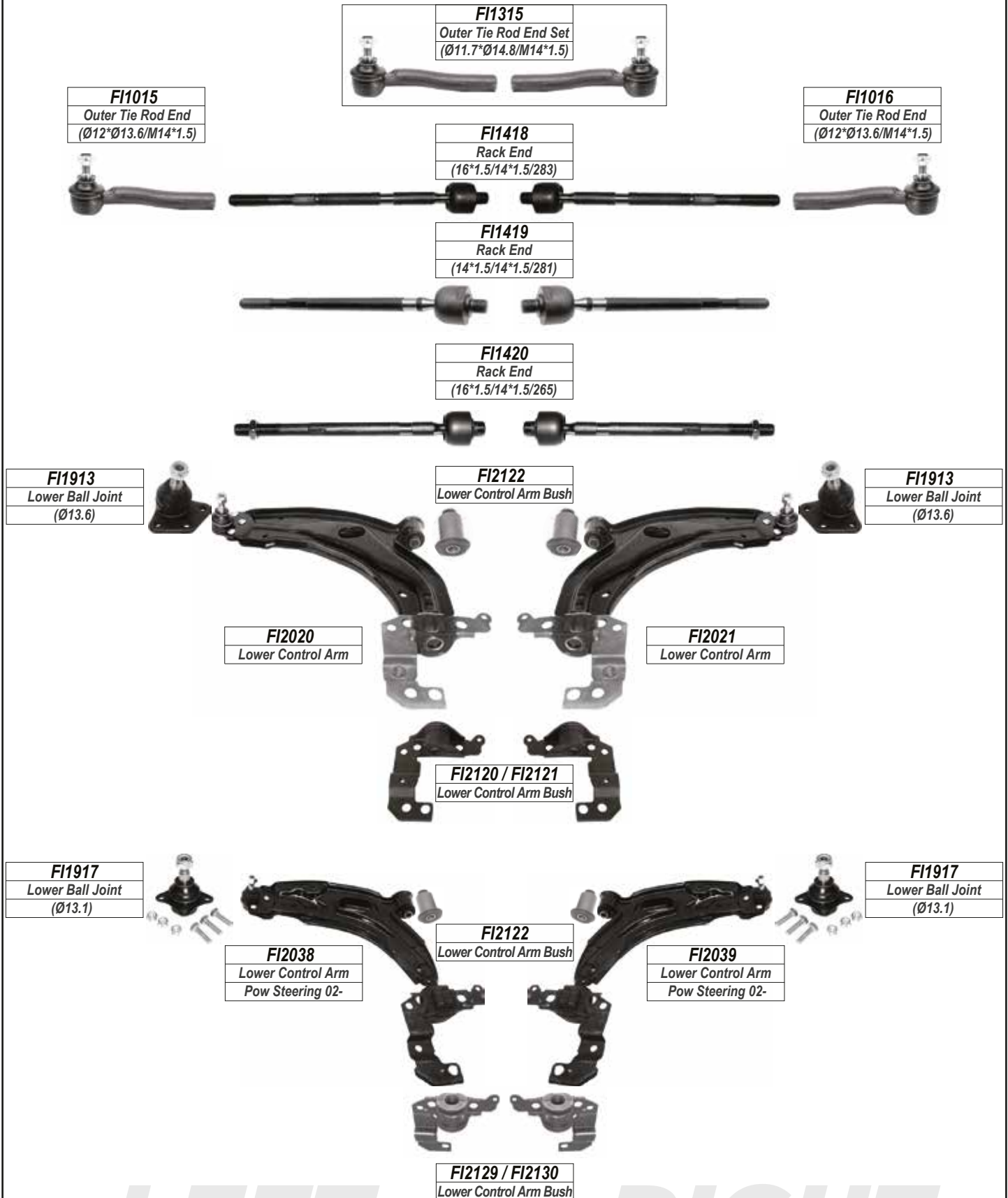

LEFT

RIGHT

FIAT

ULYSSE

FRONT

ALL MODELS

Year

1994-2002

FI1022
Outer Tie Rod End
(Ø12.65*Ø14.5/M14*1.5)

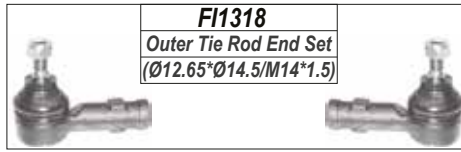

FI1318
Outer Tie Rod End Set
(Ø12.65*Ø14.5/M14*1.5)

FI1417
Rack End
(14*1.5/14*1.5/301)

FI1022
Outer Tie Rod End
(Ø12.65*Ø14.5/M14*1.5)

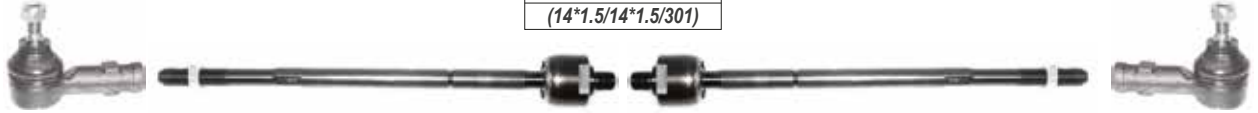

AF1519
Link Stabilizer
L=122



AF2132
Lower Control Arm Bush



FI2048
Lower Control Arm

FI2049
Lower Control Arm

AF2133 / AF2134
Lower Control Arm Bush

LEFT

RIGHT

FIAT

ULYSSE

FRONT

ALL MODELS

Year

2002-

FI1023
Outer Tie Rod End
(Ø13.6*Ø15.5/M14*1.5)

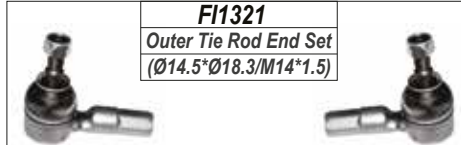
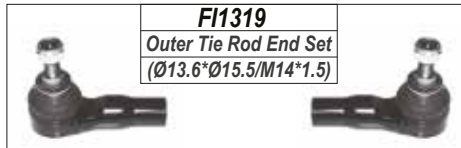

FI1023
Outer Tie Rod End
(Ø13.6*Ø15.5/M14*1.5)



FI1424
Rack End
(14*1.5/14*1.5/313)



FI1024
Outer Tie Rod End
(Ø14.5*Ø18.3/M14*1.5)



FI1024
Outer Tie Rod End
(Ø14.5*Ø18.3/M14*1.5)



AF1520
Link Stabilizer
L=263



AF2132
Lower Control Arm Bush



FI2050
Lower Control Arm

FI2051
Lower Control Arm

AF2135 / AF2136
Lower Control Arm Bush

LEFT

RIGHT

FIAT

UNO

FRONT

ALL MODELS

Year

1990-2005



UNO

REAR



LEFT

RIGHT

FORD

BANTAM

FRONT

ALL

Year

1983-1994

FO1025
Outer Tie Rod End
(Ø11.55*Ø13.3/M12*20)

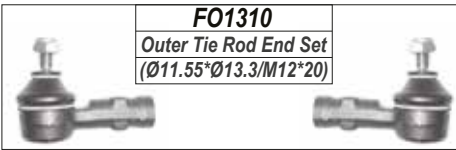

FO1310
Outer Tie Rod End Set
(Ø11.55*Ø13.3/M12*20)

FO1025
Outer Tie Rod End
(Ø11.55*Ø13.3/M12*20)



FO1421
Rack End
(14*1.5/12*20/290)



FO1510
Link Stabilizer
L=239



FO2110
Lower Control Arm Bush



FO2111
Lower Control Arm Bush



FO2110
Lower Control Arm Bush



FO2010
Lower Control Arm
1983-1986



FO2011
Lower Control Arm
1983-1986

FO2110
Lower Control Arm Bush



FO2111
Lower Control Arm Bush



FO2110
Lower Control Arm Bush



FO2012
Lower Control Arm
1986-1994



FO2013
Lower Control Arm
1986-1994

FO2810
Stabilizer Bar Bush



FO2811
Stabilizer Bar Bush



LEFT

RIGHT

FORD

BANTAM

FRONT

ALL

Year

1994-2002

FO1026
Outer Tie Rod End
(Ø12.9*Ø14/M12*1.5)



FO1311
Outer Tie Rod End Set
(Ø12.9*Ø14/M12*1.5)
Power Steering

FO1026
Outer Tie Rod End
(Ø12.9*Ø14/M12*1.5)



FO1422
Rack End(PS)
(17*1.0/12*1.25/306)

FO1027
Outer Tie Rod End
(Ø11.5*Ø13.8/M14*2)



FO1312
Outer Tie Rod End Set
(Ø11.5*Ø13.8/M14*2)
Alt.

FO1028
Outer Tie Rod End
(Ø11.5*Ø13.8/M14*2)



FO1029
Outer Tie Rod End
(Ø13.2*Ø15.1/M12*1.25)

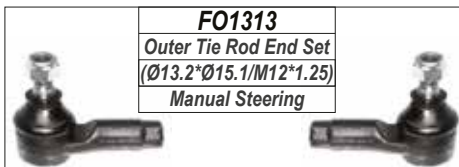

FO1313
Outer Tie Rod End Set
(Ø13.2*Ø15.1/M12*1.25)
Manual Steering

FO1029
Outer Tie Rod End
(Ø13.2*Ø15.1/M12*1.25)



FO1410
Rack End(MS)
(14*1.5/12*1.5/305)

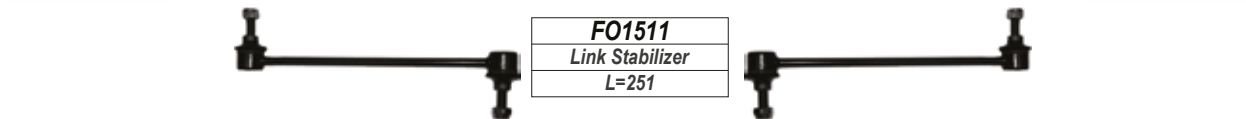

FO1511
Link Stabilizer
L=251

FO1912
Lower Ball Joint
(Ø16)



FO2145
Lower Control Arm Bush

FO2014
Lower Control Arm



FO2015
Lower Control Arm

FO1912
Lower Ball Joint
(Ø16)



FO2812
Stabilizer Bar Bush



FO2812
Stabilizer Bar Bush



FO2817
Shock Mounting



FO2817
Shock Mounting



FO2112
Lower Control Arm Bush



LEFT

RIGHT

FORD

BANTAM

FRONT

ROCAM

Year

2003-

FO1027
Outer Tie Rod End
(Ø11.5*Ø13.8/M14*2)

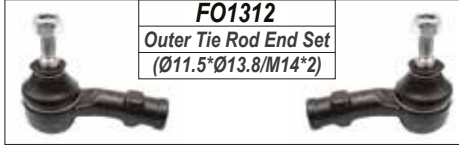

FO1312
Outer Tie Rod End Set
(Ø11.5*Ø13.8/M14*2)

FO1028
Outer Tie Rod End
(Ø11.5*Ø13.8/M14*2)



FO1423
Rack End
(14*1.5/14*2.0/307)

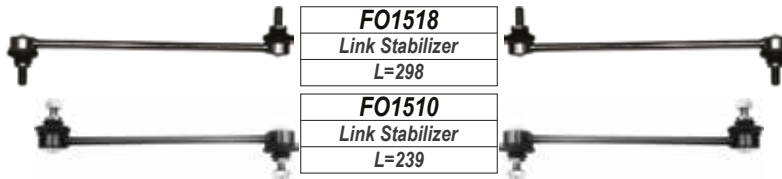

FO1518
Link Stabilizer
L=298

FO1510
Link Stabilizer
L=239

FO2113
Lower Control Arm Bush



FO2016
Lower Control Arm

FO2017
Lower Control Arm



FO2114
Lower Control Arm Bush

FO2113
Lower Control Arm Bush



FO2028
Lower Control Arm

FO2029
Lower Control Arm

FO2114
Lower Control Arm Bush

FO2114
Lower Control Arm Bush

FO2818
Shock Mounting



FO2818
Shock Mounting



LEFT

RIGHT

FORD

B-MAX

FRONT

1.0 ECOBOOST

Year

2015-

FO1010
Outer Tie Rod End
(Ø12.9*Ø15.65/M14*1.5)

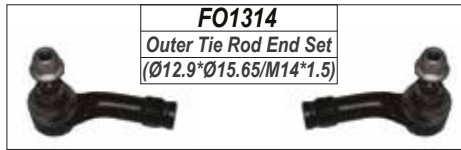

FO1314
Outer Tie Rod End Set
(Ø12.9*Ø15.65/M14*1.5)

FO1411
Rack End
(14*1.5/14*1.5/295)



FO1011
Outer Tie Rod End
(Ø12.9*Ø15.65/M14*1.5)



FO1512
Link Stabilizer
L=251



FO1910
Lower Ball Joint
(Ø17.5)



FO2018
Lower Control Arm

FO2019
Lower Control Arm

FO1910
Lower Ball Joint
(Ø17.5)



B-MAX

REAR

FO2820
Shock Mounting



FO2820
Shock Mounting



LEFT

RIGHT

FORD

COURIER

FRONT

2WD

Year

1986-2000

FO1316

Outer Tie Rod End Set
(Ø13.25*Ø15/M14*1.5)

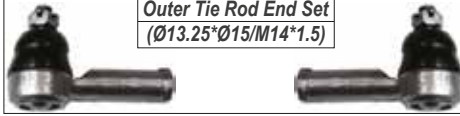

FO1315(Pin)15mm

Inner Tie Rod End Set
(Ø15*Ø17/M14*1.5)



FO1317(Pin)14mm

Inner Tie Rod End Set
(Ø14*Ø15/M14*1.5)



FO1030

Outer Tie Rod End
(Ø13.25*Ø15/M14*1.5)



FO1111(Pin)15mm

Inner Tie Rod End
(Ø15*Ø17/M14*1.5)



FO1030

Outer Tie Rod End
(Ø13.25*Ø15/M14*1.5)



FO1112(Pin)14mm

Inner Tie Rod End
(Ø14*Ø15/M14*1.5)



FO1611

Upper Ball Joint
(Ø13.6)



FO1810

Upper Control Arm Bush



FO1611

Upper Ball Joint
(Ø13.6)



FO1710

Upper Control Arm



FO1711

Upper Control Arm

FO1914

Lower Ball Joint
(Ø18)



FO1914

Lower Ball Joint
(Ø18)



FO2020

Lower Control Arm



FO2021

Lower Control Arm

FO2410

Idler Arm



CA2110

Lower Control Arm Bush



FO2512

Pitman Arm
Spline : 27mm / (Ø10)



FO2513

Pitman Arm
25 mm Spline



LEFT

RIGHT

FORD

COURIER

FRONT

4WD

Year

1990-2000

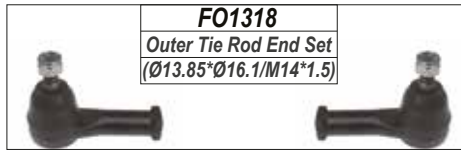

FO1318
Outer Tie Rod End Set
(Ø13.85*Ø16.1/M14*1.5)



FO1315(Pin)15mm
Inner Tie Rod End Set
(Ø15*Ø17/M14*1.5)



FO1317(Pin)14mm
Inner Tie Rod End Set
(Ø14*Ø15/M14*1.5)

FO1031
Outer Tie Rod End
(Ø13.85*Ø16.1/M14*1.5)



FO1111(Pin)15mm
Inner Tie Rod End
(Ø15*Ø17/M14*1.5)



FO1031
Outer Tie Rod End
(Ø13.85*Ø16.1/M14*1.5)



FO1112(Pin)14mm
Inner Tie Rod End
(Ø14*Ø15/M14*1.5)



FO1611
Upper Ball Joint
(Ø13.6)



FO1810
Upper Control Arm Bush



FO1611
Upper Ball Joint
(Ø13.6)



FO1712
Upper Control Arm

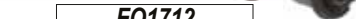

FO1713
Upper Control Arm



FO1915
Lower Ball Joint
(Ø17.75)



FO2115
Lower Control Arm Bush



FO1915
Lower Ball Joint
(Ø17.75)



FO2022
Lower Control Arm



CA2110
Lower Control Arm Bush



FO2023
Lower Control Arm



FO2512
Pitman Arm
Spline : 27mm / (Ø10)

FO2410
Idler Arm



LEFT

RIGHT

FORD

ECOSPORT

FRONT

CBW-CB1

Year

2013-

FO1010
Outer Tie Rod End
(Ø12.9*Ø15.65/M14*1.5)

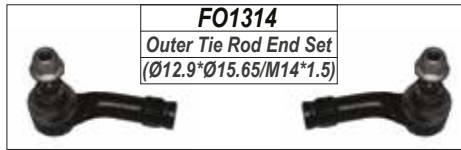

FO1314
Outer Tie Rod End Set
(Ø12.9*Ø15.65/M14*1.5)

FO1411
Rack End
(14*1.5/14*1.5/295)

FO1011
Outer Tie Rod End
(Ø12.9*Ø15.65/M14*1.5)



FO1512
Link Stabilizer
L=251



FO2142
Lower Control Arm Bush



FO1910
Lower Ball Joint
(Ø17.5)



FO2078
Lower Control Arm

FO2079
Lower Control Arm

FO1910
Lower Ball Joint
(Ø17.5)



FO2143
Lower Control Arm Bush



FO2819
Shock Mounting



FO2819
Shock Mounting



ECOSPORT

REAR

FO2820
Shock Mounting



FO2820
Shock Mounting



LEFT

RIGHT

FORD

ESCORT

FRONT

MKI / MKII

Year

1968-1981

FO1025(MK1)
Outer Tie Rod End
(Ø11.55*Ø13.3/M12*20)

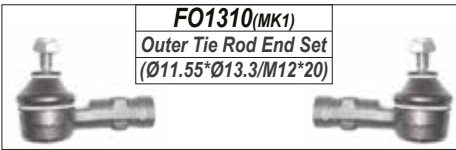

FO1310(MK1)
Outer Tie Rod End Set
(Ø11.55*Ø13.3/M12*20)



FO1421(MK1)
Rack End
(14*1.5/12*20/290)

FO1025(MK1)
Outer Tie Rod End
(Ø11.55*Ø13.3/M12*20)



FO1032(MK2)
Outer Tie Rod End
(Ø12.77*Ø14.7/M14*2)

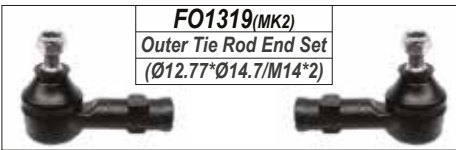

FO1319(MK2)
Outer Tie Rod End Set
(Ø12.77*Ø14.7/M14*2)



FO1424(MK2)
Rack End
(14*1.5/14*2.0/262)

FO1032(MK2)
Outer Tie Rod End
(Ø12.77*Ø14.7/M14*2)



FO2024
Lower Control Arm

FO2116
Lower Control Arm Bush



FO2025
Lower Control Arm

FO2116
Lower Control Arm Bush

FO2810
Stabilizer Bar Bush



LEFT

RIGHT

FORD

ESCORT

FRONT

MKIII /MKIV

Year

1981-1990

FO1025
Outer Tie Rod End
(Ø11.55*Ø13.3/M12*20)

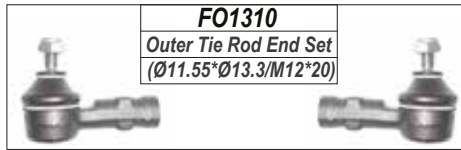

FO1310
Outer Tie Rod End Set
(Ø11.55*Ø13.3/M12*20)

FO1025
Outer Tie Rod End
(Ø11.55*Ø13.3/M12*20)



FO1421
Rack End
(14*1.5/12*20/290)



FO1510
Link Stabilizer
L=239



FO2010
Lower Control Arm
Mk3



FO2011
Lower Control Arm
Mk3

FO2110
Lower Control Arm Bush



FO2111
Lower Control Arm Bush



FO2110
Lower Control Arm Bush



FO2012
Lower Control Arm
Mk4



FO2013
Lower Control Arm
Mk4

FO2810
Stabilizer Bar Bush



FO2811
Stabilizer Bar Bush



LEFT

RIGHT

FORD

ESCORT

FRONT

Z TECH

Year

1990-2000

FO1012
Outer Tie Rod End
(Ø13.27*Ø16.1/M14*20)

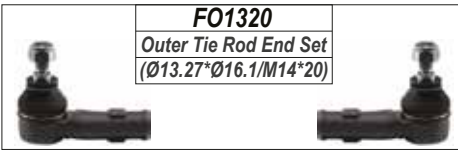

FO1320
Outer Tie Rod End Set
(Ø13.27*Ø16.1/M14*20)

FO1013
Outer Tie Rod End
(Ø13.27*Ø16.1/M14*20)

FO1425
Rack End
(14*1.5/14*2.0/305)

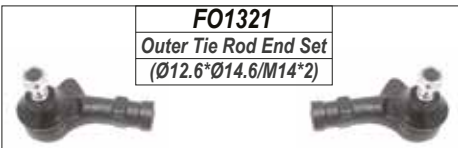

FO1321
Outer Tie Rod End Set
(Ø12.6*Ø14.6/M14*2)

FO1033
Outer Tie Rod End
(Ø12.6*Ø14.6/M14*2)

FO1426
Rack End
(14*1.5/14*2.0/318)

FO1034
Outer Tie Rod End
(Ø12.6*Ø14.6/M14*2)



FO1510
Link Stabilizer
L=239



FO2117
Lower Control Arm Bush



FO1916
Lower Ball Joint
(Ø17)



FO1916
Lower Ball Joint
(Ø17)

FO2026
Lower Control Arm



FO2027
Lower Control Arm



FO2118
Lower Control Arm Bush

FO2810
Stabilizer Bar Bush



FO2821
Shock Mounting



FO2821
Shock Mounting



LEFT

RIGHT

FORD			Year
EVEREST	FRONT	3.0 TDCI	2010-

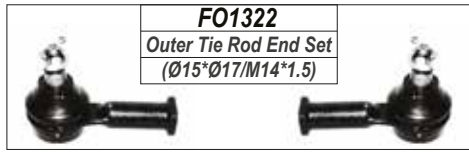

FO1014
Outer Tie Rod End
(Ø15*Ø17/M14*1.5)



FO1110
Inner Tie Rod End
(Ø14.9*Ø17/M14*1.5)



FO1014
Outer Tie Rod End
(Ø15*Ø17/M14*1.5)



FO1611
Upper Ball Joint
(Ø13.6)



FO1611
Upper Ball Joint
(Ø13.6)



FO1722
Upper Control Arm

FO2115
Lower Control Arm Bush

FO1723
Upper Control Arm

FO1917
Lower Ball Joint
(Ø19.4)



FO1917
Lower Ball Joint
(Ø19.4)



FO2022
Lower Control Arm

CA2110
Lower Control Arm Bush

FO2023
Lower Control Arm

FO2411
Idler Arm
10 mm Hole



FO2412
Idler Arm
14 mm Hole



FO2413
Idler Arm
14 mm Hole / Opp Bracket



FO2510
Pitman Arm



LEFT

RIGHT

FORD

FIESTA

FRONT

JA,JB (MK IV)

Year

1997-2004

FO1027
Outer Tie Rod End
(Ø11.5*Ø13.8/M14*2)

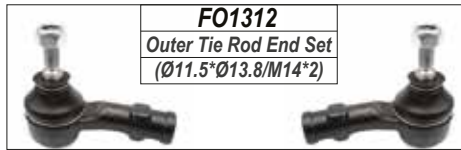

FO1312
Outer Tie Rod End Set
(Ø11.5*Ø13.8/M14*2)

FO1423
Rack End
(14*1.5/14*2.0/313)



FO1028
Outer Tie Rod End
(Ø11.5*Ø13.8/M14*2)



FO1438
Rack End
(14*1.5/14*2.0/287)



FO1510
Link Stabilizer
L=239

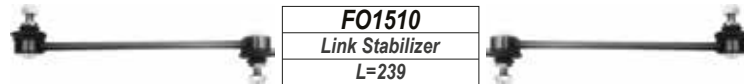

FO2113
Lower Control Arm Bush



FO2016
Lower Control Arm

FO2017
Lower Control Arm

FO2114
Lower Control Arm Bush

FO2113
Lower Control Arm Bush

FO2113
Lower Control Arm Bush



FO2028
Lower Control Arm

FO2029
Lower Control Arm

FO2114
Lower Control Arm Bush

FO1913
Lower Ball Joint
(Ø16.5)



FO1913
Lower Ball Joint
(Ø16.5)



FO2818
Shock Mounting



FO2818
Shock Mounting



LEFT

RIGHT

FORD

FIESTA

FRONT

DJ1,HJ1 (MK V)

Year

2004-2008

FO1035
Outer Tie Rod End
(Ø11.55*Ø13.8/M14*1.5)

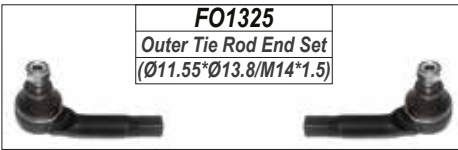

FO1325
Outer Tie Rod End Set
(Ø11.55*Ø13.8/M14*1.5)

FO1435
Rack End
(14*1.5/14*1.5/277)



FO1036
Outer Tie Rod End
(Ø11.55*Ø13.8/M14*1.5)



FO1514
Link Stabilizer
L=283

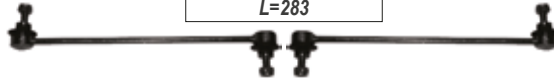

FO2120
Lower Control Arm Bush

FO1918
Lower Ball Joint
(Ø17.5)



FO2032
Lower Control Arm



FO2033
Lower Control Arm



FO1918
Lower Ball Joint
(Ø17.5)



FO2119
Lower Control Arm Bush



FO2822
Shock Mounting



FO2822
Shock Mounting



FIESTA

REAR

FO2824
Shock Mounting



FO2824
Shock Mounting



LEFT

RIGHT

FORD

FIESTA

FRONT

JG, JJ, KC, KD, WZ (MK VI)

Year

2008-

FO1010
Outer Tie Rod End
(Ø12.9*Ø15.65/M14*1.5)

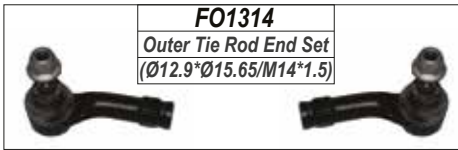

FO1314
Outer Tie Rod End Set
(Ø12.9*Ø15.65/M14*1.5)

FO1411
Rack End
(14*1.5/14*1.5/295)



FO1011
Outer Tie Rod End
(Ø12.9*Ø15.65/M14*1.5)



FO1037
Outer Tie Rod End
(Ø15.6*Ø12.34/M14*1.5)

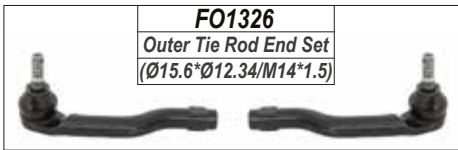

FO1326
Outer Tie Rod End Set
(Ø15.6*Ø12.34/M14*1.5)

FO1427
Rack End
(14*1.5/14*1.5/213)



FO1038
Outer Tie Rod End
(Ø15.6*Ø12.34/M14*1.5)



FO1512
Link Stabilizer
L=251



FO1514
Link Stabilizer
L=282



FO2121
Lower Control Arm Bush



FO1910
Lower Ball Joint
(Ø17.5)



FO2034
Lower Control Arm

FO2035
Lower Control Arm

FO1910
Lower Ball Joint
(Ø17.5)



FO2819
Shock Mounting



FO2819
Shock Mounting



FO2823
Shock Mounting



FO2122
Lower Control Arm Bush



FO2823
Shock Mounting



FIESTA

REAR

FO2820
Shock Mounting



FO2820
Shock Mounting



LEFT

RIGHT

FORD

FIESTA

FRONT

HF,HJ (MK VII)

Year

2017-

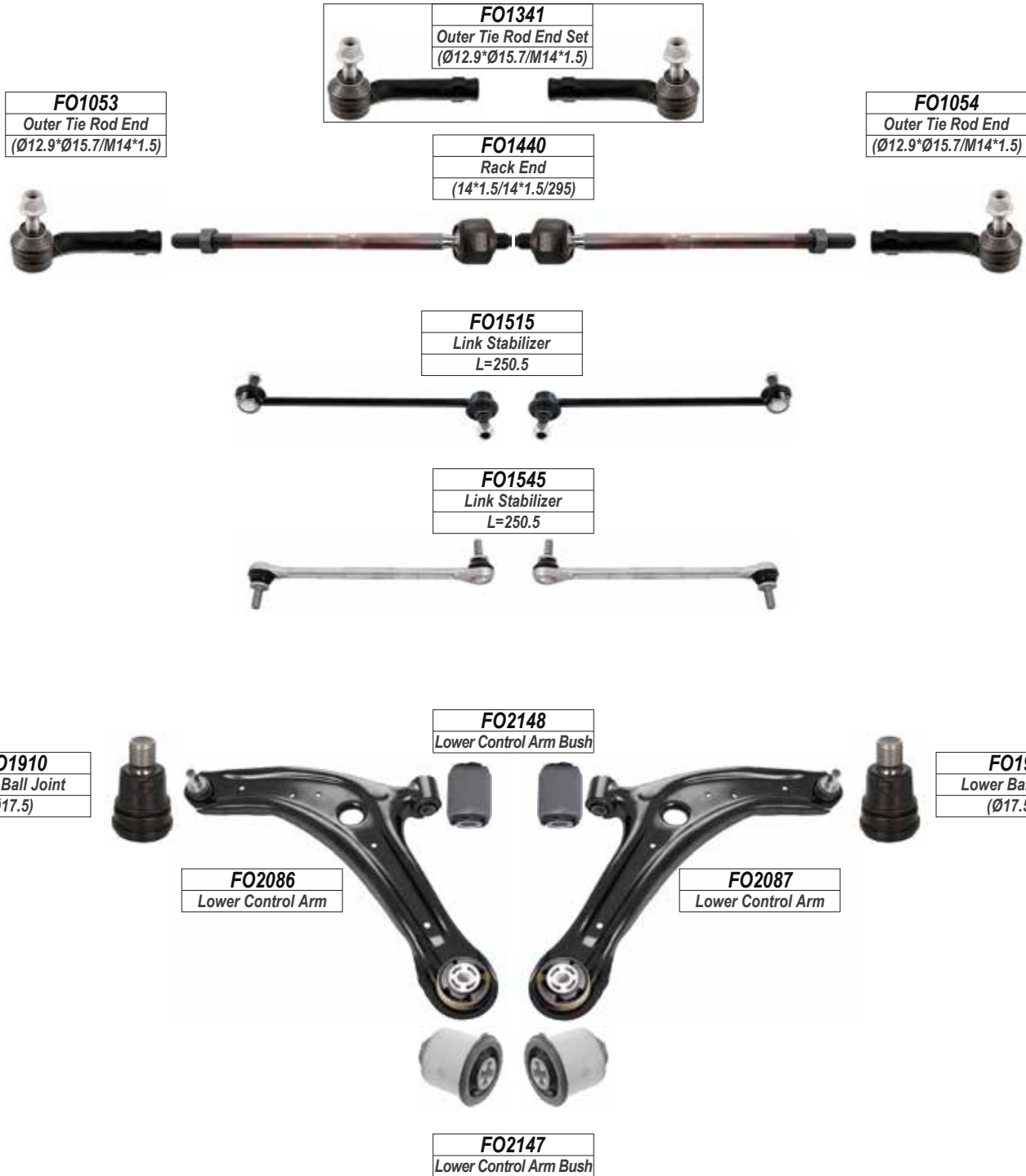

LEFT

RIGHT

FORD

Year

FIGO

FRONT

1.4 1.4 TDCI

2010-2016

FO1035
Outer Tie Rod End
(Ø11.55*Ø13.8/M14*1.5)



FO1325
Outer Tie Rod End Set
(Ø11.55*Ø13.8/M14*1.5)

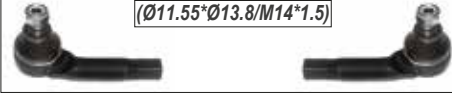

FO1435
Rack End
(14*1.5/14*1.5/277)



FO1036
Outer Tie Rod End
(Ø11.55*Ø13.8/M14*1.5)



FO1514
Link Stabilizer
L=283

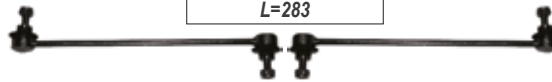

FO2120
Lower Control Arm Bush



FO1919
Lower Ball Joint
(Ø18)



FO1919
Lower Ball Joint
(Ø18)



FO2036
Lower Control Arm



FO2037
Lower Control Arm



FO2822
Shock Mounting



FO2123
Lower Control Arm Bush



FO2822
Shock Mounting



FIGO

REAR

FO2824
Shock Mounting



FO2824
Shock Mounting



LEFT

RIGHT

FORD

FIGO

FRONT

ALL

Year

2016-

FO1010
Outer Tie Rod End
(Ø12.9*Ø15.65/M14*1.5)

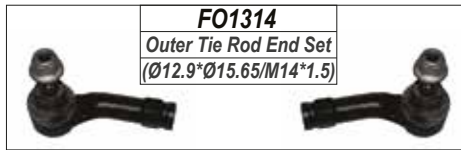

FO1314
Outer Tie Rod End Set
(Ø12.9*Ø15.65/M14*1.5)

FO1413
Rack End
(14*1.5/14*1.5/311)



Outer Tie Rod End
(Ø12.9*Ø15.65/M14*1.5)



FO1515
Link Stabilizer
L=250.5

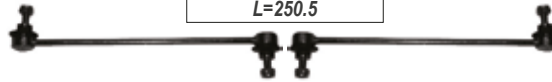

FO2121
Lower Control Arm Bush



FO1910
Lower Ball Joint
(Ø17.5)



FO2034
Lower Control Arm



FO2035
Lower Control Arm

FO1910
Lower Ball Joint
(Ø17.5)



FO2122
Lower Control Arm Bush



FO2819
Shock Mounting



FO2819
Shock Mounting



FIGO

REAR

FO2820
Shock Mounting



FO2820
Shock Mounting



LEFT

RIGHT

FORD
FOCUS
FRONT
I

Year

2000-2005

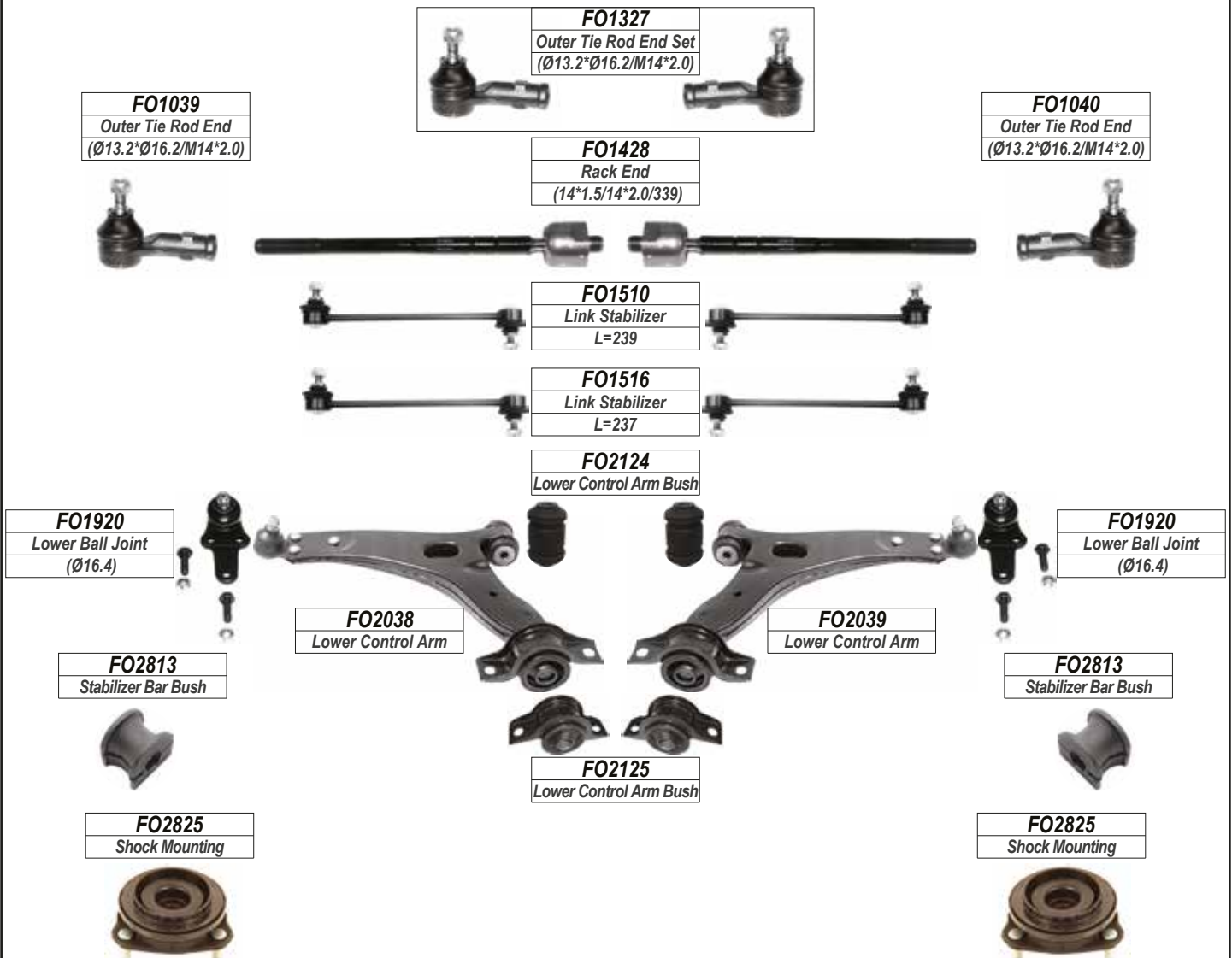
FOCUS
REAR

LEFT

RIGHT

FORD

FOCUS

FRONT

II

Year

2005-2009

FO1041
Outer Tie Rod End
(Ø12.3*Ø16/M16*1.5)



FO1328
Outer Tie Rod End Set
(Ø12.3*Ø16/M16*1.5)

FO1429
Rack End
(14*1.5/16*1.5/291)



FO1042
Outer Tie Rod End
(Ø12.3*Ø16/M16*1.5)



FO1430
Rack End
(14*1.5/16*1.5/293)



FO1518
Link Stabilizer
L=298



MA2110
Lower Control Arm Bush

FO1921
Lower Ball Joint
(Ø19)



FO1921
Lower Ball Joint
(Ø19)



FO2041
Lower Control Arm

FO2042
Lower Control Arm

FO2127
Lower Control Arm Bush

FO1922
Lower Ball Joint
(Ø21)



FO1922
Lower Ball Joint
(Ø21)



FO2043
Lower Control Arm

FO2044
Lower Control Arm

FO2826
Shock Mounting



FO2826
Shock Mounting



FO2127
Lower Control Arm Bush

LEFT

RIGHT

FORD

FOCUS

REAR

II

Year

2005-2009

FO1519
Link Stabilizer
L=110



FO1520
Link Stabilizer
L=76



FO1521
Link Stabilizer
L=109



FO2126
Lower Control Arm Bush



FO2040
Lower Control Arm



FO2040
Lower Control Arm



FO2045
Lower Control Arm



FO2045
Lower Control Arm

FO2911
Bush

FO2911
Bush



FO2911
Bush

FO2613
Lateral Link
L=223

FO2613
Lateral Link
L=223

FO2910
Bush



LEFT

RIGHT

FORD

FOCUS

FRONT

III

Year

2010-

FO1043
Outer Tie Rod End
(Ø12.35*Ø16.1/M16*1.5)

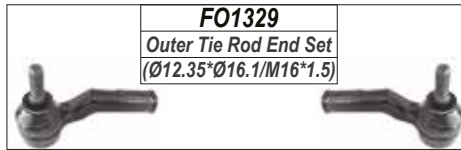

FO1329
Outer Tie Rod End Set
(Ø12.35*Ø16.1/M16*1.5)

FO1431
Rack End
(14*1.5/16*1.5/290)

FO1044
Outer Tie Rod End
(Ø12.35*Ø16.1/M16*1.5)



FO1041
Outer Tie Rod End
(Ø12.3*Ø16/M16*1.5)



FO1328
Outer Tie Rod End Set
(Ø12.3*Ø16/M16*1.5)

FO1432
Rack End
(14*1.5/16*1.5/295)

FO1042
Outer Tie Rod End
(Ø12.3*Ø16/M16*1.5)

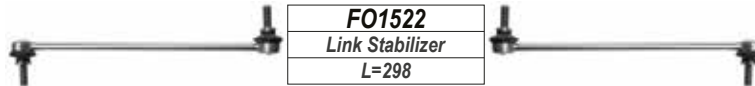

FO1522
Link Stabilizer
L=298

FO2129
Lower Control Arm Bush



FO2046
Lower Control Arm
Aluminium

FO2047
Lower Control Arm
Aluminium



FO1923
Lower Ball Joint
(Ø21)



FO1924
Lower Ball Joint
(Ø21)



FO2128
Lower Control Arm Bush

FO2129
Lower Control Arm Bush



FO2048
Lower Control Arm
Metal

FO2049
Lower Control Arm
Metal



FO2826
Shock Mounting



FO2826
Shock Mounting



FO2128
Lower Control Arm Bush

LEFT

RIGHT

FORD

FOCUS

REAR

III

Year

2010-

FO1521
Link Stabilizer
L=109



FO1525
Link Stabilizer
L=76 (2014-)



FO1523
Link Stabilizer
L=50 (1.6)



FO1524
Link Stabilizer
L=50 (2.0)

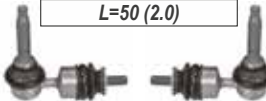

LEFT

RIGHT

FORD

FUSION

REAR

1.5.2.0 2.0TDCI

Year

2015-

FO1051
Outer Tie Rod End
(Ø16*/M18*1.5)

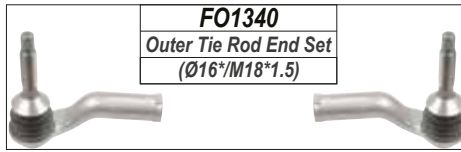

FO1340
Outer Tie Rod End Set
(Ø16*/M18*1.5)

FO1436
Rack End
(16*1.5 / 18*1.5/304)



FO1052
Outer Tie Rod End
(Ø16*/M18*1.5)



FO1542
Link Stabilizer
L=300



FO2080
Lower Control Arm



FO2081
Lower Control Arm



FUSION

REAR

FO1524
Link Stabilizer
L=76.4



LEFT

RIGHT

FORD

IKON

FRONT

ALL MODELS

Year

2001-

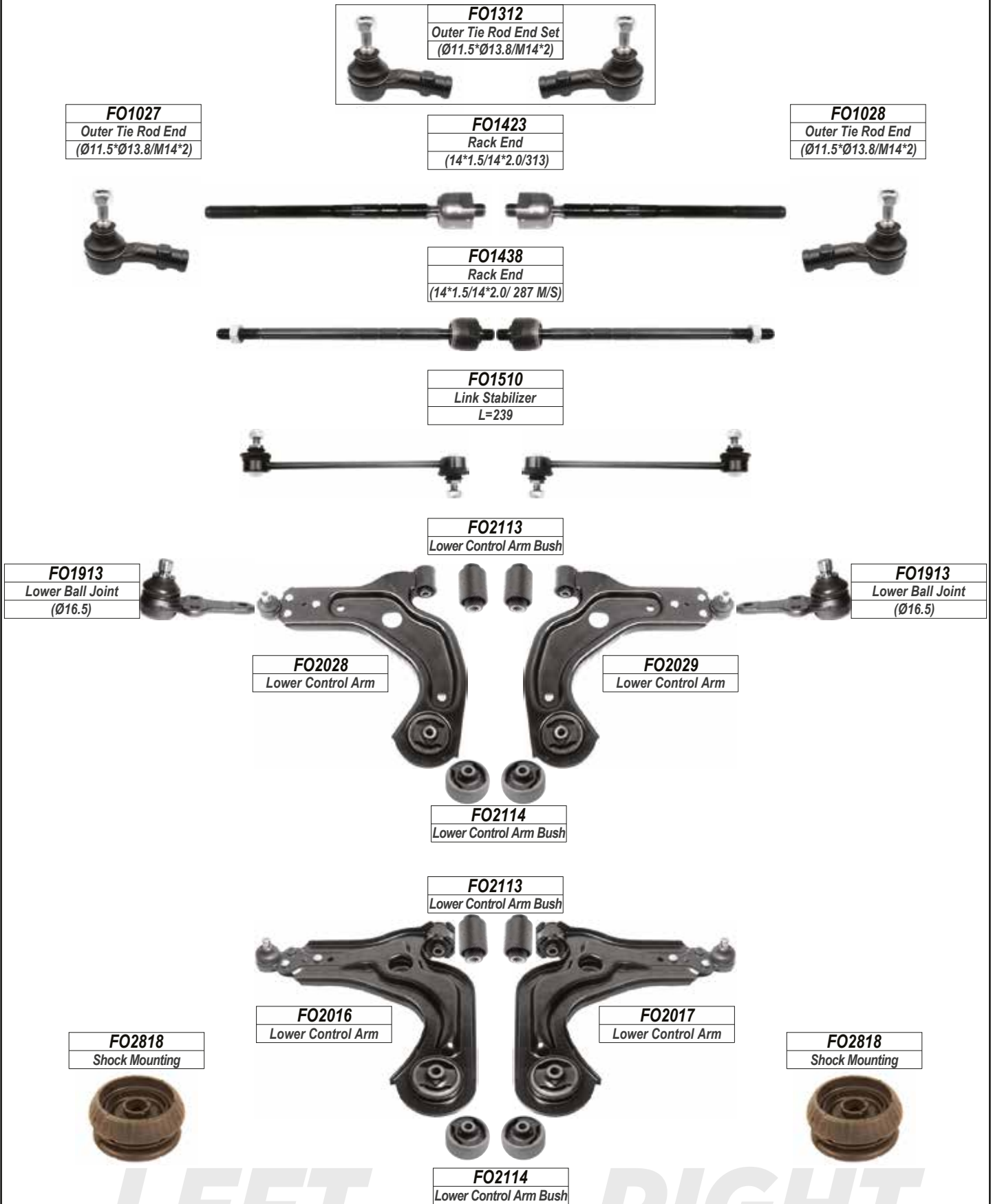

LEFT

RIGHT

FORD

IKON

FRONT

ALL MODELS

Year

2007-

FO1035
Outer Tie Rod End(M/S)
(Ø11.55*Ø13.8/M14*1.5)

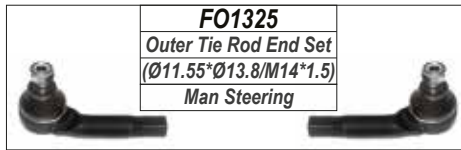

FO1325
Outer Tie Rod End Set
(Ø11.55*Ø13.8/M14*1.5)
Man Steering

FO1036
Outer Tie Rod End(M/S)
(Ø11.55*Ø13.8/M14*1.5)



FO1435
Rack End
(14*1.5/14*1.5/277)(P/S)



FO1514
Link Stabilizer
L=283



FO2120
Lower Control Arm Bush

Lower Control Arm Bush



FO1918
Lower Ball Joint
(Ø17.5)



FO1918
Lower Ball Joint
(Ø17.5)



FO2032
Lower Control Arm



FO2033
Lower Control Arm



FO2119
Lower Control Arm Bush

Lower Control Arm Bush



FO2818
Shock Mounting



FO2818
Shock Mounting



LEFT

RIGHT

FORD

KA

FRONT

ALL MODELS

Year

2005-2009

FO1015
Outer Tie Rod End
(Ø11.6*Ø13.7/M14*1.5)

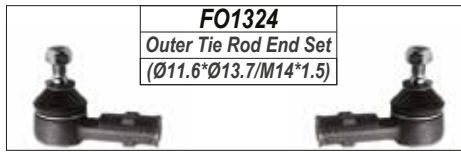

FO1324
Outer Tie Rod End Set
(Ø11.6*Ø13.7/M14*1.5)

FO1439
Rack End
(14*1.5/1/2*20UNF/300)



FO1015
Outer Tie Rod End
(Ø11.6*Ø13.7/M14*1.5)



FO1510
Link Stabilizer
L=239



FO1913
Lower Ball Joint
(Ø16.5)



FO2117
Lower Control Arm Bush



FO2050
Lower Control Arm



FO2051
Lower Control Arm



FO1913
Lower Ball Joint
(Ø16.5)



FO2118
Lower Control Arm Bush



FO2818
Shock Mounting



FO2818
Shock Mounting



LEFT

RIGHT

FORD

KUGA

FRONT

DM2 (MK I, MK II)

Year

2008-

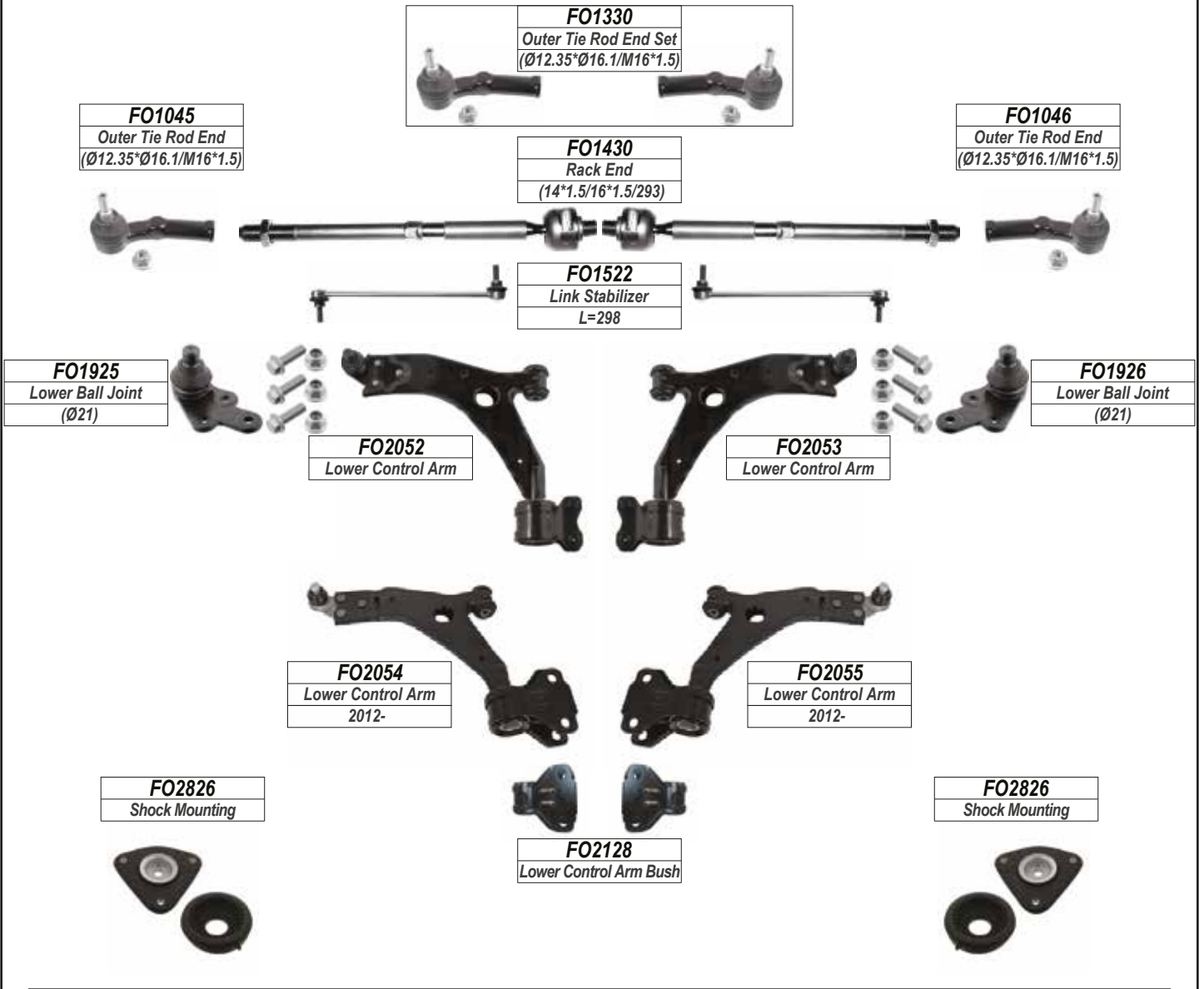

KUGA

REAR

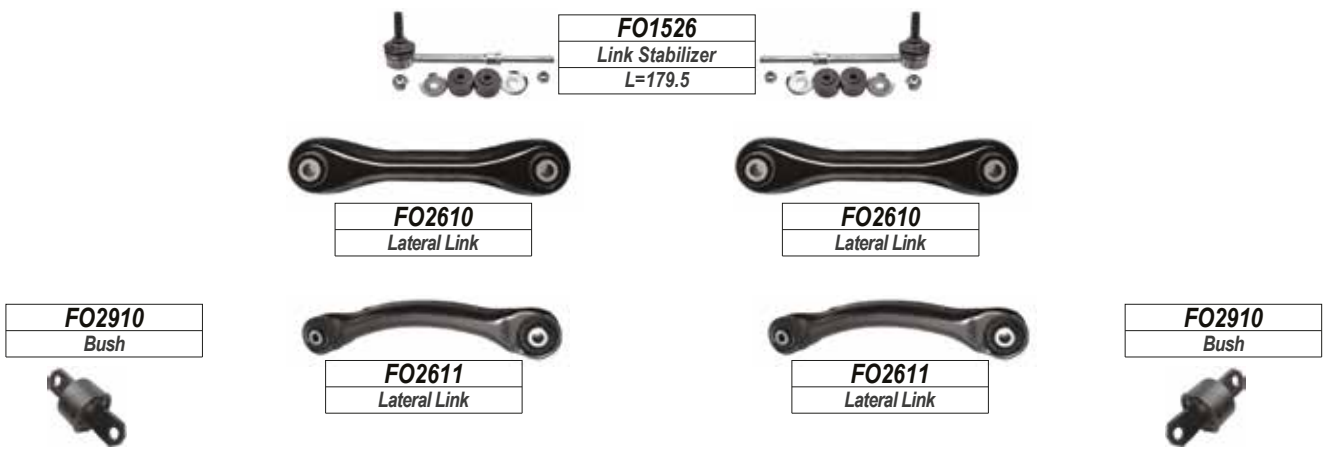

LEFT

RIGHT

FORD

KUGA

FRONT

DFK (MK III)

Year

2019-

FO1043
Outer Tie Rod End
(Ø12.35*Ø16.1/M16*1.5)

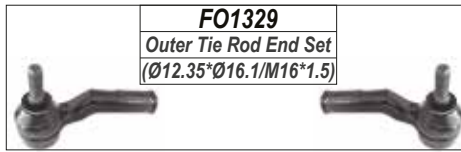

FO1329
Outer Tie Rod End Set
(Ø12.35*Ø16.1/M16*1.5)

FO1431
Rack End
(14*1.5/16*1.5/290)



FO1044
Outer Tie Rod End
(Ø12.35*Ø16.1/M16*1.5)



FO1546
Link Stabilizer
L=318



FO2149
Lower Control Arm Bush

FO1936
Lower Ball Joint
(Ø21)



FO2088
Lower Control Arm



FO2150
Lower Control Arm Bush



FO2089
Lower Control Arm



FO1937
Lower Ball Joint
(Ø21)



LEFT

RIGHT

FORD

LASER.TRACER

FRONT

ALL MODELS

Year

1986-2002

FO1029
Outer Tie Rod End
(Ø13.2*Ø15.1/M12*1.25)

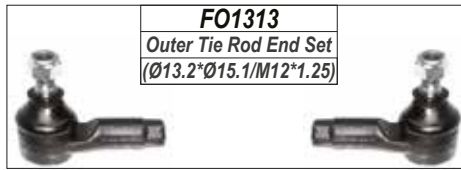

FO1313
Outer Tie Rod End Set
(Ø13.2*Ø15.1/M12*1.25)

FO1422
Rack End
(17*1.0/12*1.25/306)

FO1029
Outer Tie Rod End
(Ø13.2*Ø15.1/M12*1.25)



FO1026
Outer Tie Rod End
(Ø12.9*Ø14/M12*1.5)



FO1311
Outer Tie Rod End Set
(Ø12.9*Ø14/M12*1.5)
Power Steering

FO1410
Rack End
(14*1.5/12*1.5/305)

FO1026
Outer Tie Rod End
(Ø12.9*Ø14/M12*1.5)



FO1912
Lower Ball Joint
(Ø16)



FO2145
Lower Control Arm Bush



FO1912
Lower Ball Joint
(Ø16)



FO2014
Lower Control Arm



FO2015
Lower Control Arm



FO2817
Shock Mounting



FO2817
Shock Mounting



FO2112
Lower Control Arm Bush



FO2827
Shock Mounting



FO2827
Shock Mounting



LEFT

RIGHT

FORD

MONDEO

FRONT

II

Year

1996-2001

FO1016
Outer Tie Rod End
(Ø12.2*Ø14.7/M16*1.5)

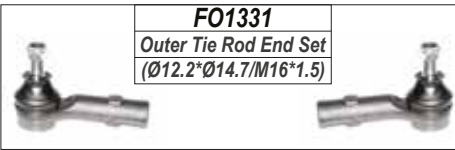

FO1331
Outer Tie Rod End Set
(Ø12.2*Ø14.7/M16*1.5)

FO1433
Rack End
(14*1.5/16*1.5/336)



FO1017
Outer Tie Rod End
(Ø12.2*Ø14.7/M16*1.5)



FO1434
Rack End
(14*1.5/16*1.5/340)



FO1527
Link Stabilizer
L=237.5

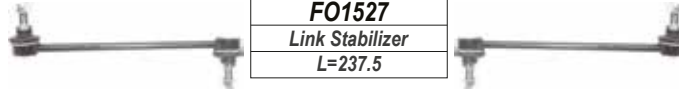

FO2130
Lower Control Arm Bush

FO1927
Lower Ball Joint
(Ø18)



FO2056
Lower Control Arm

FO2057
Lower Control Arm

FO1927
Lower Ball Joint
(Ø18)



FO2132
Lower Control Arm Bush



FO2058
Lower Control Arm

FO2059
Lower Control Arm

FO2131
Lower Control Arm Bush

FO2828
Shock Mounting



FO2828
Shock Mounting



FO2132
Lower Control Arm Bush

MONDEO

REAR



FO1528
Link Stabilizer
L=118.5



FO1529
Link Stabilizer
L=160



FO2612
Lateral Link
L=602

FO2612
Lateral Link
L=602

FO2815
Stabilizer Bar Bush



FO2912
Bush



FO2815
Stabilizer Bar Bush

LEFT

RIGHT

FORD

MONDEO

FRONT

III

Year

2001-2007

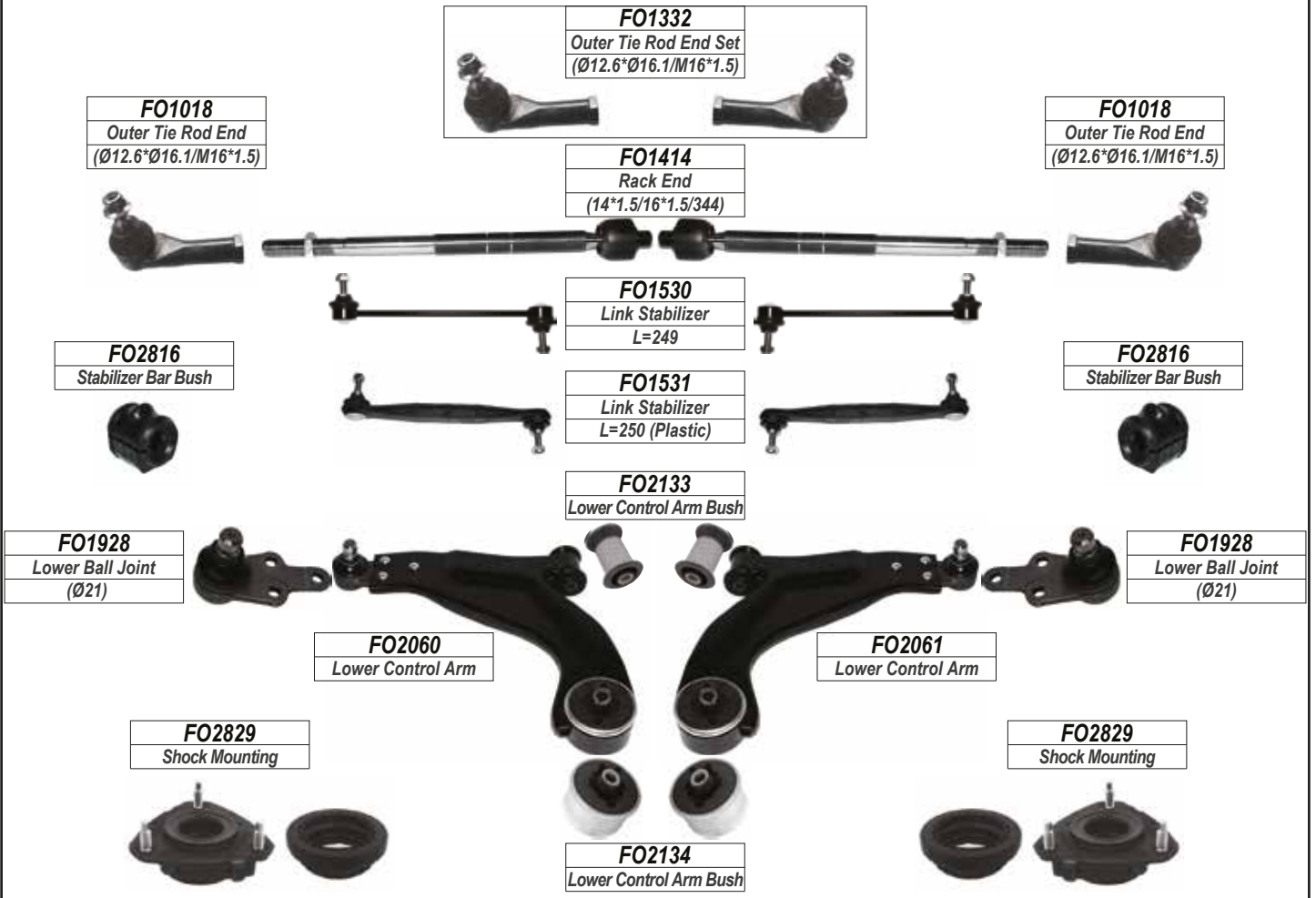

MONDEO REAR

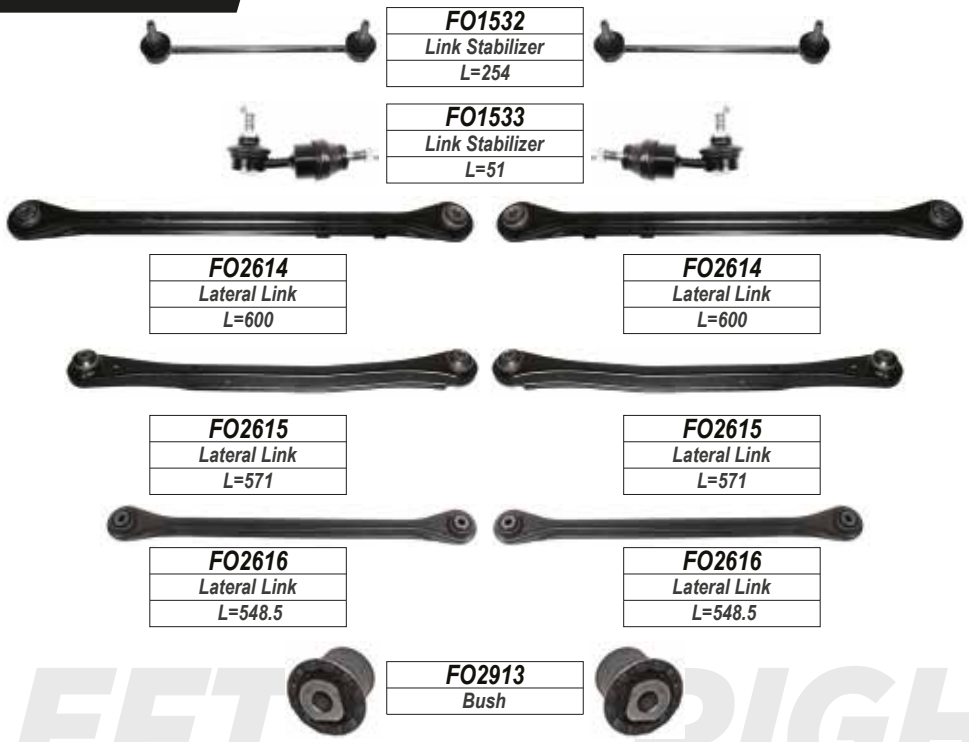

LEFT

RIGHT

FORD

MUSTANG

FRONT

P8U,P8T,P8C,P8F

Year

2014-



LEFT

RIGHT

FORD

RANGER

FRONT

ALL MODELS

Year

2000-2008

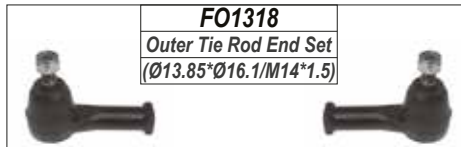
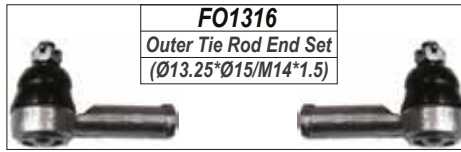

F01030
Outer Tie Rod End
(Ø13.25*Ø15/M14*1.5)



F01112
Inner Tie Rod End
(Ø14*Ø15/M14*1.5)



F01030
Outer Tie Rod End
(Ø13.25*Ø15/M14*1.5)



F01031
Outer Tie Rod End
(Ø13.85*Ø16.1/M14*1.5)



F01111
Inner Tie Rod End
(Ø15*Ø17/M14*1.5)



F01031
Outer Tie Rod End
(Ø13.85*Ø16.1/M14*1.5)



F02710
Repair Kit



F01810
Upper Control Arm Bush



F01811
Upper Control Arm Bush



F01713
Upper Control Arm
Hi Trail



F02710
Repair Kit

F02711
Repair Kit



F01722
Upper Control Arm

F01811
Upper Control Arm Bush



F01723
Upper Control Arm



F02711
Repair Kit

LEFT

RIGHT

FORD

RANGER

FRONT

ALL MODELS

Year

2000-2008

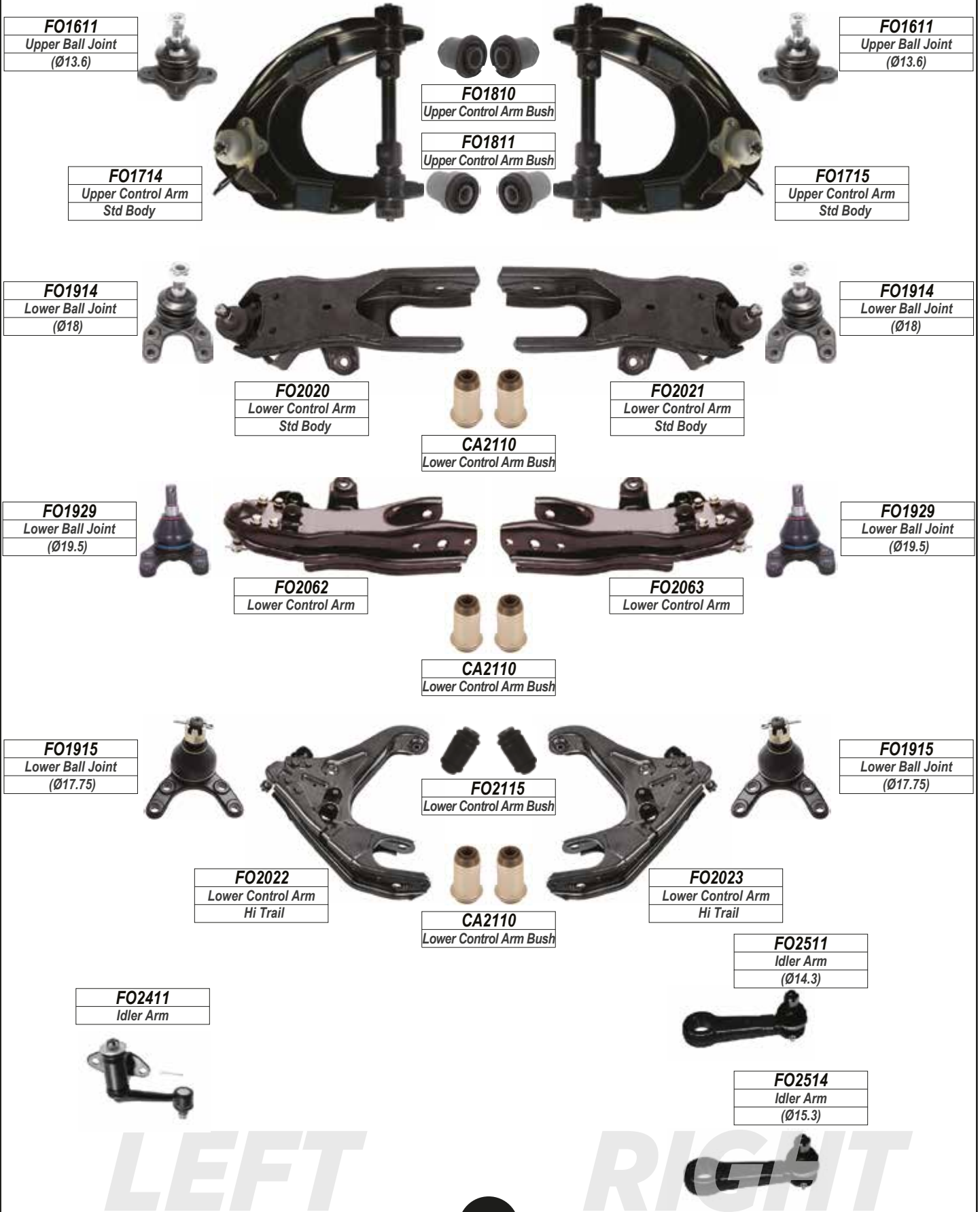

LEFT

RIGHT

FORD

RANGER

FRONT

ALL MODELS

Year

2008-2011

FO1322
Outer Tie Rod End Set
(Ø15*Ø17/M14*1.5)

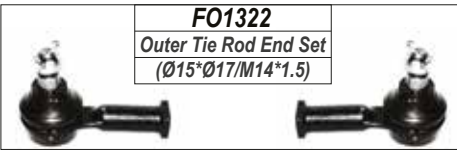

FO1323
Inner Tie Rod End Set
(Ø14.9*Ø17/M14*1.5)



FO1014
Outer Tie Rod End
(Ø15*Ø17/M14*1.5)



FO1110
Inner Tie Rod End
(Ø14.9*Ø17/M14*1.5)



FO1014
Outer Tie Rod End
(Ø15*Ø17/M14*1.5)



FO2710
Repair Kit



FO1810
Upper Control Arm Bush



FO2710
Repair Kit



FO1611
Upper Ball Joint
(Ø13.6)



FO1712
Upper Control Arm
Hi Trail



FO1811
Upper Control Arm Bush



FO1713
Upper Control Arm
Hi Trail



FO1611
Upper Ball Joint
(Ø13.6)



FO2711
Repair Kit



FO1722
Upper Control Arm



FO1723
Upper Control Arm



FO2711
Repair Kit



FO1611
Upper Ball Joint
(Ø13.6)



FO1810
Upper Control Arm Bush



FO1714
Upper Control Arm
Std Body



FO1811
Upper Control Arm Bush



FO1715
Upper Control Arm
Std Body



FO1611
Upper Ball Joint
(Ø13.6)



LEFT

RIGHT

FORD

RANGER

FRONT

ALL MODELS

Year

2008-2011

FO1915

Lower Ball Joint
(Ø17.75)



F02115

Lower Control Arm Bush



FO1915

Lower Ball Joint
(Ø17.75)



FO1917

Lower Ball Joint
(Ø17.8)



CA2110

Lower Control Arm Bush



FO1917

Lower Ball Joint
(Ø17.8)



F02022

Lower Control Arm



F02023

Lower Control Arm



FO1929

Lower Ball Joint
(Ø19.5)



F02062

Lower Control Arm



F02063

Lower Control Arm



CA2110

Lower Control Arm Bush



FO1929

Lower Ball Joint
(Ø19.5)



F02411

Idler Arm
10 mm Hole



F02412

Idler Arm
14 mm Hole



F02413

Idler Arm
14 mm Hole / Opp Bracket



F02510

Pitman Arm



LEFT

RIGHT

FORD

RANGER

FRONT

T6/T7

Year

2011-

FO1047
Outer Tie Rod End
(Ø14.3*Ø17.5/M14*1.5)



FO1333
Outer Tie Rod End Set
(Ø14.3*Ø17.5/M14*1.5)

FO1437
Rack End
(16*1.5/14*1.5/203)



FO1048
Outer Tie Rod End
(Ø14.3*Ø17.5/M14*1.5)



FO1415
Rack End
(14*1.5/14*1.5/201)

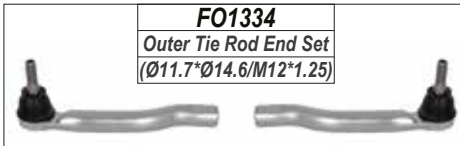

FO1334
Outer Tie Rod End Set
(Ø11.7*Ø14.6/M12*1.25)

FO1049
Outer Tie Rod End
(Ø11.7*Ø14.6/M12*1.25)



FO1050
Outer Tie Rod End
(Ø11.7*Ø14.6/M12*1.25)

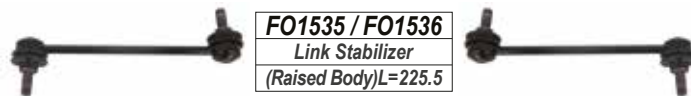

FO1535 / FO1536
Link Stabilizer
(Raised Body)L=225.5



FO1543
Link Stabilizer
(Standart Body)L=255

LEFT

RIGHT

FORD			Year
RANGER	FRONT	T6/T7	2011-



FO1716
Upper Control Arm
(Long-L=226)

FO1717
Upper Control Arm
(Long-L=226)

FO1610
Upper Ball Joint
(Ø18)



FO1610
Upper Ball Joint
(Ø18)



FO1724
Upper Control Arm
(Short-L=226)

FO2144
Lower Control Arm Bush

FO1725
Upper Control Arm
(Short-L=226)

FO1930
Lower Ball Joint
(Ø26.1)



FO1930
Lower Ball Joint
(Ø26.1)



FO2064
Lower Control Arm

FO2065
Lower Control Arm

FO2135
Lower Control Arm Bush

LEFT

RIGHT

FORD

RANGER

FRONT

T8

Year

2018-

FO1047
Outer Tie Rod End
(Ø14.3*Ø17.5/M14*1.5)



FO1333
Outer Tie Rod End Set
(Ø14.3*Ø17.5/M14*1.5)



FO1437
Rack End
(16*1.5/14*1.5/203)



FO1048
Outer Tie Rod End
(Ø14.3*Ø17.5/M14*1.5)



FO1544
Link Stabilizer
L=299



FO1610
Upper Ball Joint
(Ø14.5)



FO1724
Upper Control Arm
(L=240)

FO1812
Upper Control Arm Bush



FO1725
Upper Control Arm
(L=240)

FO1610
Upper Ball Joint
(Ø14.5)



FO1930
Lower Ball Joint
(Ø26.1)

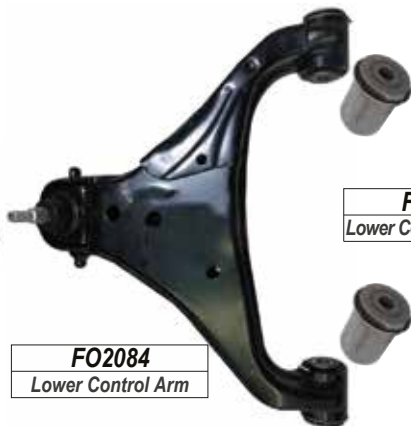

FO2084
Lower Control Arm

FO2146
Lower Control Arm Bush



FO2085
Lower Control Arm

FO1930
Lower Ball Joint
(Ø26.1)



LEFT

RIGHT

FORD

SIERRA.SAPPHIRE FRONT

ALL MODELS

Year

1983-1993

FO1033
Outer Tie Rod End
(Ø12.6*Ø14.6/M14*2)

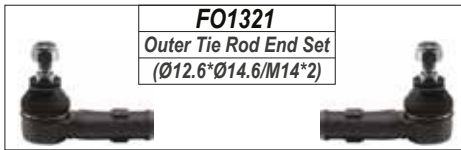

FO1321
Outer Tie Rod End Set
(Ø12.6*Ø14.6/M14*2)

FO1034
Outer Tie Rod End
(Ø12.6*Ø14.6/M14*2)

FO1416
Rack End
(14*1.5/14*2.0/276)



FO2136
Lower Control Arm Bush



FO2111
Lower Control Arm Bush

FO2136
Lower Control Arm Bush

FO2066
Lower Control Arm

FO2067
Lower Control Arm

LEFT

RIGHT

FORD

SPECTRON

FRONT

2.2 BUS.P/VAN

Year

1991-2002

FO1019
Outer Tie Rod End
(Ø14*Ø16/M14*1.5)

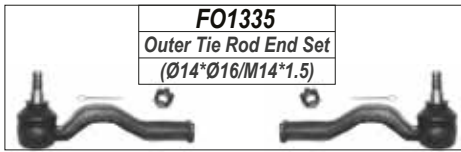

FO1335
Outer Tie Rod End Set
(Ø14*Ø16/M14*1.5)

FO1019
Outer Tie Rod End
(Ø14*Ø16/M14*1.5)



FO1417
Rack End
(17*1.0/14*1.5/182)

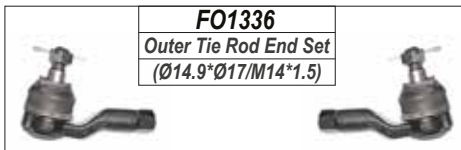

FO1336
Outer Tie Rod End Set
(Ø14.9*Ø17/M14*1.5)

FO1020
Outer Tie Rod End
(Ø14.9*Ø17/M14*1.5)



FO1020
Outer Tie Rod End
(Ø14.9*Ø17/M14*1.5)



FO1612
Upper Ball Joint
(Ø17.85)



FO1612
Upper Ball Joint
(Ø17.85)

FO1718
Upper Control Arm

FO1719
Upper Control Arm

FO1931
Lower Ball Joint
(Ø19.75)



FO1931
Lower Ball Joint
(Ø19.75)

FO2068
Lower Control Arm

FO2069
Lower Control Arm

LEFT

RIGHT

FORD

TELSTAR

FRONT

ALL MODELS

Year

1993-1998

FO1021
Outer Tie Rod End
(Ø12.85*Ø15.05/M14*1.5)

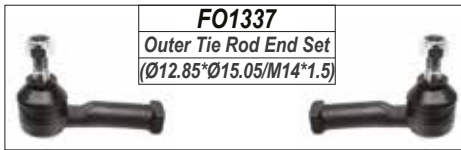

FO1337
Outer Tie Rod End Set
(Ø12.85*Ø15.05/M14*1.5)

FO1418
Rack End
(18*1.5/14*1.5/307)

FO1021
Outer Tie Rod End
(Ø12.85*Ø15.05/M14*1.5)



FO1537 / FO1538
Link Stabilizer
L=104.5



FO1932
Lower Ball Joint
(Ø18)



FO2070
Lower Control Arm

FO2071
Lower Control Arm

FO1932
Lower Ball Joint
(Ø18)

FO2137 / FO2138
Lower Control Arm Bush



TELSTAR

REAR

FO1539
Link Stabilizer
L=88



MA2815
Shock Mounting



MA2816
Shock Mounting



LEFT

RIGHT

FORD

TERRITORY

FRONT

ALL MODELS

Year

2005-

FO1022
Outer Tie Rod End
(Ø14.15*Ø15.9/M16*1.5)

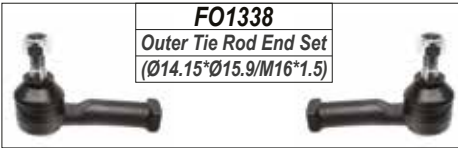

FO1338
Outer Tie Rod End Set
(Ø14.15*Ø15.9/M16*1.5)

FO1023
Outer Tie Rod End
(Ø14.15*Ø15.9/M16*1.5)



FO1419
Rack End
(16*1.5/16*1.5/308)



FO1540
Link Stabilizer
L=317



FO1613
Upper Ball Joint
(Ø18)



FO1813
Upper Control Arm Bush

FO1613
Upper Ball Joint
(Ø18)



FO1720
Upper Control Arm

FO1721
Upper Control Arm

FO1933
Lower Ball Joint
(Ø17.3)



FO2072
Lower Control Arm

FO2073
Lower Control Arm

FO1933
Lower Ball Joint
(Ø17.3)



FO2139
Lower Control Arm Bush



FO2074
Lower Control Arm



FO2075
Lower Control Arm

LEFT

RIGHT

FORD

TOURNEO/TRANSIT CONNECT FRONT

ALL MODELS

Year

2015-

FO1043
Outer Tie Rod End
(Ø12.35*Ø16.1/M16*1.5)

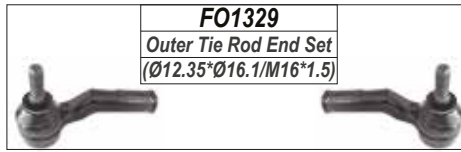

FO1329
Outer Tie Rod End Set
(Ø12.35*Ø16.1/M16*1.5)

FO1044
Outer Tie Rod End
(Ø12.35*Ø16.1/M16*1.5)



FO1431
Rack End
(14*1.5/16*1.5/290)



FO1522
Link Stabilizer
L=298



FO1934
Lower Ball Joint
(Ø21)



FO2082
Lower Control Arm



FO2083
Lower Control Arm

FO1935
Lower Ball Joint
(Ø21)



LEFT

RIGHT

FORD

TOURNEO/TRANSIT FRONT

Year

ALL MODELS

2013-

FO1024
Outer Tie Rod End
(Ø16.7*Ø20.2/M16*1.5)

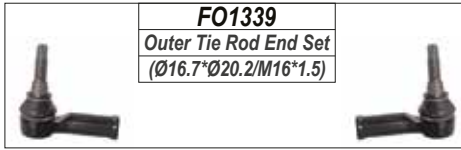

FO1339
Outer Tie Rod End Set
(Ø16.7*Ø20.2/M16*1.5)

FO1420
Rack End
(16*1.5/16*1.5/380)



FO1024
Outer Tie Rod End
(Ø16.7*Ø20.2/M16*1.5)



FO1541
Link Stabilizer
L=290



FO2141
Lower Control Arm Bush

FO1911
Lower Ball Joint
(Ø18.6)



FO2076
Lower Control Arm

FO2077
Lower Control Arm

FO1911
Lower Ball Joint
(Ø18.6)



FO2140
Lower Control Arm Bush



LEFT

RIGHT

FOTON

VIEW

FRONT

2.2

Year

2007-

CA1010
Outer Tie Rod End
(Ø14.6*Ø16.5/M17*1.5)

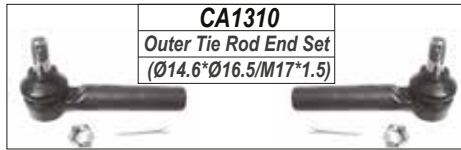

CA1310
Outer Tie Rod End Set
(Ø14.6*Ø16.5/M17*1.5)

CA1410
Rack End
(14*1.5/17*1.5/276)



CA1010
Outer Tie Rod End
(Ø14.6*Ø16.5/M17*1.5)



CA1011
Outer Tie Rod End
(Ø14.7*Ø16/M15*1.5)

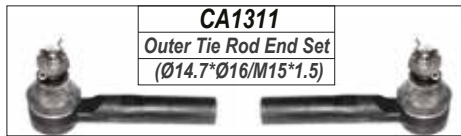

CA1311
Outer Tie Rod End Set
(Ø14.7*Ø16/M15*1.5)

CA1411
Rack End
(14*1.5/15*1.5/274)



CA1011
Outer Tie Rod End
(Ø14.7*Ø16/M15*1.5)



CA1611
Upper Ball Joint
(Ø17.5)



FT1710
Upper Control Arm



FT1711
Upper Control Arm



CA1611
Upper Ball Joint
(Ø17.5)

FT1910
Lower Ball Joint
(Ø16.8)



TO2130
Lower Control Arm Bush



CA2010
Lower Control Arm



CA2011
Lower Control Arm

FT1910
Lower Ball Joint
(Ø16.8)



CA1910
Lower Ball Joint
(Ø18)



CA1910
Lower Ball Joint
(Ø18)



LEFT

RIGHT

FOTON

INKUNZI

FRONT

2.2

Year

2007-

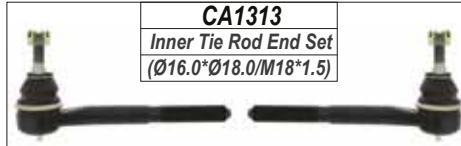
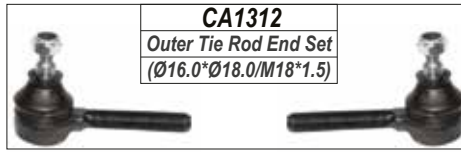

CA1012
<i>Outer Tie Rod End</i>
<i>(Ø16.0*Ø18.0/M18*1.5)</i>



CA1110
<i>Outer Tie Rod End</i>
<i>(Ø16.0*Ø18.0/M18*1.5)</i>



CA1012
<i>Outer Tie Rod End</i>
<i>(Ø16.0*Ø18.0/M18*1.5)</i>



CA1610
<i>Upper Ball Joint</i>
<i>(Ø17)</i>



CA1710
<i>Upper Control Arm</i>

CA1710
<i>Upper Control Arm</i>

CA1610
<i>Upper Ball Joint</i>
<i>(Ø17)</i>



CA1911
<i>Lower Ball Joint</i>
<i>(Ø18)</i>



CA2012
<i>Lower Control Arm</i>

CA2013
<i>Lower Control Arm</i>

CA1911
<i>Lower Ball Joint</i>
<i>(Ø18)</i>



CA2110
<i>Lower Control Arm Bush</i>



LEFT

RIGHT

FOTON

THUNDA

FRONT

2.8

Year

2010-

FT1010
Outer Tie Rod End
(Ø16.1*Ø18/M14*1.5)

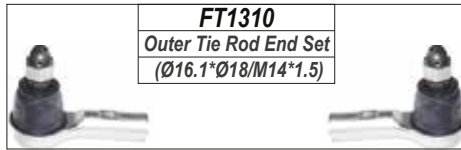

FT1310
Outer Tie Rod End Set
(Ø16.1*Ø18/M14*1.5)

FT1410
Rack End
(14*1.5/14*1.5/296)



FT1010
Outer Tie Rod End
(Ø16.1*Ø18/M14*1.5)



FT1510 / FT1511
Link Stabilizer
L=155



FT1610
Upper Ball Joint
(Ø17.56)



FT1712
Upper Control Arm

FT1713
Upper Control Arm

FT1610
Upper Ball Joint
(Ø17.56)



FT1611
Upper Ball Joint
(Ø17.6)



FT1714
Upper Control Arm

FT1715
Upper Control Arm

FT1611
Upper Ball Joint
(Ø17.6)



FT1911
Lower Ball Joint
(Ø20.6)



FT2010
Lower Control Arm

FT2011
Lower Control Arm

FT1911
Lower Ball Joint
(Ø20.6)

LEFT

RIGHT

GONOW

X-SPACE/STEED

FRONT

2.2

Year

2007-

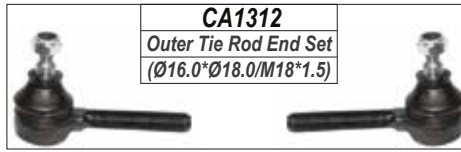

CA1312
Outer Tie Rod End Set
(Ø16.0*Ø18.0/M18*1.5)



CA1313
Inner Tie Rod End Set
(Ø16.0*Ø18.0/M18*1.5)

CA1012
Outer Tie Rod End
(Ø16.0*Ø18.0/M18*1.5)



CA1110
Outer Tie Rod End
(Ø16.0*Ø18.0/M18*1.5)



CA1012
Outer Tie Rod End
(Ø16.0*Ø18.0/M18*1.5)



CA1610
Upper Ball Joint
(Ø17)



CA1710
Upper Control Arm



CA1710
Upper Control Arm

CA1610
Upper Ball Joint
(Ø17)



CA1911
Lower Ball Joint
(Ø18)



CA2012
Lower Control Arm



CA2013
Lower Control Arm

CA1911
Lower Ball Joint
(Ø18)



CA2110
Lower Control Arm Bush

LEFT

RIGHT

GWM

STEED 3,5

FRONT

ALL

Year

2009-

FT1010
Outer Tie Rod End
(Ø16.1*Ø18/M14*1.5)

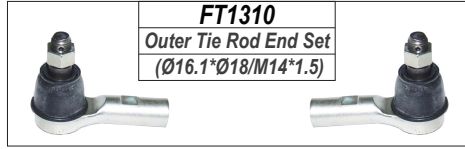

FT1310
Outer Tie Rod End Set
(Ø16.1*Ø18/M14*1.5)

FT1010
Outer Tie Rod End
(Ø16.1*Ø18/M14*1.5)



FT1410
Rack End
(14*1,5/14*1,5/296)



FT1510 / FT1511
Link Stabilizer
L=155

FT1610
Upper Ball Joint
(Ø17.56)



FT1712
Upper Control Arm

FT1713
Upper Control Arm

FT1610
Upper Ball Joint
(Ø17.56)



FT1611
Upper Ball Joint
(Ø17.6)



FT1714
Upper Control Arm

FT1715
Upper Control Arm

FT1611
Upper Ball Joint
(Ø17.6)



FT1911
Lower Ball Joint
(Ø17.6)

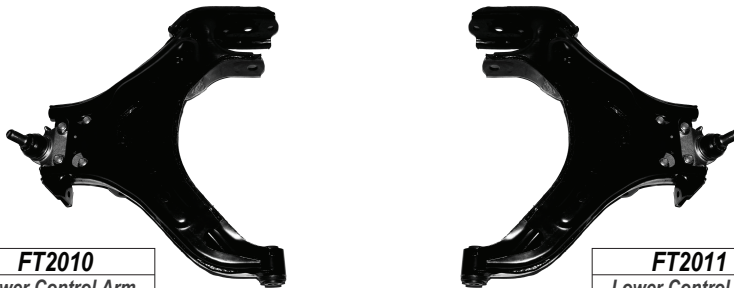

FT2010
Lower Control Arm

FT2011
Lower Control Arm

FT1911
Lower Ball Joint
(Ø17.6)



IS2014
Lower Control Arm
STD-BODY

IS2015
Lower Control Arm
STD-BODY

LEFT **RIGHT**

HONDA

ACCORD

FRONT

VII

Year

2003-2008

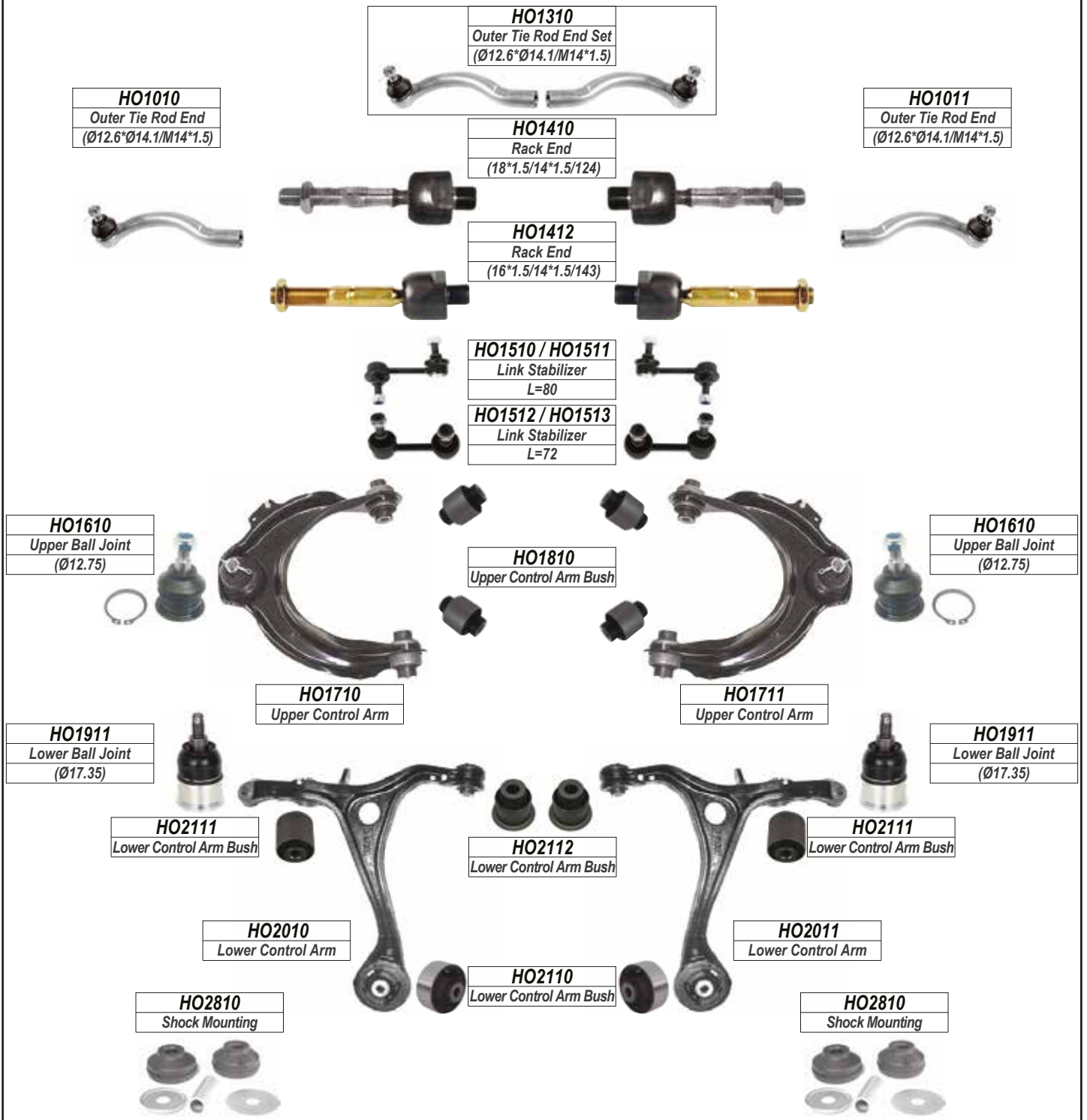

ACCORD

REAR

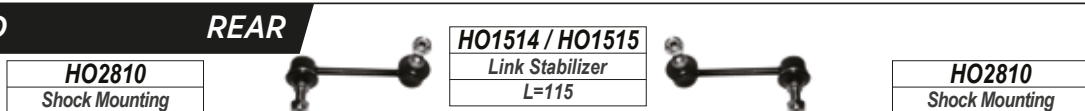

LEFT

RIGHT

HONDA

ACCORD

FRONT

VIII

Year

2008-2014

HO1311
Outer Tie Rod End Set
(Ø13.6*Ø15.1/M14*1.5)

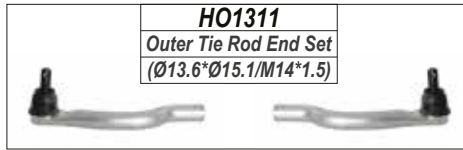

HO1026
Outer Tie Rod End
(Ø13.6*Ø15.1/M14*1.5)



HO1413
Rack End
(18*1.5/14*1.5/131)



HO1027
Outer Tie Rod End
(Ø13.6*Ø15.1/M14*1.5)



HO1510 / HO1511
Link Stabilizer
L=80



HO1516 / HO1517
Link Stabilizer
L=81



HO1611
Upper Ball Joint
(Ø12.48)

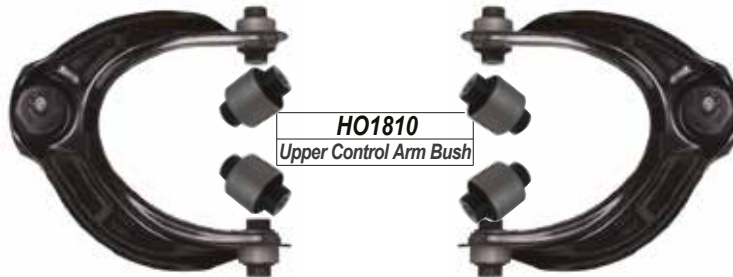

HO1810
Upper Control Arm Bush

HO1611
Upper Ball Joint
(Ø12.48)



HO1712
Upper Control Arm

HO1713
Upper Control Arm

HO1912
Lower Ball Joint
(Ø19.24)



HO2112
Lower Control Arm Bush

HO1912
Lower Ball Joint
(Ø19.24)



HO2012
Lower Control Arm

HO2013
Lower Control Arm

ACCORD

REAR

HO1518 / HO1519
Link Stabilizer
L=145



LEFT

RIGHT

HONDA

BALLADE

FRONT

(FLIP-UP LIGHT).PRELUDE

Year

1984-1989

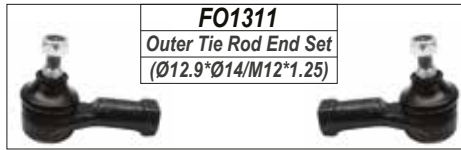

F01026
Outer Tie Rod End
(Ø12.9*Ø14/M12*1.25)

HO1414
Rack End
(12*1.25/12*1.25/276)

F01026
Outer Tie Rod End
(Ø12.9*Ø14/M12*1.25)



HO2016
Lower Control Arm



HO2017
Lower Control Arm

LEFT

RIGHT

HONDA

BALLADE

FRONT

SH4

Year

1989-1992

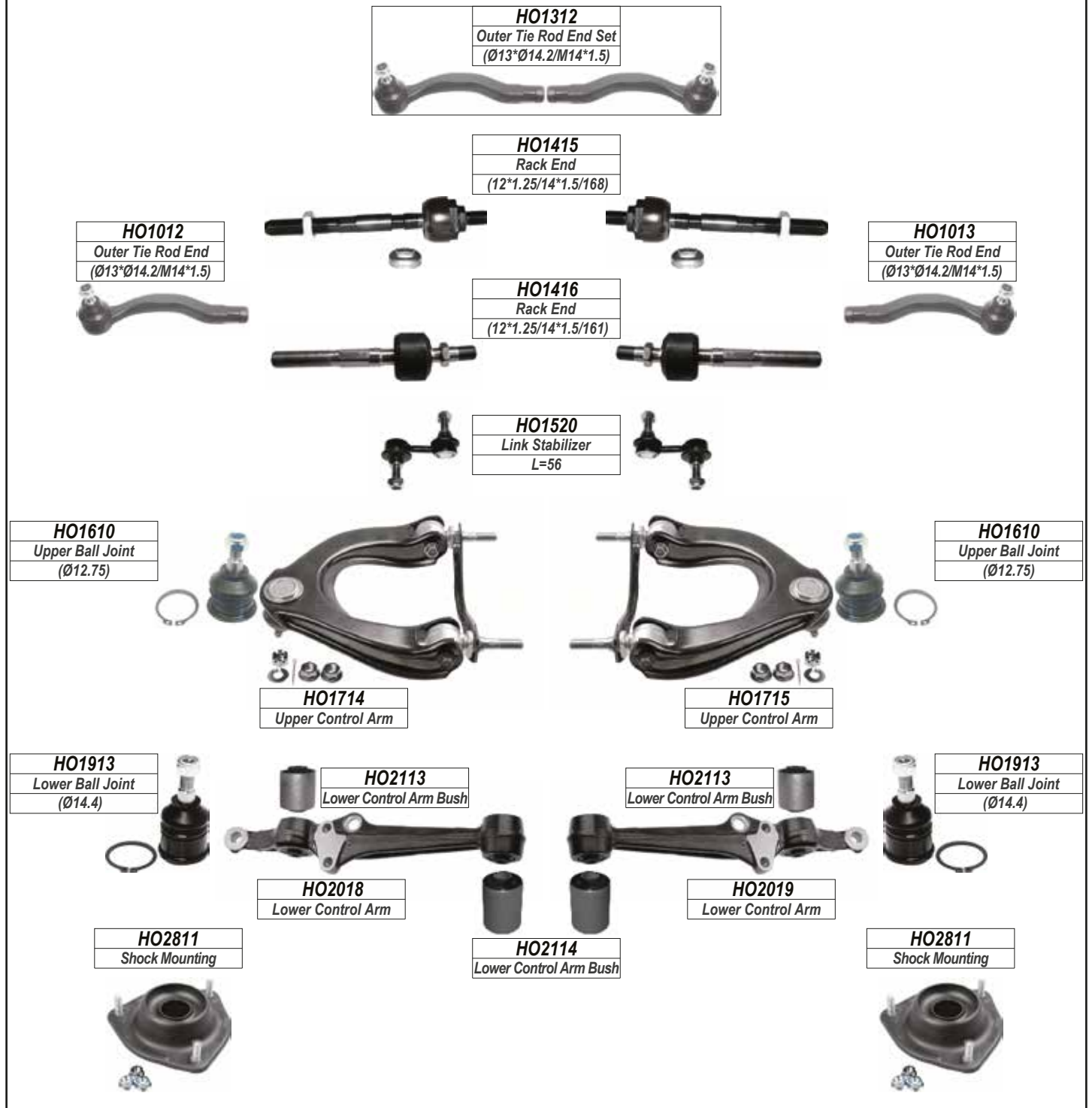

BALLADE

REAR

HO1521 / HO1522
Link Stabilizer
L=83



LEFT

RIGHT

HONDA

BALLADE

FRONT

SR4.S04

Year

1992-2000

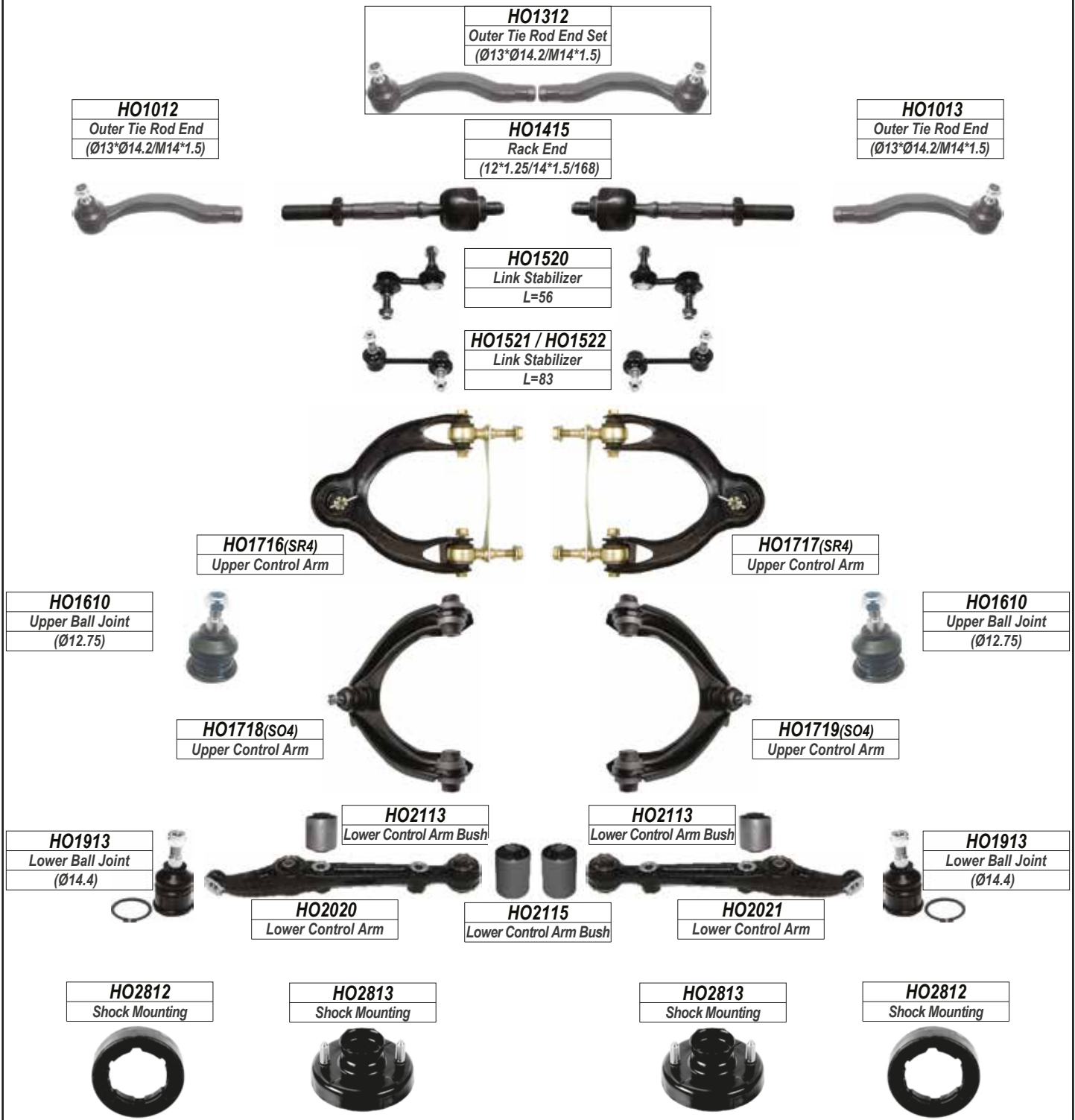

BALLADE

REAR

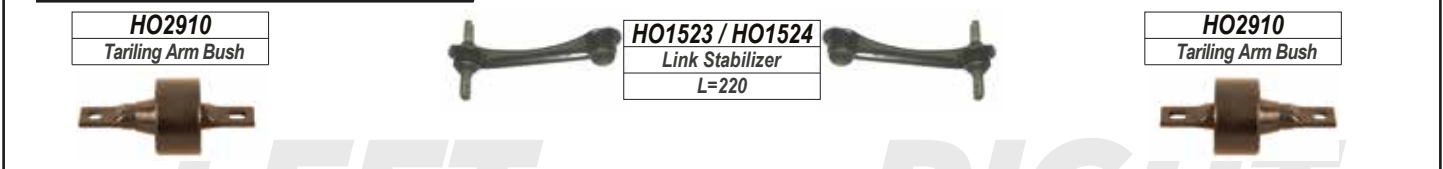

LEFT

RIGHT

HONDA

BALLADE

FRONT

ALL MODELS

Year

2011-

HO1313
Outer Tie Rod End Set
(Ø12.7*Ø14/M14*1.5)

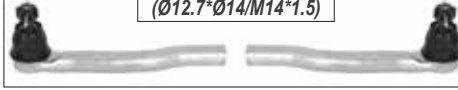

HO1028
Outer Tie Rod End
(Ø12.7*Ø14/M14*1.5)



HO1418
Rack End
(18*1.5/14*1.5/235)



HO1029
Outer Tie Rod End
(Ø12.7*Ø14/M14*1.5)



HO1525
Link Stabilizer
L=324.5



HO1914
Lower Ball Joint
(Ø17.5)



HO2022
Lower Control Arm

HO2023
Lower Control Arm

HO1914
Lower Ball Joint
(Ø17.5)



HO2814
Shock Mounting



HO2814
Shock Mounting



LEFT

RIGHT

HONDA

BRIO

FRONT

ALL MODELS

Year

2012-

HO1313
Outer Tie Rod End Set
(Ø12.7*Ø14/M14*1.5)

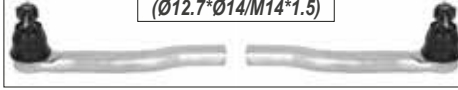

HO1028
Outer Tie Rod End
(Ø12.7*Ø14/M14*1.5)



HO1418
Rack End
(18*1.5/14*1.5/235)



HO1029
Outer Tie Rod End
(Ø12.7*Ø14/M14*1.5)



HO1525
Link Stabilizer
L=324.5



HO1914
Lower Ball Joint
(Ø17.5)



HO2022
Lower Control Arm

HO2023
Lower Control Arm

HO1914
Lower Ball Joint
(Ø17.5)



HO2814
Shock Mounting



HO2814
Shock Mounting



LEFT

RIGHT

HONDA

BRIO AMAZE

FRONT

ALL MODELS

Year

2012-

HO1030
Outer Tie Rod End
(Ø12.5*Ø14.1/M12*1.25)

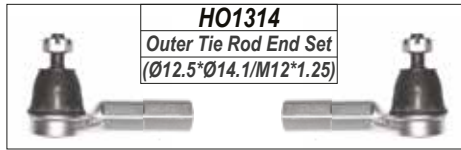

HO1431
Rack End
(14*1.5/12*1.25/310)

HO1030
Outer Tie Rod End
(Ø12.5*Ø14.1/M12*1.25)



HO1419
Rack End
(14*1.25/12*1.25/307)



HO1525
Link Stabilizer
L=324.5



HO1915
Lower Ball Joint
(Ø16)



HO2134
Lower Control Arm Bush



HO1915
Lower Ball Joint
(Ø16)



HO2024
Lower Control Arm

HO2025
Lower Control Arm

HO2814
Shock Mounting



HO2814
Shock Mounting



HO2135
Lower Control Arm Bush



LEFT

RIGHT

HONDA		Year
BRIO AMAZE FRONT	DF5	2018-



HO1040
Outer Tie Rod End
(?)



HO1439
Rack End
(18*1.5/14*1.5/240)

Photo
Unavailable

HO1040
Outer Tie Rod End
(?)



HO1565
Link Stabilizer
L=310

Photo
Unavailable

HO1926
Lower Ball Joint
(Ø?)

Photo
Unavailable

HO2145
Lower Control Arm Bush

Photo
Unavailable

HO1926
Lower Ball Joint
(Ø?)

Photo
Unavailable

HO2062
Lower Control Arm

Photo
Unavailable

HO2063
Lower Control Arm

Photo
Unavailable

Photo
Unavailable

HO2146
Lower Control Arm Bush

LEFT

RIGHT

HONDA

BR-V

FRONT

ALL MODELS

Year

2016-

HO1028
Outer Tie Rod End
(Ø12.7*Ø14/M14*1.5)

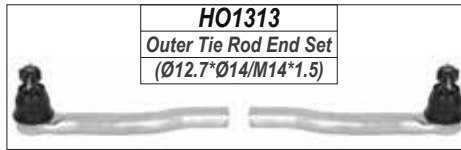

HO1313
Outer Tie Rod End Set
(Ø12.7*Ø14/M14*1.5)

HO1439
Rack End
(18*1.5/14*1.5/240)

Photo
Unavailable

HO1029
Outer Tie Rod End
(Ø12.7*Ø14/M14*1.5)



HO1558
Link Stabilizer
L=?

Photo
Unavailable

HO1926
Lower Ball Joint
(Ø?)

Photo
Unavailable

HO2136
Lower Control Arm Bush

Photo
Unavailable

HO1926
Lower Ball Joint
(Ø?)

Photo
Unavailable

HO2050
Lower Control Arm

Photo
Unavailable

HO2051
Lower Control Arm

Photo
Unavailable

Photo
Unavailable

HO2136
Lower Control Arm Bush

LEFT

RIGHT

HONDA

CIVIC

FRONT

Year

MK VI (EJ9,EK3,EK4,MA8,MA9,MB1,MB2,MB3,MB4)

1996-2001

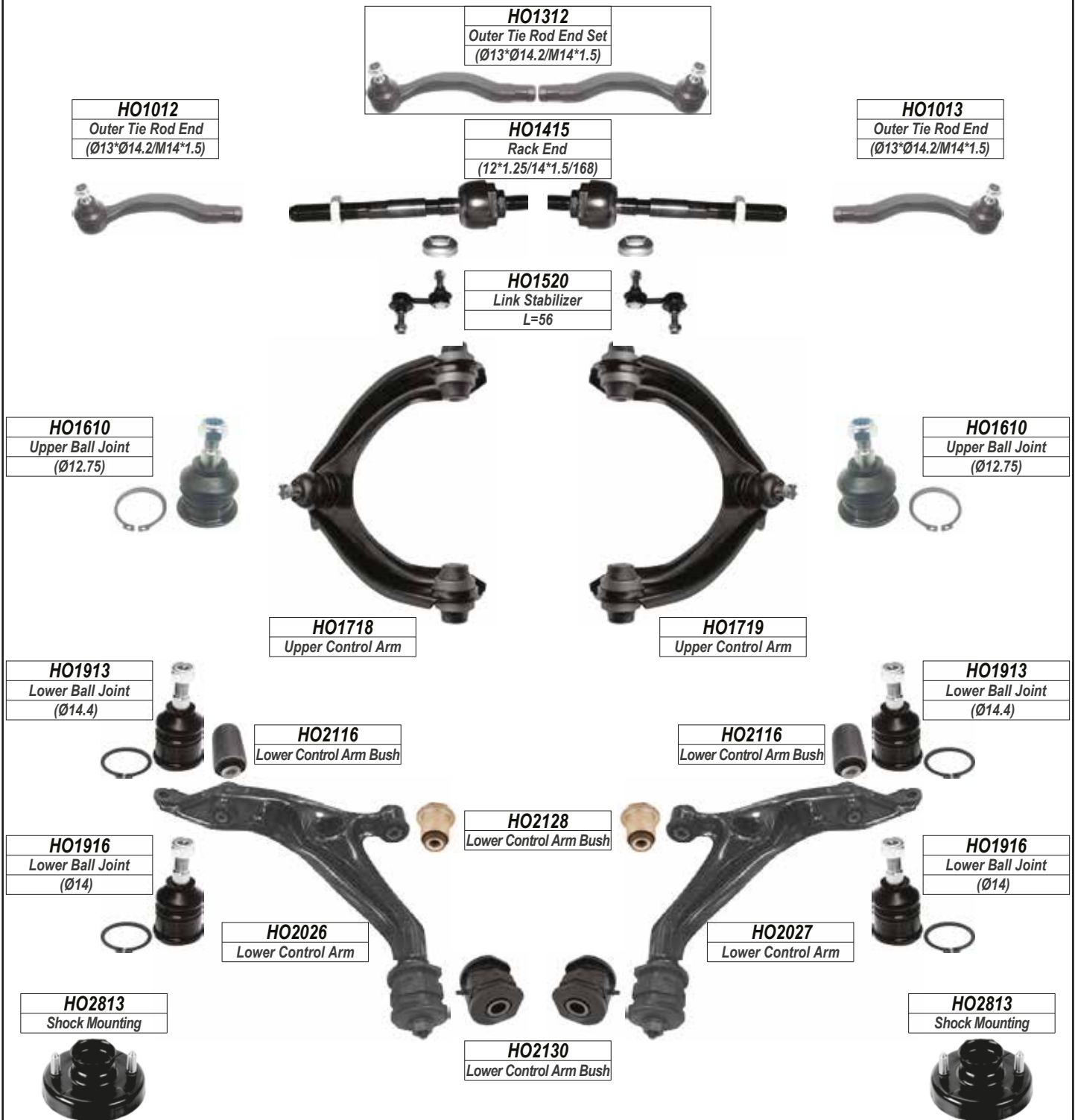

CIVIC

REAR

HO1521 / HO1522
Link Stabilizer
L=83

HO2910
Trailing Arm Bush

HO2910
Trailing Arm Bush

HO1523 / HO1524
Link Stabilizer
L=220

HO1523 / HO1524
Link Stabilizer
L=220

LEFT

RIGHT

HONDA

CIVIC

FRONT

MK VII (EP2,ES1,ES5,ES8,EU3,EU6,EU8)

Year

2001-2005

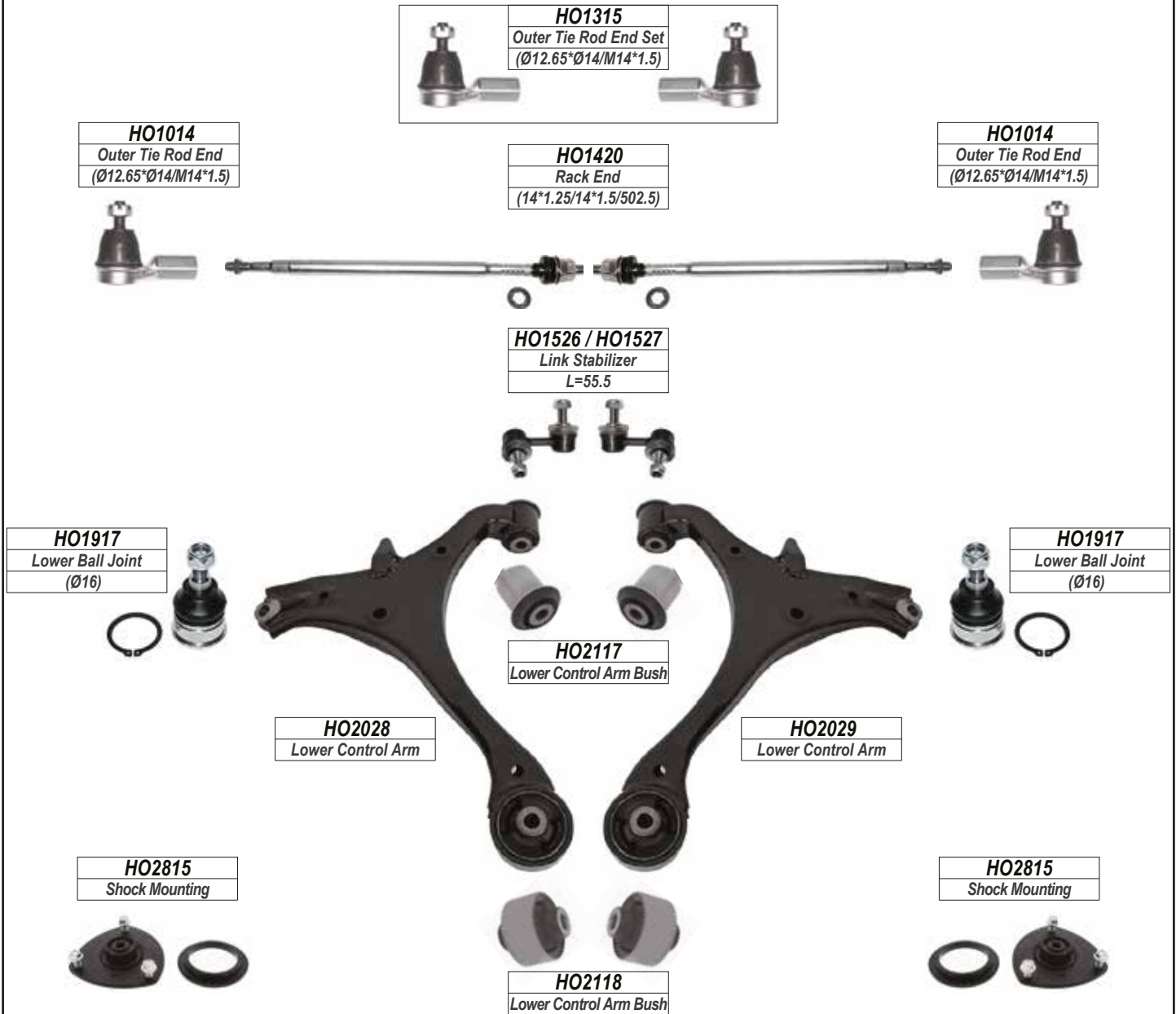

CIVIC

REAR

HO1528 / HO1529
Link Stabilizer
L=72.5

HO2816
Shock Mounting



HO2816
Shock Mounting

LEFT

RIGHT

HONDA

CIVIC

FRONT

MK VIII (FD1,FD7,FK2,FK3,FK4,FN2)

Year

2005-2012

HO1015
Outer Tie Rod End
(Ø13.73*Ø15.1/M14*1.5)

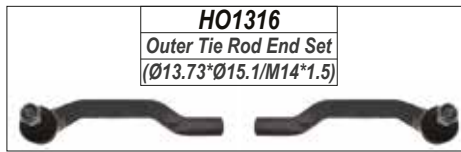

HO1316
Outer Tie Rod End Set
(Ø13.73*Ø15.1/M14*1.5)

HO1016
Outer Tie Rod End
(Ø13.73*Ø15.1/M14*1.5)

HO1421
Rack End
(20*1.5/14*1.5/174)



HO1422
Rack End
(20*1.5/14*1.5/208)



HO1424
Rack End
(18*1.5/14*1.5/175)



HO1530
Link Stabilizer
L=225.5



HO1531 / HO1532
Link Stabilizer
L=71



HO1918
Lower Ball Joint
(Ø17.4)



HO2032
Lower Control Arm

HO2033
Lower Control Arm

HO1919
Lower Ball Joint
(Ø17.4)



HO2030
Lower Control Arm



HO2031
Lower Control Arm

HO2820
Shock Mounting



HO2820
Shock Mounting



HO2119
Lower Control Arm Bush



CIVIC

REAR

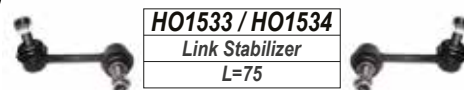

HO1533 / HO1534
Link Stabilizer
L=75

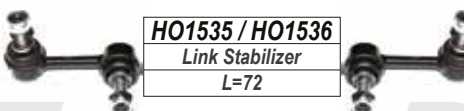

HO1535 / HO1536
Link Stabilizer
L=72

LEFT

RIGHT

HONDA

CIVIC

FRONT

MK IX (FB1,FB2,FK1,FK2,FK3)

Year

2012-

HO1317
Outer Tie Rod End Set
(Ø13.6*Ø15/M14*1.5)



HO1017
Outer Tie Rod End
(Ø13.6*Ø15/M14*1.5)



HO1425
Rack End
(20*1.5/14*1.5/189)



HO1018
Outer Tie Rod End
(Ø13.6*Ø15/M14*1.5)



HO1537 / HO1538
Link Stabilizer
L=325



HO2121
Lower Control Arm Bush



HO1920
Lower Ball Joint
(Ø15.5)



HO2034
Lower Control Arm

HO2035
Lower Control Arm

HO1920
Lower Ball Joint
(Ø15.5)



HO2120
Lower Control Arm Bush



HO2820
Shock Mounting



HO2820
Shock Mounting



LEFT

RIGHT

HONDA

CIVIC

FRONT

MK X (FC1,FC5,FC6,FK7,FK8)

Year

2016-

HO1034
Outer Tie Rod End
(Ø14.2*Ø16/M14*1.5)

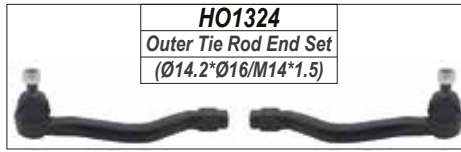

HO1324
Outer Tie Rod End Set
(Ø14.2*Ø16/M14*1.5)

HO1440
Rack End
(18*1.5/14*1.5/212.5)

HO1035
Outer Tie Rod End
(Ø14.2*Ø16/M14*1.5)



HO1559
Link Stabilizer
L=56



HO1560
Link Stabilizer
L=56



HO1927
Lower Ball Joint
(Ø13.8)



HO2139
Lower Control Arm Bush



HO1927
Lower Ball Joint
(Ø13.8)



HO2052
Lower Control Arm



HO2053
Lower Control Arm



HO2138
Lower Control Arm Bush



LEFT

RIGHT

HONDA

CR-V

FRONT

MK I (RD1,RD3)

Year

1997-2002

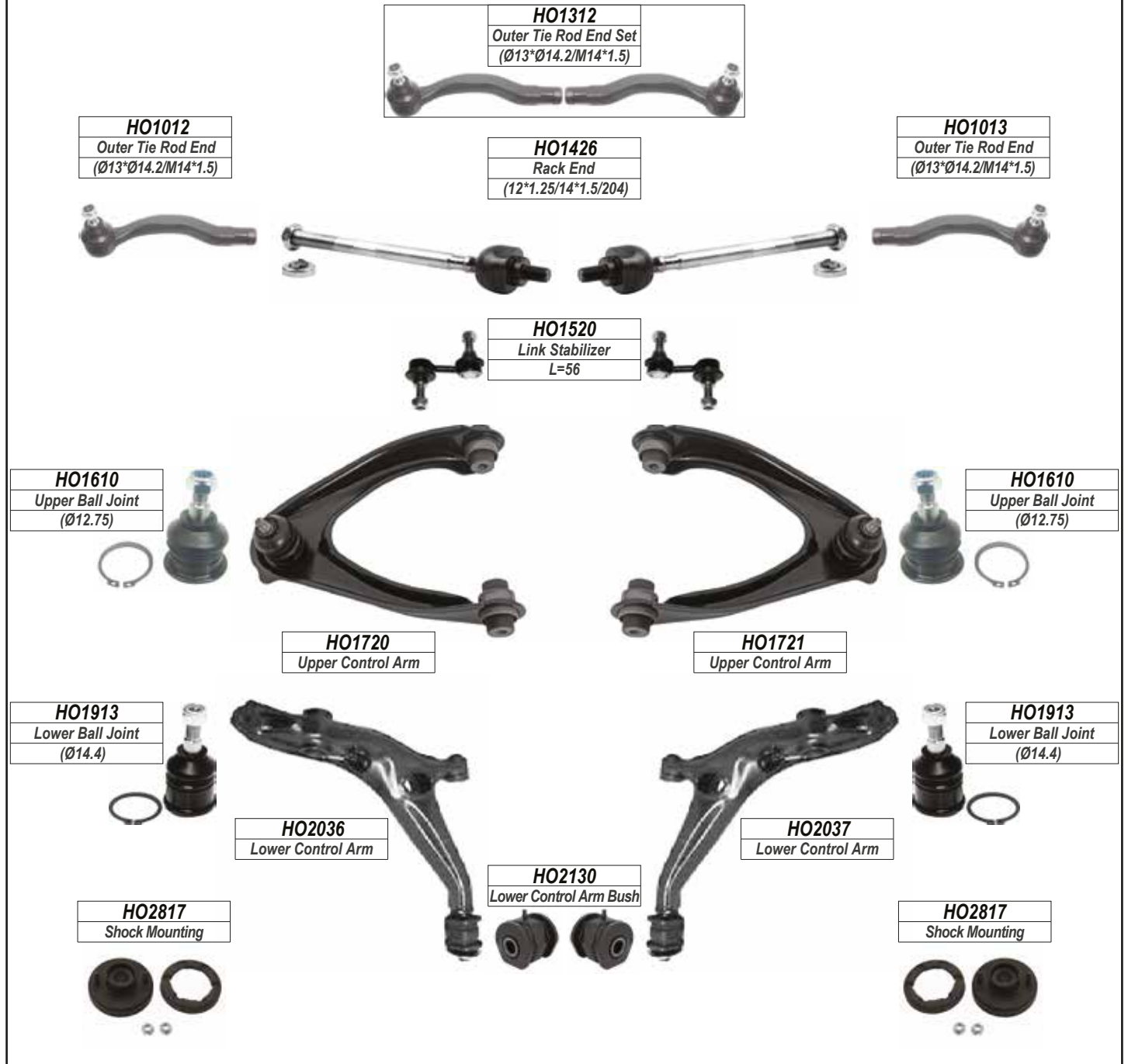

CRV REAR



LEFT

RIGHT

HONDA

CR-V

FRONT

MK II (RD5,RD8)

Year

2002-2007

HO1014
Outer Tie Rod End
(Ø12.65*Ø14/M14*1.5)

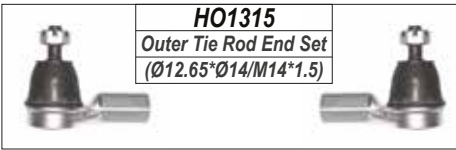

HO1315
Outer Tie Rod End Set
(Ø12.65*Ø14/M14*1.5)

HO1427
Rack End
(14*1.25/14*1.5/545)

HO1014
Outer Tie Rod End
(Ø12.65*Ø14/M14*1.5)



HO1526 / HO1527
Link Stabilizer
L=55.5



HO1610
Upper Ball Joint
(Ø12.75)



HO1610
Upper Ball Joint
(Ø12.75)



HO1921
Lower Ball Joint
(Ø15.5)



HO1921
Lower Ball Joint
(Ø15.5)

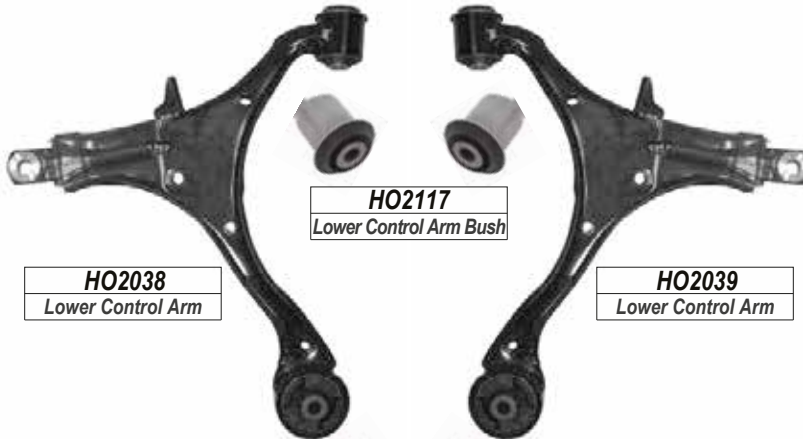

HO2117
Lower Control Arm Bush

HO2038
Lower Control Arm

HO2039
Lower Control Arm

HO2815
Shock Mounting



HO2815
Shock Mounting



HO2129
Lower Control Arm Bush



CRV

REAR

HO2816
Shock Mounting



HO1541 / HO1542
Link Stabilizer
L=89



HO2816
Shock Mounting



LEFT

RIGHT

HONDA

CR-V

FRONT

MK III (RE5,RE6,RE7)

Year

2007-2012

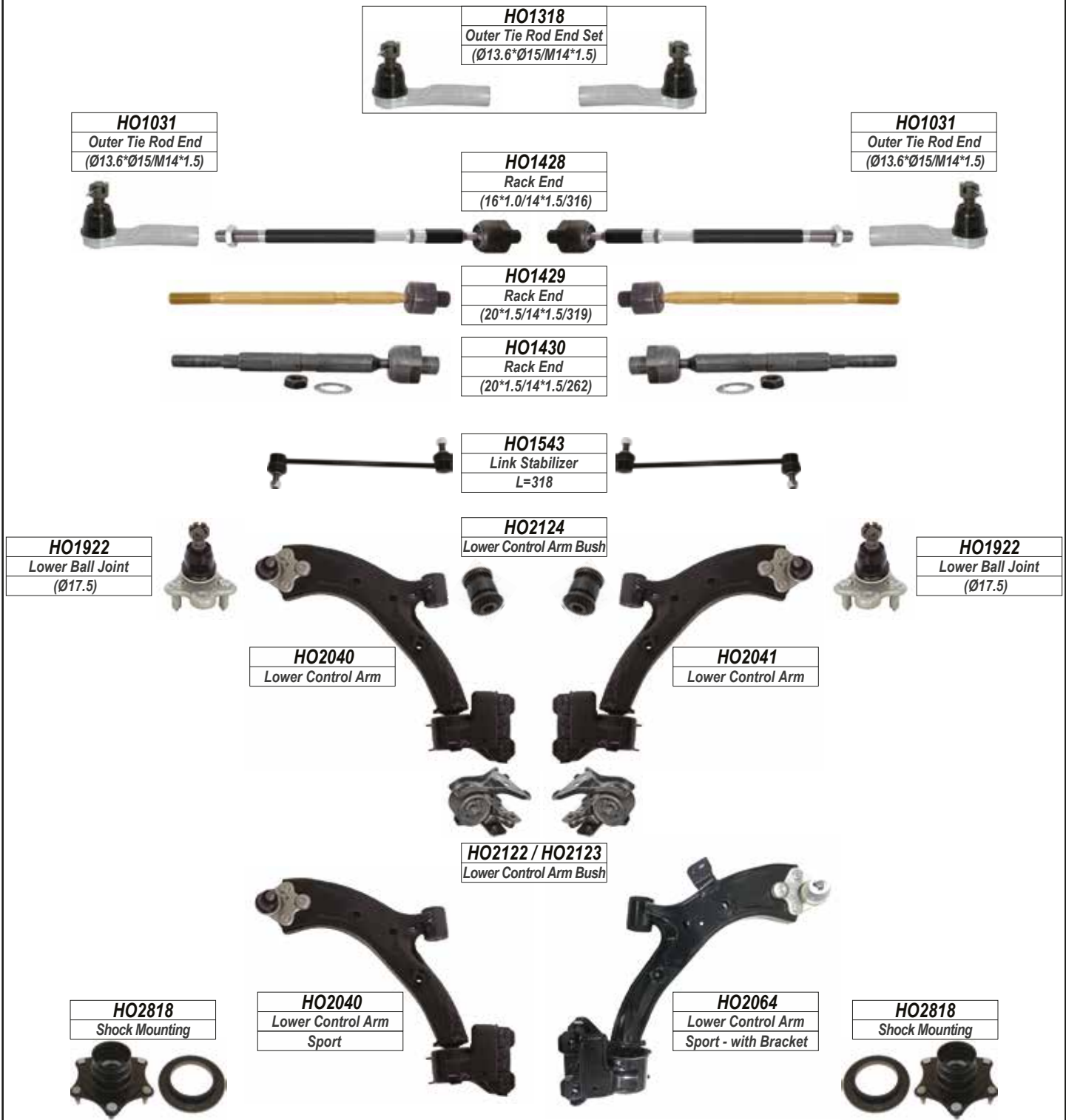

CRV

REAR



HONDA

CR-V

FRONT

MK IV (RE5,RE6,RM4)

Year

2012-2017

HO1019
Outer Tie Rod End
(Ø13.6*Ø15/M14*1.5)



HO1319
Outer Tie Rod End Set
(Ø13.6*Ø15/M14*1.5)

HO1411
Rack End
(16*1.0/14*1.5/225)



HO1020
Outer Tie Rod End
(Ø13.6*Ø15/M14*1.5)



HO1543
Link Stabilizer
L=318



HO2140
Lower Control Arm Bush



HO1922
Lower Ball Joint
(Ø17.5)



HO1922
Lower Ball Joint
(Ø17.5)



HO2042
Lower Control Arm



HO2043
Lower Control Arm



HO2141 / HO2142
Lower Control Arm Bush



CR-V

REAR

HO1544 / HO1545
Link Stabilizer
L=85



LEFT

RIGHT

HONDA

CR-V

FRONT

MK V (RW2,RW3)

Year

2017-

HO1325
Outer Tie Rod End Set
(Ø14.2*Ø16/M14*1.50)

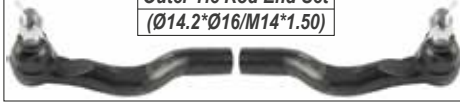

HO1036
Outer Tie Rod End
(Ø14.2*Ø16/M14*1.50)

HO1441
Rack End
(18*1.5/14*1.50/303)

HO1037
Outer Tie Rod End
(Ø14.2*Ø16/M14*1.50)



HO1561
Link Stabilizer
L=346



HO1562
Link Stabilizer
L=346



HO1928
Lower Ball Joint
(Ø15.5)



HO1928
Lower Ball Joint
(Ø15.5)



HO2054
Lower Control Arm



HO2143 / HO2144
Lower Control Arm Bush



LEFT

RIGHT

HONDA

CR-Z

FRONT

ZF1

Year

2010-

HO1031
Outer Tie Rod End
(Ø13.6*Ø15/M14*1.5)

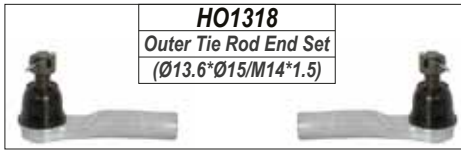

HO1318
Outer Tie Rod End Set
(Ø13.6*Ø15/M14*1.5)

HO1442
Rack End
(16*1.0/14*1.5/341)



HO1031
Outer Tie Rod End
(Ø13.6*Ø15/M14*1.5)



HO1525
Link Stabilizer
L=324.5



HO1914
Lower Ball Joint
(Ø17.5)



HO2056
Lower Control Arm

HO2057
Lower Control Arm

HO1914
Lower Ball Joint
(Ø17.5)



LEFT

RIGHT

HONDA

HR-V

FRONT

GH2, GH4

Year

2002-2005

HO1021
Outer Tie Rod End
(Ø13.75*Ø15.5/M12*1.25)

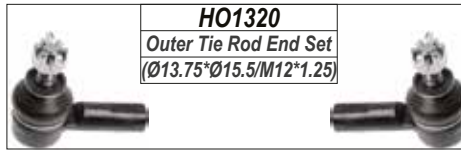

HO1320
Outer Tie Rod End Set
(Ø13.75*Ø15.5/M12*1.25)

HO1431
Rack End
(14*1.5/12*1.25/310)

HO1021
Outer Tie Rod End
(Ø13.75*Ø15.5/M12*1.25)



HO1546 / HO1547
Link Stabilizer
L=150



HO1910
Lower Ball Joint
(Ø14.1)



HO2058
Lower Control Arm

HO2059
Lower Control Arm

HO1910
Lower Ball Joint
(Ø14.1)



HR-V

REAR

HO1548 / HO1549
Link Stabilizer
L=150



LEFT

RIGHT

HONDA

HR-V

FRONT

RU1,RU5

Year

2014-

HO1038
Outer Tie Rod End
(Ø14*Ø16.5/M14*1.5)



HO1326
Outer Tie Rod End Set
(Ø14*Ø16.5/M14*1.5)

HO1443
Rack End
(14*1.5/14*1.5/289.5)

HO1039
Outer Tie Rod End
(Ø14*Ø16.5/M14*1.5)



HO1563/HO1564
Link Stabilizer
L=340



HO1922
Lower Ball Joint
(Ø17.5)



HO1922
Lower Ball Joint
(Ø17.5)



HO2060
Lower Control Arm



HO2061
Lower Control Arm



LEFT

RIGHT

HONDA

INSIGHT

FRONT

1.3.1.3HYBIRD

Year

2009-2014

HO1313

Outer Tie Rod End Set
(Ø12.7*Ø14/M14*1.5)

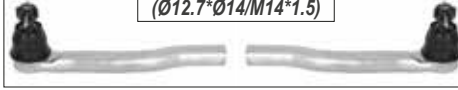

HO1028

Outer Tie Rod End
(Ø12.7*Ø14/M14*1.5)



HO1418

Rack End
(18*1.5/14*1.5/235)



HO1029

Outer Tie Rod End
(Ø12.7*Ø14/M14*1.5)



HO1525

Link Stabilizer
L=324.5



HO2127

Lower Control Arm Bush

Lower Control Arm Bush

Lower Control Arm Bush

Lower Control Arm Bush

Lower Control Arm Bush

Lower Control Arm Bush

Lower Control Arm Bush

Lower Control Arm Bush

Lower Control Arm Bush

Lower Control Arm Bush

Lower Control Arm Bush

Lower Control Arm Bush

Lower Control Arm Bush

Lower Control Arm Bush

Lower Control Arm Bush

Lower Control Arm Bush

Lower Control Arm Bush

Lower Control Arm Bush

Lower Control Arm Bush

Lower Control Arm Bush

Lower Control Arm Bush

Lower Control Arm Bush

Lower Control Arm Bush

Lower Control Arm Bush

Lower Control Arm Bush

Lower Control Arm Bush

Lower Control Arm Bush

Lower Control Arm Bush

Lower Control Arm Bush

HO1914

Lower Ball Joint
(Ø17.5)



HO2022

Lower Control Arm



HO2023

Lower Control Arm



HO1914

Lower Ball Joint
(Ø17.5)



HO2125 / HO2126

Lower Control Arm Bush

Lower Control Arm Bush

Lower Control Arm Bush

Lower Control Arm Bush

Lower Control Arm Bush

Lower Control Arm Bush

Lower Control Arm Bush

Lower Control Arm Bush

Lower Control Arm Bush

Lower Control Arm Bush

Lower Control Arm Bush

Lower Control Arm Bush

Lower Control Arm Bush

Lower Control Arm Bush

LEFT

RIGHT

HONDA

JAZZ

FRONT

II (GD)

Year

2002-2008

HO1321
Outer Tie Rod End Set
(Ø12.6*Ø14/M12*1.25)

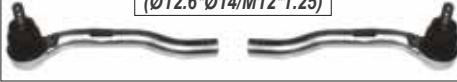

HO1022
Outer Tie Rod End
(Ø12.6*Ø14/M12*1.25)



HO1432
Rack End
(16*1.0/12*1.25/211)



HO1432
Rack End
(16*1.0/12*1.25/212)



HO1023
Outer Tie Rod End
(Ø12.6*Ø14/M12*1.25)



HO1434
Rack End
(18*1.5/12*1.25/211)



HO1435
Rack End
(18*1.5/12*1.25/212)



HO1550 / HO1551
Link Stabilizer
L=300



HO1552 / HO1553
Link Stabilizer
L=320



HO1910
Lower Ball Joint
(Ø16)



HO1910
Lower Ball Joint
(Ø16)



HO2044
Lower Control Arm



HO2045
Lower Control Arm

HO2814
Shock Mounting



HO2814
Shock Mounting



LEFT

RIGHT

HONDA

JAZZ

FRONT

III (GE)

Year

2008-

HO1028
Outer Tie Rod End
(Ø12.7*Ø14/M14*1.5)

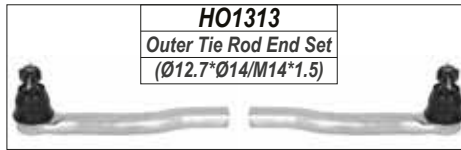

HO1313
Outer Tie Rod End Set
(Ø12.7*Ø14/M14*1.5)

HO1418
Rack End
(18*1.5/14*1.5/235)



HO1029
Outer Tie Rod End
(Ø12.7*Ø14/M14*1.5)



HO1525
Link Stabilizer
L=324.5



HO2127
Lower Control Arm Bush



HO1914
Lower Ball Joint
(Ø17.5)



HO2022
Lower Control Arm

HO2023
Lower Control Arm

HO1914
Lower Ball Joint
(Ø17.5)



HO2125 / HO2126
Lower Control Arm Bush



HO2814
Shock Mounting



HO2814
Shock Mounting



LEFT

RIGHT

HONDA

JAZZ

FRONT

IV (GK)

Year

2014-

HO1032
Outer Tie Rod End
(Ø12.7*Ø14/M14*1.5)



HO1323
Outer Tie Rod End Set
(Ø12.7*Ø14/M14*1.5)

HO1437
Rack End
(14*1.5/14*1.5/271)



HO1033
Outer Tie Rod End
(Ø12.7*Ø14/M14*1.5)



HO1556 / HO1557
Link Stabilizer
L=310



HO2132
Lower Control Arm Bush

HO1925
Lower Ball Joint
(Ø15.5)



HO2048
Lower Control Arm

HO2049
Lower Control Arm

HO1925
Lower Ball Joint
(Ø15.5)



HO2133
Lower Control Arm Bush



LEFT

RIGHT

HONDA

MOBILIO

FRONT

ALL MODEL

Year

2013-

HO1028
Outer Tie Rod End
(Ø12.7*Ø14/M14*1.5)

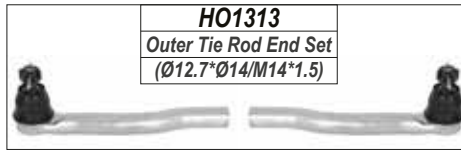

HO1313
Outer Tie Rod End Set
(Ø12.7*Ø14/M14*1.5)

HO1438
Rack End
(14*1.5/14*1.5/235)



HO1029
Outer Tie Rod End
(Ø12.7*Ø14/M14*1.5)



HO1525
Link Stabilizer
L=324.5



HO1924
Lower Ball Joint
(Ø16)



HO2046
Lower Control Arm

HO2047
Lower Control Arm

HO1924
Lower Ball Joint
(Ø16)



LEFT

RIGHT

HONDA

PRELUDE

FRONT

ALL MODEL

Year

1997-2001

HO1322
Outer Tie Rod End Set
(Ø12.5*Ø14/M14*1.5)



HO1024
Outer Tie Rod End
(Ø12.5*Ø14/M14*1.5)



HO1436
Rack End
(14*1.25/14*1.5/141)



HO1025
Outer Tie Rod End
(Ø12.5*Ø14/M14*1.5)



HO1554
Link Stabilizer
L=104



HO1612
Upper Ball Joint
(--)



HO1612
Upper Ball Joint
(--)



HO1923
Lower Ball Joint
(--)



HO1923
Lower Ball Joint
(--)



PRELUDE

REAR

HO1555
Link Stabilizer
L=165



LEFT

RIGHT

HUMMER

H3

FRONT

ALL MODELS

Year

2005-2010

HM1010
Outer Tie Rod End
(Ø14*Ø2/M16*1.5)

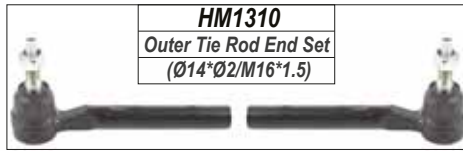

HM1310
Outer Tie Rod End Set
(Ø14*Ø2/M16*1.5)

HM1410
Rack End
(14*1,5/16*1,5/290)



HM1010
Outer Tie Rod End
(Ø14*Ø2/M16*1.5)



HM1710
Upper Control Arm

HM1711
Upper Control Arm

HM1910
Lower Ball Joint
(Ø18)



HM1910
Lower Ball Joint
(Ø18)



H3

REAR

HM1510
Link Stabilizer
L=167



LEFT

RIGHT

HYUNDAI

ACCENT

FRONT

1.3 / 1.5

Year

1994-2000

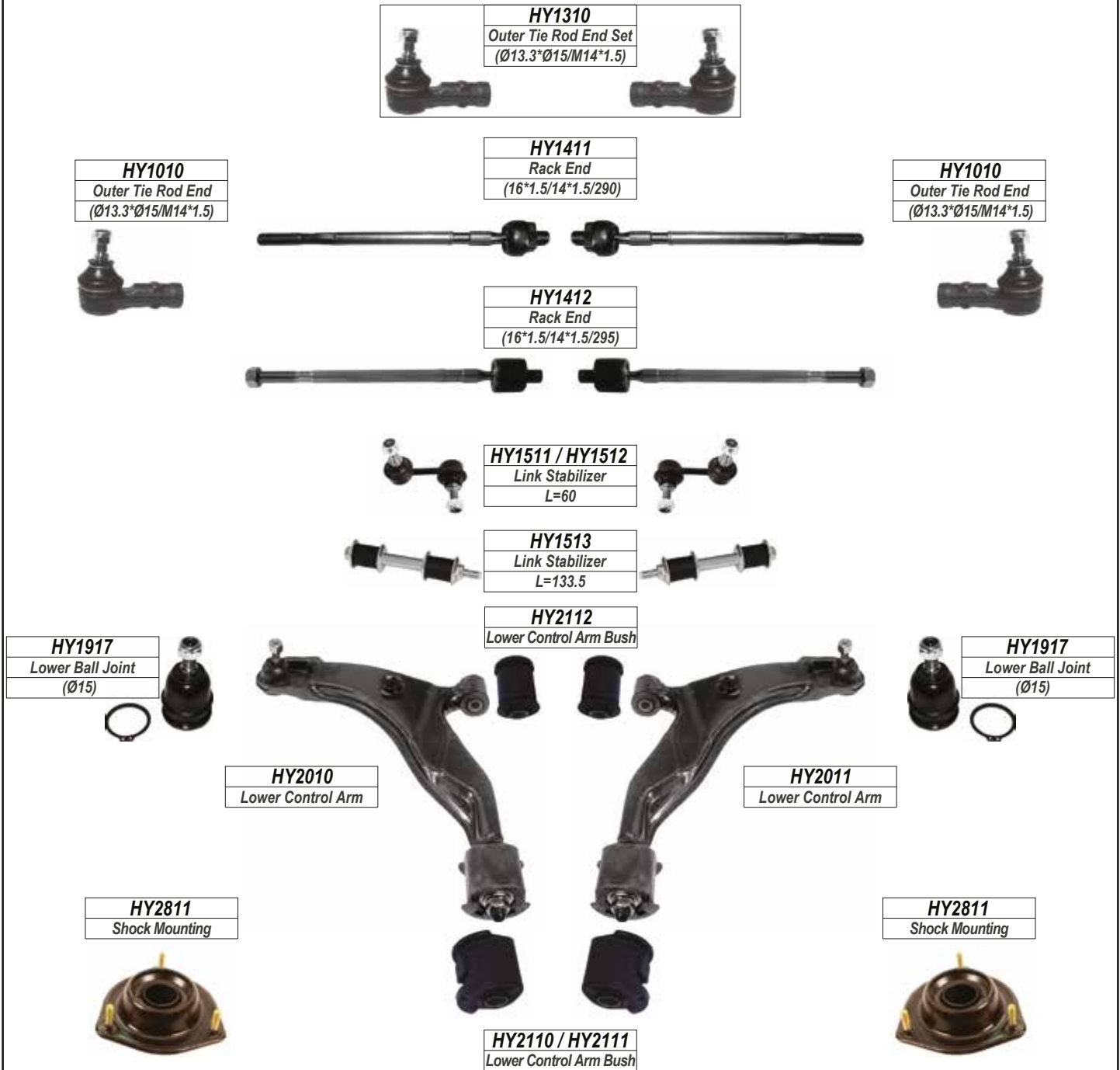

ACCENT

REAR

HY1514
Link Stabilizer
L=137



LEFT

RIGHT

HYUNDAI

ACCENT

FRONT

1.3 / 1.5 / 1.6

Year

2002-2006

HY1010
Outer Tie Rod End
(Ø13.3*Ø15/M14*1.5)

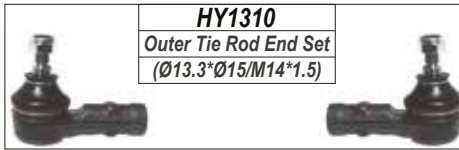

HY1310
Outer Tie Rod End Set
(Ø13.3*Ø15/M14*1.5)

HY1413
Rack End
(16*1.5/14*1.5/303)

HY1010
Outer Tie Rod End
(Ø13.3*Ø15/M14*1.5)



HY1511 / HY1512
Link Stabilizer
L=60



HY1917
Lower Ball Joint
(Ø15)



HY2113
Lower Control Arm Bush



HY1917
Lower Ball Joint
(Ø15)



HY2012
Lower Control Arm



HY2013
Lower Control Arm

HY2811
Shock Mounting



HY2811
Shock Mounting



HY2114
Lower Control Arm Bush



ACCENT

REAR

HY1514
Link Stabilizer
L=137



HY2812
Shock Mounting



HY2812
Shock Mounting



LEFT

RIGHT

HYUNDAI

ACCENT

FRONT

1.4 / 1.6

Year

2006-2011

HY1311
Outer Tie Rod End Set
(Ø13.3*Ø15/M14*1.5)



HY1011
Outer Tie Rod End
(Ø13.3*Ø15/M14*1.5)



HY1414
Rack End
(16*1.5/14*1.5/190)



HY1012
Outer Tie Rod End
(Ø13.3*Ø15/M14*1.5)



HY1515 / HY1516
Link Stabilizer
L=285



HY2116
Lower Control Arm Bush



HY1918
Lower Ball Joint
(Ø15)



HY1918
Lower Ball Joint
(Ø15)



HY2014
Lower Control Arm

HY2015
Lower Control Arm

HY2813
Shock Mounting



HY2115
Lower Control Arm Bush



HY2813
Shock Mounting



HY2819
Shock Mounting



HY2819
Shock Mounting



LEFT

RIGHT

HYUNDAI

ACCENT

FRONT

1.6

Year

2011-

HY1021
Outer Tie Rod End
(Ø13.2*Ø15/M16*1.5)

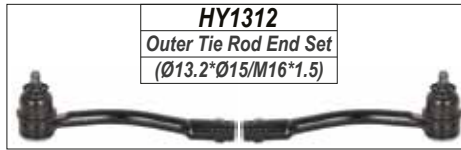

HY1312
Outer Tie Rod End Set
(Ø13.2*Ø15/M16*1.5)

HY1415
Rack End
(16*1.5/16*1.5/217)



HY1022
Outer Tie Rod End
(Ø13.2*Ø15/M16*1.5)



KI1315
Outer Tie Rod End Set
(Ø13.25*Ø15/M14*1.5)

KI1015
Outer Tie Rod End
(Ø13.25*Ø15/M14*1.5)



HY1437
Rack End
(14*1.5/14*1.5/219)



KI1016
Outer Tie Rod End
(Ø13.25*Ø15/M14*1.5)



HY1517
Link Stabilizer
L=282.5



HY1917
Lower Ball Joint
(Ø15)



HY2118
Lower Control Arm Bush



HY1917
Lower Ball Joint
(Ø15)



HY2016
Lower Control Arm



HY2017
Lower Control Arm



HY2117
Lower Control Arm Bush



LEFT

RIGHT

HYUNDAI

ATOS

FRONT

ALL MODELS

Year

1998-

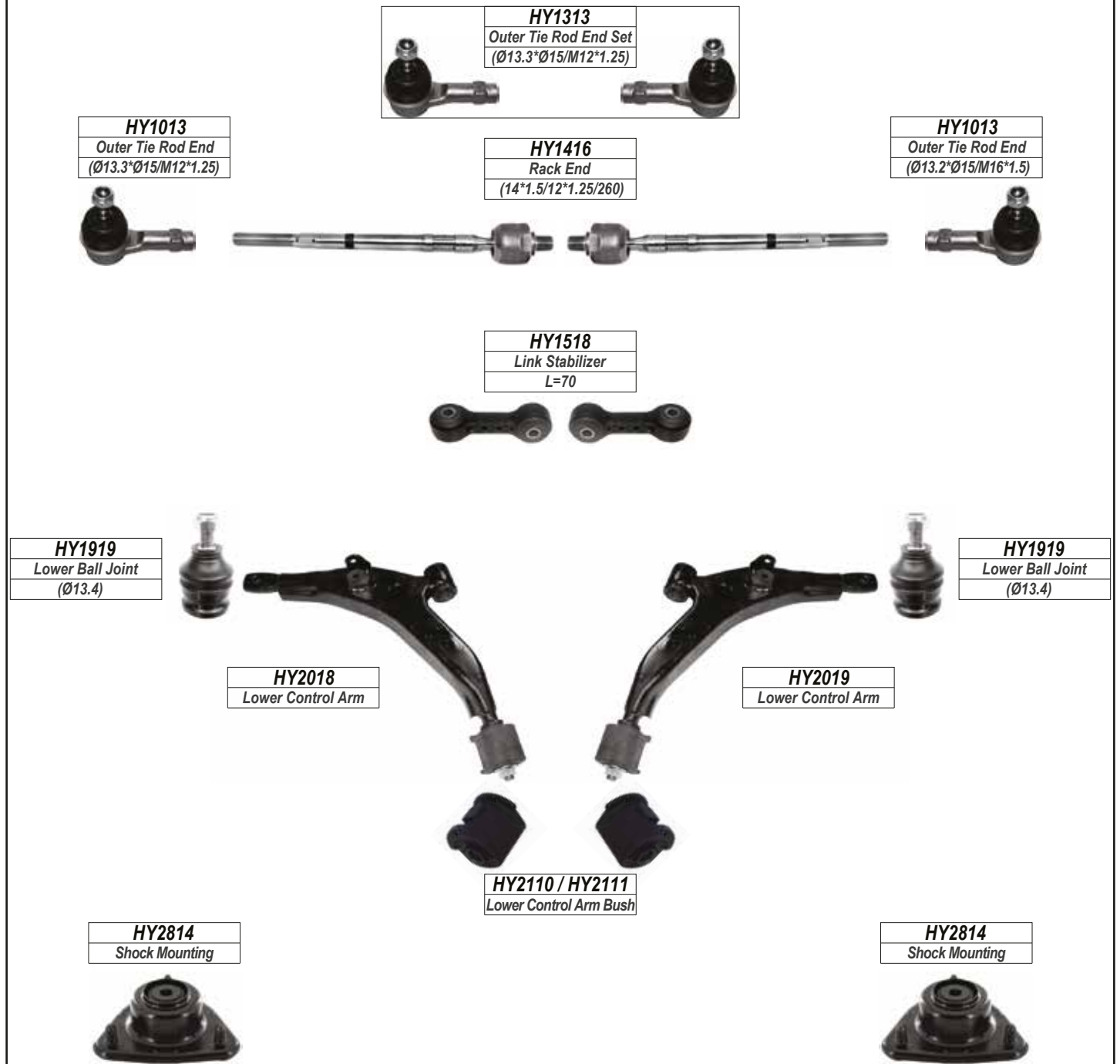

LEFT

RIGHT

HYUNDAI

AZERA

FRONT

ALL MODELS

Year

2015-

HY1330
Outer Tie Rod End Set
(Ø13.5*Ø15/M16*1.5)

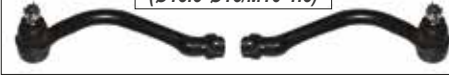

HY1043
Outer Tie Rod End
(Ø13.5*Ø15/M16*1.5)



HY1434
Rack End
(16*1.5/16*1.5/180)



HY1044
Outer Tie Rod End
(Ø13.5*Ø15/M16*1.5)



HY1614
Upper Ball Joint
(Ø13.5)



HY1714
Upper Control Arm



HY1715
Upper Control Arm

HY1614
Upper Ball Joint
(Ø13.5)



HY1931
Lower Ball Joint
(Ø15.1)



HY2137
Lower Control Arm Bush



HY2062
Lower Control Arm



HY2063
Lower Control Arm



HY1931
Lower Ball Joint
(Ø15.1)



HY2138
Lower Control Arm Bush



LEFT

RIGHT

HYUNDAI

CRETA

FRONT

ALL MODELS

Year

2015-



HY1333
Outer Tie Rod End Set
(Ø13.4*Ø15.4/M14*1.5)

HY1049
Outer Tie Rod End
(Ø13.4*Ø15.4/M14*1.5)

HY1438
Rack End
(16*1.5/14*1.5/353)

HY1050
Outer Tie Rod End
(Ø13.4*Ø15.4/M14*1.5)



HY1566
Link Stabilizer
(12*1.5/L=281)



HY2148
Lower Control Arm Bush

HY1933
Lower Ball Joint
(Ø15.1)



HY1933
Lower Ball Joint
(Ø15.1)



HY2076
Lower Control Arm

HY2077
Lower Control Arm

HY2149
Lower Control Arm Bush



HY2829
Shock Mounting



HY2829
Shock Mounting



LEFT

RIGHT

HYUNDAI

ELANTRA

FRONT

J1

Year

1993-1995

HY1310
Outer Tie Rod End Set
(Ø13.3*Ø15/M14*1.5)

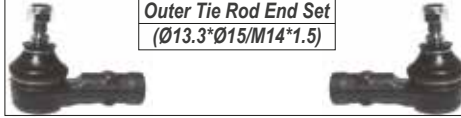

HY1010
Outer Tie Rod End
(Ø13.3*Ø15/M14*1.5)



HY1411
Rack End
(16*1.5/14*1.5/294)



HY1010
Outer Tie Rod End
(Ø13.3*Ø15/M14*1.5)



HY1521
Link Stabilizer
L=52



HY2120
Lower Control Arm Bush



HY1920
Lower Ball Joint
(Ø15)



HY1920
Lower Ball Joint
(Ø15)



HY2020
Lower Control Arm



HY2021
Lower Control Arm

HY2119
Lower Control Arm Bush



HY2815
Shock Mounting



HY2815
Shock Mounting



LEFT

RIGHT

HYUNDAI

ELANTRA. TIBURON FRONT

Year

J2

1996-2000

HY1010
Outer Tie Rod End
(Ø13.3*Ø15/M14*1.5)

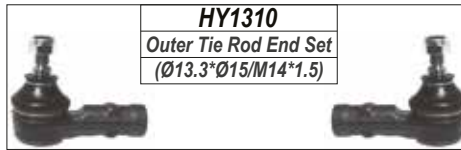

HY1310
Outer Tie Rod End Set
(Ø13.3*Ø15/M14*1.5)

HY1417
Rack End
(16*1.5/14*1.5/327)

HY1010
Outer Tie Rod End
(Ø13.3*Ø15/M14*1.5)



HY1519
Link Stabilizer
L=72



HY1917
Lower Ball Joint
(Ø15)



HY2143
Lower Control Arm Bush

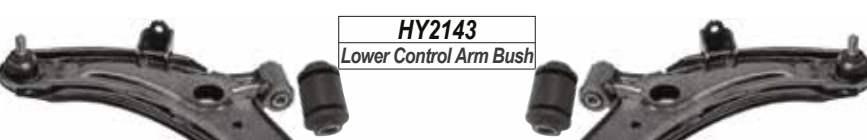

HY1917
Lower Ball Joint
(Ø15)

HY2022
Lower Control Arm

HY2023
Lower Control Arm

HY2815
Shock Mounting



HY2141 / HY2142
Lower Control Arm Bush

HY2815
Shock Mounting



ELANTRA. TIBURON REAR

HY1520
Link Stabilizer
L=130



LEFT

RIGHT

HYUNDAI

ELANTRA

FRONT

J3 XD

Year

2000-2006

HY1010
Outer Tie Rod End
(Ø13.3*Ø15/M14*1.5)

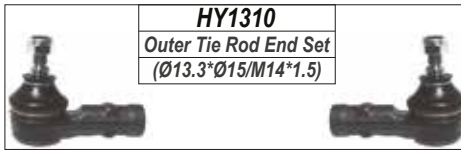

HY1310
Outer Tie Rod End Set
(Ø13.3*Ø15/M14*1.5)

HY1417
Rack End
(16*1.5/14*1.5/327)

HY1010
Outer Tie Rod End
(Ø13.3*Ø15/M14*1.5)



HY1014
Outer Tie Rod End
(Ø13.45*Ø15/M14*1.5)



HY1314
Outer Tie Rod End Set
(Ø13.45*Ø15/M14*1.5)

HY1418
Rack End
(16*1.5/14*1.5/324)

HY1014
Outer Tie Rod End
(Ø13.45*Ø15/M14*1.5)



HY1521
Link Stabilizer
L=52



HY1917
Lower Ball Joint
(Ø15)



HY2024
Lower Control Arm

HY2025
Lower Control Arm

HY1917
Lower Ball Joint
(Ø15)



ELANTRA

REAR

HY1520
Link Stabilizer
L=130



LEFT

RIGHT

HYUNDAI
ELANTRA
FRONT
J4 HD

Year

2006-

HY1010
Outer Tie Rod End
(Ø13.3*Ø15/M14*1.5)

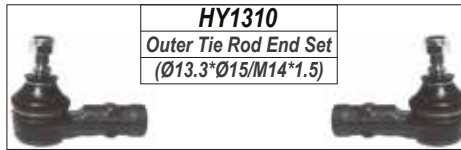

HY1310
Outer Tie Rod End Set
(Ø13.3*Ø15/M14*1.5)

HY1417
Rack End
(16*1.5/14*1.5/327)

HY1010
Outer Tie Rod End
(Ø13.3*Ø15/M14*1.5)



HY1023
Outer Tie Rod End
(Ø13.4*Ø15/M14*1.5)

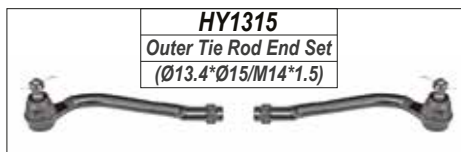

HY1315
Outer Tie Rod End Set
(Ø13.4*Ø15/M14*1.5)

HY1418
Rack End
(16*1.5/14*1.5/163)

HY1024
Outer Tie Rod End
(Ø13.4*Ø15/M14*1.5)



HY1521
Link Stabilizer
L=52



HY1917
Lower Ball Joint
(Ø15)



HY1917
Lower Ball Joint
(Ø15)



HY2024
Lower Control Arm

HY2025
Lower Control Arm

HY2813
Shock Mounting



HY2813
Shock Mounting

LEFT
RIGHT

HYUNDAI

ELANTRA

FRONT

J5 MD / UD

Year

2011-

HY1316
Outer Tie Rod End Set
(Ø13.4*Ø15/M16*1.5)



HY1025
Outer Tie Rod End
(Ø13.4*Ø15/M16*1.5)



HY1420
Rack End
(16*1.5/16*1.5/226)



HY1026
Outer Tie Rod End
(Ø13.4*Ø15/M16*1.5)



HY1517
Link Stabilizer
L=282.5



HY1917
Lower Ball Joint
(Ø15)



HY2121
Lower Control Arm Bush



HY1917
Lower Ball Joint
(Ø15)



HY2026
Lower Control Arm



HY2027
Lower Control Arm



HY2117
Lower Control Arm Bush



HY2072
Lower Control Arm
Year 2014-



HY2073
Lower Control Arm
Year 2014-



HY2816
Shock Mounting



HY2816
Shock Mounting



LEFT

RIGHT

HYUNDAI

ELANTRA

FRONT

AD

Year

2017-

HY1027
Outer Tie Rod End
(Ø13.4*Ø15.1/M16*1.5)

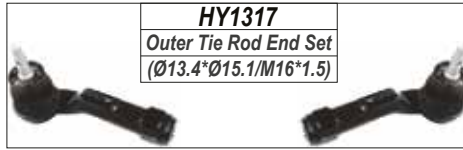

HY1317
Outer Tie Rod End Set
(Ø13.4*Ø15.1/M16*1.5)

HY1421
Rack End
(16*1.5/16*1.5/299.5)



HY1028
Outer Tie Rod End
(Ø13.4*Ø15.1/M16*1.5)



HY1522
Link Stabilizer
L=282.5



HY1910
Lower Ball Joint
(Ø15)



HY2028
Lower Control Arm

HY2029
Lower Control Arm

HY1911
Lower Ball Joint
(Ø15)



LEFT

RIGHT

HYUNDAI

GETZ

FRONT

ALL MODELS

Year

2003-

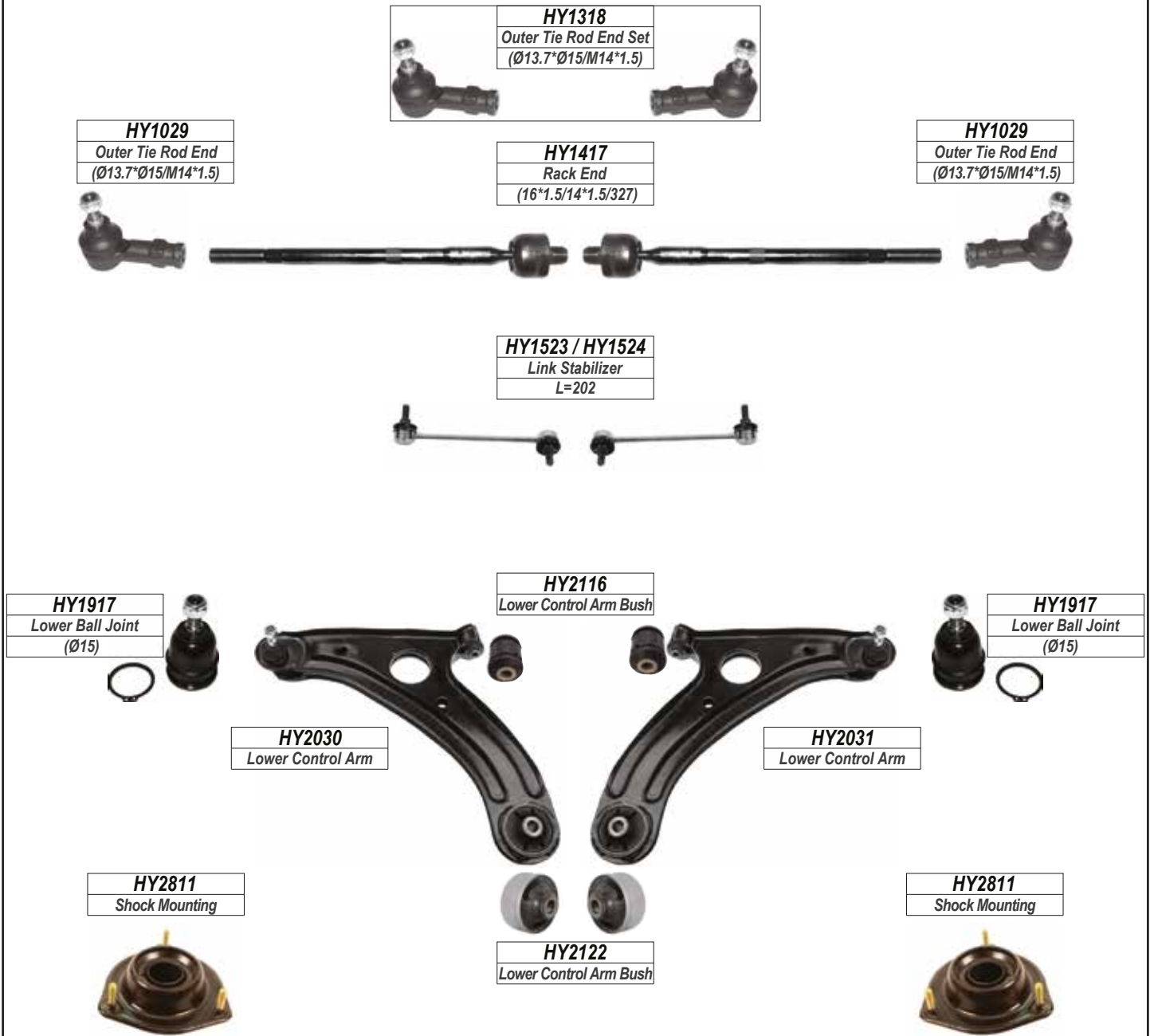

GETZ

REAR

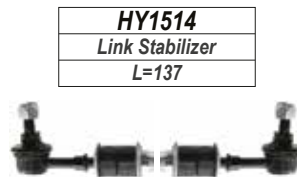

LEFT

RIGHT

HYUNDAI

H1

FRONT

ALL MODELS

Year

2008-

HY1030
Outer Tie Rod End
(Ø13.75*Ø16/M14*1.5)



HY1319
Outer Tie Rod End Set
(Ø13.75*Ø16/M14*1.5)

HY1422
Rack End
(18*1.5/14*1.5/241)



HY1031
Outer Tie Rod End
(Ø13.75*Ø16/M14*1.5)



HY1525 / HY1526
Link Stabilizer
L=275



HY1517
Link Stabilizer
L=282.5



HY1921
Lower Ball Joint
(Ø20)



HY2144
Lower Control Arm Bush



HY2032
Lower Control Arm

HY2033
Lower Control Arm

HY1921
Lower Ball Joint
(Ø20)



HY2817
Shock Mounting



HY2123
Lower Control Arm Bush



HY2817
Shock Mounting



H1

REAR

HY1527 / HY1528
Link Stabilizer
L=85



LEFT

RIGHT

HYUNDAI

H-100

FRONT

ALL MODELS

Year

1997-

HY1032
Outer Tie Rod End
(Ø13.3*Ø15/M14*1.5)

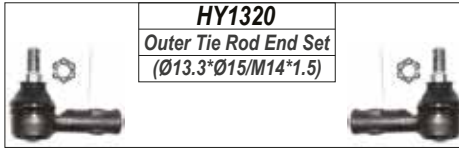

HY1320
Outer Tie Rod End Set
(Ø13.3*Ø15/M14*1.5)

HY1423
Rack End
(16*1.5/14*1.5/286)

HY1032
Outer Tie Rod End
(Ø13.3*Ø15/M14*1.5)



HY1033
Outer Tie Rod End
(Ø13.7*Ø15.9/M16*1.5)

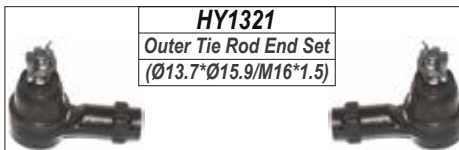

HY1321
Outer Tie Rod End Set
(Ø13.7*Ø15.9/M16*1.5)

HY1424
Rack End
(16*1.5/16*1.5/302)

HY1033
Outer Tie Rod End
(Ø13.7*Ø15.9/M16*1.5)



HY1612
Upper Ball Joint
(Ø17.6)



HY1710
Upper Control Arm

HY1711
Upper Control Arm

HY1612
Upper Ball Joint
(Ø17.6)



HY2034
Lower Control Arm

HY2035
Lower Control Arm

HY1923
Lower Ball Joint
(Ø19.5)



HY2124
Lower Control Arm Bush



HY1923
Lower Ball Joint
(Ø19.5)



HY2036
Lower Control Arm

HY2037
Lower Control Arm

HY2136
Lower Control Arm Bush



LEFT

RIGHT

HYUNDAI

I10

FRONT

ALL MODELS

Year

2008-2014

HY1034
Outer Tie Rod End
(Ø13.44*Ø15/M12*1.25)

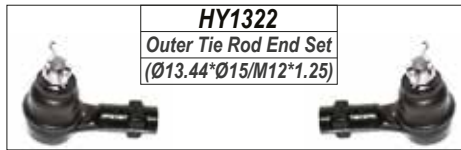

HY1322
Outer Tie Rod End Set
(Ø13.44*Ø15/M12*1.25)

HY1425
Rack End
(16*1.5/12*1.25/295)

HY1034
Outer Tie Rod End
(Ø13.44*Ø15/M12*1.25)

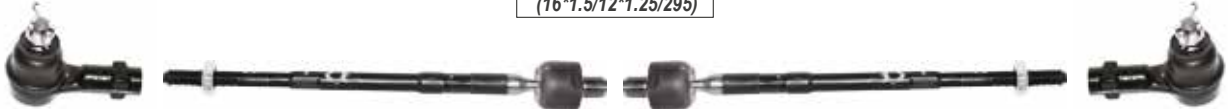

HY1529 / HY1530
Link Stabilizer
L=229.5



HY1924
Lower Ball Joint
(Ø16)



HY2116
Lower Control Arm Bush



HY1924
Lower Ball Joint
(Ø16)



HY2038
Lower Control Arm



HY2039
Lower Control Arm



HY2125
Lower Control Arm Bush



HY2818
Shock Mounting



HY2818
Shock Mounting



LEFT

RIGHT

HYUNDAI

I10

FRONT

ALL MODELS

Year

2014-

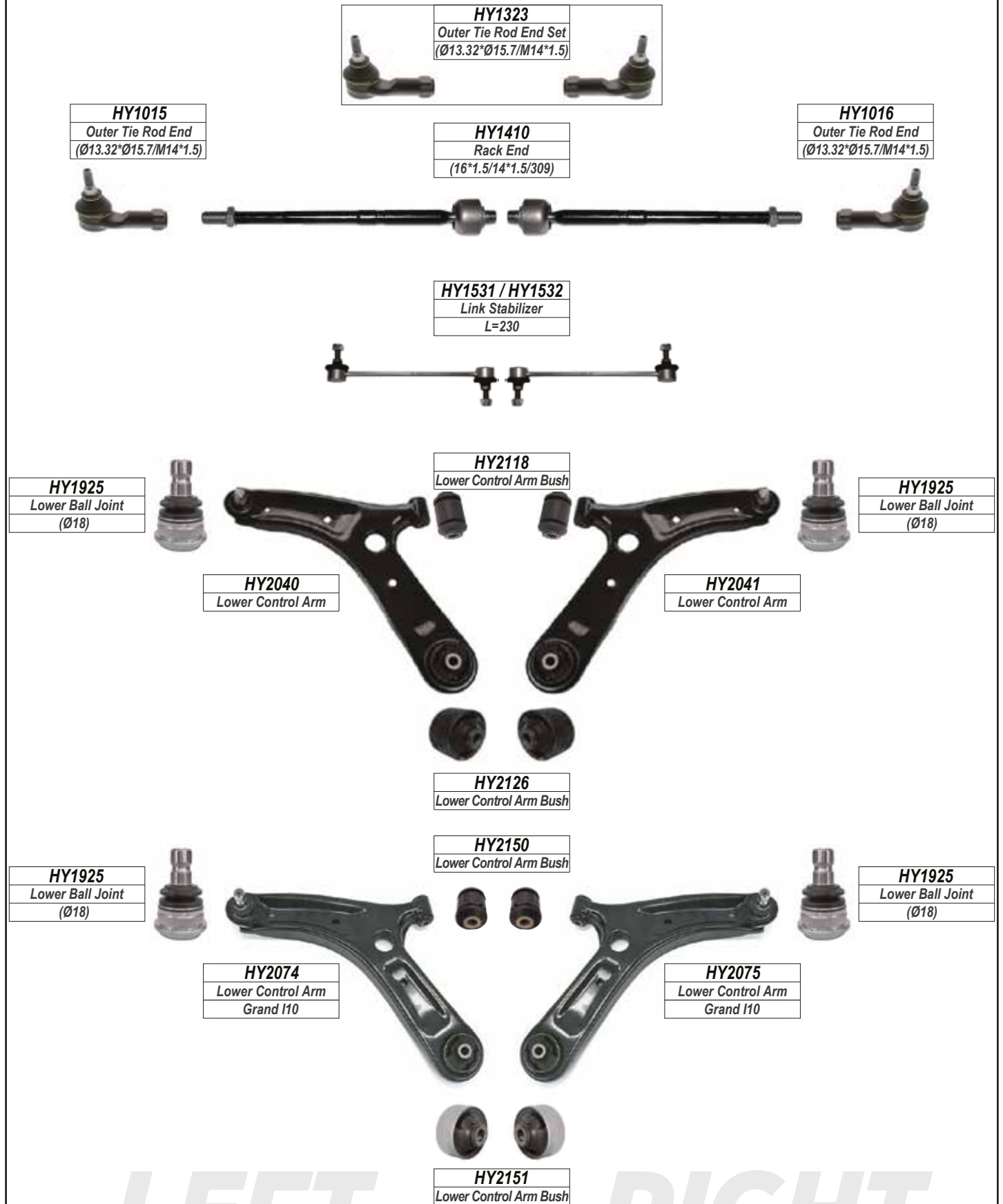

HYUNDAI

I20

FRONT

ALL MODELS

Year

2008-

HY1324
Outer Tie Rod End Set
(Ø13.4*Ø15/M16*1.5)



HY1017
Outer Tie Rod End
(Ø13.4*Ø15/M16*1.5)



HY1426
Rack End
(16*1.5/16*1.5/224)



HY1018
Outer Tie Rod End
(Ø13.4*Ø15/M16*1.5)



HY1533 / HY1534
Link Stabilizer
L=216



HY2116
Lower Control Arm Bush



HY1917
Lower Ball Joint
(Ø15)



HY1917
Lower Ball Joint
(Ø15)



HY2042
Lower Control Arm

HY2043
Lower Control Arm

HY2115
Lower Control Arm Bush



HY2819
Shock Mounting



HY2819
Shock Mounting



LEFT

RIGHT

HYUNDAI

I20

FRONT

ALL MODELS

Year

2015-

HY1019
Outer Tie Rod End
(Ø13.4*Ø15/M16*1.5)

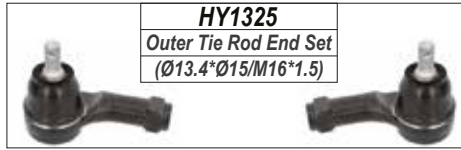

HY1325
Outer Tie Rod End Set
(Ø13.4*Ø15/M16*1.5)

HY1427
Rack End
(16*1.5/16*1.5/224)

HY1020
Outer Tie Rod End
(Ø13.4*Ø15/M16*1.5)



HY1535
Link Stabilizer
L=282.5



HY2078
Lower Control Arm

HY2079
Lower Control Arm

HY2127
Lower Control Arm Bush

HY1912
Lower Ball Joint
(Ø15)



HY1912
Lower Ball Joint
(Ø15)



HY2044
Lower Control Arm



HY2045
Lower Control Arm

HY2128
Lower Control Arm Bush



LEFT

RIGHT

HYUNDAI

I30

FRONT

FD

Year

2009-2011

HY1315
Outer Tie Rod End Set
(Ø13.4*Ø15/M14*1.5)

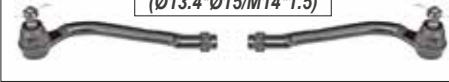

HY1023
Outer Tie Rod End
(Ø13.4*Ø15/M14*1.5)



HY1419
Rack End
(16*1.5/14*1.5/163)



HY1024
Outer Tie Rod End
(Ø13.4*Ø15/M14*1.5)



HY1536
Link Stabilizer
L=243.5



HY2130
Lower Control Arm Bush



HY1926
Lower Ball Joint
(Ø15)



HY1926
Lower Ball Joint
(Ø15)

HY2046
Lower Control Arm

HY2047
Lower Control Arm

HY2813
Shock Mounting



HY2813
Shock Mounting



HY2129
Lower Control Arm Bush



I30

REAR

HY1537
Link Stabilizer
L=170



HY2821
Shock Mounting



HY2821
Shock Mounting



HY1538
Link Stabilizer
L=195



LEFT

RIGHT

HYUNDAI

I30

FRONT

GD

Year

2011-

HY1025
Outer Tie Rod End
(Ø13.4*Ø15.1/M16*1.5)

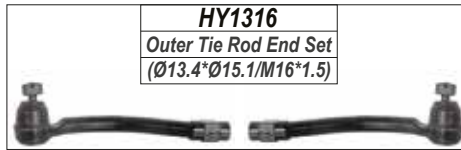

HY1316
Outer Tie Rod End Set
(Ø13.4*Ø15.1/M16*1.5)

HY1428
Rack End
(16*1.5/16*1.5/218)



HY1026
Outer Tie Rod End
(Ø13.4*Ø15.1/M16*1.5)



HY1536
Link Stabilizer
L=243.5



HY2121
Lower Control Arm Bush

HY1927
Lower Ball Joint
(Ø18)



HY2048
Lower Control Arm



HY2049
Lower Control Arm

HY1927
Lower Ball Joint
(Ø18)



HY2820
Shock Mounting



HY2131
Lower Control Arm Bush



HY2820
Shock Mounting



I30

REAR

HY1537
Link Stabilizer
L=170



HY1538
Link Stabilizer
L=195

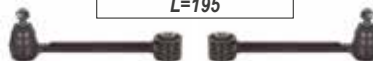

LEFT

RIGHT

HYUNDAI

IX35

FRONT

LM

Year

2010-

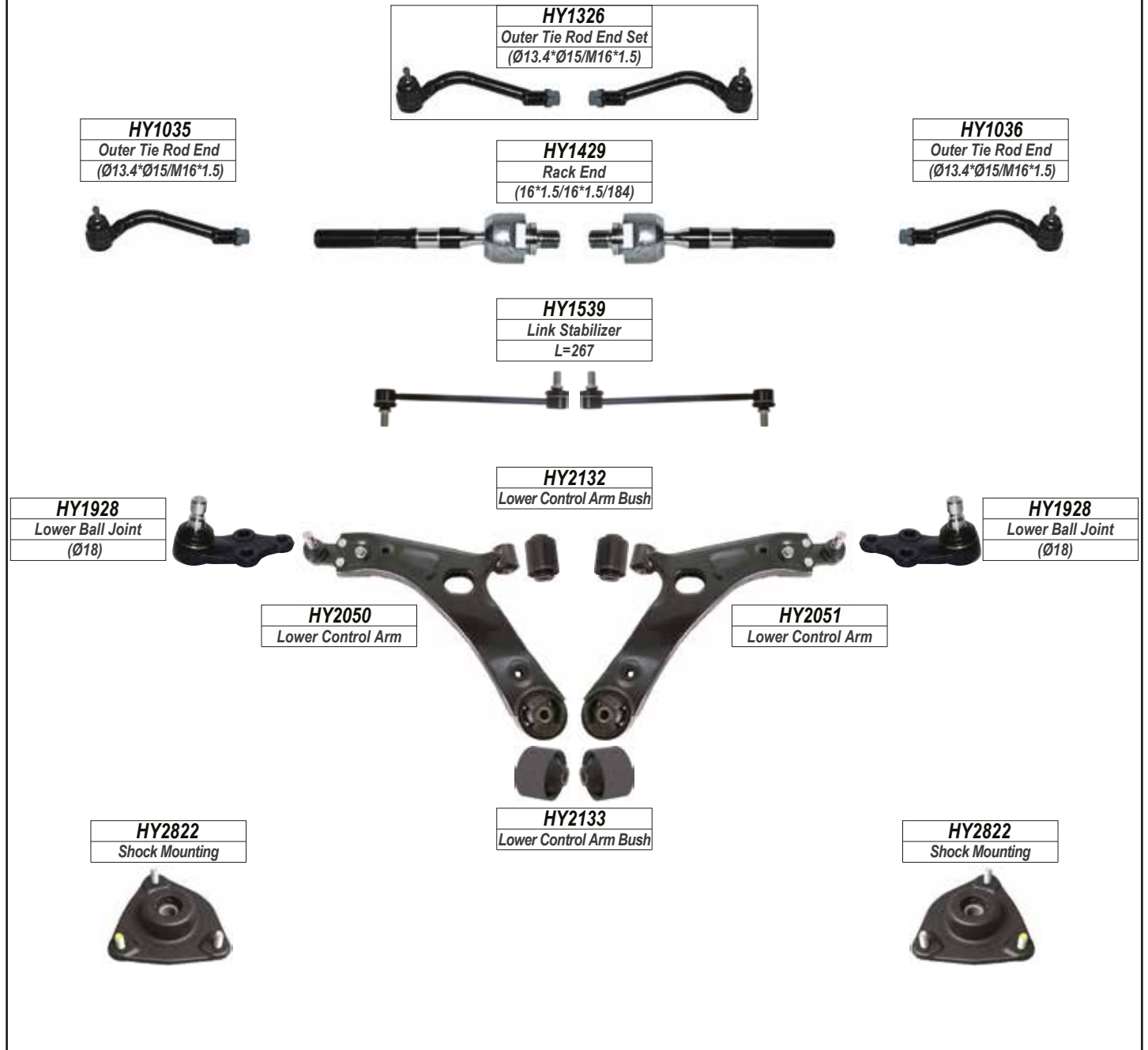

IX35

REAR



LEFT

RIGHT

HYUNDAI

MATRIX

FRONT

ALL MODELS

Year

2001-2007

HY1310

Outer Tie Rod End Set
(Ø13.3*Ø15/M14*1.5)

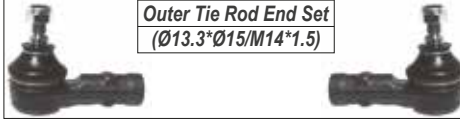

HY1010

Outer Tie Rod End
(Ø13.3*Ø15/M14*1.5)



HY1418

Rack End
(16*1.5/14*1.5/324)



HY1010

Outer Tie Rod End
(Ø13.3*Ø15/M14*1.5)



HY1511 / HY1512

Link Stabilizer
L=59



HY2113

Lower Control Arm Bush



HY1917

Lower Ball Joint
(Ø15)



HY2052

Lower Control Arm



HY2053

Lower Control Arm

HY1917

Lower Ball Joint
(Ø15)



HY2147

Lower Control Arm Bush



HY2815

Shock Mounting



HY2815

Shock Mounting



MATRIX

REAR

HY1520

Link Stabilizer
L=130



LEFT

RIGHT

HYUNDAI

SANTA-FE

FRONT

SM

Year

2001-2006

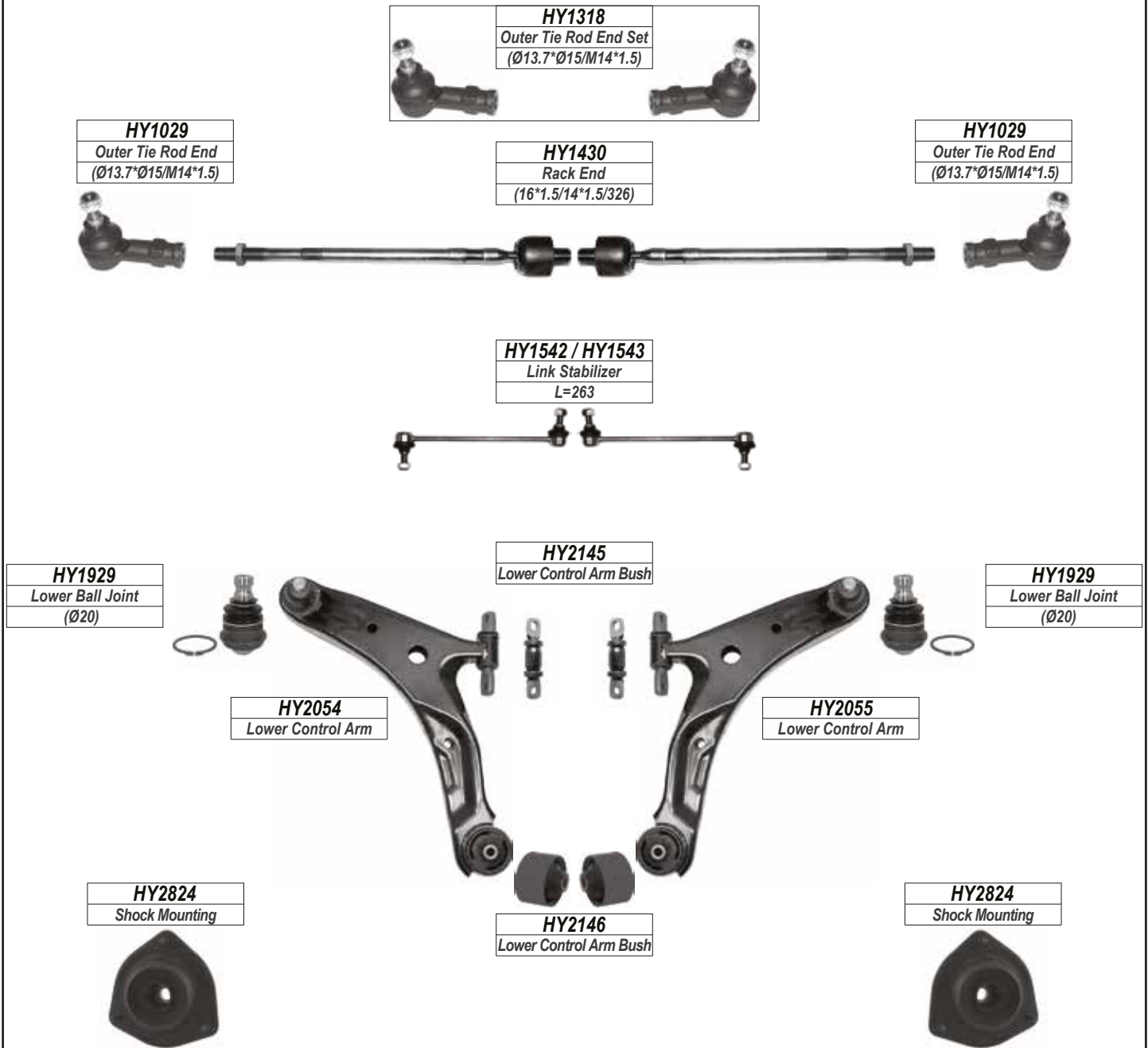

SANTA-FE

REAR



LEFT

RIGHT

HYUNDAI

SANTA-FE

FRONT

CM

Year

2006-

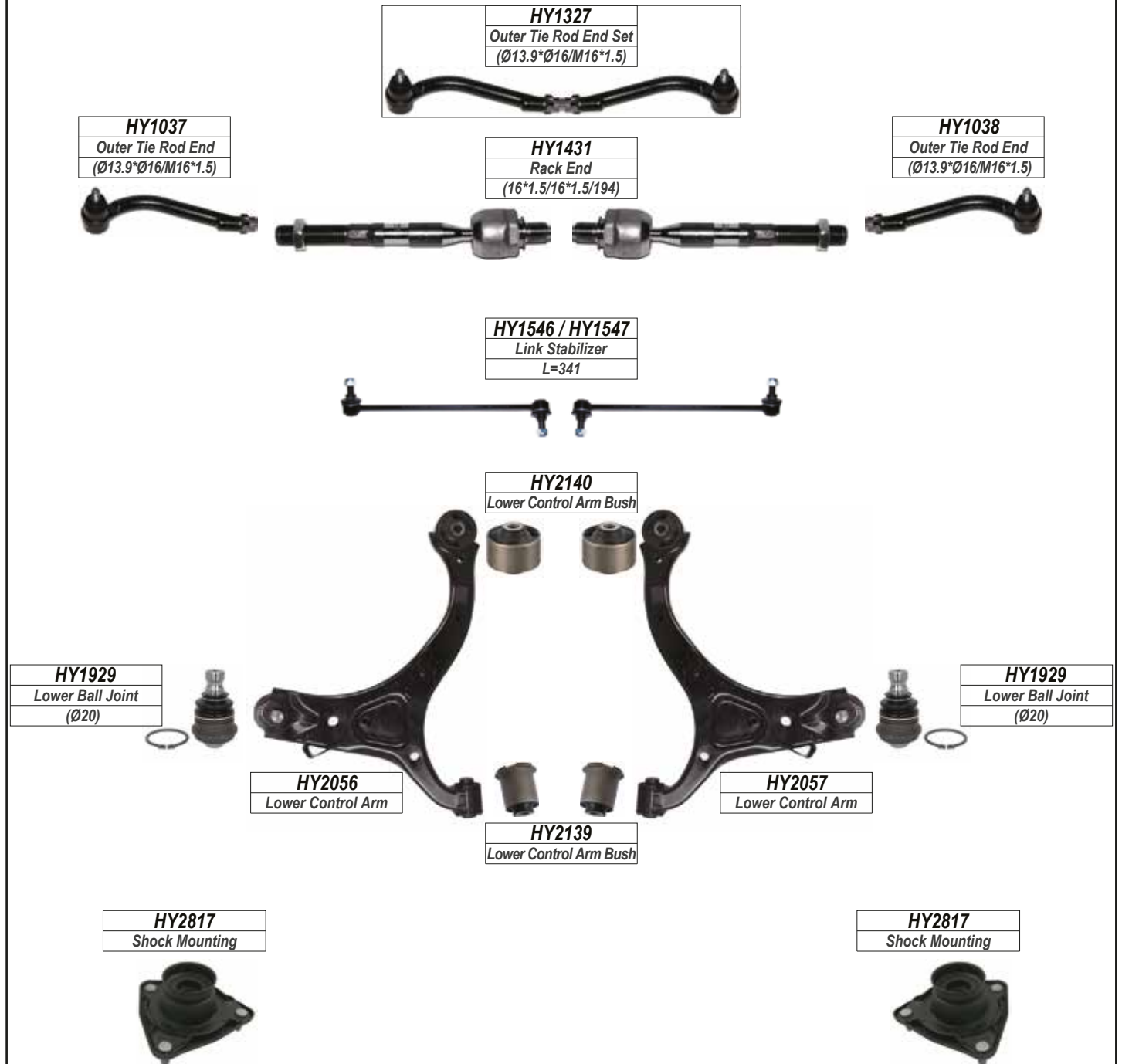

SANTA-FE

REAR



LEFT

RIGHT

HYUNDAI

SANTA-FE

FRONT

DM

Year

2012-

HY1039
Outer Tie Rod End
(Ø13.4*Ø16/M16*1.5)



HY1328
Outer Tie Rod End Set
(Ø13.4*Ø16/M16*1.5)

HY1432
Rack End
(16*1.5/16*1.5/192)



HY1040
Outer Tie Rod End
(Ø13.4*Ø16/M16*1.5)



HY1549
Link Stabilizer
L=328



HY1927
Lower Ball Joint
(Ø18)



HY2058
Lower Control Arm



HY2059
Lower Control Arm

HY1927
Lower Ball Joint
(Ø18)



SANTA-FE

REAR

HY1550 / HY1551
Link Stabilizer
L=88



KI1538
Link Stabilizer
L=90



HY2610
Lateral Link



LEFT

RIGHT

HYUNDAI

SONATA

FRONT

Year

1994-1998

II

HY1029
Outer Tie Rod End
(Ø13.7*Ø15/M14*1.5)

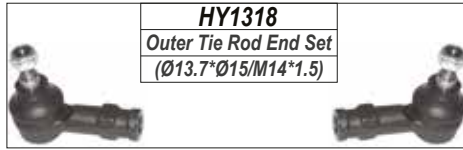

HY1318
Outer Tie Rod End Set
(Ø13.7*Ø15/M14*1.5)

HY1417
Rack End
(16*1.5/14*1.5/327)

HY1029
Outer Tie Rod End
(Ø13.7*Ø15/M14*1.5)



HY1913
Lower Ball Joint
(Ø15.1)



HY1913
Lower Ball Joint
(Ø15.1)



HY2825
Shock Mounting



HY2825
Shock Mounting



LEFT

RIGHT

HYUNDAI

SONATA

FRONT

Year

1998-2002

III

HY1329
Outer Tie Rod End Set
(Ø13.45*Ø15/M14*1.5)



HY1041
Outer Tie Rod End
(Ø13.45*Ø15/M14*1.5)



HY1433
Rack End
(16*1.5/14*1.5/166)



HY1042
Outer Tie Rod End
(Ø13.45*Ø15/M14*1.5)



HY1552
Link Stabilizer
L=102.5



HY1613
Upper Ball Joint
(Ø13.4)



HY1613
Upper Ball Joint
(Ø13.4)



HY2826
Shock Mounting



HY2826
Shock Mounting



SONATA

REAR

HY1553
Link Stabilizer
L=108



LEFT

RIGHT

HYUNDAI

SONATA

FRONT

IV

Year

2002-2006

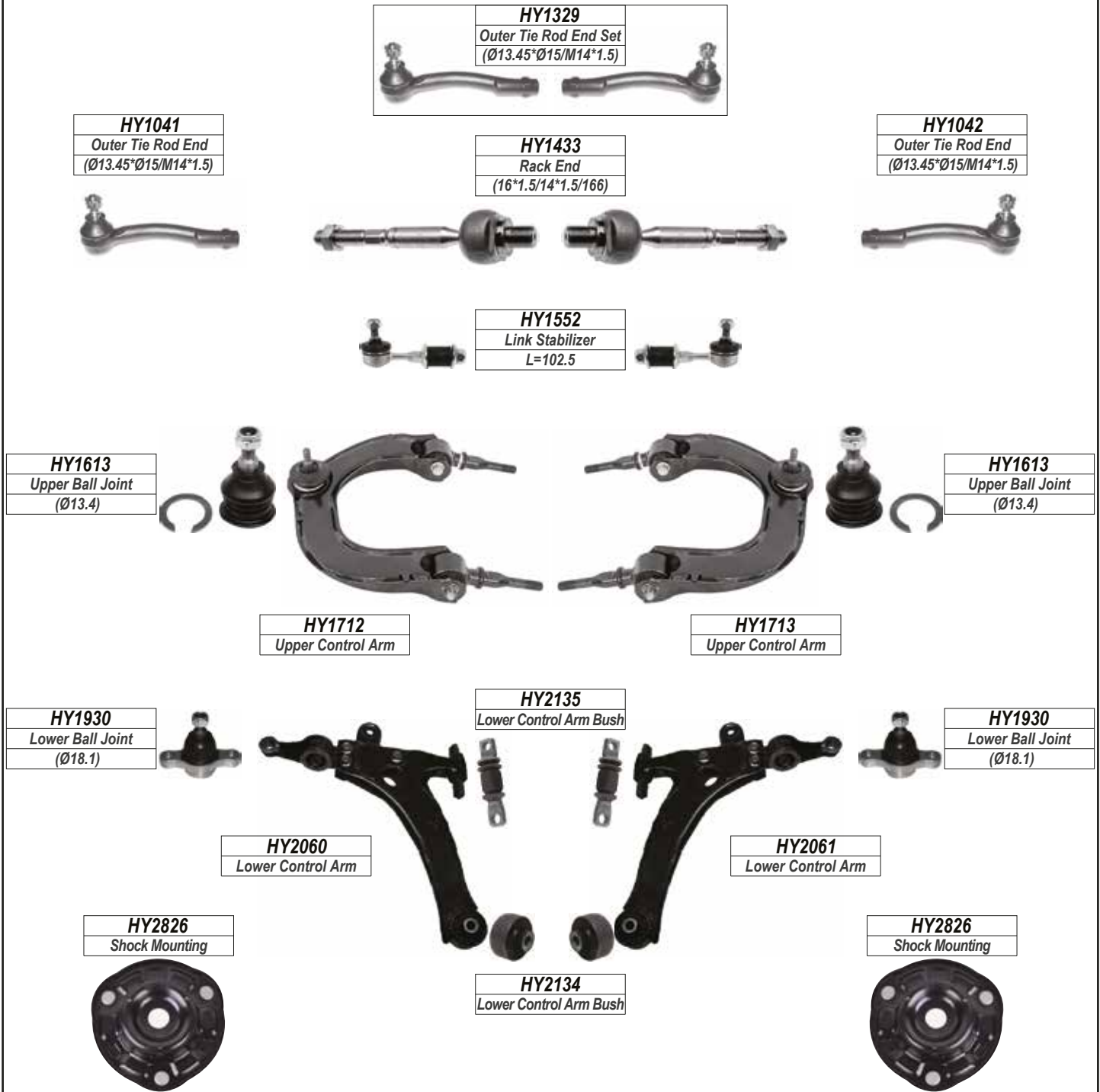

SONATA

REAR

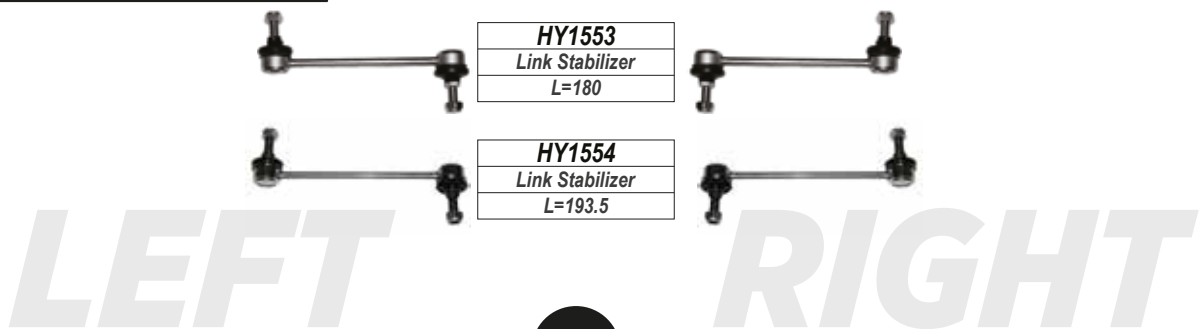

HYUNDAI

SONATA

FRONT

Year

2006-2010

V

HY1330
Outer Tie Rod End Set
(Ø13.5*Ø15/M16*1.5)

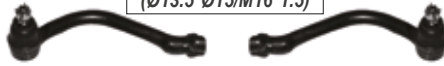

HY1043
Outer Tie Rod End
(Ø13.5*Ø15/M16*1.5)



HY1434
Rack End
(16*1.5/16*1.5/180)



HY1044
Outer Tie Rod End
(Ø13.5*Ø15/M16*1.5)



HY1555
Link Stabilizer
L=150

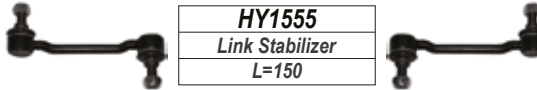

HY1614
Upper Ball Joint
(Ø13.5)



HY1714
Upper Control Arm

HY1715
Upper Control Arm

HY1614
Upper Ball Joint
(Ø13.5)



HY2137
Lower Control Arm Bush



HY1931
Lower Ball Joint
(Ø15.1)



HY2062
Lower Control Arm

HY2063
Lower Control Arm

HY1931
Lower Ball Joint
(Ø15.1)



HY2810
Stabilizer Bush



HY2810
Stabilizer Bush



HY2827
Shock Mounting



HY2827
Shock Mounting



HY2138
Lower Control Arm Bush



SONATA

REAR

HY2828
Shock Mounting



HY1556
Link Stabilizer
L=80



HY2828
Shock Mounting



LEFT

RIGHT

HYUNDAI

SONATA

FRONT

Year

2010-2014

VI

HY1035
Outer Tie Rod End
(Ø13.4*Ø15/M16*1.5)



HY1326
Outer Tie Rod End Set
(Ø13.4*Ø15/M16*1.5)

HY1432
Rack End
(16*1.5/16*1.5/195)



HY1036
Outer Tie Rod End
(Ø13.4*Ø15/M16*1.5)



HY1557 / HY1558
Link Stabilizer
L=351.5



HY1927
Lower Ball Joint
(Ø18)



HY2064
Lower Control Arm



HY2065
Lower Control Arm

HY1927
Lower Ball Joint
(Ø18)



CH2811
Shock Mounting



CH2811
Shock Mounting



SONATA

REAR

HY1559
Link Stabilizer
L=195



LEFT

RIGHT

HYUNDAI

TIBURON

FRONT

ALL MODELS

Year

2000-

HY1010
Outer Tie Rod End
(Ø13.3*Ø15/M14*1.5)

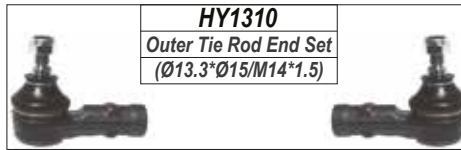

HY1310
Outer Tie Rod End Set
(Ø13.3*Ø15/M14*1.5)

HY1417
Rack End
(16*1.5/14*1.5/327)

HY1010
Outer Tie Rod End
(Ø13.3*Ø15/M14*1.5)



HY1519
Link Stabilizer
L=72



HY1610
Upper Ball Joint
(Ø15)



HY1714
Upper Control Arm



HY1715
Upper Control Arm

HY1610
Upper Ball Joint
(Ø15)



HY1917
Lower Ball Joint
(Ø15)



HY1917
Lower Ball Joint
(Ø15)



HY2815
Shock Mounting



HY2815
Shock Mounting



LEFT

RIGHT

HYUNDAI

TERRECAN

FRONT

ALL MODELS

Year

2003-2008

HY2310
Drag Link



HY1560 / HY1561
Link Stabilizer
L=72



HY1611
Upper Ball Joint
(Ø16)



HY1716
Upper Control Arm

HY1717
Upper Control Arm

HY1611
Upper Ball Joint
(Ø16)



HY1914
Lower Ball Joint
(Ø19.5)



HY2070
Lower Control Arm

HY2071
Lower Control Arm

HY1914
Lower Ball Joint
(Ø19.5)



LEFT

RIGHT

HYUNDAI

TUCSON

FRONT

ALL MODELS

Year

2004-2010

HY1045
Outer Tie Rod End
(Ø13.45*Ø15/M16*1.5)



HY1331
Outer Tie Rod End Set
(Ø13.45*Ø15/M16*1.5)

HY1435
Rack End
(16*1.5/16*1.5/241)



HY1046
Outer Tie Rod End
(Ø13.45*Ø15/M16*1.5)



HY1510
Link Stabilizer
L=238



HY2115
Lower Control Arm Bush



HY2130
Lower Control Arm Bush

HY1932
Lower Ball Joint
(Ø14.55)



HY1932
Lower Ball Joint
(Ø14.55)



HY2066
Lower Control Arm

HY2067
Lower Control Arm

HY2822
Shock Mounting



HY2822
Shock Mounting



TUCSON

REAR

HY1563
Link Stabilizer
L=219



LEFT

RIGHT

HYUNDAI

TUCSON

FRONT

ALL MODELS

Year

2015-

HY1047
Outer Tie Rod End
(Ø13.85*Ø16.1/M14*1.5)



HY1332
Outer Tie Rod End Set
(Ø13.85*Ø16.1/M14*1.5)

HY1436
Rack End
(16*1.5/14*1.5/242.5)



HY1048
Outer Tie Rod End
(Ø13.85*Ø16.1/M14*1.5)



HY1535
Link Stabilizer
L=282.5



HY1915
Lower Ball Joint
(Ø18)



HY2068
Lower Control Arm



HY2069
Lower Control Arm



HY1916
Lower Ball Joint
(Ø18)



TUCSON

REAR

HY1564
Link Stabilizer
L=140



LEFT

RIGHT

HYUNDAI

VELOSTER

FRONT

ALL MODELS

Year

2013-

HY1025
Outer Tie Rod End
(Ø13.4*Ø15/M14*1.5)

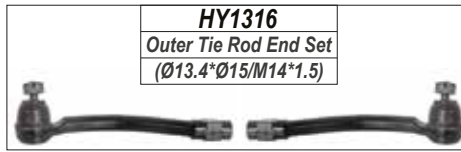

HY1316
Outer Tie Rod End Set
(Ø13.4*Ø15/M14*1.5)

HY1420
Rack End
(16*1.5/16*1.5/226)



HY1026
Outer Tie Rod End
(Ø13.4*Ø15/M14*1.5)



HY1517
Link Stabilizer
L=282.5



HY1917
Lower Ball Joint
(Ø15)



HY2121
Lower Control Arm Bush



HY1917
Lower Ball Joint
(Ø15)



HY2026
Lower Control Arm



HY2027
Lower Control Arm

HY2117
Lower Control Arm Bush



LEFT

RIGHT

ISUZU

KB

FRONT

ALL MODEL

Year

1981-1989

IS2210
Center Rod



IS1310
Outer Tie Rod End Set
(Ø13.55*Ø15.1/M14*1.5)

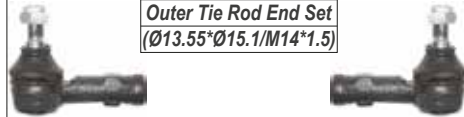

IS1011
Outer Tie Rod End
(Ø13.55*Ø15.1/M14*1.5)



IS1410
Rack End
(14*1.5/14*1.5/265)



IS1011
Outer Tie Rod End
(Ø13.55*Ø15.1/M14*1.5)



IS1411
Rack End
(14*1.5/14*1.5/244)



IS1610
Upper Ball Joint
(Ø17.6)



IS1610
Upper Ball Joint
(Ø17.6)



IS1910
Lower Ball Joint
(Ø17.57)



IS1910
Lower Ball Joint
(Ø17.57)



IS1911
Lower Ball Joint
(Ø19.6)



IS1911
Lower Ball Joint
(Ø19.6)



IS2410
Idler Arm



LEFT

RIGHT

ISUZU

KB

FRONT

2WD

Year

1989-2004



IS2211
Center Rod

IS2212 / IS2213
Center Rod

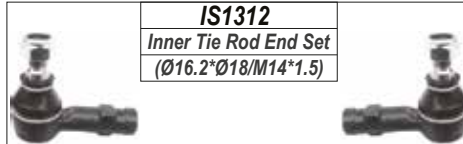

IS1312
Inner Tie Rod End Set
(Ø16.2*Ø18/M14*1.5)

IS1012
Outer Tie Rod End
(Ø16.2*Ø18/M14*1.5)



IS1110
Inner Tie Rod End
(Ø16.2*Ø18/M14*1.5)



IS1110
Inner Tie Rod End
(Ø16.2*Ø18/M14*1.5)



IS1012
Outer Tie Rod End
(Ø16.2*Ø18/M14*1.5)



IS1210
Tie Rod End Assembly



IS1210
Tie Rod End Assembly



FT1510 / FT1511
Link Stabilizer
L=155

IS1610
Upper Ball Joint
(Ø17.6)



IS1610
Upper Ball Joint
(Ø17.6)

IS1710
Upper Control Arm
1989-1998

IS1711
Upper Control Arm
1989-1998



IS1712
Upper Control Arm
1998-2004



IS1713
Upper Control Arm
1998-2004

LEFT

RIGHT

ISUZU

KB

FRONT

2WD

Year

1989-2004



IS1714
Upper Control Arm
320 Only

IS1715
Upper Control Arm
320 Only

IS1912
Lower Ball Joint
(Ø20.5)



IS1912
Lower Ball Joint
(Ø20.5)

IS2010
Lower Control Arm

IS2011
Lower Control Arm



FT2010
Lower Control Arm
1997-1999 (320 Only)

FT2011
Lower Control Arm
1997-1999 (320 Only)

FT1911
Lower Ball Joint
(Ø20.6)(320 Only)



FT1911
Lower Ball Joint
(Ø20.6)(320 Only)

IS2410
Idler Arm



IS2012
Lower Control Arm
2000-2004 (320 Only)

IS2013
Lower Control Arm
2000-2004 (320 Only)

LEFT

RIGHT

ISUZU

KB

FRONT

4WD

Year

1989-2004

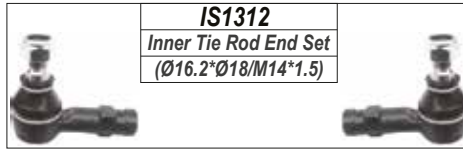

IS1012 Outer Tie Rod End (Ø16.2*Ø18/M14*1.5)



IS1110 Inner Tie Rod End (Ø16.2*Ø18/M14*1.5)



IS1110 Inner Tie Rod End (Ø16.2*Ø18/M14*1.5)



IS1012 Outer Tie Rod End (Ø16.2*Ø18/M14*1.5)



FT1510 / FT1511 Link Stabilizer L=155
--



IS1610 Upper Ball Joint (Ø17.6)
--



IS1610 Upper Ball Joint (Ø17.6)
--

IS1716 Upper Control Arm 1989-1997

IS1717 Upper Control Arm 1989-1997



IS1714 Upper Control Arm 1998-2004

IS1715 Upper Control Arm 1998-2004

LEFT

RIGHT

ISUZU

KB

FRONT

4WD

Year

1989-2004

FT1911

Lower Ball Joint
(Ø20.6)



FT2010

Lower Control Arm
1989-1999



FT2011

Lower Control Arm
1989-1999



FT1911

Lower Ball Joint
(Ø20.6)



IS2012

Lower Control Arm
2000-2004



IS2013

Lower Control Arm
2000-2004

IS2410

Idler Arm



LEFT

RIGHT

ISUZU

KB/D-MAX

FRONT

ALL MODEL

Year

2004-

FT1010
Outer Tie Rod End
(Ø16.1*Ø18/M14*1.5)

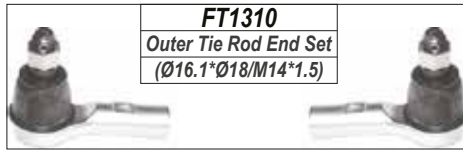

FT1310
Outer Tie Rod End Set
(Ø16.1*Ø18/M14*1.5)

FT1010
Outer Tie Rod End
(Ø16.1*Ø18/M14*1.5)



IS1412
Rack End
(14*1.5/14*1.5/303)



IS1413
Rack End
(14*1.5/14*1.5/290)



IS1414
Rack End
(18*1.5/14*1.5/294)

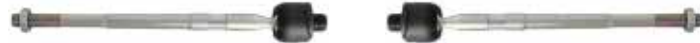

IS1510
Link Stabilizer
L=114.5



FT1510 / FT1511
Link Stabilizer
L=155



FT1610
Upper Ball Joint
(Ø17.56)



FT1610
Upper Ball Joint
(Ø17.56)



FT1712
Upper Control Arm
HI-RIDER

FT1713
Upper Control Arm
HI-RIDER

FT1611
Upper Ball Joint
(Ø17.6)



FT1611
Upper Ball Joint
(Ø17.6)



FT1714
Upper Control Arm

FT1715
Upper Control Arm

LEFT

RIGHT

ISUZU

KB/D-MAX

FRONT

ALL MODEL

Year

2004-



IS1718
Upper Control Arm



IS1719
Upper Control Arm



IS2014
Lower Control Arm
STD-BODY



IS2015
Lower Control Arm
STD-BODY



FT1911
Lower Ball Joint
(Ø20.6)



FT1911
Lower Ball Joint
(Ø20.6)



IS2016
Lower Control Arm
HI-RIDER

IS2017
Lower Control Arm
HI-RIDER

LEFT

RIGHT

ISUZU

RELAY

FRONT

ALL MODEL

Year

1983-1995

IS1313

Outer Tie Rod End Set
(Ø13.3*Ø15.4/M16*1.5)

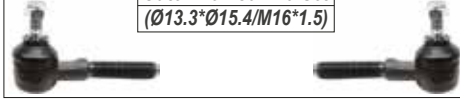

IS1314

Inner Tie Rod End Set
(Ø13.3*Ø15.4/M16*1.5)

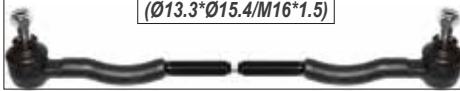

IS1010

Outer Tie Rod End
(Ø13.3*Ø15.4/M16*1.5)



IS1111

Inner Tie Rod End
(Ø13.3*Ø15.4/M16*1.5)



IS1010

Outer Tie Rod End
(Ø13.3*Ø15.4/M16*1.5)



IS1610

Upper Ball Joint
(Ø17.6)



IS1610

Upper Ball Joint
(Ø17.6)



LEFT

RIGHT

IVECO

DAILY

FRONT

Year

1999-2006

II

IV1010(P/S)
Outer Tie Rod End
(Ø21.6*Ø24.6/M20*1.5)

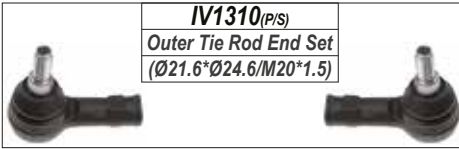

IV1310(P/S)
Outer Tie Rod End Set
(Ø21.6*Ø24.6/M20*1.5)

IV1010(P/S)
Outer Tie Rod End
(Ø21.6*Ø24.6/M20*1.5)



IV1011(M/S)
Outer Tie Rod End
(Ø18.1*Ø20.6/M16*1.5)

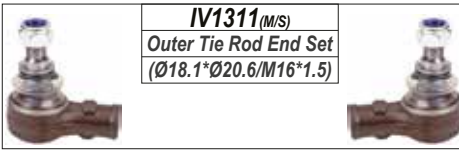

IV1311(M/S)
Outer Tie Rod End Set
(Ø18.1*Ø20.6/M16*1.5)

IV1011(M/S)
Outer Tie Rod End
(Ø18.1*Ø20.6/M16*1.5)



IV1410
Rack End
(16*1.5/16*1.5/330)



IV1610
Upper Ball Joint
(Ø21.1)



IV1610
Upper Ball Joint
(Ø21.1)



IV1710
Upper Control Arm

IV1711
Upper Control Arm

IV1911
Upper/Lower Ball Joint
(Ø21.35)



IV1911
Upper/Lower Ball Joint
(Ø21.35)



IV1910
Lower Ball Joint
(Ø17.9)



IV2110
Lower Control Arm Bush

IV1910
Lower Ball Joint
(Ø17.9)



IV2010
Lower Control Arm

IV2011
Lower Control Arm

LEFT

RIGHT

JAGUAR

S-TYPE

FRONT

ALL MODEL

Year

1999-2008

JA1010
Outer Tie Rod End
(Ø11.7*Ø25/M14*1.5)



JA1012
Outer Tie Rod End
(Ø13.5*Ø24/M14*1.5)



JA1010
Outer Tie Rod End
(Ø11.7*Ø25/M14*1.5)



JA1013
Outer Tie Rod End
(Ø13.5*Ø24/M14*1.5)



JA1410
Rack End
(16*1.5/14*1.5/209)



JA1510
Link Stabilizer
L=146

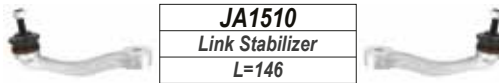

JA1511
Link Stabilizer
L=137

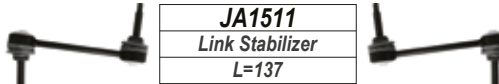

JA1710
Upper Control Arm

JA1711
Upper Control Arm

JA1910
Lower Ball Joint



JA1910
Lower Ball Joint



JA2810
Stabilizer Bar Bush



JA2010
Lower Control Arm

JA2011
Lower Control Arm

JA2810
Stabilizer Bar Bush



S-TYPE

REAR

JA1512
Link Stabilizer
L=522



JA1513 / JA1514
Link Stabilizer
L=223



LEFT

RIGHT

JAGUAR

X-TYPE

FRONT

ALL MODEL

Year

2001-2009

FO1018
Outer Tie Rod End
(Ø12.6*Ø16.1/M16*1.5)

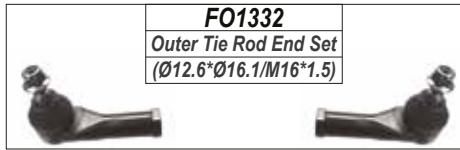

FO1332
Outer Tie Rod End Set
(Ø12.6*Ø16.1/M16*1.5)

JA1411
Rack End
(16*1.5/16*1.5/342)

FO1018
Outer Tie Rod End
(Ø12.6*Ø16.1/M16*1.5)



FO1530
Link Stabilizer
L=249

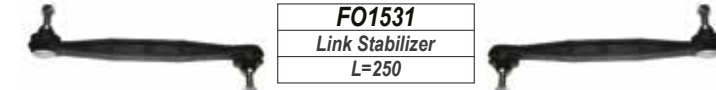

FO1531
Link Stabilizer
L=250

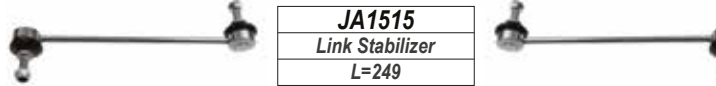

JA1515
Link Stabilizer
L=249

FO2133
Lower Control Arm Bush

FO1928
Lower Ball Joint
(Ø14.4)



FO1928
Lower Ball Joint
(Ø14.4)

FO2060
Lower Control Arm

FO2061
Lower Control Arm

FO2134
Lower Control Arm Bush

X-TYPE

REAR

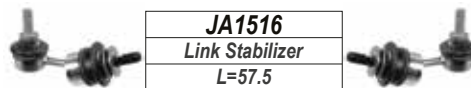

JA1516
Link Stabilizer
L=57.5

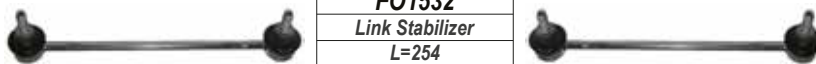

FO1532
Link Stabilizer
L=254

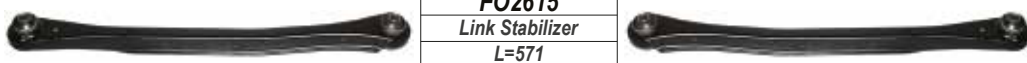

FO2615
Link Stabilizer
L=571

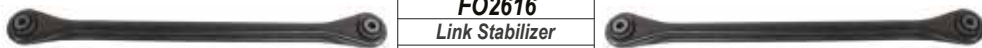

FO2616
Link Stabilizer
L=548.5

LEFT

RIGHT

JAGUAR

XF

FRONT

ALL MODEL

Year

2008-2015

JA1016
Outer Tie Rod End
(Ø14*2/Ø27/M14*1.5)



JA1412
Rack End
(16*1.5/14*1.5/225.5)



JA1017
Outer Tie Rod End
(Ø14*2/Ø27/M14*1.5)



JA1510
Link Stabilizer
L=146

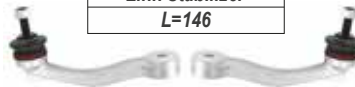

JA1712
Upper Control Arm

JA1713
Upper Control Arm

XF

REAR

JA1513 / JA1514
Link Stabilizer
L=223



LEFT

RIGHT

JAGUAR

XJ-XJS

FRONT

ALL MODEL

Year

1986-1994

JA1014
Outer Tie Rod End
(Ø13*Ø14.5/M14*1.5)

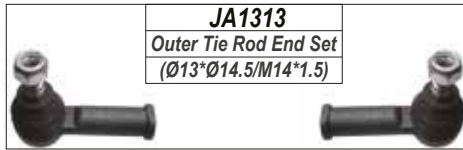

JA1313
Outer Tie Rod End Set
(Ø13*Ø14.5/M14*1.5)

JA1014
Outer Tie Rod End
(Ø13*Ø14.5/M14*1.5)

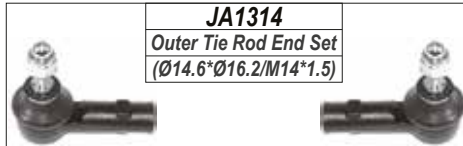

JA1314
Outer Tie Rod End Set
(Ø14.6*Ø16.2/M14*1.5)

JA1015
Outer Tie Rod End
(Ø14.6*Ø16.2/M14*1.5)



JA1413
Rack End
(14*1.5/295.5)

JA1015
Outer Tie Rod End
(Ø14.6*Ø16.2/M14*1.5)



JA1517
Link Stabilizer
L=115



JA1518
Link Stabilizer
L=139



JA1610
Upper Ball Joint
(Ø19.32)



JA1610
Upper Ball Joint
(Ø19.32)



JA1911
Lower Ball Joint
(Ø16.7)



JA1911
Lower Ball Joint
(Ø16.7)



LEFT

RIGHT

JAGUAR

XJ

FRONT

ALL MODEL

Year

2003-2010

JA1010
Outer Tie Rod End
(Ø11.7*Ø25/M14*1.5)

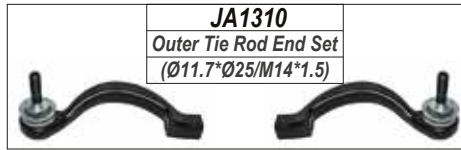

JA1410
Rack End
(16*1.5/14*1.5/209)



JA1010
Outer Tie Rod End
(Ø11.7*Ø25/M14*1.5)



JA1510
Link Stabilizer
L=146

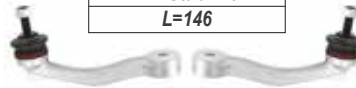

XJ

REAR

JA1513 / JA1514
Link Stabilizer
L=223



JA1519
Link Stabilizer
L=530



LEFT

RIGHT

JAGUAR

XJ

FRONT

ALL MODEL

Year

2010-

JA1016
Outer Tie Rod End
(Ø14*2/Ø27/M14*1.5)



JA1017
Outer Tie Rod End
(Ø14*2/Ø27/M14*1.5)



JA1510
Link Stabilizer
L=146

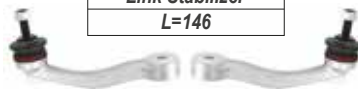

XJ

REAR

JA1513 / JA1514
Link Stabilizer
L=223



LEFT

RIGHT

JAGUAR

XK

FRONT

ALL MODEL

Year

2009-2015

JA1016
Outer Tie Rod End
(Ø14*2/Ø27/M14*1.5)



JA1412
Rack End
(16*1.5/14*1.5/225.5)



JA1017
Outer Tie Rod End
(Ø14*2/Ø27/M14*1.5)



JA1510
Link Stabilizer
L=146

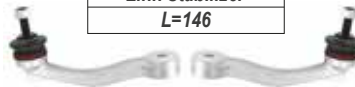

JA1710
Upper Control Arm

JA1711
Upper Control Arm

XK

REAR

JA1513 / JA1514
Link Stabilizer
L=223



JA1519
Link Stabilizer
L=530



LEFT

RIGHT

JEEP

CHEROKEE

FRONT

XJ.ZJ.I

Year

1984-2001

JE1010
Outer Tie Rod End (LHT)
(Ø15*Ø15.9/M17*1.5)



JE1011
Outer Tie Rod End
(Ø14.1*Ø15.8/M22*1.5)



JE1026
Outer Tie Rod End(RHT)
(Ø15*Ø15.9/M17*1.5)



JE1610
Upper Ball Joint
(Ø15.85)



JE1610
Upper Ball Joint
(Ø15.85)



JE1910
Lower Ball Joint
(Ø18.3)



JE1910
Lower Ball Joint
(Ø18.3)



LEFT

RIGHT

JEEP

CHEROKEE

FRONT

II.KJ

Year

2002-2008

JE1012
Outer Tie Rod End
(Ø14*Ø15.9/M16*1.5)

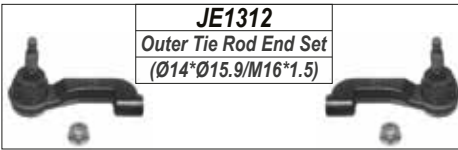

JE1312
Outer Tie Rod End Set
(Ø14*Ø15.9/M16*1.5)

JE1410
Rack End
(24*1.5/16*1.5/282)



JE1013
Outer Tie Rod End
(Ø14*Ø15.9/M16*1.5)

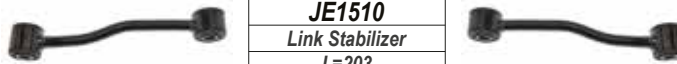

JE1510
Link Stabilizer
L=203



JE1710
Upper Control Arm

JE1710
Upper Control Arm

JE1911
Lower Ball Joint
(Ø17)



JE2010
Lower Control Arm

JE2011
Lower Control Arm

JE1911
Lower Ball Joint
(Ø17)



JE2810
Shock Mounting



JE2811
Shock Mounting



LEFT

RIGHT

JEEP

CHEROKEE

FRONT

KK

Year

2008-2014

DO1010
Outer Tie Rod End
(Ø15.5*Ø18.9/M16*1.5)



DO1310
Outer Tie Rod End Set
(Ø15.5*Ø18.9/M16*1.5)

DO1411
Rack End
(18*1.5/16*1.5/285.9)

DO1011
Outer Tie Rod End
(Ø15.5*Ø18.9/M16*1.5)



CR1513
Link Stabilizer
L=180.5



CR1514
Link Stabilizer
L=270

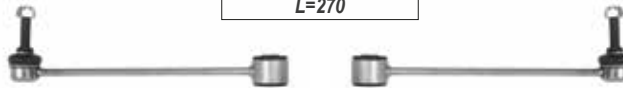

DO1913
Upper Control Arm

DO1914
Upper Control Arm

DO1912
Lower Ball Joint
(Ø17.25)



DO1912
Lower Ball Joint
(Ø17.25)

DO2012
Lower Control Arm

DO2013
Lower Control Arm

LEFT

RIGHT

JEEP

COMPASS

FRONT

2.0 CRD. 2.4. 2.0

Year

2007-2013

CR1011
Outer Tie Rod End
(Ø12.6*Ø16/M14*1.5)



CR1312
Outer Tie Rod End Set
(Ø12.6*Ø16/M14*1.5)

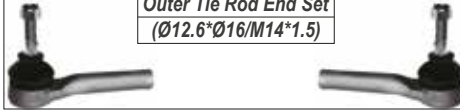

DO1410
Rack End
(14*1.5/14*1.5/298.5)



CR1011
Outer Tie Rod End
(Ø12.6*Ø16/M14*1.5)



CI1516
Link Stabilizer
L=265



JE2111
Lower Control Arm Bush



CI1910
Lower Ball Joint
(Ø20)



JE2012
Lower Control Arm



JE2013
Lower Control Arm

CI1910
Lower Ball Joint
(Ø20)



JE2110
Lower Control Arm Bush



DO2810
Shock Mounting



DO2810
Shock Mounting



LEFT

RIGHT

JEEP

GRAND CHEROKEE FRONT

WJ.2.7.3.1.4.0.4.7

Year

1998-2005

JE1014
Outer Tie Rod End
(Ø14.2*Ø15.95/M24*1.5)



JE1313
Outer Tie Rod End Set
(Ø14.2*Ø15.95/M24*1.5)

JE1015
Outer Tie Rod End
(Ø14.2*Ø15.95/M24*1.5)

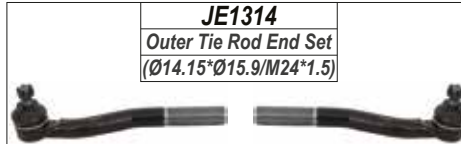

JE1314
Outer Tie Rod End Set
(Ø14.15*Ø15.9/M24*1.5)

JE1016
Outer Tie Rod End
(Ø14.15*Ø15.9/M24*1.5)



JE1017
Outer Tie Rod End
(Ø14.15*Ø15.9/M24*1.5)

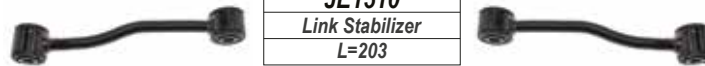

JE1510
Link Stabilizer
L=203

JE1614
Upper Ball Joint
(Ø15.85)



JE1713
Upper Control Arm

JE1713
Upper Control Arm

JE1614
Upper Ball Joint
(Ø15.85)



JE1912
Lower Ball Joint
(Ø17.6)



JE2014
Lower Control Arm

JE2014
Lower Control Arm

JE1912
Lower Ball Joint
(Ø17.6)



JE2812
Shock Mounting



JE2812
Shock Mounting



GRAND CHEROKEE REAR

JE2610
Lateral Link



JE1611
Upper Ball Joint
(Ø15.85)



JE1611
Upper Ball Joint
(Ø15.85)



LEFT

RIGHT

JEEP

GRAND CHEROKEE FRONT

WK.3.0CRD.3.7.4.7.5.7.6.1

Year

2005-2010

JE1018
Outer Tie Rod End
(Ø15*Ø19/M16*1.5)

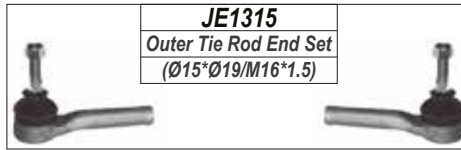

JE1315
Outer Tie Rod End Set
(Ø15*Ø19/M16*1.5)

JE1019
Outer Tie Rod End
(Ø15*Ø19/M16*1.5)



JE1511
Link Stabilizer
L=230



JE1512
Link Stabilizer
L=239.5



JE1612
Upper Ball Joint
(Ø14.5)



JE1712
Upper Control Arm

JE1712
Upper Control Arm

JE1612
Upper Ball Joint
(Ø14.5)



DO1912
Lower Ball Joint
(Ø17.25)



JE2015
Lower Control Arm

JE2016
Lower Control Arm

DO1912
Lower Ball Joint
(Ø17.25)



JE2812
Shock Mounting



JE2812
Shock Mounting



LEFT

RIGHT

JEEP

GRAND CHEROKEE FRONT

WK2.3.0CRD.3.6

Year

2011-

JE1316
Outer Tie Rod End Set
(Ø14.7*Ø18.3/M18*1.5)



JE1024
Outer Tie Rod End
(Ø14.7*Ø18.3/M18*1.5)



JE1411
Rack End
(16*1.5/18*1.5/218)



JE1025
Outer Tie Rod End
(Ø14.7*Ø18.3/M18*1.5)



JE1513 / JE1514
Link Stabilizer
L=132



JE1613
Upper Ball Joint
(Ø16.75)



JE1714
Upper Control Arm



JE1715
Upper Control Arm

JE1613
Upper Ball Joint
(Ø16.75)



JE1913
Lower Ball Joint
(Ø18)



JE2017
Lower Control Arm

JE2018
Lower Control Arm

JE1913
Lower Ball Joint
(Ø18)



JE2812
Shock Mounting



JE2812
Shock Mounting



LEFT

RIGHT

JEEP

PATRIOT

FRONT

2.0CRD.2.4

Year

2007-

CR1011
Outer Tie Rod End
(Ø12.6*Ø16/M14*1.5)

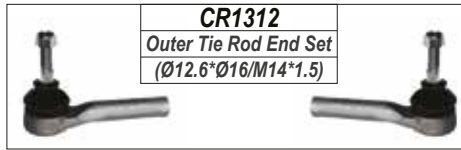

CR1312
Outer Tie Rod End Set
(Ø12.6*Ø16/M14*1.5)

DO1410
Rack End
(14*1.5/14*1.5/298)

CR1011
Outer Tie Rod End
(Ø12.6*Ø16/M14*1.5)



CI1516
Link Stabilizer
L=265



JE2111
Lower Control Arm Bush

DO1911
Lower Ball Joint
(Ø19.9)



JE2012
Lower Control Arm

JE2013
Lower Control Arm

DO1911
Lower Ball Joint
(Ø19.9)



JE2110
Lower Control Arm Bush



DO2810
Shock Mounting



DO2810
Shock Mounting



LEFT

RIGHT

JEEP

RENEGADE

FRONT

Year

ALL MODEL

2015-

JE1020
Outer Tie Rod End
(Ø11.7*Ø14.8/M14*1.5)



JE1021
Outer Tie Rod End
(Ø11.7*Ø14.8/M14*1.5)



FI1511
Link Stabilizer
L=280.5



FI2114
Lower Control Arm Bush

FI1911
Lower Ball Joint
(Ø18.9)



FI1911
Lower Ball Joint
(Ø18.9)

JE2019
Lower Control Arm

JE2020
Lower Control Arm

FI2115
Lower Control Arm Bush

RENEGADE

REAR

JE1515
Link Stabilizer
L=183.5



LEFT

RIGHT

JEEP

WRANGLER

FRONT

ALL MODEL

Year

2007-

JE1022
Outer Tie Rod End
(Ø16.55*Ø18.8/M14*1.5)



JE1023
Outer Tie Rod End
(Ø16.55*Ø18.8/M14*1.5)



JE1614
Upper Ball Joint
(Ø15.85)



JE1912
Lower Ball Joint
(Ø17.6)

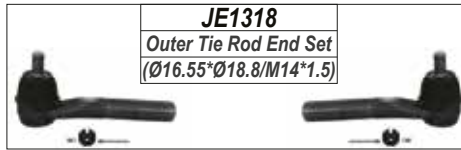

JE1318
Outer Tie Rod End Set
(Ø16.55*Ø18.8/M14*1.5)

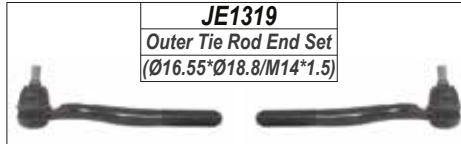

JE1319
Outer Tie Rod End Set
(Ø16.55*Ø18.8/M14*1.5)

JE1022
Outer Tie Rod End
(Ø16.55*Ø18.8/M14*1.5)



JE1023
Outer Tie Rod End
(Ø16.55*Ø18.8/M14*1.5)



JE1516
Link Stabilizer
L=130



JE1614
Upper Ball Joint
(Ø15.85)



JE1912
Lower Ball Joint
(Ø17.6)



JE2510
Pitman Arm



WRANGLER

REAR

JE1517
Link Stabilizer
L=280.5



JE2611
Lateral Link



JE2612
Lateral Link



JE2613
Lateral Link



JE2614
Lateral Link



LEFT RIGHT

KIA

CARENS

FRONT

Year

2002-2006

II

KI1010
Outer Tie Rod End
(Ø12.5*Ø14.4/M14*1.5)

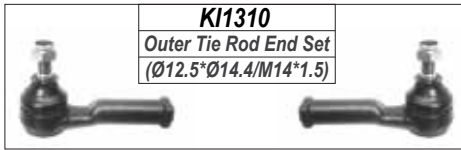

KI1310
Outer Tie Rod End Set
(Ø12.5*Ø14.4/M14*1.5)

KI1010
Outer Tie Rod End
(Ø12.5*Ø14.4/M14*1.5)

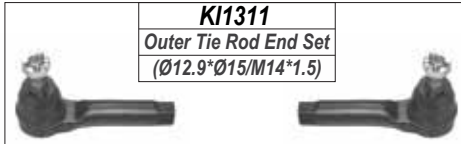

KI1311
Outer Tie Rod End Set
(Ø12.9*Ø15/M14*1.5)

KI1011
Outer Tie Rod End
(Ø12.9*Ø15/M14*1.5)



KI1421
Rack End
(16*1.5/14*1.5/287)

KI1011
Outer Tie Rod End
(Ø12.9*Ø15/M14*1.5)



KI1510 / KI1511
Link Stabilizer
L=280



KI1910
Lower Ball Joint
(Ø18)



KI2010
Lower Control Arm



KI2011
Lower Control Arm



KI1910
Lower Ball Joint
(Ø18)



CARENS

REAR

KI1512
Link Stabilizer
L=90.5



LEFT

RIGHT

KIA

CARENS

FRONT

Year

2006-

///

KI1027
Outer Tie Rod End
(Ø13.4*Ø15.1/M16*1.5)



KI1312
Outer Tie Rod End Set
(Ø13.4*Ø15.1/M16*1.5)



KI1410
Rack End
(18*1.5/16*1.5/193)



KI1028
Outer Tie Rod End
(Ø13.4*Ø15.1/M16*1.5)



KI1510 / KI1511
Link Stabilizer
L=280



KI1562
Link Stabilizer
L=241



KI2117
Lower Control Arm Bush



HY1926
Lower Ball Joint
(Ø15.1)

HY1926
Lower Ball Joint
(Ø15.1)

KI2012
Lower Control Arm

KI2013
Lower Control Arm

KI2118
Lower Control Arm Bush

CARENS

REAR

KI1513
Link Stabilizer
L=180



LEFT

RIGHT

KIA

CARNIVAL

FRONT

II

Year

2000-2005

KI1012
Outer Tie Rod End
(Ø13.75*Ø16/M14*1.5)



KI1411
Rack End
(18*1.5/14*1.5/241)



KI1412
Rack End
(17*1.0/14*1.5/307)



KI1013
Outer Tie Rod End
(Ø13.75*Ø16/M14*1.5)

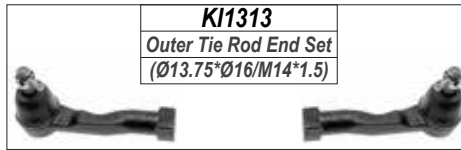

KI1514
Link Stabilizer
L=64



KI2014
Lower Control Arm



KI2015
Lower Control Arm

LEFT

RIGHT

KIA

CERATO

FRONT

ALL MODEL

Year

2004-2009

HY1010
Outer Tie Rod End
(Ø13.3*Ø15/M14*1.5)



HY1310
Outer Tie Rod End Set
(Ø13.3*Ø15/M14*1.5)



HY1417
Rack End
(16*1.5/14*1.5/327)



HY1010
Outer Tie Rod End
(Ø13.3*Ø15/M14*1.5)



KI1515
Link Stabilizer
L=250



HY1917
Lower Ball Joint
(Ø15)



KI2016
Lower Control Arm

KI2017
Lower Control Arm

HY1917
Lower Ball Joint
(Ø15)



KI2810
Shock Mounting



KI2810
Shock Mounting



CERATO

REAR

KI1516
Link Stabilizer
L=129



HY1520
Link Stabilizer
L=130



LEFT

RIGHT

KIA
CERATO

FRONT

ALL MODEL

Year

2009-

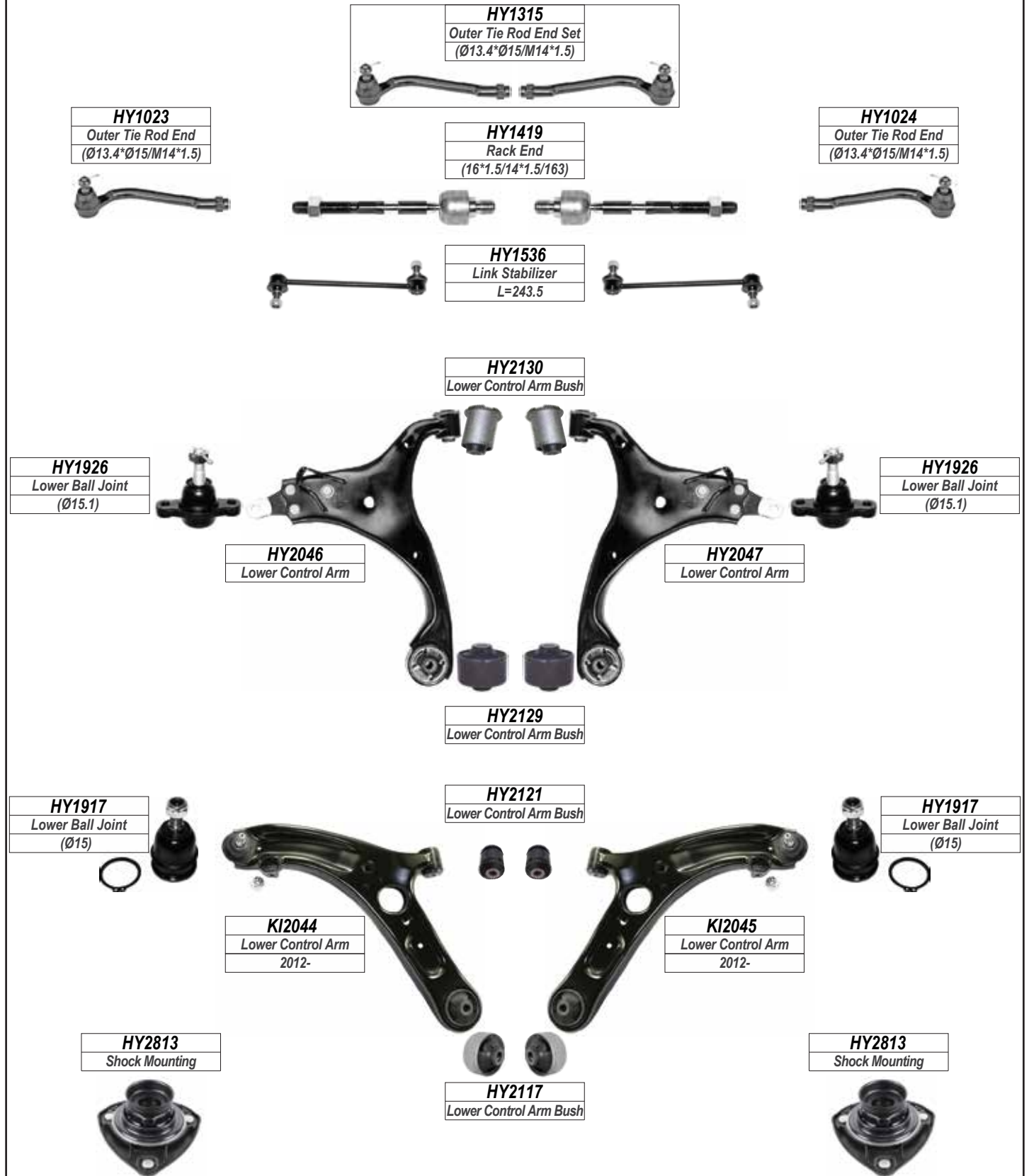

LEFT

RIGHT

KIA

CLARUS

FRONT

ALL MODEL

Year

1998-2001

KI1010
Outer Tie Rod End
(Ø12.5*Ø14.4/M14*1.5)

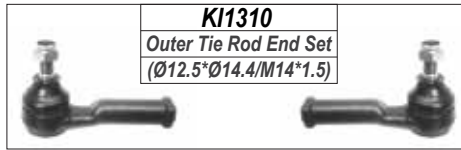

KI1010
Outer Tie Rod End
(Ø12.5*Ø14.4/M14*1.5)

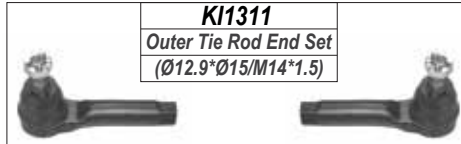

KI1011
Outer Tie Rod End
(Ø12.9*Ø15/M14*1.5)



KI1422
Rack End
(16*1.5/14*1.5/285)

KI1011
Outer Tie Rod End
(Ø12.9*Ø15/M14*1.5)



KI1510 / KI1511
Link Stabilizer
L=280



FO1932
Lower Ball Joint
(Ø18)



FO1932
Lower Ball Joint
(Ø18)



CLARUS

REAR

KI1512
Link Stabilizer
L=90.5



LEFT

RIGHT

KIA

K2700. K2500

FRONT

ALL MODEL

Year

2004-

FO1335

Outer Tie Rod End Set
(Ø14*Ø16/M14*1.5)

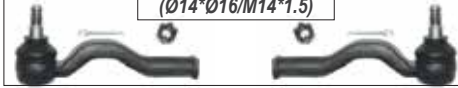

FO1019

Outer Tie Rod End
(Ø14*Ø16/M14*1.5)



FO1417

Rack End
(17*1.0/14*1.5/182 (Man))



FO1019

Outer Tie Rod End
(Ø14*Ø16/M14*1.5)



KI1423

Rack End
(18*1.5/14*1.5/183 (Pow))



FO1612

Upper Ball Joint
(Ø17.85)



FO1718

Upper Control Arm



FO1719

Upper Control Arm

FO1612

Upper Ball Joint
(Ø17.85)



KI1716

Upper Control Arm
2012-



KI1717

Upper Control Arm
2012-

FO1931

Lower Ball Joint
(Ø19.75)



KI2018

Lower Control Arm



KI2019

Lower Control Arm

FO1931

Lower Ball Joint
(Ø19.75)



LEFT

RIGHT

KIA

MAGENTIS

FRONT

ALL MODEL

Year

2004-2007

HY1041
Outer Tie Rod End
(Ø13.45*Ø15/M14*1.5)



HY1329
Outer Tie Rod End Set
(Ø13.45*Ø15/M14*1.5)

HY1433
Rack End
(16*1.5/14*1.5/170)



HY1042
Outer Tie Rod End
(Ø13.45*Ø15/M14*1.5)



HY1552
Link Stabilizer
L=102.5



HY1613
Upper Ball Joint
(Ø13.4)



HY1712
Upper Control Arm

HY1713
Upper Control Arm

HY1613
Upper Ball Joint
(Ø13.4)



HY1930
Lower Ball Joint
(Ø18.1)



HY2135
Lower Control Arm Bush



HY2060
Lower Control Arm

HY2061
Lower Control Arm

HY1930
Lower Ball Joint
(Ø18.1)



HY2134
Lower Control Arm Bush



KI1517
Link Stabilizer
L=60

MAGENTIS

REAR

LEFT

RIGHT

KIA

OPTIMA

FRONT

ALL MODEL

Year

2012-

HY1035
Outer Tie Rod End
(Ø13.4*Ø15/M16*1.5)



HY1326
Outer Tie Rod End Set
(Ø13.4*Ø15/M16*1.5)

HY1432
Rack End
(16*1.5/16*1.5/192)



HY1036
Outer Tie Rod End
(Ø13.4*Ø15/M16*1.5)



HY1557 / HY1558
Link Stabilizer
L=351.5



HY1565
Link Stabilizer
L=270



HY1927
Lower Ball Joint
(Ø18)



KI2110
Lower Control Arm Bush



HY1927
Lower Ball Joint
(Ø18)



HY2064
Lower Control Arm

HY2065
Lower Control Arm

HY2133
Lower Control Arm Bush

HY2820
Shock Mounting



HY2820
Shock Mounting



LEFT

RIGHT

KIA

PICANTO

FRONT

ALL MODEL

Year

2004-2011

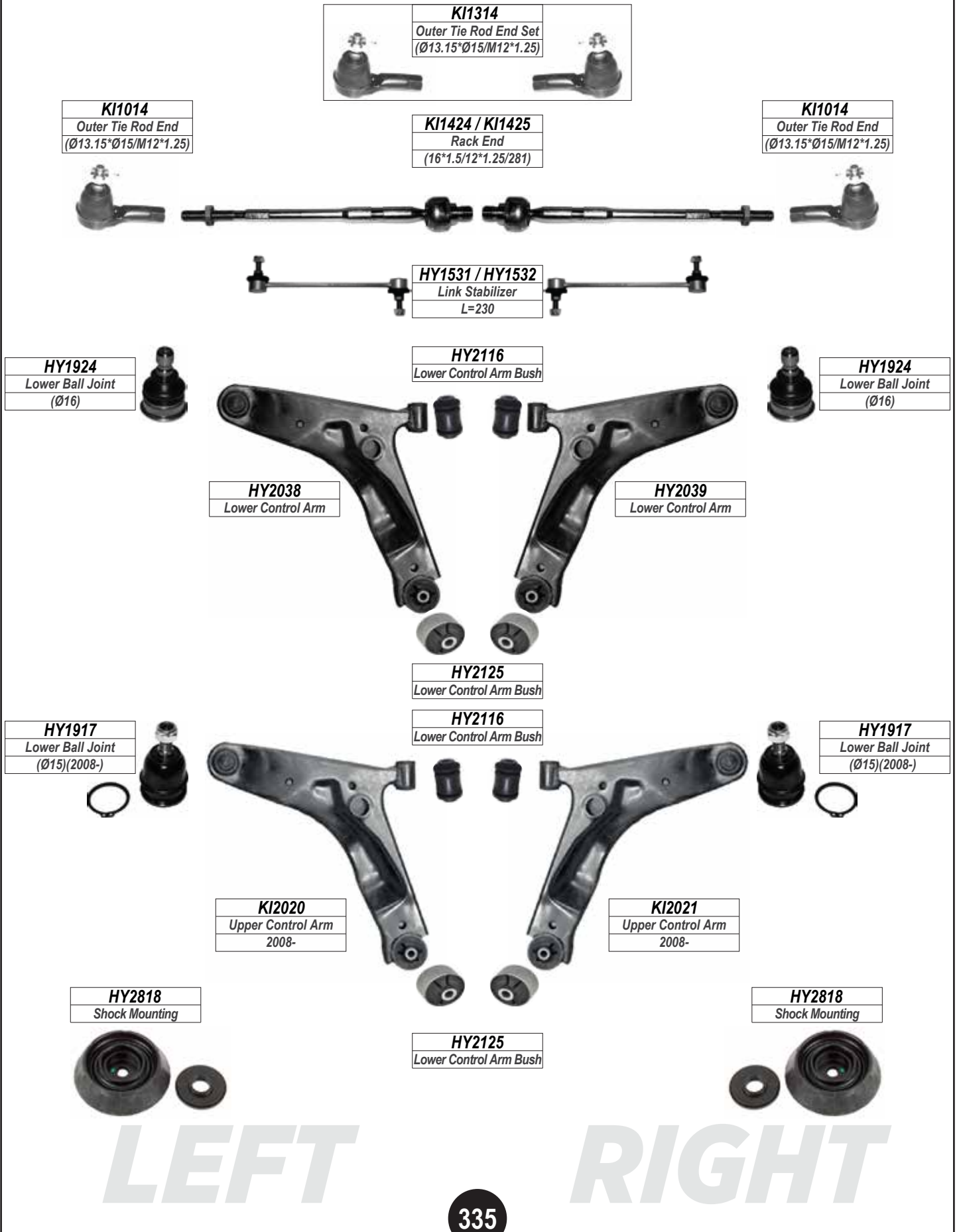

KIA

PICANTO

FRONT

ALL MODEL

Year

2011-

KI1015 (P/S)
Outer Tie Rod End
(Ø13.25*Ø15/M14*1.5)



KI1315 (P/S)
Outer Tie Rod End Set
(Ø13.25*Ø15/M14*1.5)

KI1413 (P/S)
Rack End
(20*1.5/14*1.25/198)



KI1016 (P/S)
Outer Tie Rod End
(Ø13.25*Ø15/M14*1.5)



KI1415 (P/S)
Rack End(2015-)
(16*1.5/14*1.5/212)

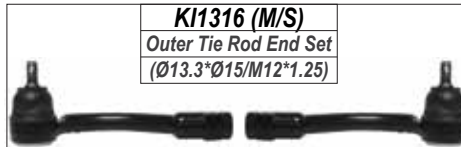

KI1316 (M/S)
Outer Tie Rod End Set
(Ø13.3*Ø15/M12*1.25)

KI1017 (M/S)
Outer Tie Rod End
(Ø13.3*Ø15/M12*1.25)



KI1414 (M/S)
Rack End
(14*1.5/12*1.25/218)



KI1018 (M/S)
Outer Tie Rod End
(Ø13.3*Ø15/M12*1.25)



HY1533 / HY1534
Link Stabilizer
L=216



HY1925
Lower Ball Joint
(Ø18)



KI2022
Lower Control Arm

KI2023
Lower Control Arm

HY1925
Lower Ball Joint
(Ø18)



HY2819
Shock Mounting



HY2819
Shock Mounting



LEFT

RIGHT

KIA

PICANTO

FRONT

ALL MODEL

Year

2017-

KI1323

Outer Tie Rod End Set
(Ø13.3*Ø15/M14*1.5)

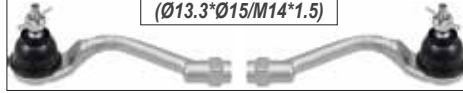

KI1030

Outer Tie Rod End
(Ø13.3*Ø15/M14*1.5)



KI1434

Rack End
(16*1.5/14*1.5/219)



KI1031

Outer Tie Rod End
(Ø13.3*Ø15/M14*1.5)



KI1539

Link Stabilizer
L=250



KI1916

Lower Ball Joint
(Ø18)



KI2046

Lower Control Arm



KI2047

Lower Control Arm

KI1916

Lower Ball Joint
(Ø18)



LEFT

RIGHT

KIA

PREGIO

FRONT

ALL MODEL

Year

2001-2004

KI1029
Outer Tie Rod End
(Ø13.8*Ø15/M14*1.5)

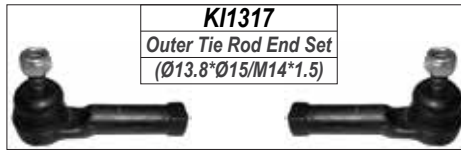

KI1317
Outer Tie Rod End Set
(Ø13.8*Ø15/M14*1.5)

KI1426
Rack End
(17*1.0/14*1.5/275)

KI1029
Outer Tie Rod End
(Ø13.8*Ø15/M14*1.5)



KI1518
Link Stabilizer
L=77



KI1519
Link Stabilizer
L=145.5

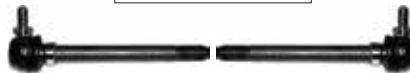

KI1710
Upper Control Arm



KI1711
Upper Control Arm



KI1712
Upper Control Arm



KI1712
Upper Control Arm



KI1911
Lower Ball Joint
(Ø21.6)



KI1911
Lower Ball Joint
(Ø21.6)



LEFT

RIGHT

KIA

PRIDE

FRONT

ALL MODEL

Year

1998-2000

FO1029
Outer Tie Rod End
(Ø13.2*Ø15.1/M12*1.25)

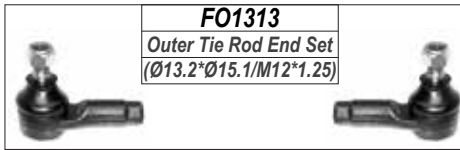

FO1313
Outer Tie Rod End Set
(Ø13.2*Ø15.1/M12*1.25)

KI1427
Rack End
(16*1.5/12*1.25/265)

FO1029
Outer Tie Rod End
(Ø13.2*Ø15.1/M12*1.25)



KI2024
Lower Control Arm



KI2024
Lower Control Arm

LEFT

RIGHT

KIA

RIO

FRONT

I

Year

2000-2005

KI1014
Outer Tie Rod End
(Ø13.15*Ø15/M12*1.25)

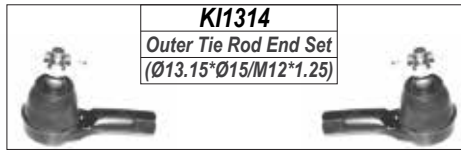

KI1314
Outer Tie Rod End Set
(Ø13.15*Ø15/M12*1.25)

KI1428
Rack End
(16*1.5/12*1.25/280)

KI1014
Outer Tie Rod End
(Ø13.15*Ø15/M12*1.25)



KI1429
Rack End
(16*1.5/12*1.25/281)



KI1520 / KI1521
Link Stabilizer
L=240



KI1522 / KI1523
Link Stabilizer
L=218



KI2116
Lower Control Arm Bush

KI2025
Lower Control Arm
2000-2003

KI2026
Lower Control Arm
2000-2003



KI2116
Lower Control Arm Bush

KI2027
Lower Control Arm
2003-2005

KI2028
Lower Control Arm
2003-2005

KI2812
Shock Mounting



KI2812
Shock Mounting



KI2813
Shock Mounting



KI2814
Shock Mounting



LEFT

RIGHT

KIA

RIO

FRONT

II

Year

2005-2008

KI1019
Outer Tie Rod End
(Ø13.3*Ø15/M14*1.5)



KI1318
Outer Tie Rod End Set
(Ø13.3*Ø15/M14*1.5)

KI1416
Rack End
(16*1.5/14*1.5/190)



KI1020
Outer Tie Rod End
(Ø13.3*Ø15/M14*1.5)



HY1515 / HY1516
Link Stabilizer
L=285



HY2116
Lower Control Arm Bush



HY1918
Lower Ball Joint
(Ø15)



HY2014
Lower Control Arm

HY2015
Lower Control Arm

HY1918
Lower Ball Joint
(Ø15)



HY2115
Lower Control Arm Bush



HY2813
Shock Mounting



HY2813
Shock Mounting



LEFT

RIGHT

KIA

RIO

FRONT

III

Year

2011-

HY1021
Outer Tie Rod End
(Ø13.25*Ø17/M16*1.5)



HY1312
Outer Tie Rod End Set
(Ø13.25*Ø17/M16*1.5)

HY1415
Rack End
(16*1.5/16*1.5/218)



HY1022
Outer Tie Rod End
(Ø13.25*Ø17/M16*1.5)



KI1015
Outer Tie Rod End
(Ø13.25*Ø15/M14*1.5)



KI1315
Outer Tie Rod End Set
(Ø13.25*Ø15/M14*1.5)

HY1437
Rack End
(14*1.5/14*1.5/219)



KI1016
Outer Tie Rod End
(Ø13.25*Ø15/M14*1.5)



HY1517
Link Stabilizer
L=282.5



HY1925
Lower Ball Joint
(Ø18)



HY2116
Lower Control Arm Bush



KI2029
Lower Control Arm

KI2030
Lower Control Arm

HY1925
Lower Ball Joint
(Ø18)



HY2115
Lower Control Arm Bush



HY2819
Shock Mounting



HY2819
Shock Mounting



LEFT

RIGHT

KIA

SEDONA

FRONT

ALL MODEL

Year

2007-

KI1021
Outer Tie Rod End
(Ø13.8*Ø16/M16*1.5)

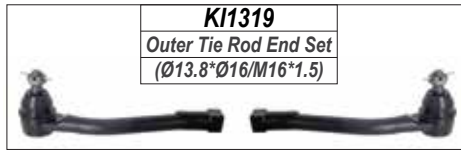

KI1319
Outer Tie Rod End Set
(Ø13.8*Ø16/M16*1.5)

KI1417
Rack End
(16*1.5/16*1.5/212)



KI1022
Outer Tie Rod End
(Ø13.8*Ø16/M16*1.5)



KI1524 / KI1525
Link Stabilizer
L=285



HY2140
Lower Control Arm Bush



HY1921
Lower Ball Joint
(Ø20)



HY1921
Lower Ball Joint
(Ø20)



KI2041
Lower Control Arm



KI2042
Lower Control Arm



HY2139
Lower Control Arm Bush



HY2817
Shock Mounting



HY2817
Shock Mounting



LEFT

RIGHT

KIA

SEPHIA

FRONT

Year

ALL MODEL

1998-2001

KI1011
Outer Tie Rod End
(Ø12.9*Ø15/M14*1.5)

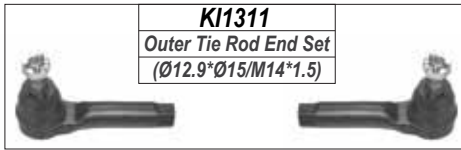

KI1430
Rack End
(16*1.5/14*1.5/277)

KI1011
Outer Tie Rod End
(Ø12.9*Ø15/M14*1.5)



F01912
Lower Ball Joint
(Ø16)



F01912
Lower Ball Joint
(Ø16)

KI2815
Shock Mounting



KI2815
Shock Mounting



LEFT

RIGHT

KIA

SHUMA

FRONT

ALL MODEL

Year

1998-2004

KI1011
Outer Tie Rod End
(Ø12.9*Ø15/M14*1.5)

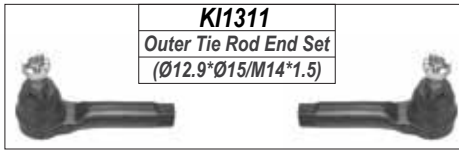

KI1311
Outer Tie Rod End Set
(Ø12.9*Ø15/M14*1.5)

KI1431
Rack End
(16*1.5/14*1.5/293)

KI1011
Outer Tie Rod End
(Ø12.9*Ø15/M14*1.5)



KI1526 / KI1527
Link Stabilizer
L=274



KI1528
Link Stabilizer
L=85



FO1912
Lower Ball Joint
(Ø16)



FO1912
Lower Ball Joint
(Ø16)

KI1910
Lower Ball Joint
(Ø18)



KI1910
Lower Ball Joint
(Ø18)

KI2815
Shock Mounting



KI2815
Shock Mounting



LEFT

RIGHT

KIA

SORENTO

FRONT

ALL MODEL

Year

2003-2009

KI1023
Outer Tie Rod End
(Ø13.85*Ø16.1/M14*1.5)

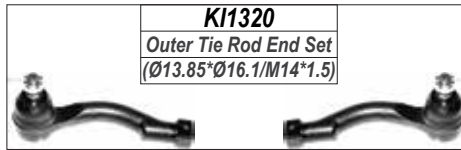

KI1320
Outer Tie Rod End Set
(Ø13.85*Ø16.1/M14*1.5)

KI1432
Rack End
(18*1.5/14*1.5/172)



KI1024
Outer Tie Rod End
(Ø13.85*Ø16.1/M14*1.5)



KI1529
Link Stabilizer
L=149.5



KI1530 / KI1531
Link Stabilizer
L=85



KI1713
Upper Control Arm

KI1714
Upper Control Arm

KI1810
Upper Control Arm Bush

KI2031
Lower Control Arm

KI2032
Lower Control Arm

KI1913
Lower Ball Joint
(Ø21.7)



KI2111
Lower Control Arm Bush

KI1913
Lower Ball Joint
(Ø21.7)

KI2112
Lower Control Arm Bush

KI2112
Lower Control Arm Bush

KI2816
Shock Mounting



KI2816
Shock Mounting



SORENTO

REAR

KI1532 / KI1533
Link Stabilizer
L=120



LEFT

RIGHT

KIA

SORENTO

FRONT

ALL MODEL

Year

2009-2014

HY1037
Outer Tie Rod End
(Ø13.9*Ø16/M16*1.5)

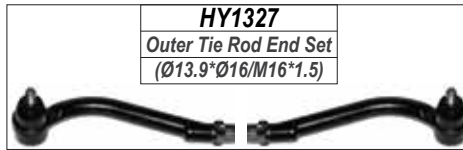

HY1327
Outer Tie Rod End Set
(Ø13.9*Ø16/M16*1.5)

KI1418 / KI1419
Rack End
(18*1.5/16*1.5/172)



HY1038
Outer Tie Rod End
(Ø13.9*Ø16/M16*1.5)



HY1546 / HY1547
Link Stabilizer
L=341



KI1534 / KI1535
Link Stabilizer
L=85



HY1929
Lower Ball Joint
(Ø20)



HY2139
Lower Control Arm Bush

KI2039
Lower Control Arm

HY2140
Lower Control Arm Bush

KI2040
Lower Control Arm

HY1929
Lower Ball Joint
(Ø20)



KI2817
Shock Mounting



KI2817
Shock Mounting



LEFT

RIGHT

KIA

SORENTO

FRONT

ALL MODEL

Year

2015-

HY1047
Outer Tie Rod End
(Ø13.85*Ø16.1/M14*1.5)



HY1332
Outer Tie Rod End Set
(Ø13.85*Ø16.1/M14*1.5)

KI1420
Rack End
(16*1.5/14*1.5/242.5)



HY1048
Outer Tie Rod End
(Ø13.85*Ø16.1/M14*1.5)



KI1914
Lower Ball Joint
(Ø18)



KI2033
Lower Control Arm

KI2034
Lower Control Arm

KI1914
Lower Ball Joint
(Ø18)



LEFT

RIGHT

KIA

SOUL

FRONT

AM

Year

2009-2014

HY1017
Outer Tie Rod End
(Ø13.4*Ø15.1/M16*1.5)

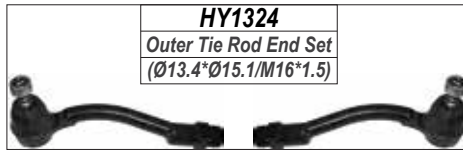

HY1324
Outer Tie Rod End Set
(Ø13.4*Ø15.1/M16*1.5)

KI1433
Rack End
(16*1.5/16*1.5/247)



HY1018
Outer Tie Rod End
(Ø13.4*Ø15.1/M16*1.5)



KI1536 / KI1537
Link Stabilizer
L=216



KI2037
Upper Control Arm
With Bracket



KI2038
Upper Control Arm
With Bracket

KI2114
Lower Control Arm Bush



KI2035
Lower Control Arm

KI2036
Lower Control Arm

KI2113
Lower Control Arm Bush



HY1925
Lower Ball Joint
(Ø20)



HY1925
Lower Ball Joint
(Ø20)



KI2818
Shock Mounting



KI2818
Shock Mounting



LEFT

RIGHT

KIA

SPORTAGE

FRONT

ALL MODEL

Year

1999-2005

KI1321

Outer Tie Rod End Set
(Ø13.1*Ø15/M18*1.5)

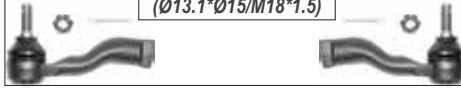

KI1322

Inner Tie Rod End Set
(Ø14.6*Ø16/M18*1.5)



KI1025

Outer Tie Rod End
(Ø13.1*Ø15/M18*1.5)



KI1110 / KI1111

Inner Tie Rod End
(Ø14.6*Ø16/M18*1.5)



KI1026

Outer Tie Rod End
(Ø13.1*Ø15/M18*1.5)



KI1210 / KI1211

Tie Rod End Assembly



KI1519

Link Stabilizer
L=145.5

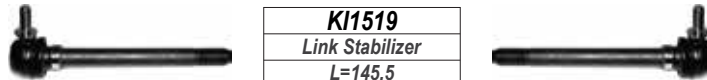

KI1715

Upper Control Arm



KI1715

Upper Control Arm

KI1915

Lower Ball Joint
(Ø17.8)



KI1915

Lower Ball Joint
(Ø17.8)



KI2819

Shock Mounting



KI2043

Lower Control Arm



KI2043

Lower Control Arm



KI2819

Shock Mounting



LEFT

RIGHT

KIA

SPORTAGE

FRONT

ALL MODEL

Year

2005-2010

HY1045
Outer Tie Rod End
(Ø13.45*Ø15/M16*1.5)



HY1331
Outer Tie Rod End Set
(Ø13.45*Ø15/M16*1.5)

HY1435
Rack End
(16*1.5/16*1.5/241)

HY1046
Outer Tie Rod End
(Ø13.45*Ø15/M16*1.5)



HY1510
Link Stabilizer
L=238



HY2130
Lower Control Arm Bush



HY1932
Lower Ball Joint
(Ø14.55)



HY1932
Lower Ball Joint
(Ø14.55)



HY2066
Lower Control Arm

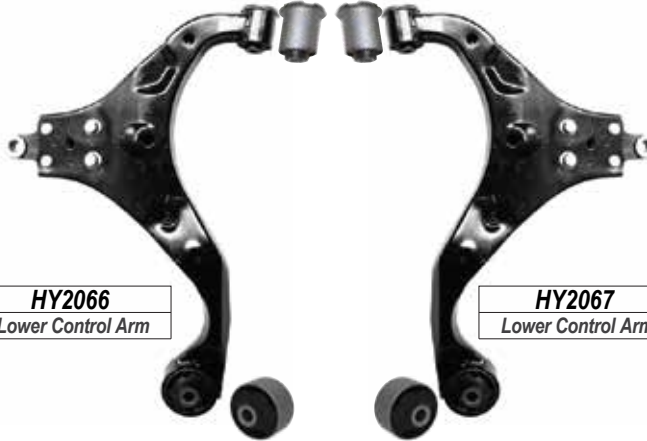

HY2067
Lower Control Arm

KI2115
Lower Control Arm Bush



SORENTO

REAR

HY1563
Link Stabilizer
L=219



LEFT

RIGHT

KIA

SPORTAGE

FRONT

ALL MODEL

Year

2010-2015

HY1035
Outer Tie Rod End
(Ø13.4*Ø15/M16*1.5)



HY1326
Outer Tie Rod End Set
(Ø13.4*Ø15/M16*1.5)

HY1429
Rack End
(16*1.5/16*1.5/183)



HY1036
Outer Tie Rod End
(Ø13.4*Ø15/M16*1.5)



HY1539
Link Stabilizer
L=267



HY2132
Lower Control Arm Bush

HY1928
Lower Ball Joint
(Ø18)



HY2050
Lower Control Arm

HY2051
Lower Control Arm

HY1928
Lower Ball Joint
(Ø18)



HY2822
Shock Mounting



HY2133
Lower Control Arm Bush



HY2822
Shock Mounting



SPORTAGE

REAR

HY1541
Link Stabilizer
L=140



HY2823
Shock Mounting



KI1538
Link Stabilizer
L=90



HY2823
Shock Mounting



LEFT

RIGHT

KIA

SPORTAGE

FRONT

ALL MODEL

Year

2015-

HY1047
Outer Tie Rod End
(Ø13.85*Ø16.1/M14*1.5)



HY1332
Outer Tie Rod End Set
(Ø13.85*Ø16.1/M14*1.5)

HY1436
Rack End
(16*1.5/14*1.5/242.5)



HY1048
Outer Tie Rod End
(Ø13.85*Ø16.1/M14*1.5)



HY1535
Link Stabilizer
L=282.5



HY1915
Lower Ball Joint
(Ø18)



HY2068
Lower Control Arm

HY2069
Lower Control Arm

HY1916
Lower Ball Joint
(Ø18)



SPORTAGE

REAR

HY1564
Link Stabilizer
L=140



LEFT

RIGHT

LAND ROVER

DEFENDER

FRONT

ALL MODEL

Year

1996-2007

LR2210

Center Rod



LR1310

Outer Tie Rod End Set
(Ø15*Ø17.5/M12*1.5)

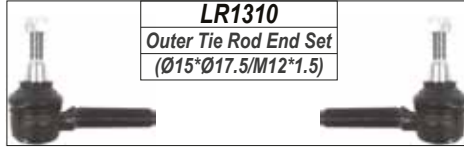

LR1010

Outer Tie Rod End
(Ø15*Ø17.5/M12*1.5)



LR1011

Outer Tie Rod End
(Ø15*Ø17.5/M12*1.5)



LR1510

Link Stabilizer
L=64



LR1910

Lower Ball Joint
(Ø23)



LR1910

Lower Ball Joint
(Ø23)



DEFENDER

REAR

LR1911

Lower Ball Joint
(Ø20)



LR1911

Lower Ball Joint
(Ø20)



LEFT

RIGHT

LAND ROVER

DISCOVERY

FRONT

Year

1990-1999

LR2211
Center Road
L=1320



LR2212
Center Road
L=940



LR2213
Center Road
L=920

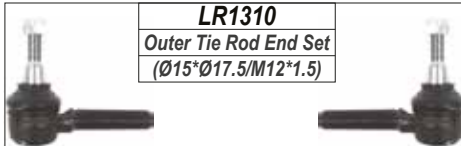
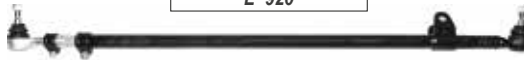

LR1310
Outer Tie Rod End Set
(Ø15*Ø17.5/M12*1.5)

LR1010
Outer Tie Rod End
(Ø15*Ø17.5/M12*1.5)



LR1011
Outer Tie Rod End
(Ø15*Ø17.5/M12*1.5)



LR1510
Link Stabilizer
L=64



LR1511
Link Stabilizer
L=170



LR1910
Lower Ball Joint
(Ø23)



LR1910
Lower Ball Joint
(Ø23)



LR1911
Lower Ball Joint
(Ø20)



LR1911
Lower Ball Joint
(Ø20)



LEFT

RIGHT

LAND ROVER

DISCOVERY

FRONT

II

Year

1999-2005

LR2211
Center Road
L=1320



LR2212
Center Road
L=940



LR2213
Center Road
L=920

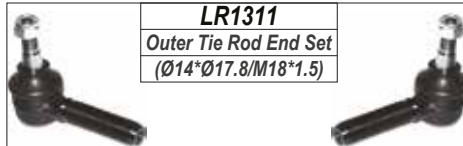
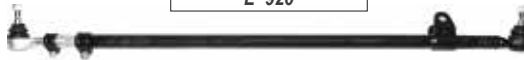

LR1311
Outer Tie Rod End Set
(Ø14*Ø17.8/M18*1.5)

LR1012
Outer Tie Rod End
(Ø14*Ø17.8/M18*1.5)



LR1013
Outer Tie Rod End
(Ø14*Ø17.8/M18*1.5)



LR1512
Link Stabilizer
L=217.5



LR1610
Upper Ball Joint
(Ø15.8)



LR1610
Upper Ball Joint
(Ø15.8)



LR1910
Lower Ball Joint
(Ø19.6)



LR1910
Lower Ball Joint
(Ø19.6)



LEFT

RIGHT

LAND ROVER

DISCOVERY

FRONT

III . IV

Year

2005-

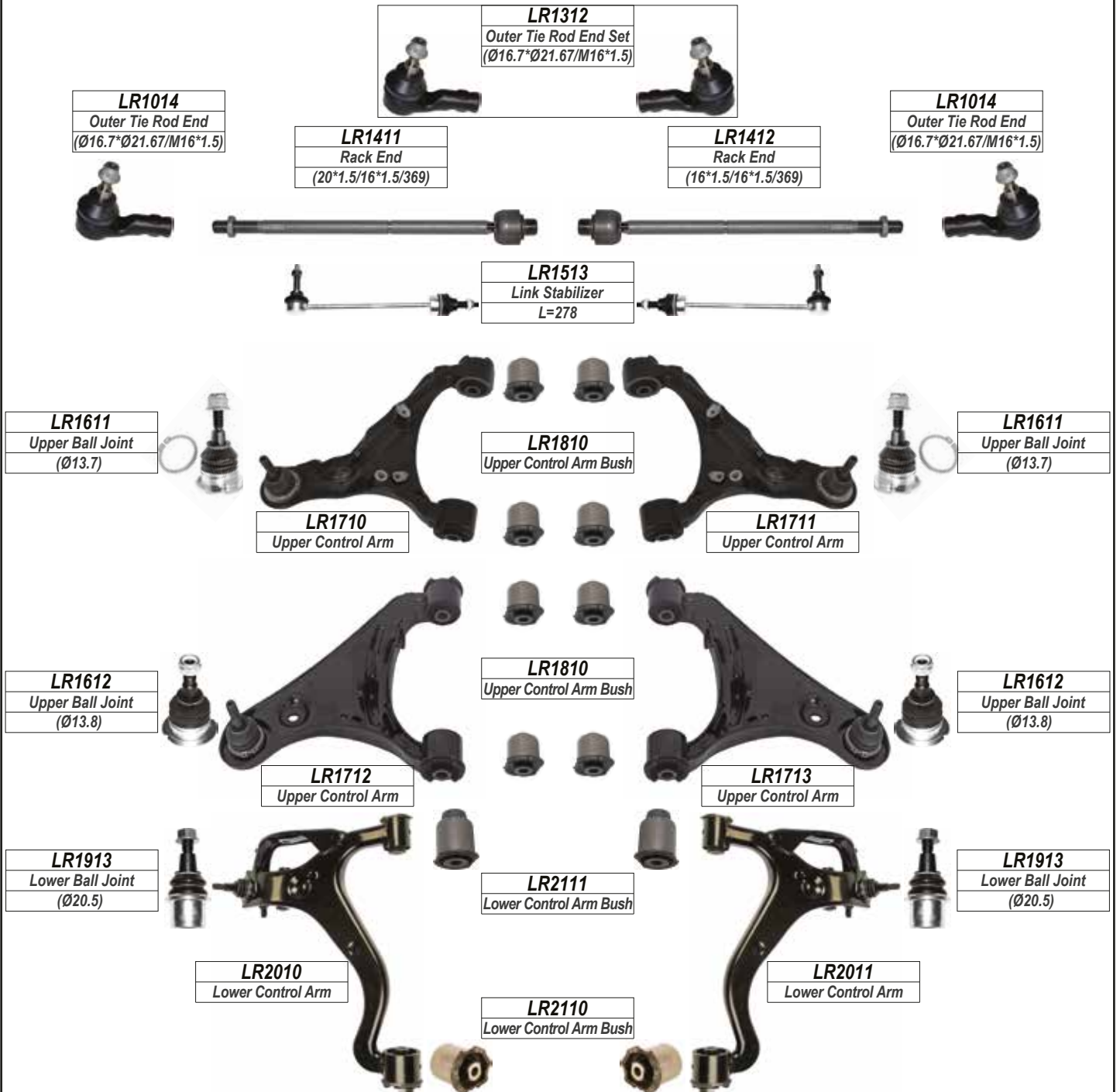

DISCOVERY

REAR

LR2610
Lateral Link

LR2910
Bush
(ID=Ø14/OD=Ø76.3)

LR1514
Link Stabilizer
L=116

LR2910
Bush
(ID=Ø14/OD=Ø76.3)

LR2911
Bush
(ID=Ø13.2/OD=Ø47.3)

LEFT

RIGHT

LAND ROVER

DISCOVERY

FRONT

V (L462)

Year

2016-

LR1024
Outer Tie Rod End
(Ø16.55*Ø22.9/M16*1.5)

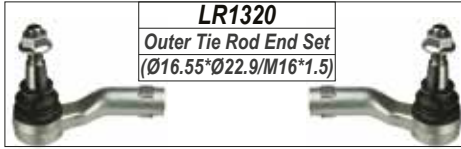

LR1320
Outer Tie Rod End Set
(Ø16.55*Ø22.9/M16*1.5)

LR1416
Rack End
(20*1.5/16*1.5/369)

LR1024
Outer Tie Rod End
(Ø16.55*Ø22.9/M16*1.5)

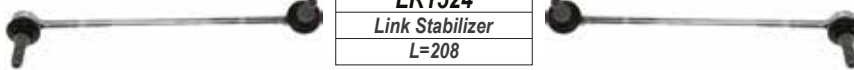

LR1524
Link Stabilizer
L=208



LR1722
Upper Control Arm

LR1723
Upper Control Arm



LR2119
Lower Control Arm Bush

LR2021
Lower Control Arm
Oem Ref: LR034220

LR2022
Lower Control Arm
Oem Ref: LR034219

LR2121
Lower Control Arm Bush

LR2120
Lower Control Arm Bush

LR2121
Lower Control Arm Bush



LR2023
Lower Control Arm
Oem Ref: LR045243

LR2024
Lower Control Arm
Oem Ref: LR045242

DISCOVERY

REAR

LR2923
Bush



LR2618
Lateral Link

LR2923
Bush



LR2618
Lateral Link

LR2923
Bush

LR1525 / LR1526
Link Stabilizer
L=184



LEFT **RIGHT**

LAND ROVER

DISCOVERY SPORT FRONT

L550

Year

2014-

LR1021
Outer Tie Rod End
(Ø16.6*Ø22.9/M18*1.5)

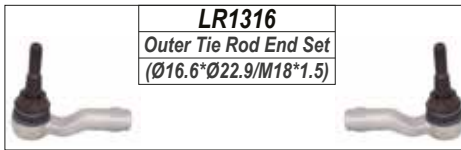

LR1316
Outer Tie Rod End Set
(Ø16.6*Ø22.9/M18*1.5)

LR1413
Rack End
(16*1.5/18*1.5/297)



LR1022
Outer Tie Rod End
(Ø16.6*Ø22.9/M18*1.5)



LR1518
Link Stabilizer
L=320



LR1918
Lower Ball Joint
(Ø10.5)



LR2027
Lower Control Arm

LR2028
Lower Control Arm

LR1918
Lower Ball Joint
(Ø10.5)



DISCOVERY SPORT REAR

LR1519
Link Stabilizer
L=160



LR2619 / LR2620
Lateral Link



LEFT

RIGHT

LAND ROVER

FREELANDER

FRONT

Year

1997-2006

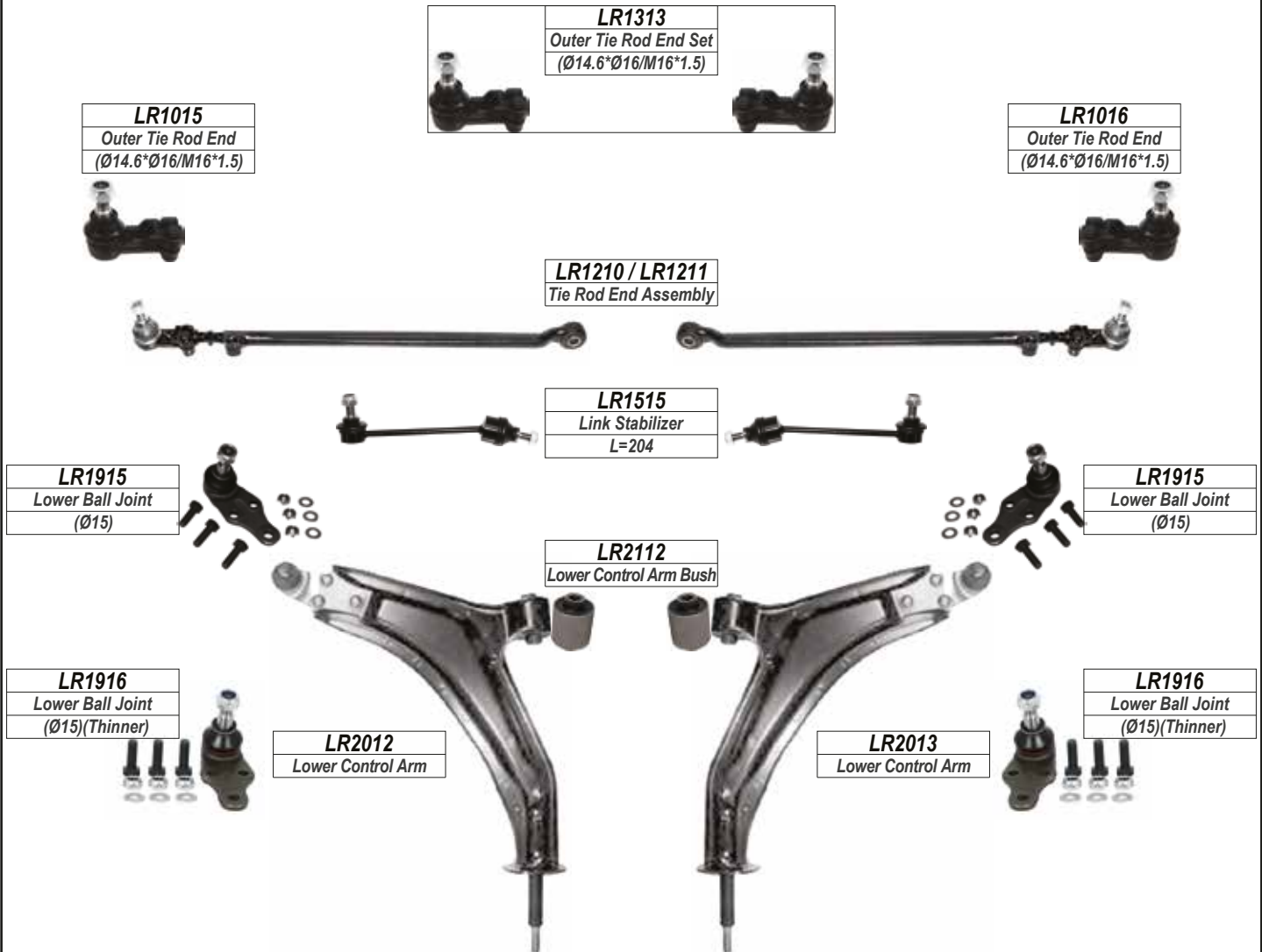

FREELANDER

REAR



LEFT

RIGHT

LAND ROVER

FREELANDER

FRONT

Year

2006-



LR1315
Outer Tie Rod End Set
(Ø16.7*Ø20.1/M18*1.5)

LR1019
Outer Tie Rod End
(Ø16.7*Ø20.1/M18*1.5)



LR1410
Rack End
(16*1.5/18*1.5/314.5)



LR1020
Outer Tie Rod End
(Ø16.7*Ø20.1/M18*1.5)



LR1516
Link Stabilizer
L=348

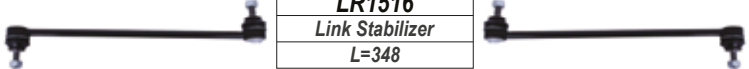

LR2115
Lower Control Arm Bush

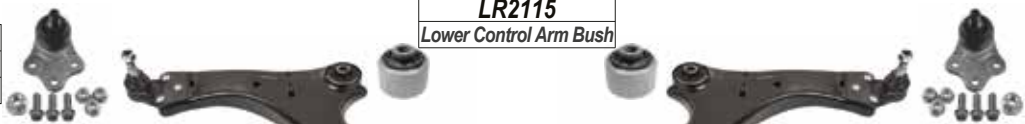

LR1914
Lower Ball Joint
(Ø18)



LR1914
Lower Ball Joint
(Ø18)

LR2014
Lower Control Arm



LR2015
Lower Control Arm



LR2810
Stabilizer Bar Bush



LR2810
Stabilizer Bar Bush



LR2113 / LR2114
Lower Control Arm Bush



FREELANDER

REAR



LR1517
Link Stabilizer
L=229

LR2915
Bush



LR2614
Lateral Link

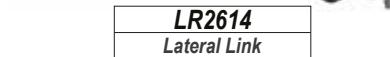

LR2615
Lateral Link



LR2916
Bush



LR2917
Bush



LR2917
Bush

LR2616
Lateral Link

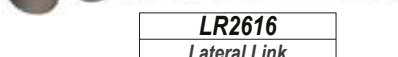

LR2616
Lateral Link

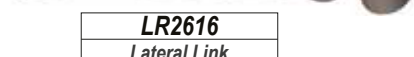

LR2811
Stabilizer Bar Bush



LEFT

RIGHT

LAND ROVER

**RANGE ROVER FRONT
EVOQUE (LV)**

Year

2011-

LR1021
Outer Tie Rod End
(Ø16.6*Ø22.9/M18*1.5)

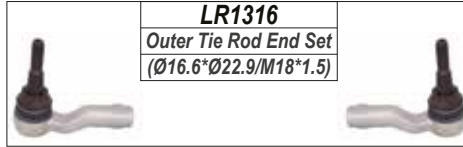

LR1316
Outer Tie Rod End Set
(Ø16.6*Ø22.9/M18*1.5)

LR1413
Rack End
(16*1.5/18*1.5/297)



LR1022
Outer Tie Rod End
(Ø16.6*Ø22.9/M18*1.5)



LR1518
Link Stabilizer
L=320



LR2016
Lower Control Arm

LR2017
Lower Control Arm

LR2116
Lower Control Arm Bush

**RANGE ROVER REAR
EVOQUE (LV)**

LR1517
Link Stabilizer
L=229



LR2811
Stabilizer Bar Bush



LEFT

RIGHT

LAND ROVER

RANGE ROVER
EVOQU

FRONT

II (L551)

Year

2018-

LR1025
Outer Tie Rod End
(Ø16.6*Ø22.9/M16*1.5)



LR1321
Outer Tie Rod End Set
(Ø16.6*Ø22.9/M16*1.5)

LR1417
Rack End
(16*1.5/16*1.5/295)

LR1025
Outer Tie Rod End
(Ø16.6*Ø22.9/M16*1.5)



LR1531
Link Stabilizer
L=302



LR2123
Lower Control Arm Bush



LR2029
Lower Control Arm



LR2030
Lower Control Arm



LR2124 / LR2125
Lower Control Arm Bush



LEFT

RIGHT

LAND ROVER

RANGE ROVER FRONT

Year

1979-1993

LR2216
Center Rod

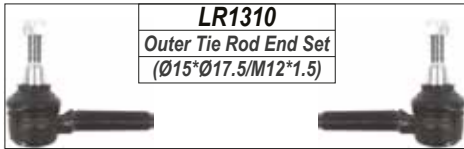

LR1310
Outer Tie Rod End Set
(Ø15*Ø17.5/M12*1.5)

LR1010
Outer Tie Rod End
(Ø15*Ø17.5/M12*1.5)



LR1011
Outer Tie Rod End
(Ø15*Ø17.5/M12*1.5)



LR1510
Link Stabilizer
L=64



LR1910
Lower Ball Joint
(Ø23)



LR1910
Lower Ball Joint
(Ø23)



RANGE ROVER REAR

LR1911
Lower Ball Joint
(Ø20)



LR1911
Lower Ball Joint
(Ø20)



LEFT

RIGHT

LAND ROVER

RANGE ROVER FRONT

Year

1994-2002

||

LR2214

Center Rod



LR2215

Center Rod



LR1311

Outer Tie Rod End Set
(Ø14*Ø17.8/M18*1.5)

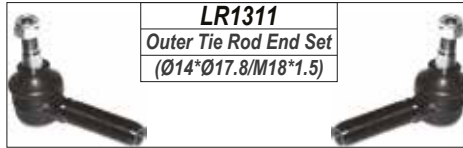

LR1012

Outer Tie Rod End
(Ø14*Ø17.8/M18*1.5)



LR1013

Outer Tie Rod End
(Ø14*Ø17.8/M18*1.5)



LR1519

Link Stabilizer
L=97



LR1912

Lower Ball Joint
(Ø23)



LR1912

Lower Ball Joint
(Ø23)



RANGE ROVER

REAR

LR1911

Lower Ball Joint
(Ø20)



LR1911

Lower Ball Joint
(Ø20)



LEFT

RIGHT

LAND ROVER

RANGE ROVER FRONT

Year

2002-2012

III

LR1317
Outer Tie Rod End Set
(Ø15.4*Ø18.3/M16*1.5)

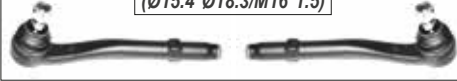

LR1017
Outer Tie Rod End
(Ø15.4*Ø18.3/M16*1.5)



BM1427
Rack End
(18*1.5/16*1.5/230)



LR1017
Outer Tie Rod End
(Ø15.4*Ø18.3/M16*1.5)



LR1520
Link Stabilizer
L=380



LR1811
Upper Control Arm Bush



LR1611
Upper Ball Joint
(Ø13.7)



LR1611
Upper Ball Joint
(Ø13.7)



LR1714
Upper Control Arm



LR1715
Upper Control Arm



LR2117
Lower Control Arm Bush



LR1917
Lower Ball Joint
(Ø18.45)



LR1917
Lower Ball Joint
(Ø18.45)



LR2018
Lower Control Arm



LR2018
Lower Control Arm



RANGE ROVER REAR

REAR

LR1521
Link Stabilizer
L=120



LR2918
Bush



LR2617
Lateral Link
L=301.5

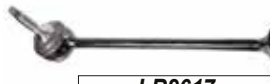

LR2617
Lateral Link
L=301.5

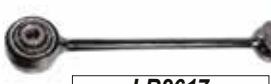

LR2919
Bush



LR2920
Bush



LR2921
Bush



LEFT

RIGHT

LAND ROVER

RANGE ROVER

FRONT

IV (L405)

Year

2012-

LR1023
Outer Tie Rod End
(Ø16.55*Ø22.9/M14*1.5)

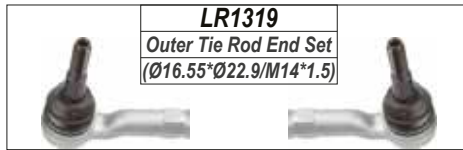

LR1319
Outer Tie Rod End Set
(Ø16.55*Ø22.9/M14*1.5)

LR1415
Rack End
(16*1.5/14*1.5/329)



LR1023
Outer Tie Rod End
(Ø16.55*Ø22.9/M14*1.5)



LR1024
Outer Tie Rod End
(Ø16.55*Ø22.9/M16*1.5)

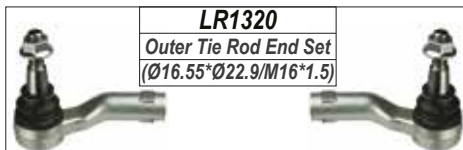

LR1320
Outer Tie Rod End Set
(Ø16.55*Ø22.9/M16*1.5)

LR1416
Rack End
(20*1.5/16*1.5/369)



LR1024
Outer Tie Rod End
(Ø16.55*Ø22.9/M16*1.5)



LR1716
Upper Control Arm
Oem Ref: LR034214

LR1812
Upper Control Arm Bush



LR1717
Upper Control Arm
Oem Ref: LR034211



LR1720
Upper Control Arm
Oem Ref: LR034215

LR1812
Upper Control Arm Bush



LR1721
Upper Control Arm
Oem Ref: LR034212

LEFT

RIGHT

LAND ROVER

RANGE ROVER FRONT

IV (L405)

Year

2012-

LR2121
Lower Control Arm Bush

LR2120
Lower Control Arm Bush

LR2121
Lower Control Arm Bush



LR2023
Lower Control Arm
Oem Ref: LR045243

LR2024
Lower Control Arm
Oem Ref: LR045242

LR2119
Lower Control Arm Bush



LR2021
Lower Control Arm
Oem Ref: LR034220

LR2022
Lower Control Arm
Oem Ref: LR034219

RANGE ROVER

REAR

LR1525 / LR1526
Link Stabilizer
L=184



LR2923
Bush

LR2923
Bush

LR2923
Bush

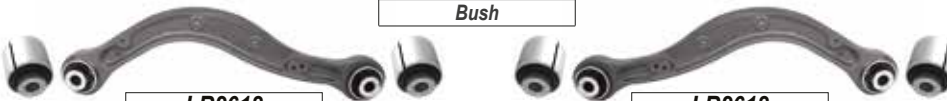

LR2618
Lateral Link

LR2618
Lateral Link

LEFT

RIGHT

LAND ROVER

RANGE ROVER FRONT

SPORT

Year

2005-2013

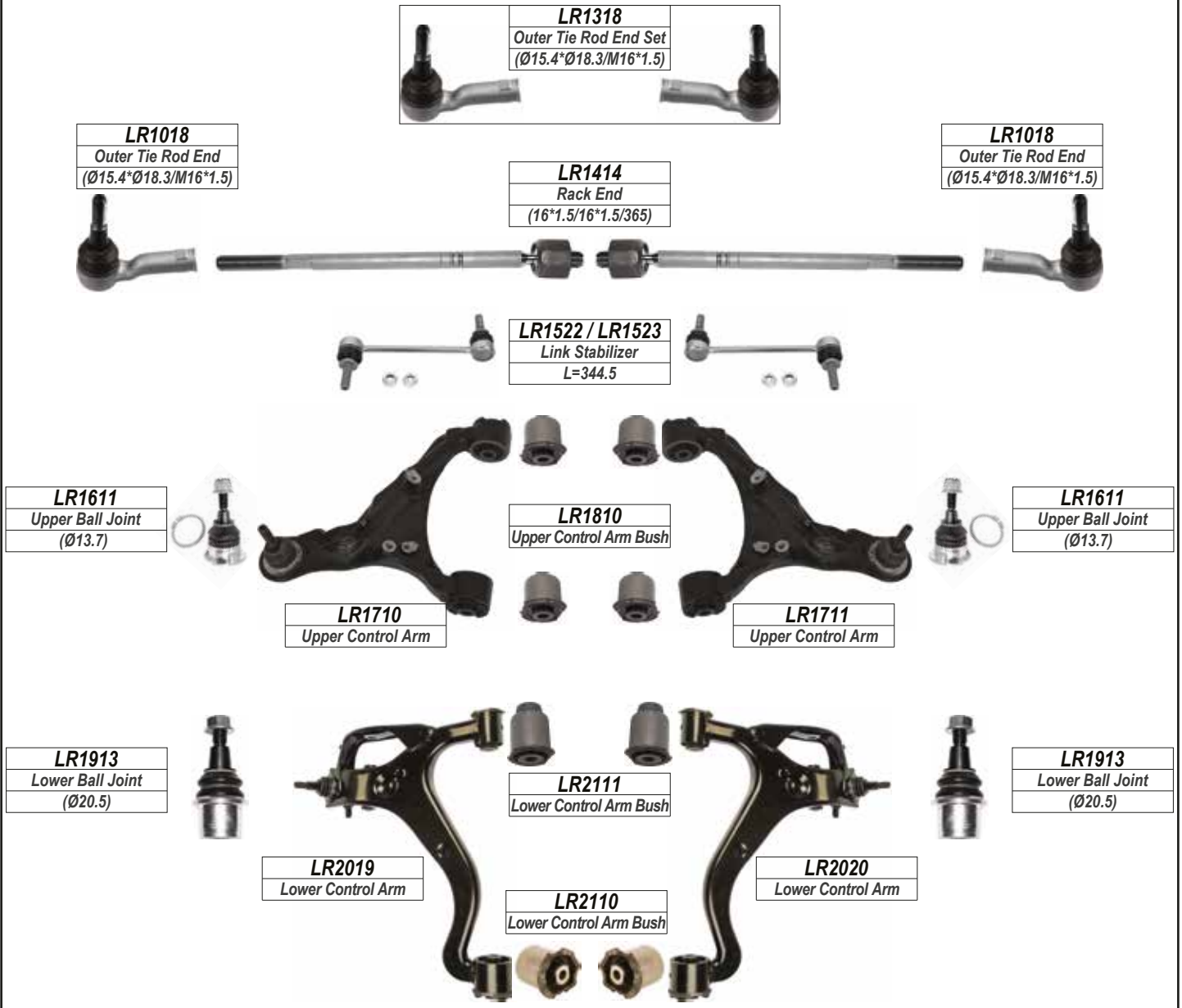

RANGE ROVER REAR



LEFT

RIGHT

LAND ROVER

RANGE ROVER

FRONT

SPORT. VOGUE

Year

2013-

LR1023
Outer Tie Rod End
(Ø16.55*Ø22.9/M14*1.5)

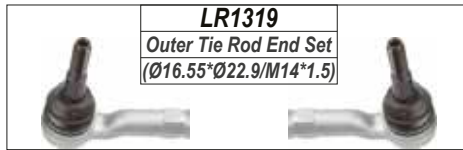

LR1319
Outer Tie Rod End Set
(Ø16.55*Ø22.9/M14*1.5)

LR1415
Rack End
(16*1.5/14*1.5/329)



LR1023
Outer Tie Rod End
(Ø16.55*Ø22.9/M14*1.5)

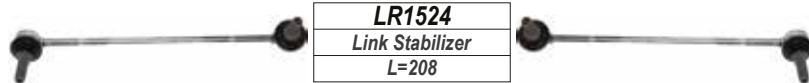

LR1524
Link Stabilizer
L=208



LR1716
Upper Control Arm
Oem Ref: LR034214

LR1812
Upper Control Arm Bush



LR1717
Upper Control Arm
Oem Ref: LR034211



LR1718
Upper Control Arm
Oem Ref: LR034216

LR1812
Upper Control Arm Bush



LR1719
Upper Control Arm
Oem Ref: LR034213



LR1720
Upper Control Arm
Oem Ref: LR034215

LR1812
Upper Control Arm Bush



LR1721
Upper Control Arm
Oem Ref: LR034212

LEFT

RIGHT

LAND ROVER

RANGE ROVER FRONT

SPORT. VOGUE

Year

2013-

LR2119
Lower Control Arm Bush



LR2021
Lower Control Arm
Oem Ref: LR034220

LR2022
Lower Control Arm
Oem Ref: LR034219

LR2121
Lower Control Arm Bush

LR2120
Lower Control Arm Bush

LR2121
Lower Control Arm Bush



LR2023
Lower Control Arm
Oem Ref: LR045243

LR2024
Lower Control Arm
Oem Ref: LR045242

LR2122
Lower Control Arm Bush

LR2120
Lower Control Arm Bush

LR2122
Lower Control Arm Bush



LR2025
Lower Control Arm
Oem Ref: LR034218

LR2026
Lower Control Arm
Oem Ref: LR034217

LR2812
Stabilizer Bar Bush



RANGE ROVER REAR

LR1525 / LR1526
Link Stabilizer
L=184



LR1527 LR1528
Link Stabilizer
L=190.5



LR2923
Bush

LR2923
Bush

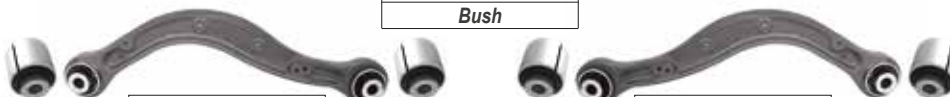

LR2923
Bush

LR2618
Lateral Link

LR2618
Lateral Link

LR2924
Bush



LEFT

RIGHT

LAND ROVER

RANGE ROVER

FRONT

VELAR (L560)

Year

2017-

LR1026
Outer Tie Rod End
(Ø14*Ø20/M14*1.5)



LR1322
Outer Tie Rod End Set
(Ø14*Ø20/M14*1.5)

LR1418
Rack End
(16*1.5/14*1.5/226)



LR1026
Outer Tie Rod End
(Ø14*Ø20/M14*1.5)



LR1532
Link Stabilizer
L=220



LR1823
Upper Control Arm Bush



LR1724
Upper Control Arm



LR1725
Upper Control Arm



LR2031
Lower Control Arm



LR2031
Lower Control Arm



LR2032
Lower Control Arm



LR2033
Lower Control Arm



RANGE ROVER

REAR



LR2621
Lateral Arm



LR1533
Link Stabilizer
L=185.5

LEFT

RIGHT

MAHINDRA

BOLERO

FRONT

ALL MODELS

Year

2003-

MH1010
Outer Tie Rod End
(Ø14.2*Ø16/M18*1.5)(M/S)

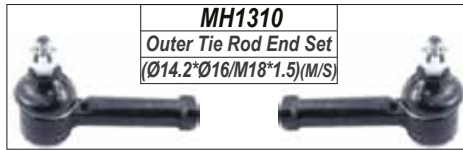

MH1310
Outer Tie Rod End Set
(Ø14.2*Ø16/M18*1.5)(M/S)

MH1010
Outer Tie Rod End
(Ø14.2*Ø16/M18*1.5)(M/S)



MH1311
Outer Tie Rod End Set
(Ø14*Ø16.5/M14*1.5)(P/S)

MH1011
Outer Tie Rod End
(Ø14*Ø16.5/M14*1.5)(P/S)



MH1413
Rack End
(14*1.5/14*1.5/291)

MH1011
Outer Tie Rod End
(Ø14*Ø16.5/M14*1.5)(P/S)



MH1510 / MH1511
Link Stabilizer
L=156



MH1614
Upper Ball Joint
(Ø16.4)



MH1614
Upper Ball Joint
(Ø16.4)



MH1910
Lower Ball Joint
(---)



MH1910
Lower Ball Joint
(---)



LEFT

RIGHT

MAHINDRA

SCORPIO

FRONT

ALL MODELS

Year

2003-

MH1012
Outer Tie Rod End
(Ø13.5*Ø14/M12*1.25)

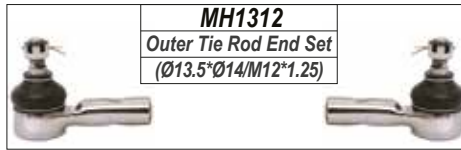

MH1312
Outer Tie Rod End Set
(Ø13.5*Ø14/M12*1.25)

MH1410
Rack End
(14*1.5/14*1.5/294)



MH1012
Outer Tie Rod End
(Ø13.5*Ø14/M12*1.25)



MH1510 / MH1511
Link Stabilizer
L=156



MH1514
Link Stabilizer
L=171



MH1615
Upper Ball Joint
(Ø17.7)



MH1615
Upper Ball Joint
(Ø17.7)



MH1911
Lower Ball Joint
(Ø17.6)



MH1911
Lower Ball Joint
(Ø17.6)



LEFT

RIGHT

MAHINDRA

XUV500

FRONT

ALL MODELS

Year

2011-

MH1014
Outer Tie Rod End
(Ø15*Ø15/M14*1.50)



MH1015
Outer Tie Rod End
(Ø15*Ø15/M14*1.50)



MH1412
Rack End
(14*1.5/14*1.5/178)



MH1515 / MH1516
Link Stabilizer
L=285



MH1913
Lower Ball Joint
(Ø22)



MH1913
Lower Ball Joint
(Ø22)



LEFT

RIGHT

MAHINDRA

XYLO

FRONT

ALL MODELS

Year

2010-

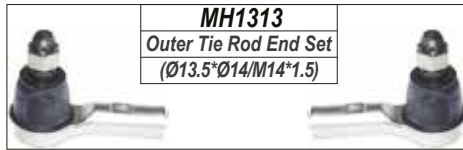

MH1313
Outer Tie Rod End Set
(Ø13.5*Ø14/M14*1.5)

MH1013
Outer Tie Rod End
(Ø13.5*Ø14/M14*1.5)



MH1411
Rack End
(16*1.5/14*1.5/275)

MH1013
Outer Tie Rod End
(Ø13.5*Ø14/M14*1.5)



MH1512 / MH1513
Link Stabilizer
L=118



MH1710
Upper Control Arm

MH1710
Upper Control Arm

MH1912
Lower Ball Joint
(Ø17.6)



MH1912
Lower Ball Joint
(Ø17.6)



LEFT

RIGHT

MAZDA

121

FRONT

ALL MODELS

Year

1997-2004

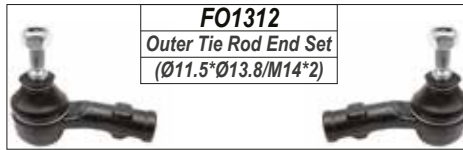

FO1312
Outer Tie Rod End Set
(Ø11.5*Ø13.8/M14*2)

FO1027
Outer Tie Rod End
(Ø11.5*Ø13.8/M14*2)



FO1423
Rack End
(14*1.5/14*2.0/306)



FO1028
Outer Tie Rod End
(Ø11.5*Ø13.8/M14*2)



FO1438
Rack End
(14*1.5/14*2/287)



FO1510
Link Stabilizer
L=239



FO2113
Lower Control Arm Bush

FO1913
Lower Ball Joint
(Ø16.5)



FO2028
Lower Control Arm

FO2029
Lower Control Arm

FO1913
Lower Ball Joint
(Ø16.5)



FO2818
Shock Mounting



FO2114
Lower Control Arm Bush



FO2818
Shock Mounting



121

REAR

MA1510
Link Stabilizer
L=80



LEFT

RIGHT

MAZDA

2

FRONT

ALL MODELS

Year

2007-2009

FO1035
Outer Tie Rod End
(Ø11.55*Ø13.8/M14*1.5)

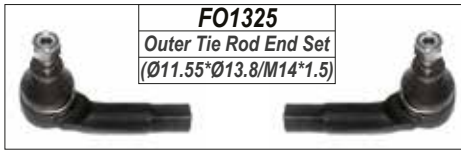

FO1325
Outer Tie Rod End Set
(Ø11.55*Ø13.8/M14*1.5)

FO1435
Rack End
(14*1.5/14*1.5/277)

FO1036
Outer Tie Rod End
(Ø11.55*Ø13.8/M14*1.5)



FO1037
Outer Tie Rod End
(Ø12.8*Ø15.6/M14*1.5)



FO1326
Outer Tie Rod End Set
(Ø12.8*Ø15.6/M14*1.5)

FO1427
Rack End
(14*1.5/14*1.5/213)

FO1038
Outer Tie Rod End
(Ø12.8*Ø15.6/M14*1.5)

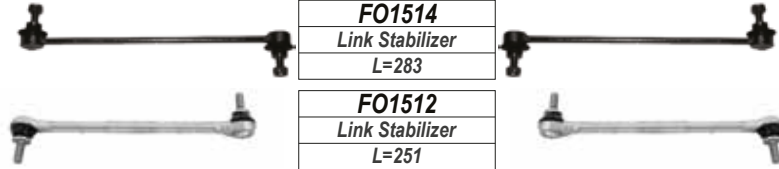

FO1514
Link Stabilizer
L=283

FO1512
Link Stabilizer
L=251

FO1918
Lower Ball Joint
(Ø16.5)



FO2032
Lower Control Arm

FO2033
Lower Control Arm

FO1918
Lower Ball Joint
(Ø16.5)



FO2119
Lower Control Arm Bush

FO2819
Shock Mounting



FO2819
Shock Mounting



FO2120
Lower Control Arm Bush

2

REAR

FO2820
Shock Mounting



FO2820
Shock Mounting



LEFT

RIGHT

MAZDA

2

FRONT

ALL MODELS

Year

2009-2015

FO1010
Outer Tie Rod End
(Ø12.9*Ø15.65/M14*1.5)

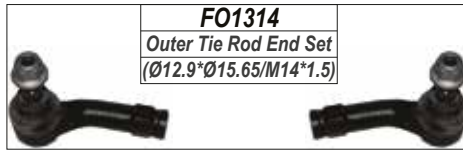

FO1314
Outer Tie Rod End Set
(Ø12.9*Ø15.65/M14*1.5)

FO1411
Rack End
(14*1.5/14*1.5/295)

FO1011
Outer Tie Rod End
(Ø12.9*Ø15.65/M14*1.5)



FO1326
Outer Tie Rod End Set
(Ø12.8*Ø15.6/M14*1.5)

FO1037
Outer Tie Rod End
(Ø12.8*Ø15.6/M14*1.5)



FO1427
Rack End
(14*1.5/14*1.5/213)



FO1038
Outer Tie Rod End
(Ø12.8*Ø15.6/M14*1.5)

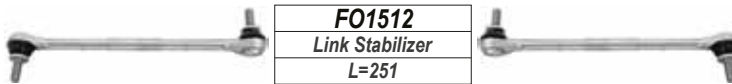

FO1512
Link Stabilizer
L=251

FO2121
Lower Control Arm Bush



FO1910
Lower Ball Joint
(Ø17.5)



FO2034
Lower Control Arm

FO2035
Lower Control Arm

FO1910
Lower Ball Joint
(Ø17.5)



FO2819
Shock Mounting



FO2122
Lower Control Arm Bush



FO2819
Shock Mounting



2

REAR

FO2820
Shock Mounting



FO2820
Shock Mounting



LEFT

RIGHT

MAZDA

2

FRONT

ALL MODELS

Year

2014-

MA1029
Outer Tie Rod End
(Ø12.65*Ø15.5/M14*1.5)



MA1323
Outer Tie Rod End Set
(Ø12.65*Ø15.5/M14*1.5)

MA1424
Rack End
(14*1.5/16*1.5/244)



MA1030
Outer Tie Rod End
(Ø12.65*Ø15.5/M14*1.5)



MA1530
Link Stabilizer
L=251



MA2130
Lower Control Arm Bush



FO1910
Lower Ball Joint
(Ø17.5)



FO1910
Lower Ball Joint
(Ø17.5)



MA2037
Lower Control Arm



MA2038
Lower Control Arm



MA2131
Lower Control Arm Bush



FO2819
Shock Mounting



FO2819
Shock Mounting



LEFT

RIGHT

MAZDA

3

FRONT

ALL MODELS

Year

2004-2009V

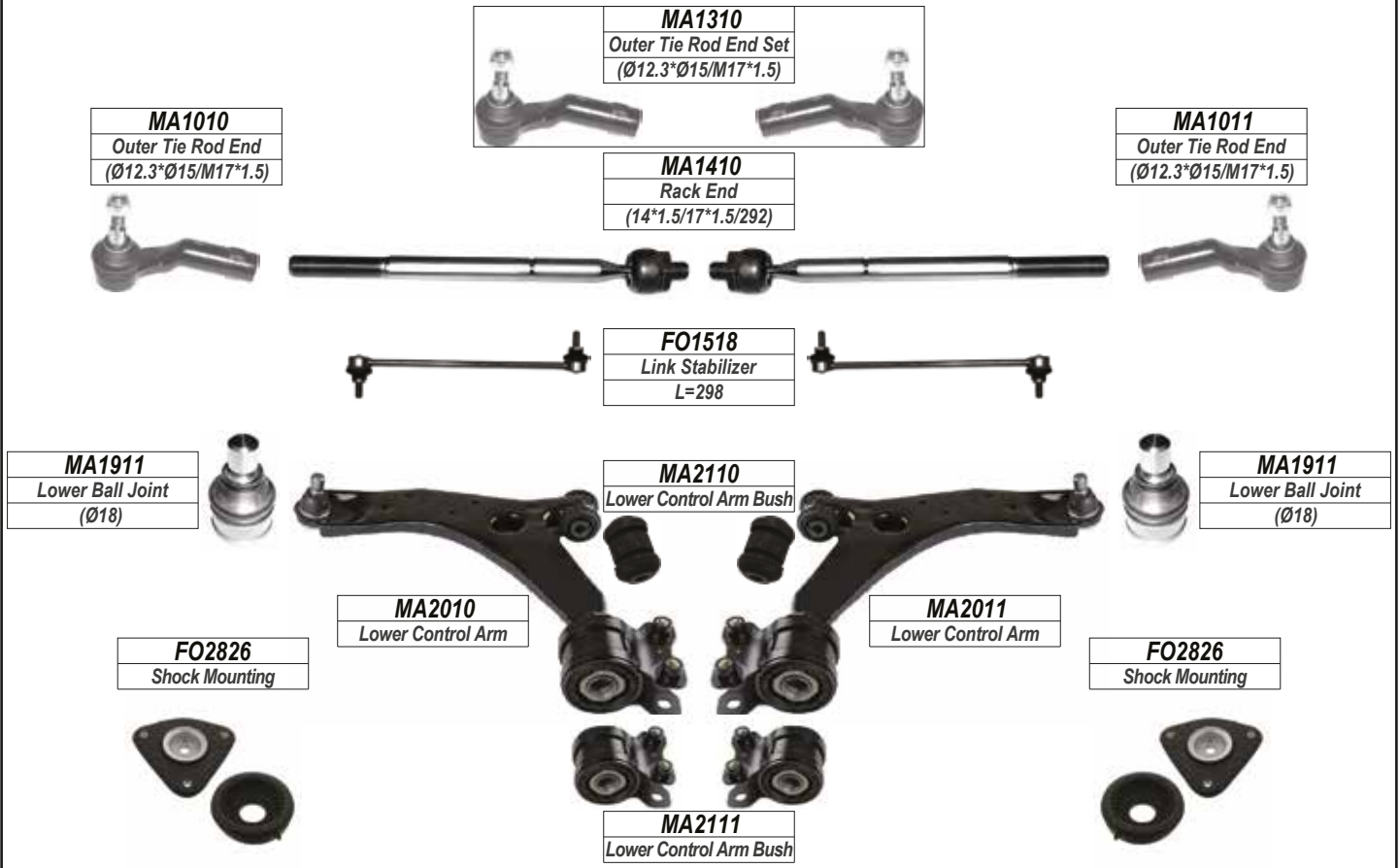

3

REAR



LEFT

RIGHT

MAZDA

3

FRONT

ALL MODELS

Year

2009-2014

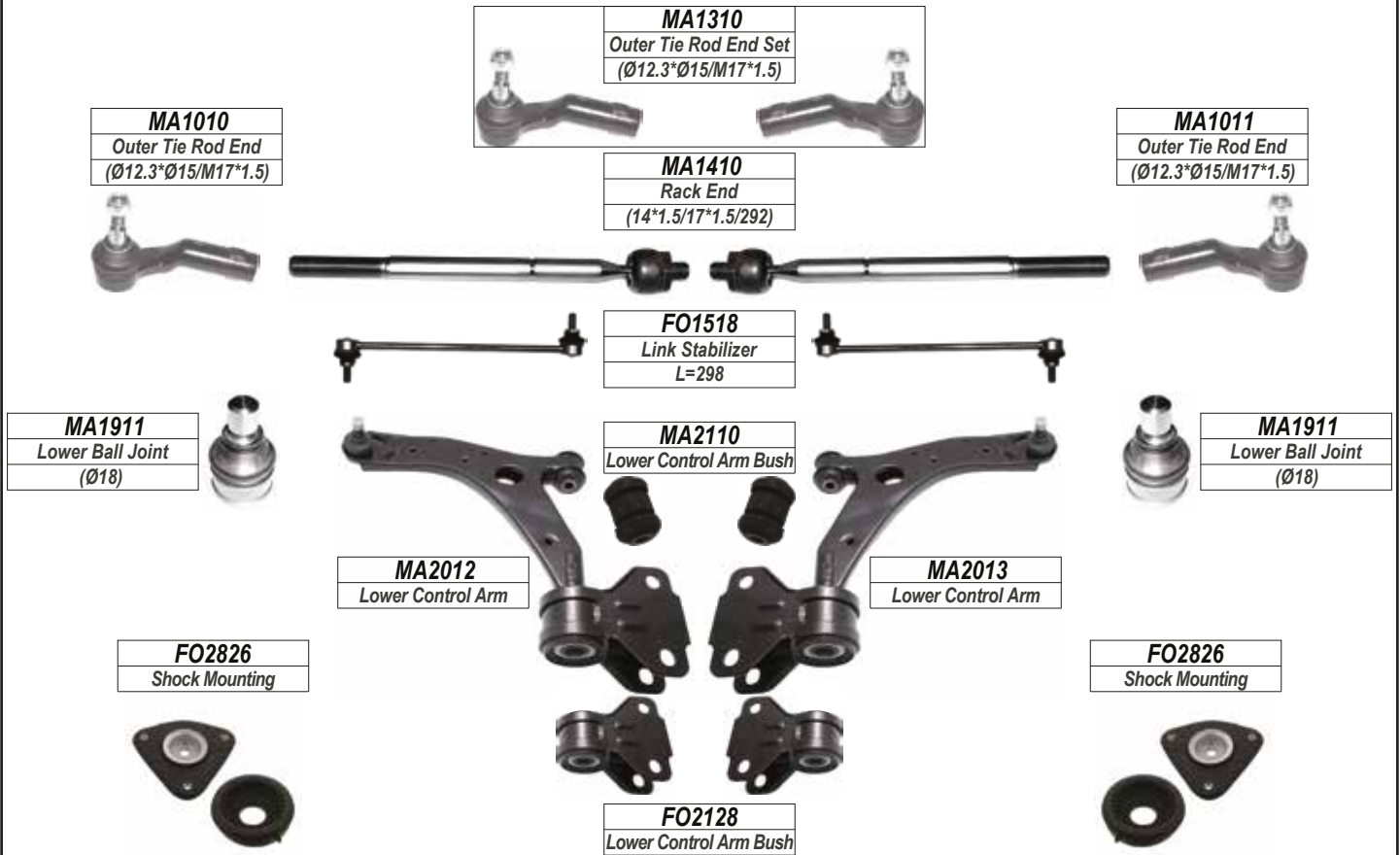

3

REAR

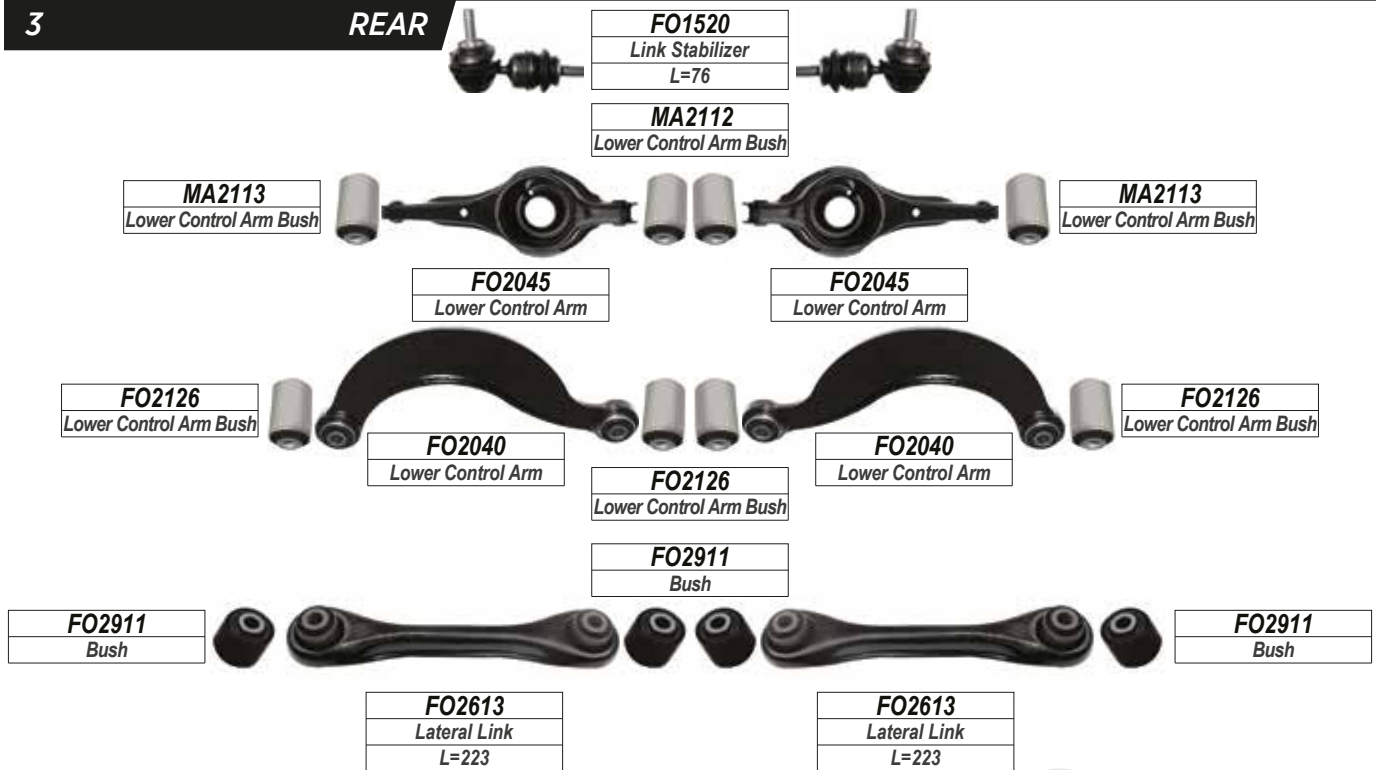

LEFT

RIGHT

MAZDA

323

FRONT

ALL MODELS

Year

1981-1986

MA1014
Outer Tie Rod End
(Ø12.7*Ø14.2/M12*1.25)



FO1410
Rack End
(14*1.5/12*1.25/305)



MA1015
Outer Tie Rod End
(Ø12.7*Ø14.2/M12*1.25)



FO1912
Lower Ball Joint
(Ø16)



FO1912
Lower Ball Joint
(Ø16)

LEFT

RIGHT

MAZDA

323

FRONT

MIDGE.SEDAN.STING

Year

1986-2004

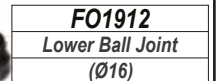
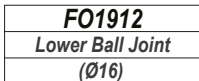
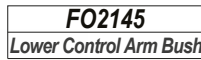
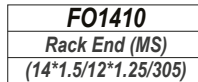
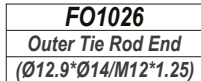
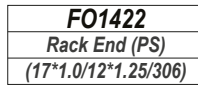
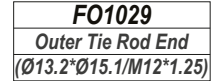
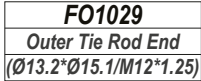
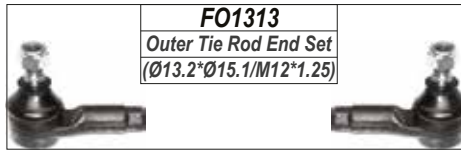

LEFT

RIGHT

MAZDA

5

FRONT

ALL MODELS

Year

2007-

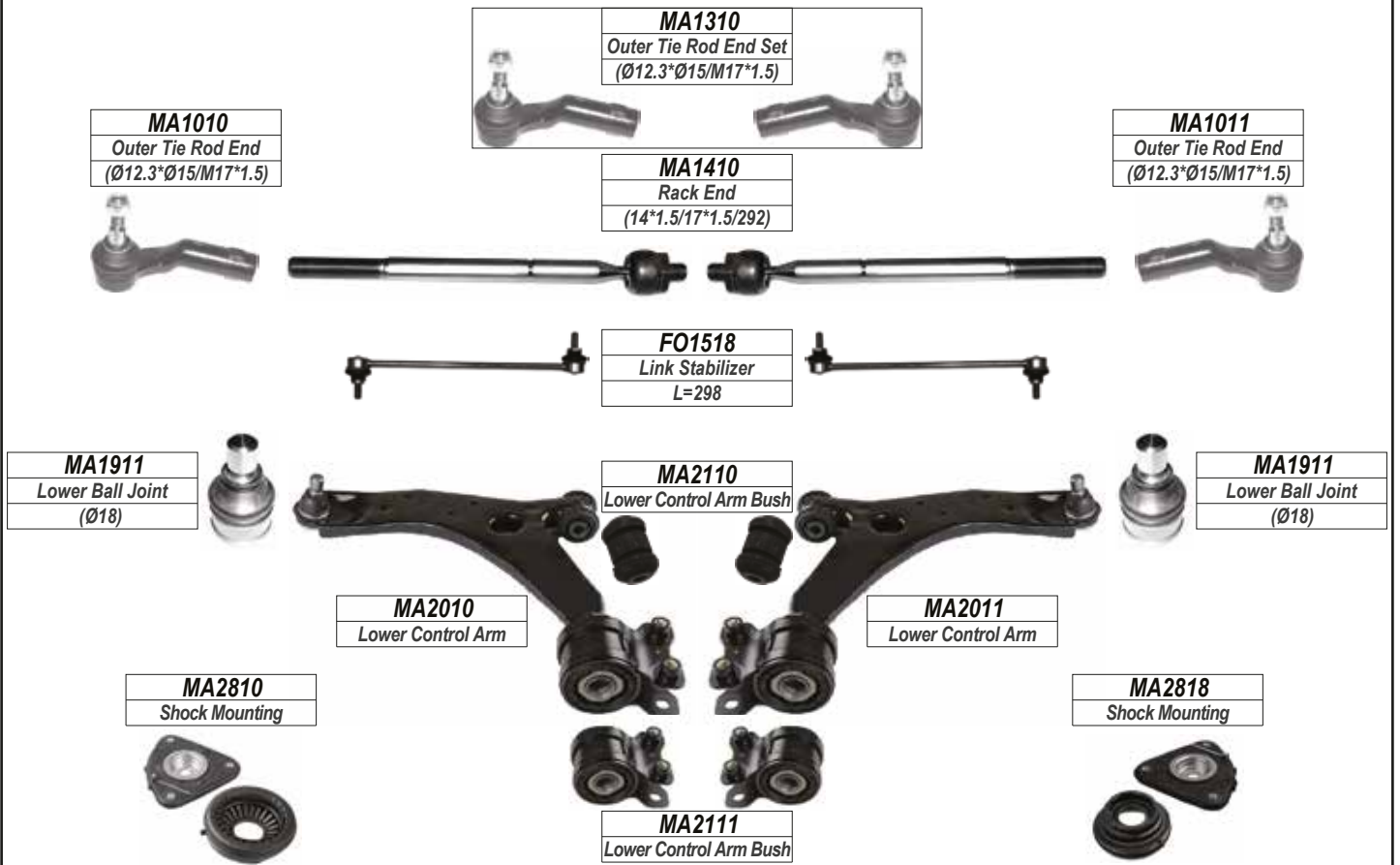

3

REAR

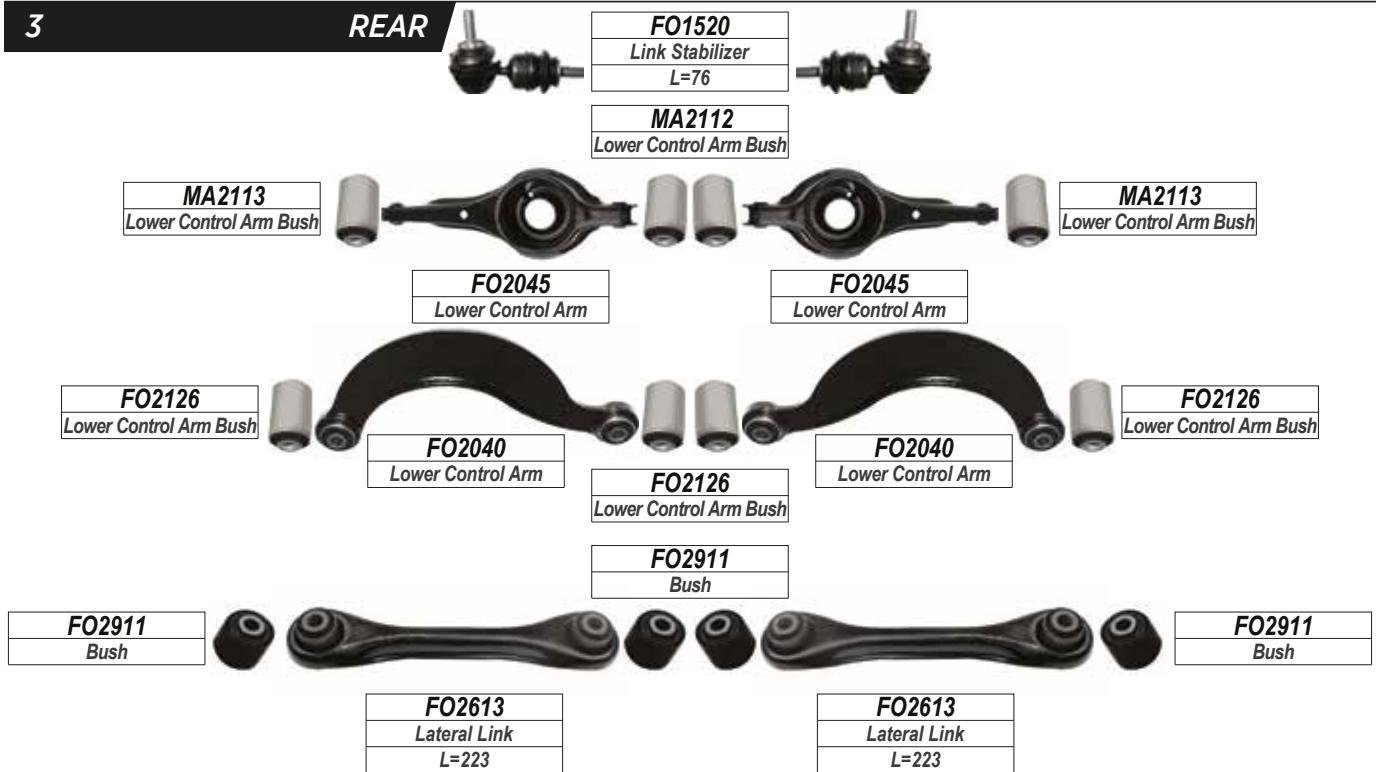

LEFT

RIGHT

MAZDA

6

FRONT

ALL MODELS

Year

2003-2007

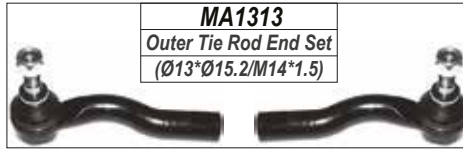

MA1313
Outer Tie Rod End Set
(Ø13*Ø15.2/M14*1.5)

MA1016
Outer Tie Rod End
(Ø13*Ø15.2/M14*1.5)



MA1412
Rack End
(18*1.5/14*1.5/182)



MA1017
Outer Tie Rod End
(Ø13*Ø15.2/M14*1.5)

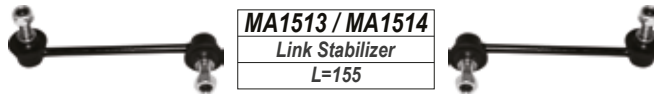

MA1513 / MA1514
Link Stabilizer
L=155

MA1611
Upper Ball Joint
(Ø12.6)



MA1710
Upper Control Arm

MA1810
Upper Control Arm Bush



MA1711
Upper Control Arm

MA1611
Upper Ball Joint
(Ø12.6)



MA2119
Lower Control Arm Bush



MA2017
Lower Control Arm



MA2018
Lower Control Arm

MA2118
Lower Control Arm Bush



MA2118
Lower Control Arm Bush



MA2016
Lower Control Arm

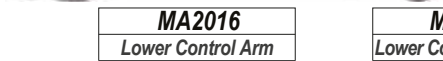

MA2117
Lower Control Arm Bush



MA2016
Lower Control Arm

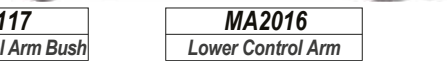

6

REAR

MA1515
Link Stabilizer
L=77



LEFT

RIGHT

MAZDA

6

FRONT

ALL MODELS

Year

2008-2013

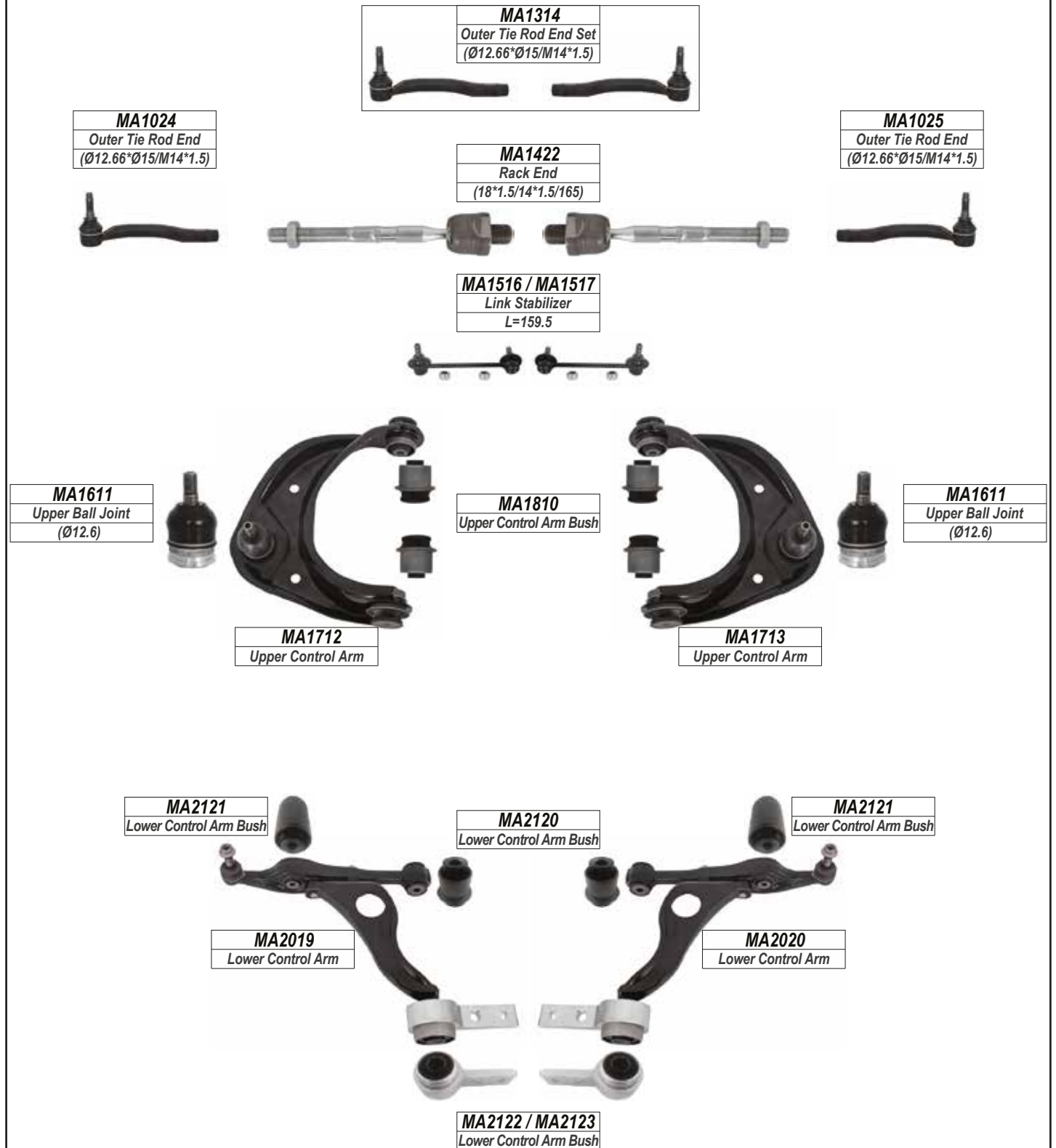

LEFT

RIGHT

MAZDA

6

FRONT

ALL MODELS

Year

2014-

MA1026
Outer Tie Rod End
(Ø12.65*Ø15.5/M14*1.5)

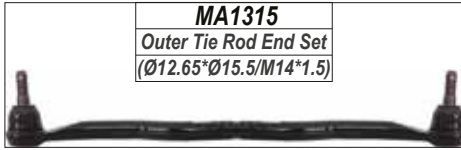

MA1315
Outer Tie Rod End Set
(Ø12.65*Ø15.5/M14*1.5)

MA1413
Rack End
(20*1.5/14*1.5/178)



MA1027
Outer Tie Rod End
(Ø12.65*Ø15.5/M14*1.5)



MA1513 / MA1514
Link Stabilizer
L=155



MA2114
Lower Control Arm Bush

MA1910
Lower Ball Joint
(Ø20)



MA2025
Lower Control Arm

MA2026
Lower Control Arm

MA1910
Lower Ball Joint
(Ø20)

MA2124 / MA2125
Lower Control Arm Bush

6

REAR

MA1518
Link Stabilizer
L=95



LEFT

RIGHT

MAZDA

626

FRONT

ALL MODELS

Year

1983-1993

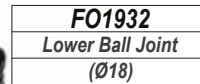
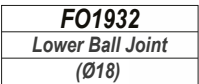
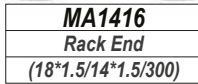
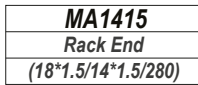
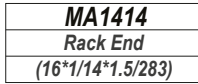
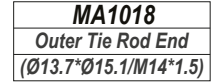
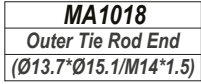
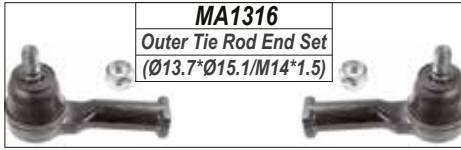

LEFT

RIGHT

MAZDA

626

FRONT

ALL MODELS

Year

1993-2003

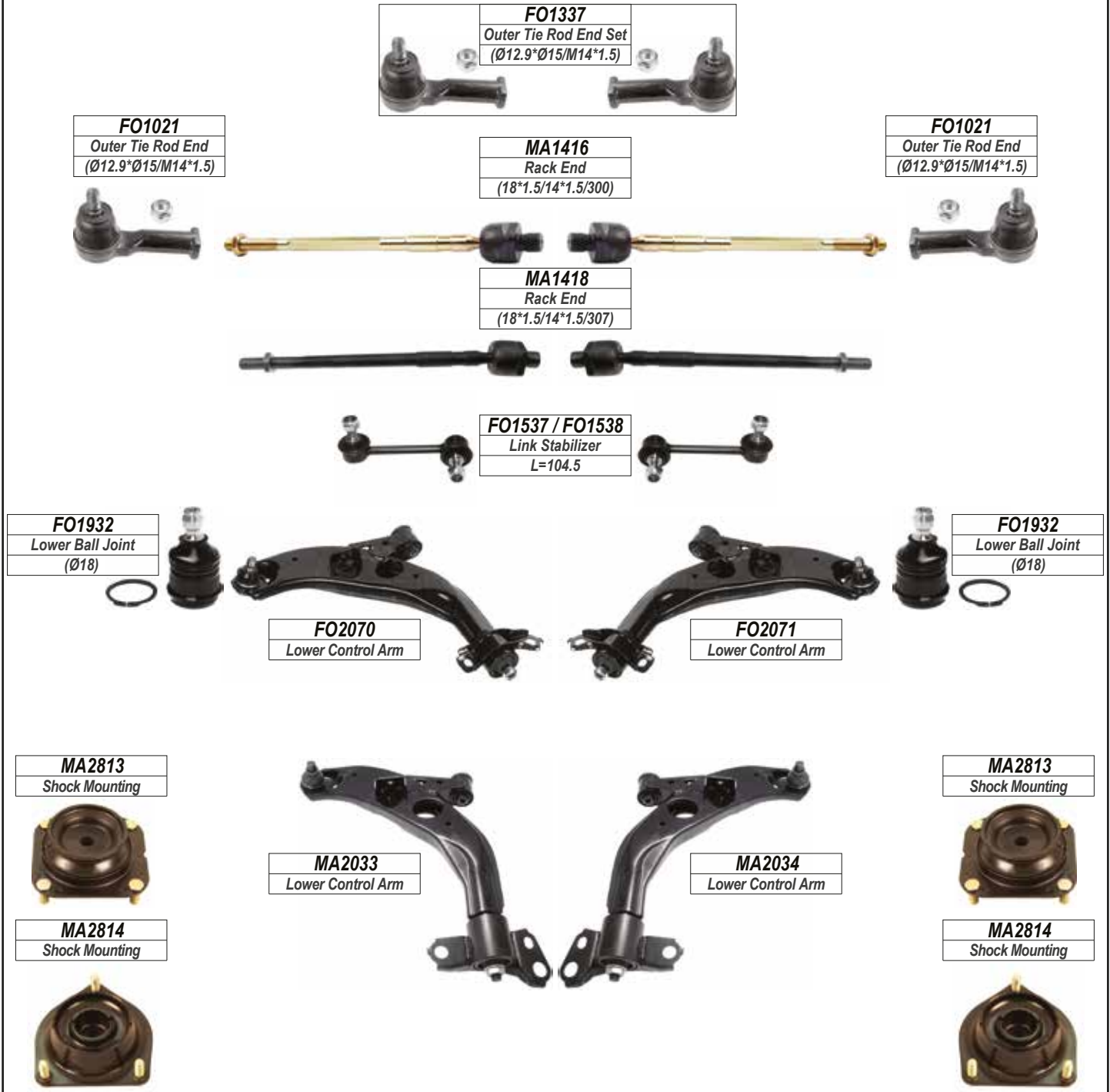

626

REAR

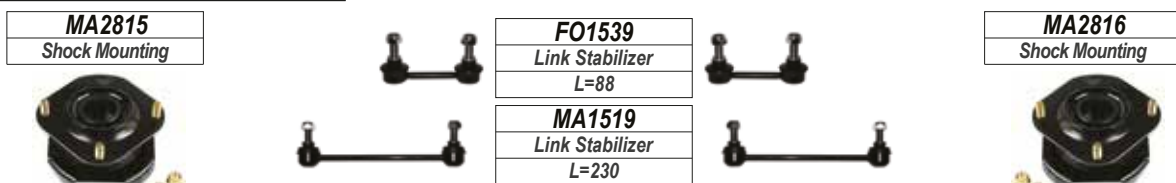

LEFT

RIGHT

MAZDA

ASTINA

FRONT

ALL MODELS

Year

1995-2000

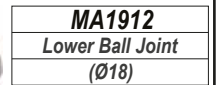
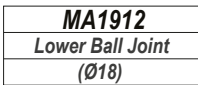
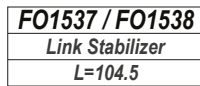
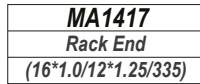
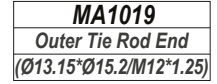
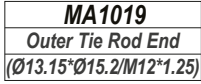
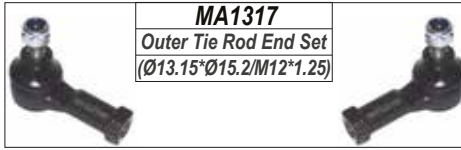

LEFT

RIGHT

MAZDA

B SERIES

FRONT

ALL MODELSS

Year

1982-1986

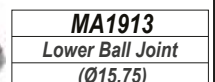
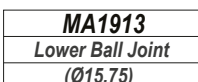
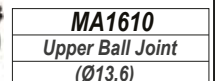
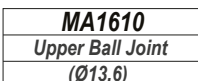
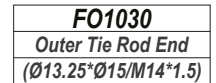
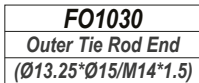
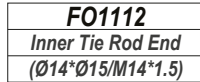
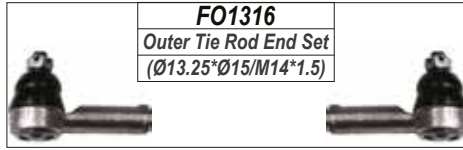

LEFT

RIGHT

MAZDA

B SERIES

FRONT

2WD

Year

1986-2000

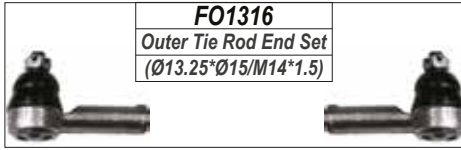

FO1112
Inner Tie Rod End
(Ø14*Ø15/M14*1.5)



FO1030
Outer Tie Rod End
(Ø13.25*Ø15/M14*1.5)



FO1111
Inner Tie Rod End
(Ø15*Ø17/M14*1.5)



FO1030
Outer Tie Rod End
(Ø13.25*Ø15/M14*1.5)



FO1611
Upper Ball Joint
(Ø13.6)



FO1710
Upper Control Arm

FO1810
Upper Control Arm Bush



FO1711
Upper Control Arm

FO1611
Upper Ball Joint
(Ø13.6)



FO1914
Lower Ball Joint
STD Body(Ø17.8)



FO2020
Lower Control Arm

CA2110
Lower Control Arm Bush



FO2021
Lower Control Arm

FO1914
Lower Ball Joint
STD Body(Ø17.8)



FO2410
Idler Arm



FO2512
Pitman Arm
Spline : 27mm



FO2513
Pitman Arm
Spline : 25mm



LEFT

RIGHT

MAZDA

B SERIES

FRONT

4WD

Year

1986-2000

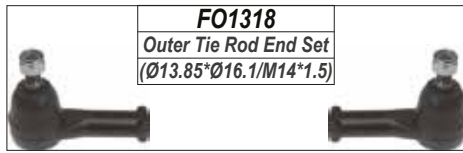

FO1318
Outer Tie Rod End Set
(Ø13.85*Ø16.1/M14*1.5)



MA1318
Inner Tie Rod End Set
(Ø13.54*Ø15.6/M14*1.5)

FO1031
Outer Tie Rod End
(Ø13.85*Ø16.1/M14*1.5)



MA1110
Inner Tie Rod End
(Ø13.54*Ø15.6/M14*1.5)



FO1031
Outer Tie Rod End
(Ø13.85*Ø16.1/M14*1.5)



FO1810
Upper Control Arm Bush



FO1611
Upper Ball Joint
(Ø13.6)



FO1611
Upper Ball Joint
(Ø13.6)



FO1712
Upper Control Arm



FO1713
Upper Control Arm

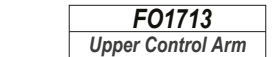

FO2115
Lower Control Arm Bush



FO1915
Lower Ball Joint
(Ø17.75)



FO1915
Lower Ball Joint
(Ø17.75)



FO2022
Lower Control Arm



CA2110
Lower Control Arm Bush



FO2023
Lower Control Arm

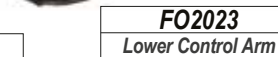

FO2410
Idle Arm



FO2512
Pitman Arm
Spline : 27mm

LEFT

RIGHT

MAZDA

B SERIES

FRONT

ALL MODELS

Year

2000-2007

FO1030
Outer Tie Rod End
(Ø13.25*Ø15/M14*1.5)

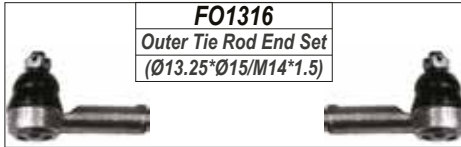

FO1316
Outer Tie Rod End Set
(Ø13.25*Ø15/M14*1.5)



FO1315
Inner Tie Rod End Set
(Ø15*Ø17/M14*1.5)

FO1111
Inner Tie Rod End
(Ø15*Ø17/M14*1.5)



FO1030
Outer Tie Rod End
(Ø13.25*Ø15/M14*1.5)

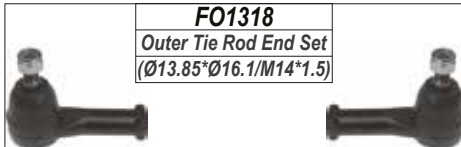

FO1318
Outer Tie Rod End Set
(Ø13.85*Ø16.1/M14*1.5)



MA1318
Inner Tie Rod End Set
(Ø13.54*Ø15.6/M14*1.5)

MA1110
Inner Tie Rod End
(Ø13.54*Ø15.6/M14*1.5)



FO1031
Outer Tie Rod End
(Ø13.85*Ø16.1/M14*1.5)



FO1031
Outer Tie Rod End
(Ø13.85*Ø16.1/M14*1.5)



FO2710
Repair Kit



FO1712
Upper Control Arm
Hi-Ride



FO1713
Upper Control Arm
Hi-Ride



FO1722
Upper Control Arm



FO1723
Upper Control Arm

FO1611
Upper Ball Joint
(Ø13.6)



FO1611
Upper Ball Joint
(Ø13.6)



LEFT

RIGHT

MAZDA

B SERIES

FRONT

ALL MODELS

Year

2000-2007



FO1811
Upper Control Arm Bush

FO1714
Upper Control Arm

FO1715
Upper Control Arm



FO1914
Lower Ball Joint
(Ø17.8)

FO2020
Lower Control Arm

CA2110
Lower Control Arm Bush

FO2021
Lower Control Arm

FO1914
Lower Ball Joint
(Ø17.8)



FO2115
Lower Control Arm Bush

FO1915
Lower Ball Joint
Hi Ride(Ø17.75)

FO2022
Lower Control Arm
Hi Ride

CA2110
Lower Control Arm Bush

FO2023
Lower Control Arm
Hi Ride

FO1915
Lower Ball Joint
Hi Ride(Ø17.75)

FO2411
Idler Arm



FO2512
Pitman Arm
Spline : 27mm / (Ø10)



FO2511
Pitman Arm
(Ø14.3)



FO2514
Pitman Arm
(Ø15.3)



LEFT

RIGHT

MAZDA

BT-50

FRONT

ALL MODELS

Year

2006-2012

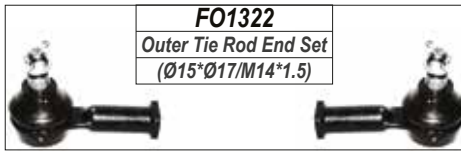

FO1014
Outer Tie Rod End
(Ø15*Ø17/M14*1.5)



FO1110
Inner Tie Rod End
(Ø14.9*Ø17/M14*1.5)



FO1014
Outer Tie Rod End
(Ø15*Ø17/M14*1.5)



FO1611
Upper Ball Joint
(Ø13.6)



FO1611
Upper Ball Joint
(Ø13.6)



FO1611
Upper Ball Joint
(Ø13.6)



FO1611
Upper Ball Joint
(Ø13.6)



LEFT

RIGHT

MAZDA

BT-50

FRONT

ALL MODELS

Year

2006-2012

FO1915
Lower Ball Joint
(Ø17.75)



FO2115
Lower Control Arm Bush



FO1915
Lower Ball Joint
(Ø17.75)



FO1917
Lower Ball Joint
(Ø19.5)



FO2022
Lower Control Arm

CA2110
Lower Control Arm Bush

FO2023
Lower Control Arm

FO1917
Lower Ball Joint
(Ø19.5)



FO1929
Lower Ball Joint
(Ø19.5)



FO2062
Lower Control Arm

CA2110
Lower Control Arm Bush

FO2063
Lower Control Arm

FO1929
Lower Ball Joint
(Ø19.5)



FO2411
Idler Arm
10 mm Hole



FO2412
Idler Arm
14 mm Hole



FO2413
Idler Arm
14 mm Hole / Opp Bracket



FO2510
Pitman Arm



LEFT

RIGHT

MAZDA

BT-50

FRONT

ALL MODELS

Year

2011-

FO1333
Outer Tie Rod End Set
(Ø14.3*Ø17.5/M14*1.5)

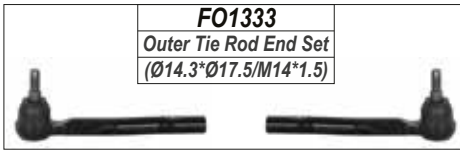

FO1334
Outer Tie Rod End Set
(Ø11.7*Ø14.6/M12*1.25)

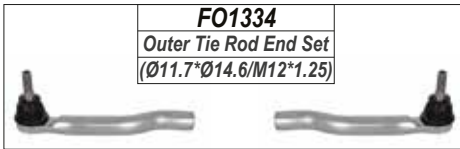

FO1047
Outer Tie Rod End
(Ø14.3*Ø17.5/M14*1.5)



FO1415
Rack End
(14*1.5/14*1.5/201)



FO1048
Outer Tie Rod End
(Ø14.3*Ø17.5/M14*1.5)



FO1049
Outer Tie Rod End
(Ø11.7*Ø14.6/M12*1.25)



FO1050
Outer Tie Rod End
(Ø11.7*Ø14.6/M12*1.25)



FO1535 / FO1536
Link Stabilizer
L=225.5



FO1812
Upper Control Arm Bush



FO1716
Upper Control Arm
(Long)

FO1717
Upper Control Arm
(Long)

FO1610
Upper Ball Joint
(Ø18)



FO1610
Upper Ball Joint
(Ø18)



FO1812
Upper Control Arm Bush



FO1724
Upper Control Arm
(Short)

FO1725
Upper Control Arm
(Short)

FO1930
Lower Ball Joint
(Ø21.35)



FO1930
Lower Ball Joint
(Ø21.35)



FO1812
Lower Control Arm Bush



FO2064
Lower Control Arm

FO2065
Lower Control Arm

LEFT

RIGHT

MAZDA

CX-3

FRONT

ALL MODELS

Year

2016-

MA1322

Inner Tie Rod End Set
($\varnothing 12.7 \times \varnothing 15.5 / M14 \times 1.5$)



MA1028

Outer Tie Rod End
($\varnothing 12.7 \times \varnothing 15.5 / M14 \times 1.5$)



MA1423

Rack End
($16 \times 1.5 / 14 \times 1.5 / 263$)



MA1028

Outer Tie Rod End
($\varnothing 12.7 \times \varnothing 15.5 / M14 \times 1.5$)



MA1529

Link Stabilizer
L=250



MA2128

Lower Control Arm Bush

MA1910

Lower Ball Joint
($\varnothing 20$)



MA1910

Lower Ball Joint
($\varnothing 20$)



MA2035

Lower Control Arm

MA2036

Lower Control Arm

MA2129

Lower Control Arm Bush

LEFT

RIGHT

MAZDA

CX-5

FRONT

ALL MODELS

Year

2011-

MA1319

Inner Tie Rod End Set
(Ø12.65*Ø15.5/M14*1.5)

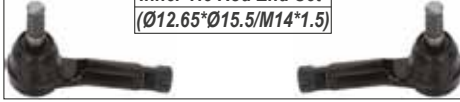

MA1020

Outer Tie Rod End
(Ø12.65*Ø15.5/M14*1.5)



MA1418

Rack End
(14*1.5/14*1.5/304)



MA1020

Outer Tie Rod End
(Ø12.65*Ø15.5/M14*1.5)



MA1520

Link Stabilizer
L=299



MA2114

Lower Control Arm Bush



MA1910

Lower Ball Joint
(Ø20)



MA1910

Lower Ball Joint
(Ø20)



MA2025

Lower Control Arm

MA2026

Lower Control Arm

MA2124 / MA2125

Lower Control Arm Bush



CX-5

REAR

MA1521 / MA1522

Link Stabilizer
L=150



LEFT

RIGHT

MAZDA

CX-7

FRONT

ALL MODELS

Year

2006-2012

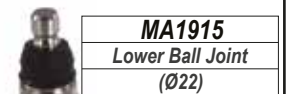
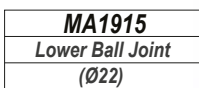
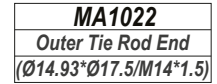
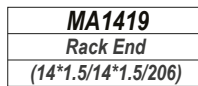
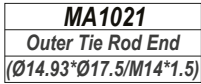

LEFT

RIGHT

MAZDA

ETUDE

FRONT

ALL MODELS

Year

1995-2000

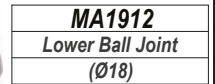
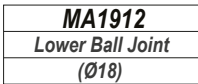
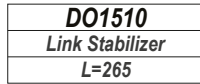
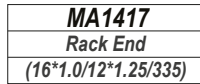
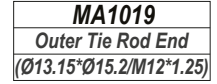
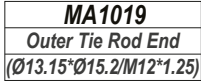
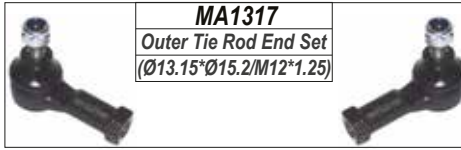

LEFT

RIGHT

MAZDA

ETUDE

FRONT

ALL MODELS

Year

1999-2004

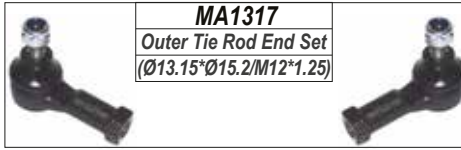

MA1317
Outer Tie Rod End Set
(Ø13.15*Ø15.2/M12*1.25)

MA1019
Outer Tie Rod End
(Ø13.15*Ø15.2/M12*1.25)



MA1420
Rack End
(16*1.0/14*1.5/310)



MA1019
Outer Tie Rod End
(Ø13.15*Ø15.2/M12*1.25)



MA1523
Link Stabilizer
L=190



DO1510
Link Stabilizer
L=265



MA2126
Lower Control Arm Bush



FO1932
Lower Ball Joint
(Ø18)



FO1932
Lower Ball Joint
(Ø18)



MA2029
Lower Control Arm

MA2030
Lower Control Arm

MA2817
Shock Mounting



MA2817
Shock Mounting



ETUDE

REAR

MA1524
Link Stabilizer
L=190



MA1525
Link Stabilizer
L=160



LEFT

RIGHT

MAZDA

MARATHON

FRONT

ALL MODELS

Year

1991-2004

F01019
Outer Tie Rod End
(Ø14*Ø16/M14*1.5)

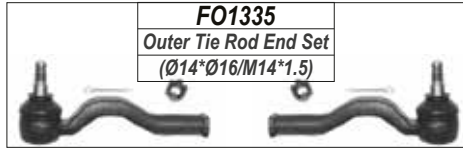

F01335
Outer Tie Rod End Set
(Ø14*Ø16/M14*1.5)

F01417
Rack End
(17*1.0/14*1.5/182)



F01019
Outer Tie Rod End
(Ø14*Ø16/M14*1.5)



F01612
Upper Ball Joint
(Ø17.85)



F01718
Upper Control Arm



F01719
Upper Control Arm



F01612
Upper Ball Joint
(Ø17.85)

F01931
Lower Ball Joint
(Ø19.75)



F02068
Lower Control Arm



F02069
Lower Control Arm



F01931
Lower Ball Joint
(Ø19.75)

LEFT

RIGHT

MAZDA

MX5

FRONT

ALL MODELS

Year

2001-2005

MA1023
Outer Tie Rod End
(Ø13*Ø15/M12*1.25)

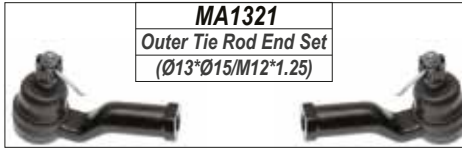

MA1321
Outer Tie Rod End Set
(Ø13*Ø15/M12*1.25)

MA1421
Rack End
(17*1.5/12*1.25/300)

MA1023
Outer Tie Rod End
(Ø13*Ø15/M12*1.25)



MA1526
Link Stabilizer
L=107



MA1527 / MA1528
Link Stabilizer
L=104



MA1714
Upper Control Arm

MA1715
Upper Control Arm

MA1914
Lower Ball Joint
(Ø15.75)



MA2031
Lower Control Arm



MA2032
Lower Control Arm

MA1914
Lower Ball Joint
(Ø15.75)



LEFT

RIGHT

MAZDA

MX6

FRONT

ALL MODELS

Year

1993-1998

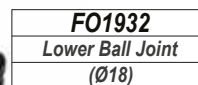
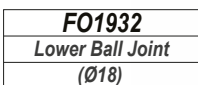
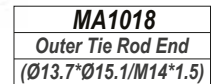
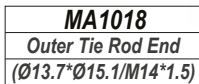
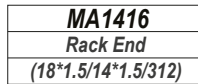
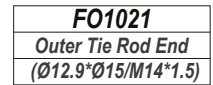
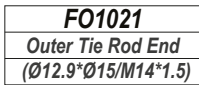
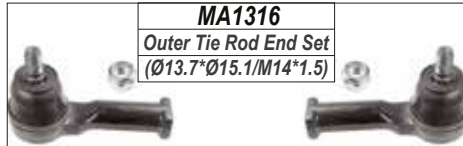
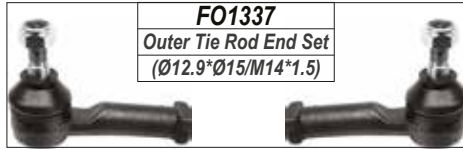

MX6

REAR

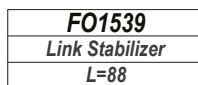

LEFT

RIGHT

MAZDA

RUSTLER

FRONT

ALL MODELS

Year

1983-1994

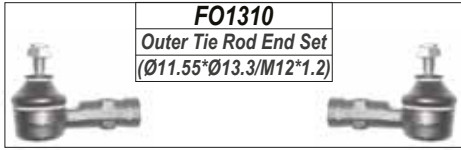

FO1310
Outer Tie Rod End Set
(Ø11.55*Ø13.3/M12*1.2)

FO1025
Outer Tie Rod End
(Ø11.55*Ø13.3/M12*1.2)

FO1421
Rack End
(14*1.5/12*20/290)

FO1025
Outer Tie Rod End
(Ø11.55*Ø13.3/M12*1.2)



FO1510
Link Stabilizer
L=239



FO2110
Lower Control Arm Bush

FO2111
Lower Control Arm Bush

FO2110
Lower Control Arm Bush



FO2010
Lower Control Arm
1983-1986

FO2011
Lower Control Arm
1983-1986

FO2110
Lower Control Arm Bush

FO2111
Lower Control Arm Bush

FO2110
Lower Control Arm Bush



FO2012
Lower Control Arm
1986-1994

FO2013
Lower Control Arm
1986-1994

FO2810
Stabilizer Bar Bush



FO2817
Shock Mounting



FO2811
Stabilizer Bar Bush



FO2817
Shock Mounting



LEFT

RIGHT

MAZDA

RUSTLER

FRONT

ALL MODELS

Year

1994-2002

FO1029
Outer Tie Rod End
(Ø13.2*Ø15.1/M12*1.25)

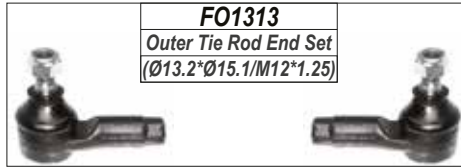

FO1313
Outer Tie Rod End Set
(Ø13.2*Ø15.1/M12*1.25)

FO1029
Outer Tie Rod End
(Ø13.2*Ø15.1/M12*1.25)



FO1422
Rack End(P/S)
(17*1.0/12*1.25/306)



FO1410
Rack End(M/S)
(14*1.5/12*1.5/305)



FO1511
Link Stabilizer
L=251



FO2145
Lower Control Arm Bush

FO1912
Lower Ball Joint
(Ø16)



FO2014
Lower Control Arm

FO2015
Lower Control Arm

FO1912
Lower Ball Joint
(Ø16)



FO2112
Lower Control Arm Bush



LEFT

RIGHT

MERCEDES
A209.C209 SERIES FRONT
CLK

Year

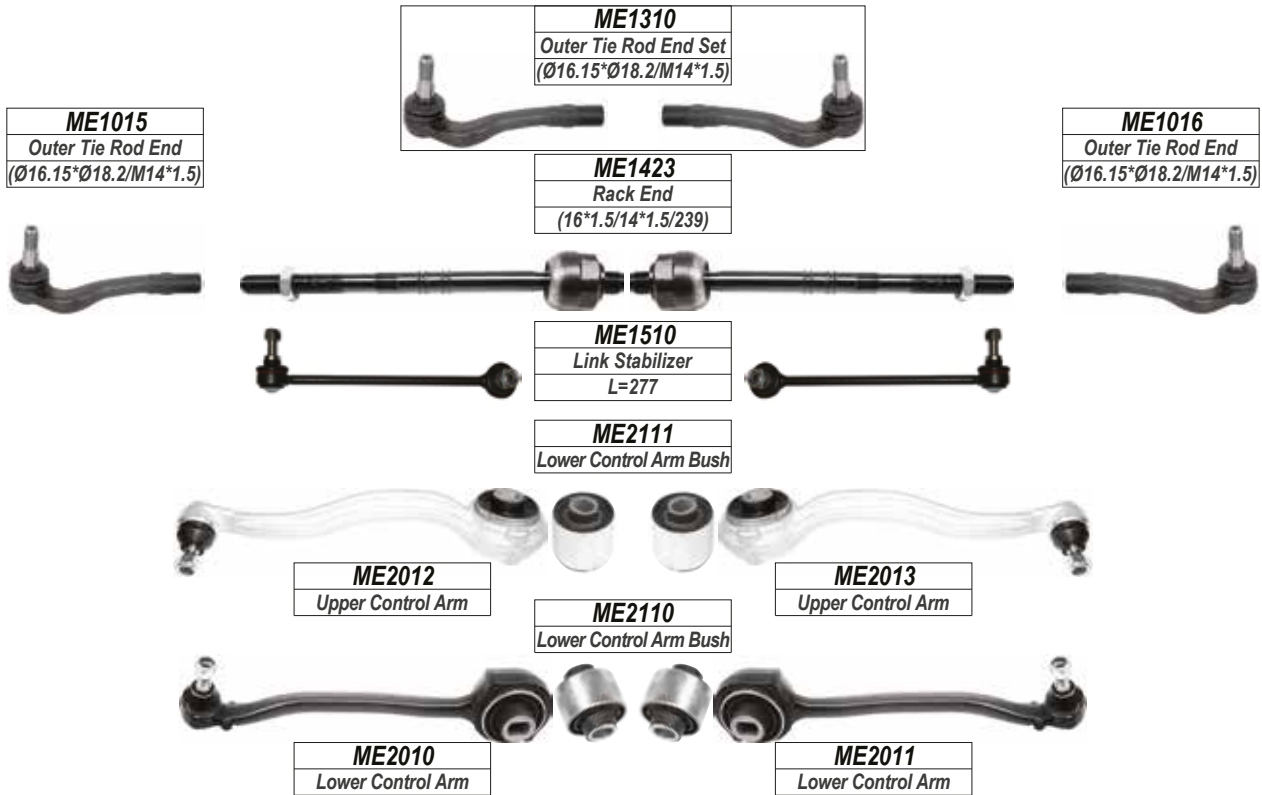
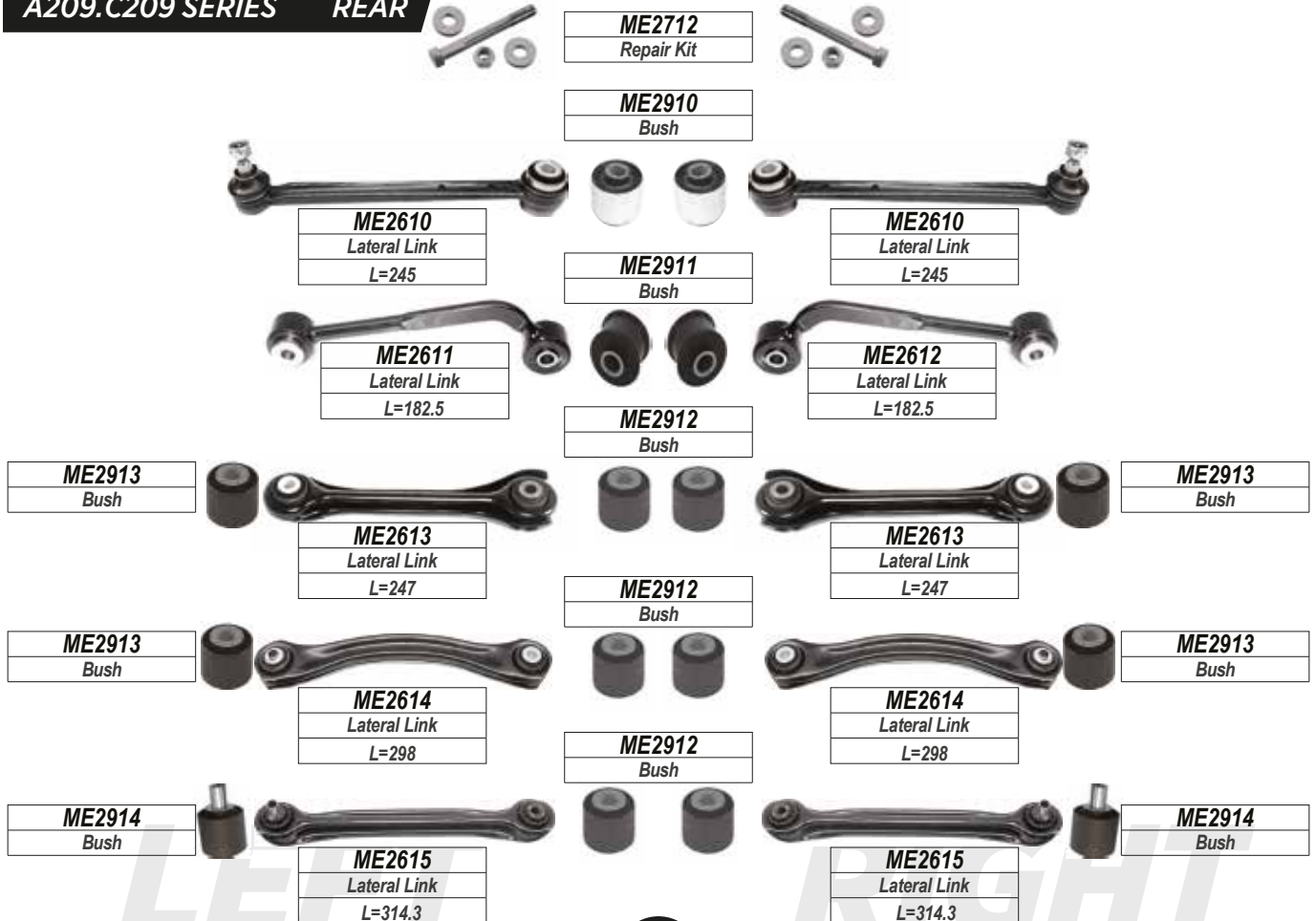
2002-2009

A209.C209 SERIES REAR

MERCEDES

C215 SERIES

FRONT

S.CL

Year

1996-2007

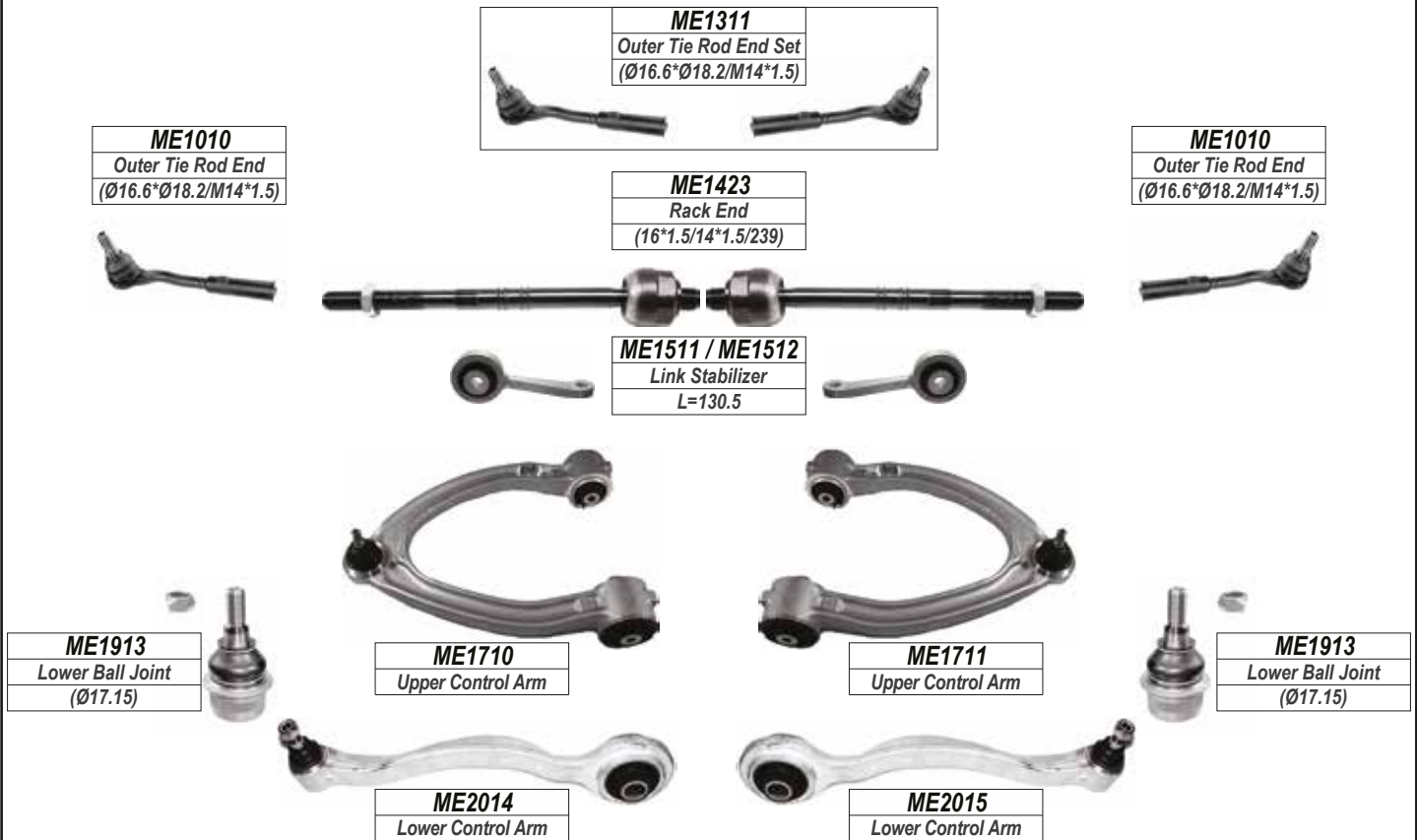

C215 SERIES

REAR

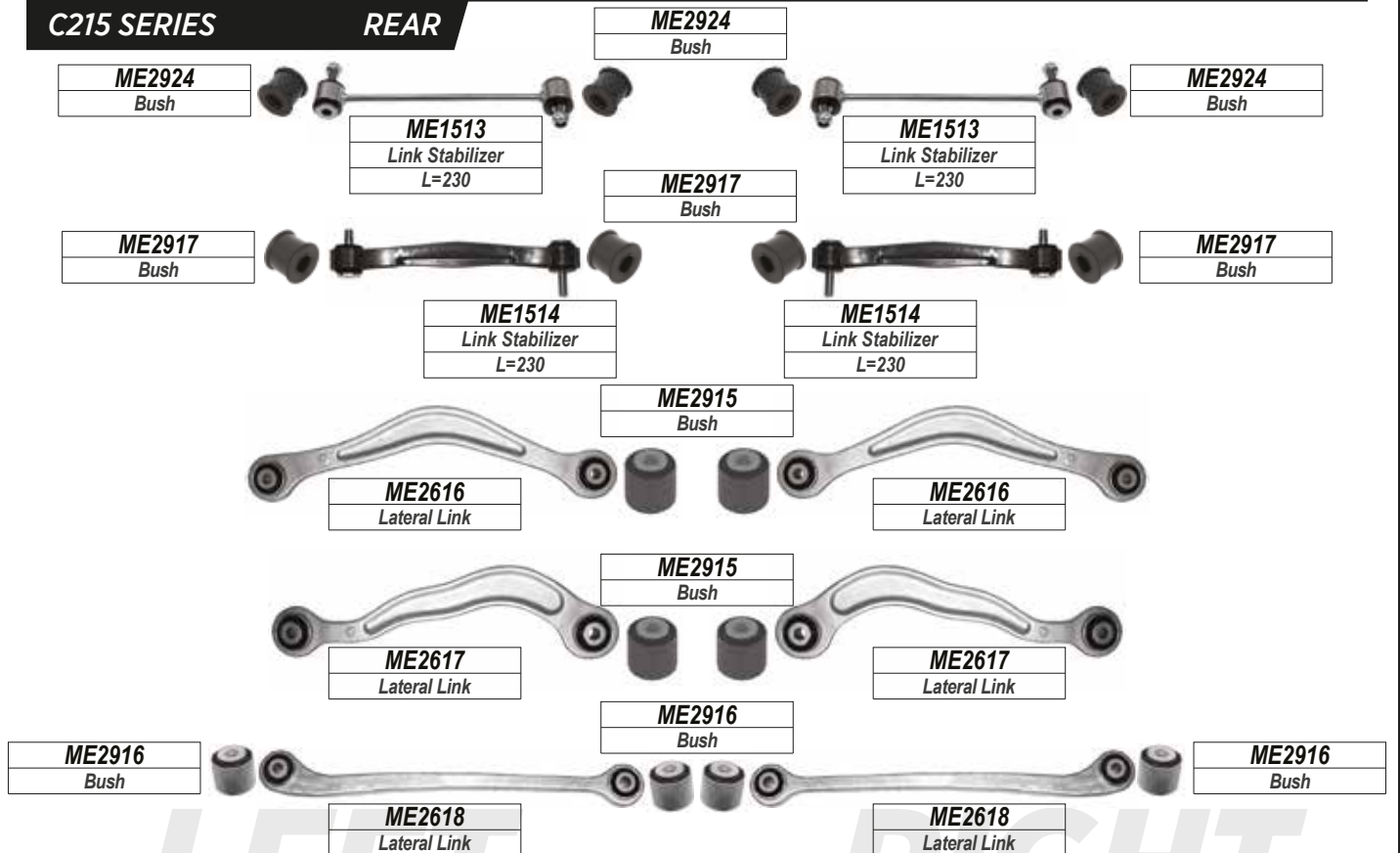

LEFT

RIGHT

MERCEDES

C219 SERIES

FRONT

CLS

Year

2004-2010

ME1313
Outer Tie Rod End Set
(Ø16.6*Ø18.2/M14*1.5)



ME1011
Outer Tie Rod End
(Ø16.6*Ø18.2/M14*1.5)



ME1423
Rack End
(16*1.5/14*1.5/239)



ME1012
Outer Tie Rod End
(Ø16.6*Ø18.2/M14*1.5)



ME1515 / ME1516
Link Stabilizer
L=128.5



ME1816
Upper Control Arm Bush



ME1610
Upper Ball Joint
(Ø13)



ME1610
Upper Ball Joint
(Ø13)



ME1712
Upper Control Arm

ME1914
Lower Ball Joint
(Ø22)



ME1713
Upper Control Arm

ME1914
Lower Ball Joint
(Ø22)



ME1913
Lower Ball Joint
(Ø17.15)

ME2113
Lower Control Arm Bush



ME1913
Lower Ball Joint
(Ø17.15)

ME2114
Lower Control Arm Bush

ME2018
Lower Control Arm

ME2019
Lower Control Arm

ME2114
Lower Control Arm Bush

ME2112
Lower Control Arm Bush



ME2016
Lower Control Arm

ME2017
Lower Control Arm

LEFT

RIGHT

MERCEDES

C219 SERIES

REAR

CLS

Year

2004-2010

ME2917

Bush



ME1517

Link Stabilizer

L=259.5

ME1517

Link Stabilizer

L=259.5

ME2916

Bush



ME2621

Lateral Link

ME2621

Lateral Link

ME2920

Bush



ME2624

Lateral Link

ME2625

Lateral Link

ME2919

Bush

ME2918

Bush



ME2622

Lateral Link

ME2623

Lateral Link

ME2918

Bush



ME2619

Lateral Link



ME2620

Lateral Link

LEFT

RIGHT

MERCEDES

R129 SERIES

FRONT

SL

Year

1993-2001



ME2213
Center Rod

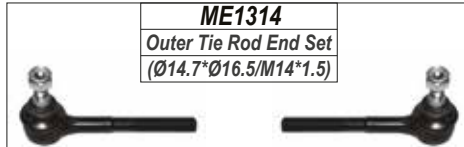

ME1314
Outer Tie Rod End Set
(Ø14.7*Ø16.5/M14*1.5)

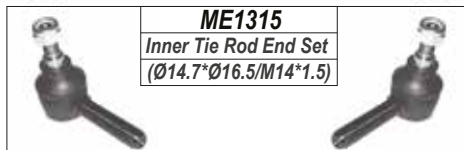

ME1315
Inner Tie Rod End Set
(Ø14.7*Ø16.5/M14*1.5)

ME1013
Outer Tie Rod End
(Ø14.7*Ø16.5/M14*1.5)



ME1110
Inner Tie Rod End
(Ø14.7*Ø16.5/M14*1.5)



ME1013
Outer Tie Rod End
(Ø14.7*Ø16.5/M14*1.5)



ME1210
Tie Rod Assembly



ME1915
Lower Ball Joint
(Ø18)



ME2020
Lower Control Arm
<CH;12408

ME2713
Repair Kit

ME2020
Lower Control Arm
<CH;12408

ME1915
Lower Ball Joint
(Ø18)



ME1916
Lower Ball Joint
(Ø20)



ME2022
Lower Control Arm
CH;12408>

ME2713
Repair Kit

ME2023
Lower Control Arm
CH;12408>

ME1917
Lower Ball Joint
(Ø20)

ME2816
Stabilizer Bar Bush



ME2816
Stabilizer Bar Bush



LEFT

RIGHT

MERCEDES

R129 SERIES

REAR

SL

Year

1993-2001

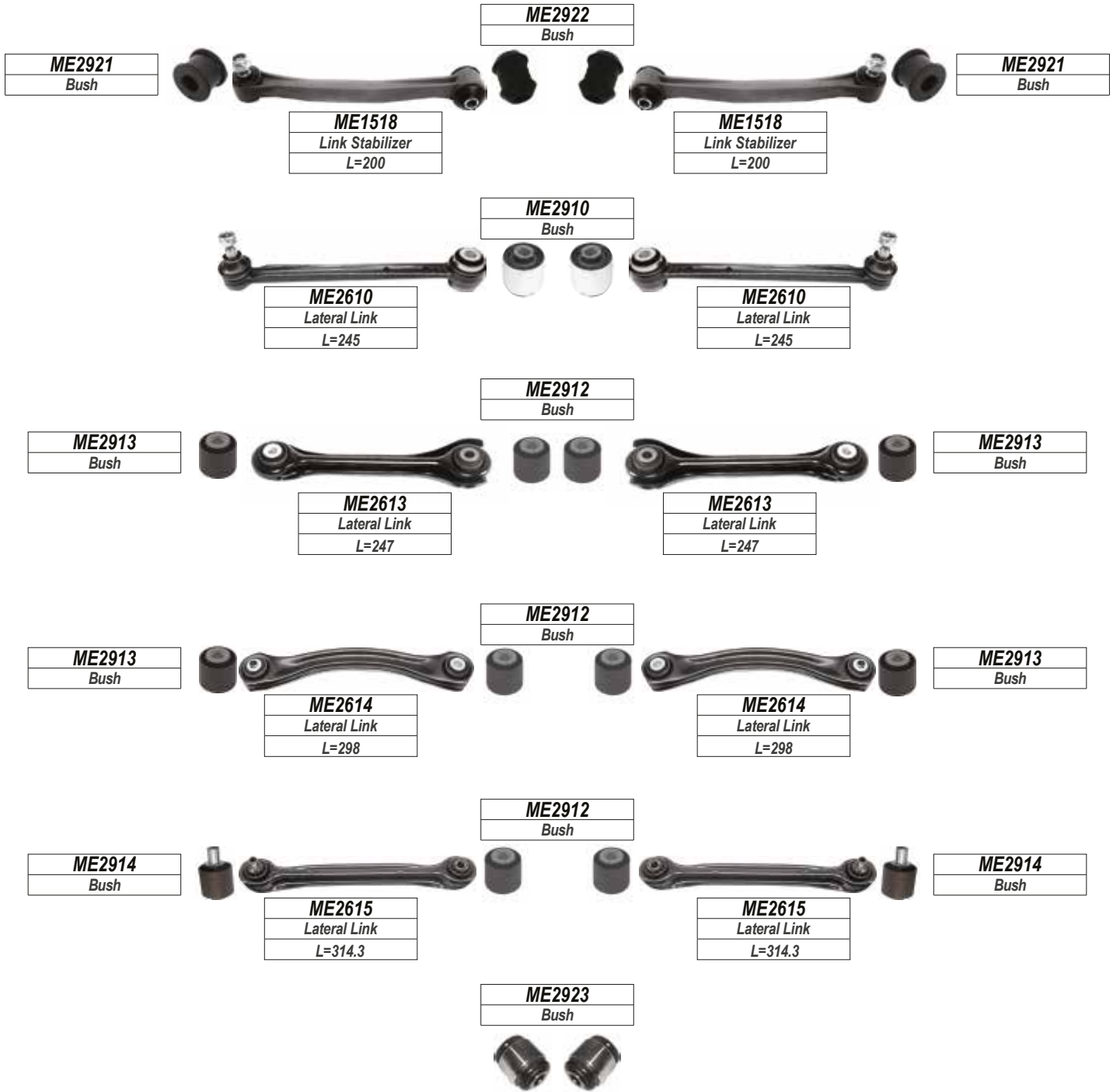

LEFT

RIGHT

MERCEDES

R170 SERIES

FRONT

SLK

Year

1997-2004

ME2214
Center Rod
Only 4 Cylinder



ME2215
Center Rod
Only 6 Cylinder

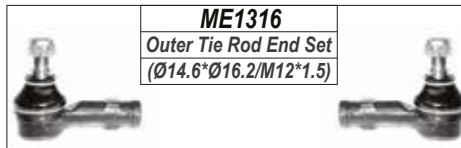

ME1316
Outer Tie Rod End Set
(Ø14.6*Ø16.2/M12*1.5)

ME1014
Outer Tie Rod End
(Ø14.6*Ø16.2/M12*1.5)



ME1014
Outer Tie Rod End
(Ø14.6*Ø16.2/M12*1.5)



ME1714
Upper Control Arm

ME1810
Upper Control Arm Bush

ME1715
Upper Control Arm

ME2714
Repair Kit

ME2115
Lower Control Arm Bush

ME1910
Lower Ball Joint
(Ø16)



ME2024
Lower Control Arm



ME2025
Lower Control Arm

ME1910
Lower Ball Joint
(Ø16)



LEFT

RIGHT

MERCEDES

R170 SERIES

REAR

SLK

Year

1997-2004

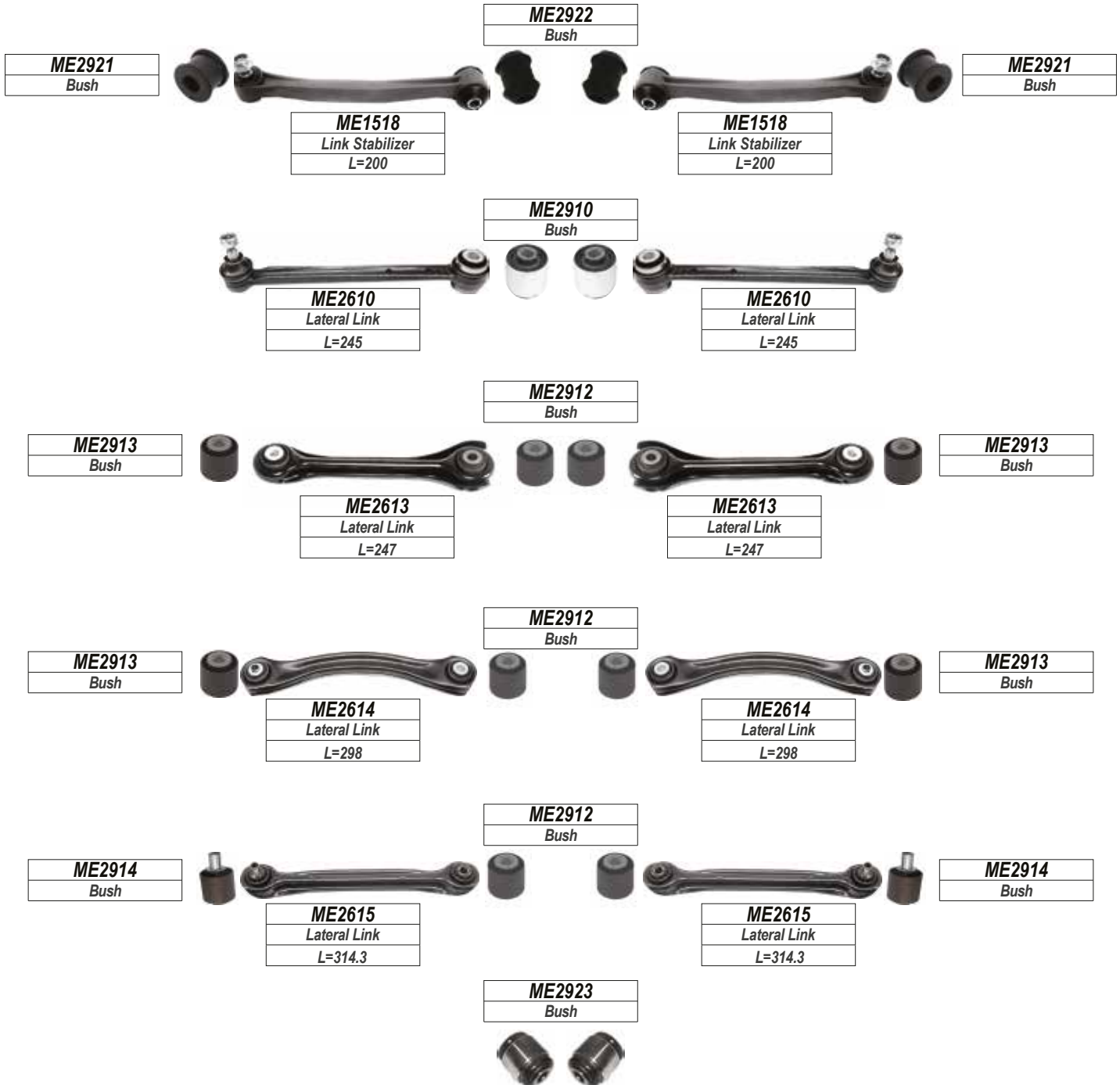

LEFT

RIGHT

MERCEDES

R171 SERIES

FRONT

SLK

Year

2004-2011

ME1015
Outer Tie Rod End
(Ø16.15*Ø18.2/M14*1.5)

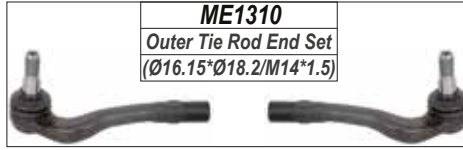

ME1310
Outer Tie Rod End Set
(Ø16.15*Ø18.2/M14*1.5)

ME1424
Rack End
(16*1.5/14*1.5/264)



ME1016
Outer Tie Rod End
(Ø16.15*Ø18.2/M14*1.5)



ME1519
Link Stabilizer
L=276



ME1520
Link Stabilizer
L=255



ME2111
Lower Control Arm Bush



ME2012
Upper Control Arm

ME2013
Upper Control Arm



ME2110
Lower Control Arm Bush



ME2010
Lower Control Arm

ME2011
Lower Control Arm

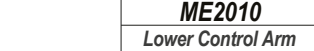

LEFT

RIGHT

MERCEDES

R171 SERIES

REAR

SLK

Year

2004-2011

ME2922

Bush

ME2921

Bush

ME2921

Bush

ME1518

Link Stabilizer

L=200

ME1518

Link Stabilizer

L=200

ME2910

Bush

ME2610

Lateral Link

L=245

ME2610

Lateral Link

L=245

ME2912

Bush

ME2913

Bush

ME2913

Bush

ME2613

Lateral Link

L=247

ME2613

Lateral Link

L=247

ME2912

Bush

ME2913

Bush

ME2913

Bush

ME2614

Lateral Link

L=298

ME2614

Lateral Link

L=298

ME2912

Bush

ME2914

Bush

ME2914

Bush

ME2615

Lateral Link

L=314.3

ME2615

Lateral Link

L=314.3

ME2923

Bush

LEFT

RIGHT

MERCEDES

R172 SERIES

FRONT

SLK

Year

2011-2016

ME1017
Outer Tie Rod End
(Ø16.15*Ø18.2/M14*1.5)

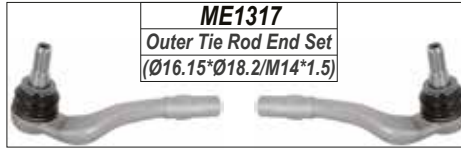

ME1317
Outer Tie Rod End Set
(Ø16.15*Ø18.2/M14*1.5)

ME1018
Outer Tie Rod End
(Ø16.15*Ø18.2/M14*1.5)



ME1425
Rack End
(16*1.5/14*1.5/264)



ME1521 / ME1522
Link Stabilizer
L=257

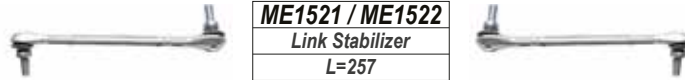

ME2116
Lower Control Arm Bush



ME2026
Lower Control Arm



ME2027
Lower Control Arm



ME2028
Lower Control Arm



ME2029
Lower Control Arm



C172 SERIES

REAR

ME2922
Bush



ME2924
Bush



ME2924
Bush

ME2626
Lateral Link



ME2626
Lateral Link



ME2910
Bush

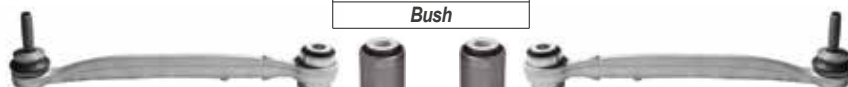

ME2627
Lateral Link

ME2627
Lateral Link

ME2925
Bush



ME2913
Bush



ME2628
Lateral Link



ME2925
Bush



ME2629
Lateral Link



ME2913
Bush

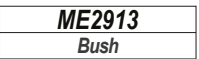

ME2913
Bush



ME2630
Lateral Link



ME2925
Bush



ME2630
Lateral Link



ME2913
Bush



ME2913
Bush



ME2631
Lateral Link



ME2925
Bush



ME2631
Lateral Link



ME2913
Bush



LEFT

RIGHT

MERCEDES

R 230 SERIES

FRONT

SL

Year

2002-2012

ME1010
Outer Tie Rod End
(Ø16.6*Ø18.2/M14*1.5)

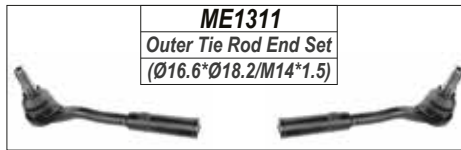

ME1311
Outer Tie Rod End Set
(Ø16.6*Ø18.2/M14*1.5)

ME1423
Rack End
(16*1.5/14*1.5/239)



ME1010
Outer Tie Rod End
(Ø16.6*Ø18.2/M14*1.5)



ME1523 / ME1524
Link Stabilizer
L=174



ME1610
Upper Ball Joint
(Ø13)



ME1816
Upper Control Arm Bush



ME1610
Upper Ball Joint
(Ø13)

ME1712
Upper Control Arm



ME1713
Upper Control Arm



ME1914
Lower Ball Joint
(Ø22)



ME1914
Lower Ball Joint
(Ø22)

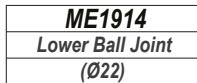

ME1913
Lower Ball Joint
(Ø17.15)



ME2113
Lower Control Arm Bush



ME1913
Lower Ball Joint
(Ø17.15)



ME2114
Lower Control Arm Bush



ME2018
Lower Control Arm



ME2019
Lower Control Arm



ME2114
Lower Control Arm Bush



ME2112
Lower Control Arm Bush



ME2016
Lower Control Arm



ME2017
Lower Control Arm



LEFT

RIGHT

MERCEDES

R 230 SERIES

REAR

CLS

Year

2002-2012

ME2917

Bush



ME1517

Link Stabilizer

L=259.5

ME1517

Link Stabilizer

L=259.5

ME2916

Bush



ME2621

Lateral Link

ME2621

Lateral Link

ME2920

Bush



ME2624

Lateral Link

ME2625

Lateral Link

ME2919

Bush

ME2918

Bush



ME2622

Lateral Link

ME2623

Lateral Link

ME2918

Bush



ME2619

Lateral Link



ME2620

Lateral Link

LEFT

RIGHT

MERCEDES

W116 SERIES

FRONT

S CLASS

Year

1973-1981

ME2216

Center Rod

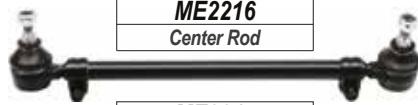

ME2217

Center Rod



ME1318

Outer Tie Rod End Set
(Ø12.6*Ø14.2/M14*1.5)

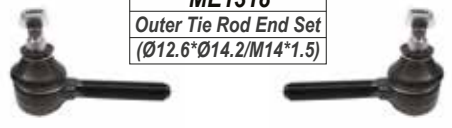

ME1319

Inner Tie Rod End Set
(Ø14.6*Ø16.2/M12*1.5)

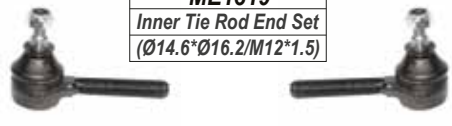

ME1019

Outer Tie Rod End
(Ø12.6*Ø14.2/M14*1.5)



ME1111

Inner Tie Rod End
(Ø14.6*Ø16.2/M12*1.5)



ME1019

Outer Tie Rod End
(Ø12.6*Ø14.2/M14*1.5)



ME1525

Link Stabilizer
L=108



ME1811

Upper Control Arm Bush



ME1716

Upper Control Arm

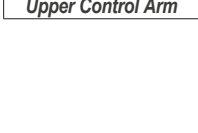

ME1717

Upper Control Arm

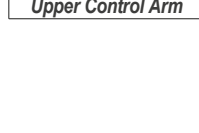

ME1918

Lower Ball Joint
(Ø18.2)



ME2926

Bush



ME1918

Lower Ball Joint
(Ø18.2)



ME2717

Repair Kit



W116 SERIES

REAR

ME1526

Link Stabilizer
L=100.5



LEFT

RIGHT

MERCEDES

W123 SERIES

FRONT

ALL MODEL

Year

1977-1986

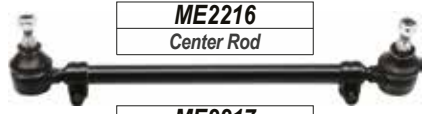

ME2216
Center Rod



ME2217
Center Rod

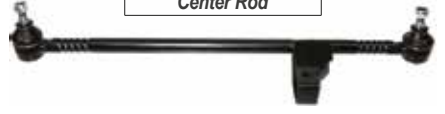

ME2218
Center Rod

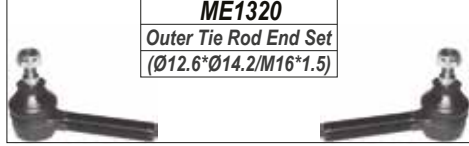

ME1320
Outer Tie Rod End Set
(Ø12.6*Ø14.2/M16*1.5)

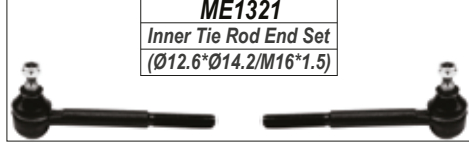

ME1321
Inner Tie Rod End Set
(Ø12.6*Ø14.2/M16*1.5)

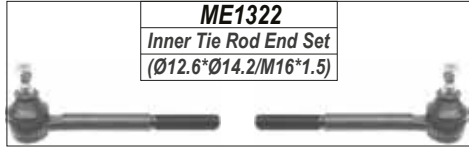

ME1322
Inner Tie Rod End Set
(Ø12.6*Ø14.2/M16*1.5)



ME1114
Inner Tie Rod End
(Ø12.6*Ø14.2/M16*1.5)



ME1115
Inner Tie Rod End
(Ø12.6*Ø14.2/M16*1.5)



ME1525
Link Stabilizer
L=108

ME1020
Outer Tie Rod End
(Ø12.6*Ø14.2/M16*1.5)



ME1020
Outer Tie Rod End
(Ø12.6*Ø14.2/M16*1.5)



LEFT

RIGHT

MERCEDES

W123 SERIES

FRONT

ALL MODEL

Year

1977-1986



ME1811
Upper Control Arm Bush

ME1716
Upper Control Arm

ME1717
Upper Control Arm



ME1918
Lower Ball Joint
(Ø18.2)



ME1918
Lower Ball Joint
(Ø18.2)

ME2926
Bush



ME2717
Repair Kit



W123 SERIES

REAR

ME1526
Link Stabilizer
L=100.5



LEFT

RIGHT

MERCEDES

W124 SERIES

FRONT

ALL MODEL

Year

1986-1996

ME2219

Center Rod



ME2220

Center Rod

Ø14.5*Ø16

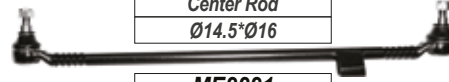

ME2221

Center Rod

Ø12.5*Ø14

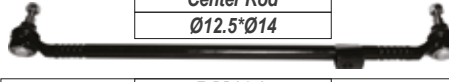

BM1317

Outer Tie Rod End Set

(Ø12.6*Ø14.2/M14*1.5)

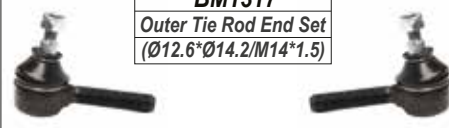

ME1323

Inner Tie Rod End Set

(Ø12.6*Ø14.2/M14*1.5)

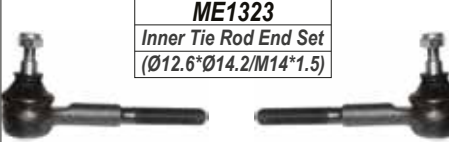

BM1026

Outer Tie Rod End

(Ø12.6*Ø14.2/M14*1.5)



ME1116

Inner Tie Rod End

(Ø12.6*Ø14.2/M14*1.5)



BM1026

Outer Tie Rod End

(Ø12.6*Ø14.2/M14*1.5)



ME1915

Lower Ball Joint

(Ø18)



ME2713

Repair Kit



ME1915

Lower Ball Joint

(Ø18)



ME2020

Lower Control Arm



ME2021

Lower Control Arm



ME1916

Lower Ball Joint

(Ø20)



ME2713

Repair Kit



ME1917

Lower Ball Joint

(Ø20)



ME2022

Lower Control Arm



ME2023

Lower Control Arm



ME2827

Shock Mounting



ME2816

Stabilizer Bar Bush

ID:18.5



ME2817

Stabilizer Bar Bush

ID:24



ME2827

Shock Mounting



LEFT

RIGHT

MERCEDES

W124 SERIES

REAR

ALL MODEL

Year

1986-1996

ME2927

Bush

ME1527

Link Stabilizer

L=200

ME1527

Link Stabilizer

L=200

ME2921

Bush

ME2922

Bush

ME2921

Bush

ME1518

Link Stabilizer

L=200

ME1518

Link Stabilizer

L=200

ME2910

Bush

ME2610

Lateral Link

L=245

ME2610

Lateral Link

L=245

ME2913

Bush

ME2912

Bush

ME2913

Bush

ME2613

Lateral Link

L=247

ME2613

Lateral Link

L=247

ME2913

Bush

ME2912

Bush

ME2913

Bush

ME2614

Lateral Link

L=298

ME2614

Lateral Link

L=298

ME2914

Bush

ME2912

Bush

ME2914

Bush

ME2615

Lateral Link

L=314.3

ME2615

Lateral Link

L=314.3

ME2923

Bush

ME2928

Bush

LEFT

RIGHT

MERCEDES

W126 SERIES

FRONT

ALL MODEL

Year

1981-1993

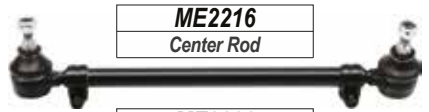

ME2216
Center Rod

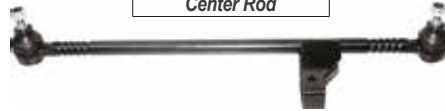

ME2222
Center Rod

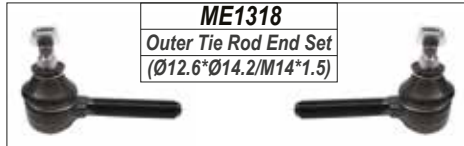

ME1318
Outer Tie Rod End Set
(Ø12.6*Ø14.2/M14*1.5)

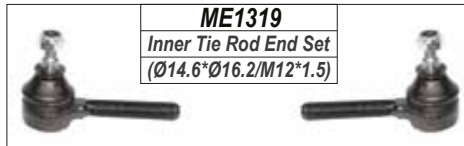

ME1319
Inner Tie Rod End Set
(Ø14.6*Ø16.2/M12*1.5)

ME1019
Outer Tie Rod End
(Ø12.6*Ø14.2/M14*1.5)



ME1111
Inner Tie Rod End
(Ø14.6*Ø16.2/M12*1.5)



ME1019
Outer Tie Rod End
(Ø12.6*Ø14.2/M14*1.5)



ME1525
Link Stabilizer
L=108



ME1812
Upper Control Arm Bush

ME1718
Upper Control Arm



ME1719
Upper Control Arm

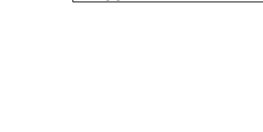

ME2926
Bush



ME2717
Repair Kit



ME1918
Lower Ball Joint
(Ø18.2)



ME1918
Lower Ball Joint
(Ø18.2)



ME1919
Lower Ball Joint
(Ø21)



ME1919
Lower Ball Joint
(Ø21)



W126 SERIES

REAR

ME2913
Bush



ME1526
Link Stabilizer
L=100.5



ME2913
Bush



LEFT

RIGHT

MERCEDES

W140 SERIES

FRONT

S CLASS

Year

1993-2000

ME2210

Center Rod



ME1324

Outer Tie Rod End Set
(Ø14.2*Ø16.2/M16*1.5)

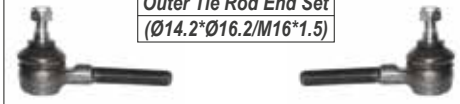

ME1325

Inner Tie Rod End Set
(Ø14.2*Ø16.2/M16*1.5)



ME1021

Outer Tie Rod End
(Ø14.2*Ø16.2/M16*1.5)



ME1112

Inner Tie Rod End
(Ø14.2*Ø16.2/M16*1.5)



ME1021

Outer Tie Rod End
(Ø14.2*Ø16.2/M16*1.5)



ME1528 / ME1529

Link Stabilizer
L=152



ME1720

Upper Control Arm



ME1721

Upper Control Arm



ME1920

Lower Ball Joint
(Ø17.8)



ME1920

Lower Ball Joint
(Ø17.8)



LEFT

RIGHT

MERCEDES

R140 SERIES

REAR

S CLASS

Year

1993-2000

ME1530
Link Stabilizer
L=230



ME2924
Bush

ME2924
Bush



ME1513
Link Stabilizer
L=230



ME2924
Bush

ME1513
Link Stabilizer
L=230

ME2917
Bush

ME2917
Bush



ME1514
Link Stabilizer
L=230



ME2917
Bush

ME1514
Link Stabilizer
L=230

ME2929
Bush

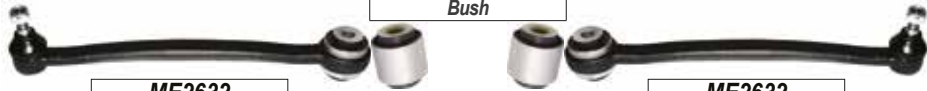

ME2632
Lateral Link
L=290

ME2632
Lateral Link
L=290

ME2930
Bush

ME2931
Bush



ME2633
Lateral Link



ME2931
Bush

ME2633
Lateral Link

ME2932
Bush

ME2931
Bush



ME2634
Lateral Link



ME2931
Bush

ME2634
Lateral Link

ME2932
Bush

ME2931
Bush



ME2635
Lateral Link



ME2931
Bush

ME2635
Lateral Link

ME2923
Bush



LEFT

RIGHT

MERCEDES

W163 SERIES

FRONT

ML

Year

1998-2005

ME1326
Outer Tie Rod End Set
(Ø15.1*Ø18.1/M16*1.5)

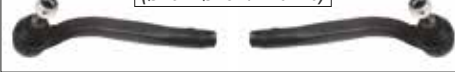

ME1022
Outer Tie Rod End
(Ø15.1*Ø18.1/M16*1.5)



ME1410
Rack End
(16*1.5/16*1.5/160)



ME1023
Outer Tie Rod End
(Ø15.1*Ø18.1/M16*1.5)



ME1531 / ME1532
Link Stabilizer
L=128



ME1813
Upper Control Arm Bush



ME1722
Upper Control Arm

ME1723
Upper Control Arm

ME2117
Lower Control Arm Bush



ME2118
Lower Control Arm Bush

ME1911
Lower Ball Joint
(Ø19.9)



ME1911
Lower Ball Joint
(Ø19.9)



ME1912
Lower Ball Joint
(Ø16.2)



ME1912
Lower Ball Joint
(Ø16.2)



ME2030
Lower Control Arm

ME2031
Lower Control Arm

LEFT

RIGHT

MERCEDES

W163 SERIES

REAR

ML

Year

1998-2005

ME1533
Link Stabilizer
L=222



ME1724
Upper Control Arm

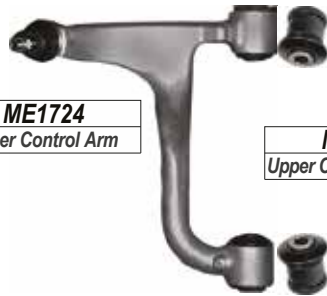

ME1813
Upper Control Arm Bush

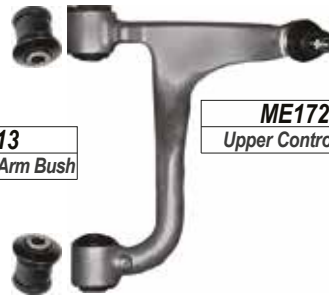

ME1725
Upper Control Arm

ME2933
Bush



ME2636
Lateral Link
L=378

ME2637
Lateral Link
L=378

LEFT

RIGHT

MERCEDES

W164-X164 SERIES FRONT

ML/GL CLASS

Year

2005-2012

ME1024
Outer Tie Rod End
(Ø15*Ø18.9/M14*1.5)

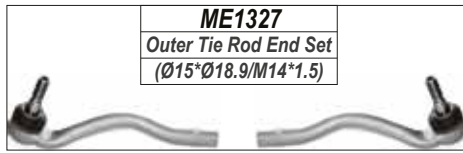

ME1327
Outer Tie Rod End Set
(Ø15*Ø18.9/M14*1.5)

ME1411
Rack End
(16*1.5/14*1.5/202)



ME1025
Outer Tie Rod End
(Ø15*Ø18.9/M14*1.5)



ME1534
Link Stabilizer
L=195.5



ME1814
Upper Control Arm Bush



ME1726
Upper Control Arm

ME1727
Upper Control Arm

ME2121
Lower Control Arm Bush

ME2121
Lower Control Arm Bush

ME2122
Lower Control Arm Bush



ME2119 / ME2120
Lower Control Arm Bush

ME2032
Lower Control Arm

ME2033
Lower Control Arm

ME1921
Lower Ball Joint
(Ø19.3)



ME1921
Lower Ball Joint
(Ø19.3)



ME1922
Lower Ball Joint
(Ø19.3)



ME1922
Lower Ball Joint
(Ø19.3)



LEFT

RIGHT

MERCEDES

W164-X164 SERIES REAR

ML/GL CLASS

Year

2005-2012

ME1535
Link Stabilizer
L=117



ME2931
Bush

ME2934
Bush



ME2934
Bush

ME2638
Lateral Link

ME2638
Lateral Link

ME2931
Bush

ME2934
Bush



ME2934
Bush

ME2639
Lateral Link

ME2640
Lateral Link

LEFT

RIGHT

MERCEDES

W166-X166 SERIES FRONT

ML/GL CLASS

Year

2012-

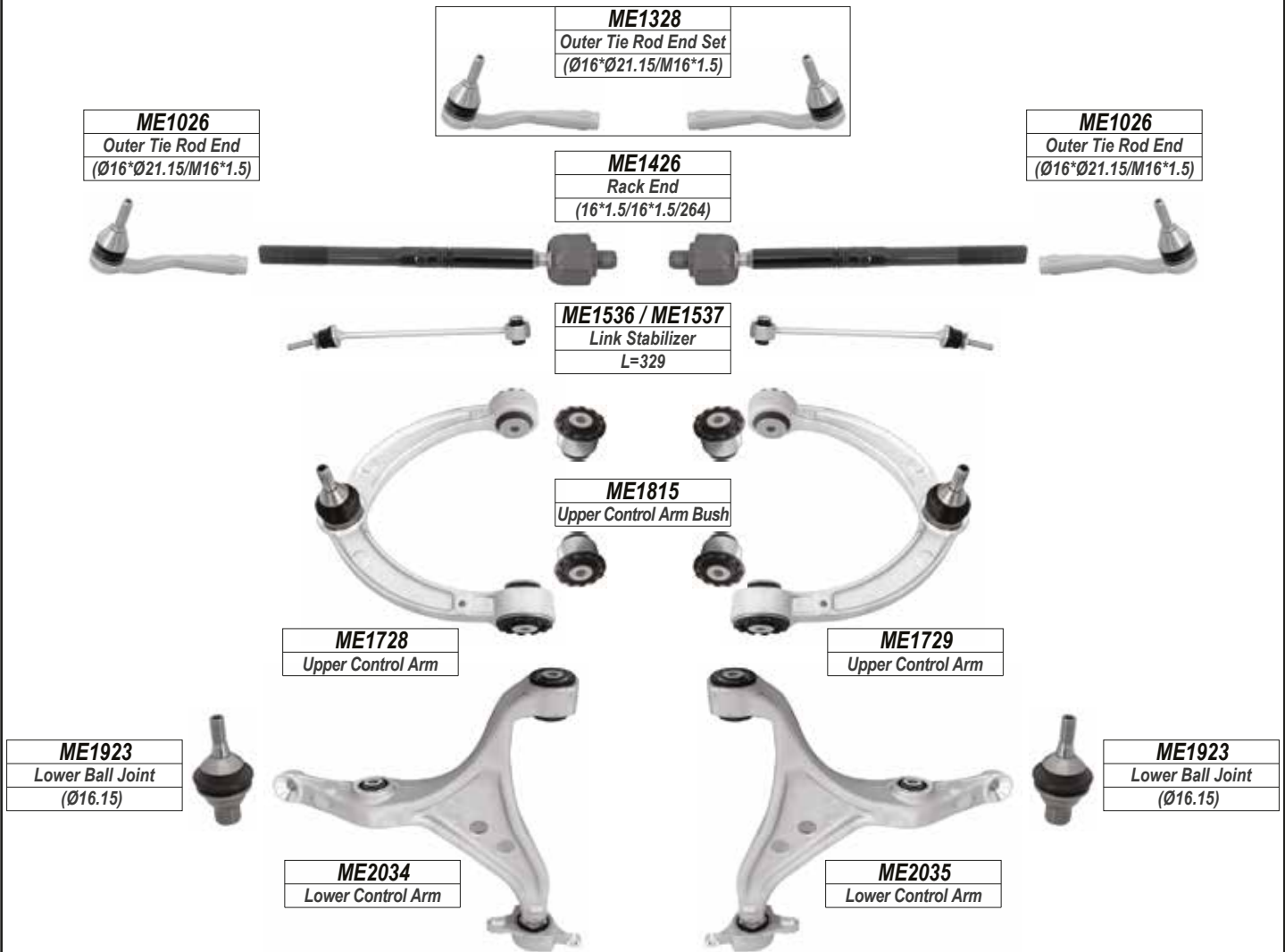

W166-X166 SERIES REAR



LEFT

RIGHT

MERCEDES

W168 SERIES

FRONT

A CLASS

Year

2000-2005

ME1329
Outer Tie Rod End Set
(Ø14.7*Ø16.4/M12*1.5)



ME1027
Outer Tie Rod End
(Ø14.7*Ø16.4/M12*1.5)



ME1412
Rack End
(14*1.5/12*1.5/197)



ME1028
Outer Tie Rod End
(Ø14.7*Ø16.4/M12*1.5)



ME1538
Link Stabilizer
L=220



ME2123
Lower Control Arm Bush



ME1924
Lower Ball Joint
(Ø13.7)

ME1924
Lower Ball Joint
(Ø13.7)

ME2036
Lower Control Arm

ME2037
Lower Control Arm

ME2124
Lower Control Arm Bush

ME2828
Shock Mounting



ME2828
Shock Mounting



LEFT

RIGHT

MERCEDES

W169 SERIES

FRONT

A CLASS

Year

2005-2013

ME1330
Outer Tie Rod End Set
(Ø16.7*Ø18.3/M14*1.5)



ME1029
Outer Tie Rod End
(Ø16.7*Ø18.3/M14*1.5)



ME1413
Rack End
(14*1.5/14*1.5/201)



ME1030
Outer Tie Rod End
(Ø16.7*Ø18.3/M14*1.5)



ME1539
Link Stabilizer
L=244



ME1540
Link Stabilizer
L=244.5



ME2125
Lower Control Arm Bush



ME1925
Lower Ball Joint
(Ø15.5)



ME1925
Lower Ball Joint
(Ø15.5)



ME2038
Lower Control Arm

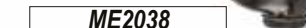

ME2126
Lower Control Arm Bush



ME2039
Lower Control Arm



ME2829
Shock Mounting



ME2829
Shock Mounting



W169 SERIES

REAR

ME2935
Bush



ME1541
Link Stabilizer
L=87



ME1541
Link Stabilizer
L=87



LEFT

RIGHT

MERCEDES

W176 SERIES

FRONT

A CLASS

Year

2012-

ME1031
Outer Tie Rod End
(Ø16.3*Ø20.2/M14*1.5)



ME1331
Outer Tie Rod End Set
(Ø16.3*Ø20.2/M14*1.5)

ME1427
Rack End
(14*1.5/14*1.5/222)



ME1032
Outer Tie Rod End
(Ø16.3*Ø20.2/M14*1.5)



ME1542
Link Stabilizer
L=333



ME2129
Lower Control Arm Bush



ME2040
Lower Control Arm



ME2041
Lower Control Arm



ME2830
Shock Mounting
W/Out Sports Package



ME2127 / ME2128
Lower Control Arm Bush



ME2830
Shock Mounting
W/Out Sports Package



ME2831
Shock Mounting
With Sports Package



ME2831
Shock Mounting
With Sports Package



W176 SERIES

REAR



ME2936
Bush

ME1543
Link Stabilizer
L=79

ME1543
Link Stabilizer
L=79

LEFT

RIGHT

MERCEDES

W201 SERIES

FRONT

100-CLASS (190E)

Year

1984-1994

ME2211

Center Rod



ME2212

Center Rod



ME1332

Outer Tie Rod End Set
(Ø12.6*Ø14.2/M14*1.5)

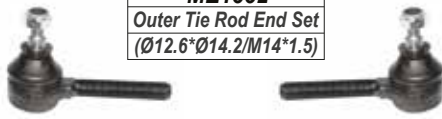

ME1333

Inner Tie Rod End Set
(Ø12.6*Ø14.2/M14*1.5)

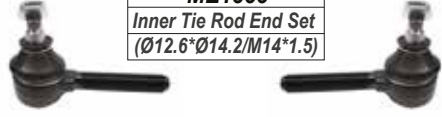

ME1033

Outer Tie Rod End
(Ø12.6*Ø14.2/M14*1.5)



ME1113

Inner Tie Rod End Set
(Ø12.6*Ø14.2/M14*1.5)



ME1033

Outer Tie Rod End
(Ø12.6*Ø14.2/M14*1.5)



ME1544

Link Stabilizer
L=120

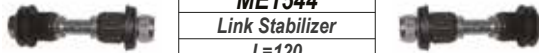

ME1915

Lower Ball Joint
(Ø18)



ME2713

Repair Kit



ME1915

Lower Ball Joint
(Ø18)



ME2042

Lower Control Arm



ME2043

Lower Control Arm



ME2818

Stabilizer Bar Bush
(Ø24)



ME2937

Bush



ME2819

Stabilizer Bar Bush
(Ø25)



LEFT

RIGHT

MERCEDES

R201 SERIES

REAR

100-CLASS (190E)

Year

1984-1994

ME2921

Bush

ME2922

Bush

ME2921

Bush



ME1518

Link Stabilizer

L=200

ME1518

Link Stabilizer

L=200

ME2910

Bush



ME2610

Lateral Link

L=245

ME2610

Lateral Link

L=245

ME2913

Bush

ME2912

Bush

ME2913

Bush



ME2613

Lateral Link

L=247

ME2613

Lateral Link

L=247

ME2913

Bush

ME2912

Bush

ME2913

Bush



ME2614

Lateral Link

L=298

ME2614

Lateral Link

L=298

ME2914

Bush

ME2912

Bush

ME2914

Bush



ME2615

Lateral Link

L=314.3

ME2615

Lateral Link

L=314.3

ME2923

Bush

ME2928

Bush

ME2938

Bush



LEFT

RIGHT

MERCEDES

W202/C208 SERIES FRONT

C/CLK CLASS

Year

1993-2001



ME2223
Center Rod
4 Cylinder



ME2224
Center Rod
6 Cylinder

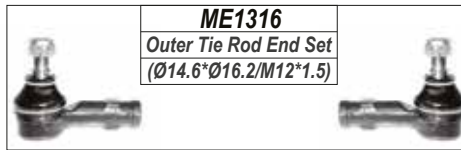

ME1316
Outer Tie Rod End Set
(Ø14.6*Ø16.2/M12*1.5)

ME1014
Outer Tie Rod End
(Ø14.6*Ø16.2/M12*1.5)



ME1014
Outer Tie Rod End
(Ø14.6*Ø16.2/M12*1.5)



ME1519
Link Stabilizer
L=276



ME1714
Upper Control Arm

ME1810
Upper Control Arm Bush

ME1715
Upper Control Arm

ME1910
Lower Ball Joint
(Ø16)



ME2024
Lower Control Arm

ME2714
Repair Kit



ME2025
Lower Control Arm

ME1910
Lower Ball Joint
(Ø16)



ME2115
Lower Control Arm Bush

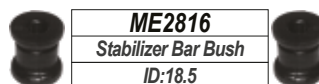

ME2816
Stabilizer Bar Bush
ID:18.5

LEFT

RIGHT

MERCEDES

W202/C208 SERIES REAR

C/CLK CLASS

Year

1993-2001

ME2921

Bush

ME2922

Bush

ME2921

Bush



ME1518

Link Stabilizer
L=200

ME1518

Link Stabilizer
L=200

ME2910

Bush



ME2610

Lateral Link
L=245

ME2610

Lateral Link
L=245

ME2913

Bush

ME2912

Bush

ME2913

Bush



ME2613

Lateral Link
L=247

ME2613

Lateral Link
L=247

ME2913

Bush

ME2912

Bush

ME2913

Bush



ME2614

Lateral Link
L=298

ME2614

Lateral Link
L=298

ME2914

Bush

ME2912

Bush

ME2914

Bush



ME2615

Lateral Link
L=314.3

ME2615

Lateral Link
L=314.3

ME2923

Bush

ME2928

Bush



LEFT

RIGHT

MERCEDES

W203 SERIES

FRONT

C CLASS

Year

2000-2007

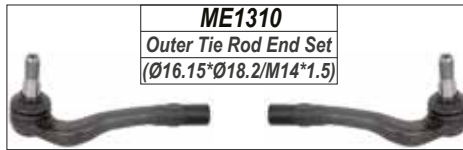

ME1310
Outer Tie Rod End Set
(Ø16.15*Ø18.2/M14*1.5)

ME1015
Outer Tie Rod End
(Ø16.15*Ø18.2/M14*1.5)



ME1423
Rack End
(16*1.5/14*1.5/244)



ME1016
Outer Tie Rod End
(Ø16.15*Ø18.2/M14*1.5)



ME1519
Link Stabilizer
L=276



ME1510
Link Stabilizer
L=277



ME1545
Link Stabilizer
L=290



ME2111
Lower Control Arm Bush



ME2012
Upper Control Arm



ME2013
Upper Control Arm



ME2110
Lower Control Arm Bush



ME2010
Lower Control Arm



ME2011
Lower Control Arm



ME2044
Lower Control Arm



ME2045
Lower Control Arm



ME2832
Shock Mounting



ME2832
Shock Mounting



LEFT

RIGHT

MERCEDES

W203 SERIES

REAR

C CLASS

Year

2000-2007

ME2910

Bush



ME1546

Link Stabilizer

L=257

ME1546

Link Stabilizer

L=257

ME2911

Bush



ME2611

Lateral Link

L=182.5

ME2612

Lateral Link

L=182.5

ME2921

Bush

ME2922

Bush

ME2921

Bush



ME1518

Link Stabilizer

L=200

ME1518

Link Stabilizer

L=200

ME2910

Bush



ME2610

Lateral Link

L=245

ME2610

Lateral Link

L=245

ME2913

Bush

ME2912

Bush

ME2913

Bush



ME2613

Lateral Link

L=247

ME2613

Lateral Link

L=247

ME2913

Bush

ME2912

Bush

ME2913

Bush



ME2614

Lateral Link

L=298

ME2614

Lateral Link

L=298

ME2914

Bush

ME2912

Bush

ME2914

Bush



ME2615

Lateral Link

L=314.3

ME2615

Lateral Link

L=314.3

ME2712

Repair Kit



LEFT

RIGHT

MERCEDES

W204 SERIES

FRONT

C CLASS

Year

2007-2014

ME1017
Outer Tie Rod End
(Ø16.15*Ø18.2/M14*1.5)

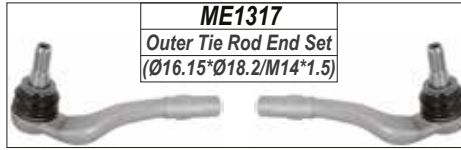

ME1317
Outer Tie Rod End Set
(Ø16.15*Ø18.2/M14*1.5)

ME1414
Rack End
(16*1.5/14*1.5/255)



ME1018
Outer Tie Rod End
(Ø16.15*Ø18.2/M14*1.5)



ME1547 / ME1548
Link Stabilizer
L=306



ME1549 / ME1550
Link Stabilizer
L=306(AI.)



ME2111
Lower Control Arm Bush



ME2012
Upper Control Arm

ME2013
Upper Control Arm

ME2116
Lower Control Arm Bush



ME2026
Lower Control Arm

ME2027
Lower Control Arm

ME2130
Lower Control Arm Bush



ME2046
Lower Control Arm
4 Matic Only

ME2047
Lower Control Arm
4 Matic Only

ME2833
Shock Mounting



ME2833
Shock Mounting



LEFT

RIGHT

MERCEDES

W204 SERIES

REAR

C CLASS

Year

2007-2014

ME2917

Bush

ME2927

Bush

ME2927

Bush

ME1551

Link Stabilizer

L=232

ME1552

Link Stabilizer

L=232

ME2939

Bush

ME2940

Bush

ME2940

Bush

ME2645

Lateral Link

ME2646

Lateral Link

ME2931

Bush

ME2941

Bush

ME2941

Bush

ME2647

Lateral Link

ME2648

Lateral Link

ME2942

Bush

ME2943

Bush

ME2943

Bush

ME2649

Lateral Link

ME2650

Lateral Link

ME2916

Bush

ME2651

Lateral Link

ME2651

Lateral Link

ME2923

Bush

ME2836

Shock Mounting

ME2836

Shock Mounting

LEFT

RIGHT

MERCEDES

W205 SERIES

FRONT

C CLASS

Year

2013-

ME1034
Outer Tie Rod End
(Ø16*Ø21.2/M14*1.5)

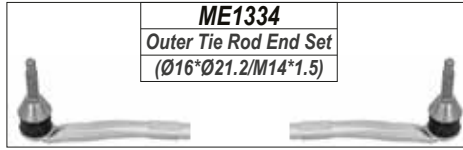

ME1334
Outer Tie Rod End Set
(Ø16*Ø21.2/M14*1.5)

ME1428
Rack End
(16*1.5/14*1.5/240)



ME1035
Outer Tie Rod End
(Ø16*Ø21.2/M14*1.5)



ME1553 / ME1554
Link Stabilizer
L=141.5



ME1816
Upper Control Arm Bush



ME1730
Upper Control Arm



ME1731
Upper Control Arm



ME2131
Lower Control Arm Bush



ME2048
Lower Control Arm



ME2049
Lower Control Arm



ME2132
Lower Control Arm Bush



ME2133
Lower Control Arm Bush



ME2132
Lower Control Arm Bush



ME2152
Lower Control Arm Bush



ME2050
Lower Control Arm



ME2051
Lower Control Arm

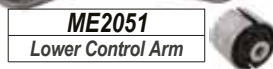

ME2152
Lower Control Arm Bush



LEFT

RIGHT

MERCEDES

W205 SERIES

REAR

C CLASS

Year

2013-

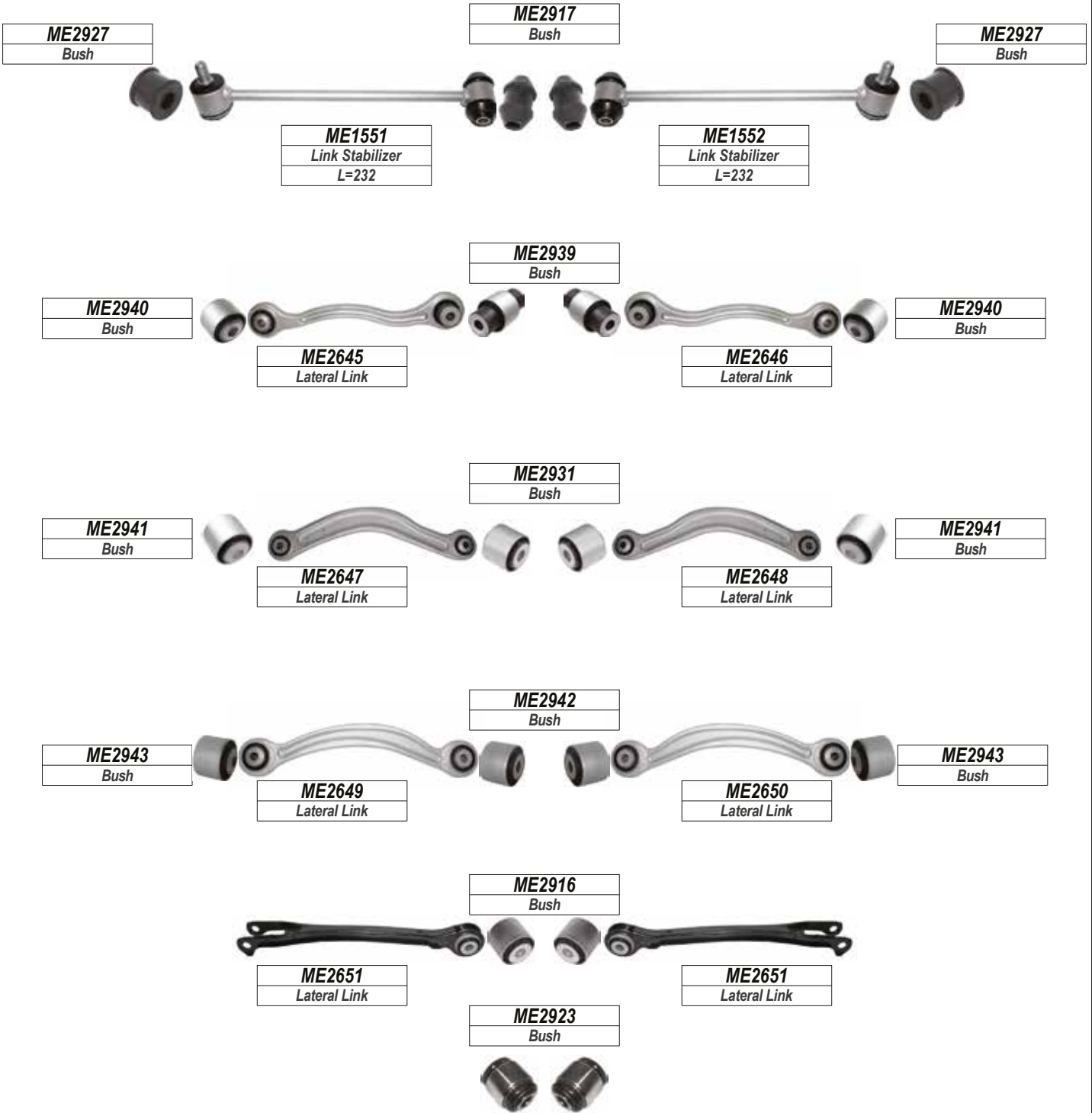

LEFT

RIGHT

MERCEDES

W210 SERIES

FRONT

E CLASS

Year

1995-2002

ME1335

Outer Tie Rod End Set
(Ø16.6*Ø18.2/M14*1.5)

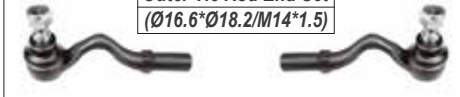

ME1036

Outer Tie Rod End
(Ø16.6*Ø18.2/M14*1.5)



ME1415

Rack End
(16*1.5/14*1.5/246)



ME1037

Outer Tie Rod End
(Ø16.6*Ø18.2/M14*1.5)



ME1555 / ME1556

Link Stabilizer
L=115



ME1810

Upper Control Arm Bush



ME1714

Upper Control Arm



ME1715

Upper Control Arm

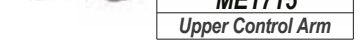

ME2134

Lower Control Arm Bush



ME2134

Lower Control Arm Bush



ME1910

Lower Ball Joint
(Ø16)



ME2721

Repair Kit



ME1910

Lower Ball Joint
(Ø16)



ME2053

Lower Control Arm



ME2135

Lower Control Arm Bush



ME2054

Lower Control Arm



ME2816

Stabilizer Bar Bush
ID:18.5



LEFT

RIGHT

MERCEDES

W210 SERIES

REAR

E CLASS

Year

1995-2002

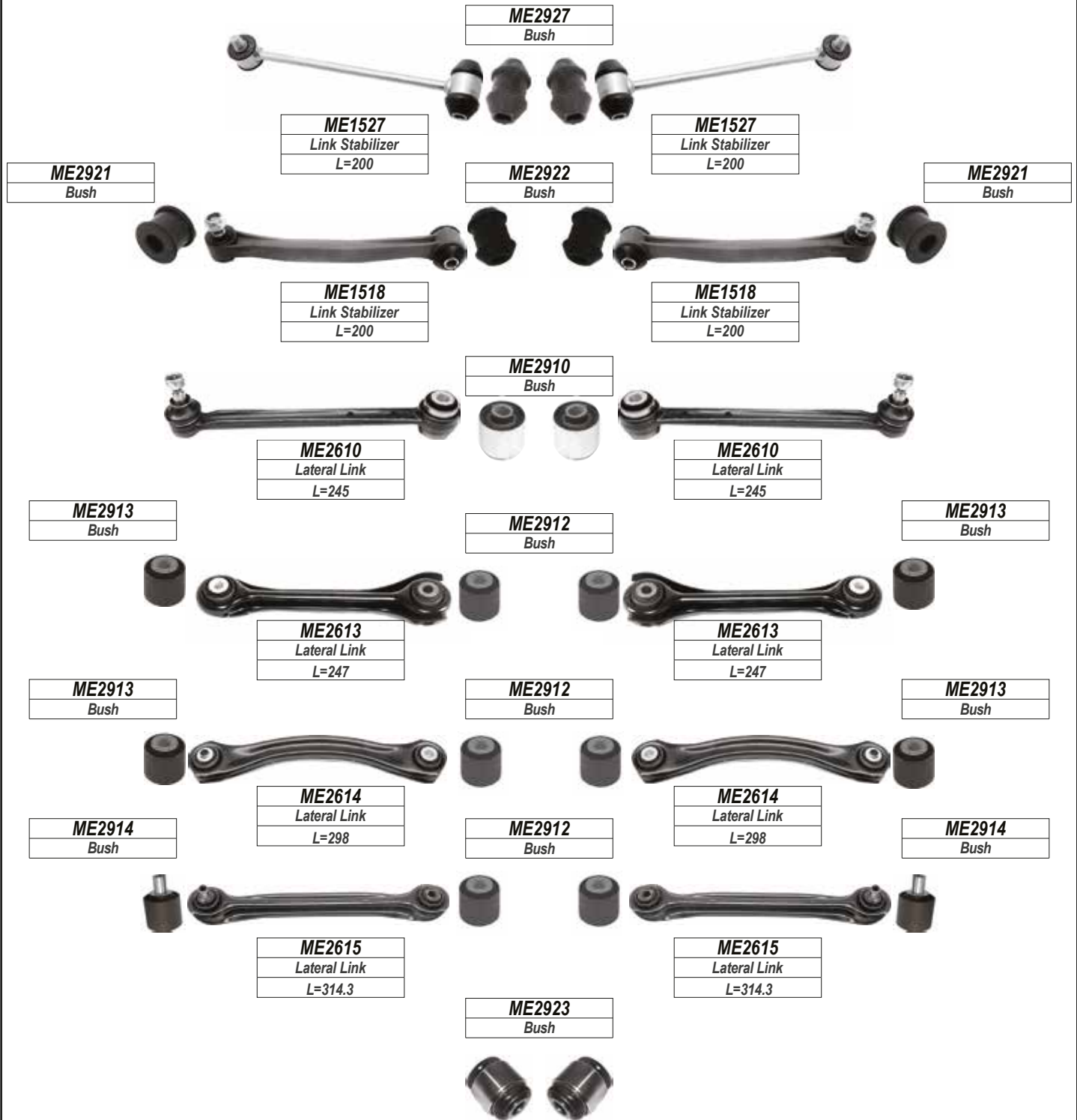

LEFT

RIGHT

MERCEDES

W211 SERIES

FRONT

E-CLASS

Year

2002-2009

ME1011
Outer Tie Rod End
(Ø16.6*Ø18.2/M14*1.5)

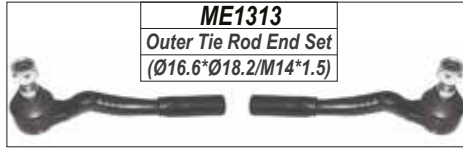

ME1012
Outer Tie Rod End
(Ø16.6*Ø18.2/M14*1.5)

ME1423
Rack End
(16*1.5/14*1.5/244)



ME1515 / ME1516
Link Stabilizer
L=128.5

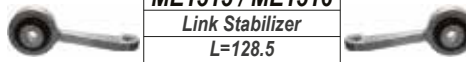

ME1610
Upper Ball Joint
(Ø13)



ME1816
Upper Control Arm Bush

ME1610
Upper Ball Joint
(Ø13)



ME1712
Upper Control Arm

ME1713
Upper Control Arm

ME1914
Lower Ball Joint
(Ø22)

ME1914
Lower Ball Joint
(Ø22)

ME1913
Lower Ball Joint
(Ø17.15)



ME2113
Lower Control Arm Bush

ME1913
Lower Ball Joint
(Ø17.15)



ME2114
Lower Control Arm Bush

ME2018
Lower Control Arm

ME2019
Lower Control Arm

ME2114
Lower Control Arm Bush

ME2112
Lower Control Arm Bush



ME2016
Lower Control Arm

ME2017
Lower Control Arm

ME2834
Shock Mounting



ME2834
Shock Mounting



LEFT

RIGHT

MERCEDES

W211 SERIES

REAR

E-CLASS

Year

2002-2009

ME2917

Bush



ME1517

Link Stabilizer
L=259.5

ME1517

Link Stabilizer
L=259.5

ME2916

Bush



ME2621

Lateral Link

ME2621

Lateral Link

ME2920

Bush



ME2624

Lateral Link

ME2625

Lateral Link

ME2919

Bush



ME2918

Bush

ME2918

Bush

ME2622

Lateral Link

ME2623

Lateral Link



ME2619

Lateral Link



ME2620

Lateral Link

LEFT

RIGHT

MERCEDES

W212 SERIES

FRONT

E-CLASS

Year

2009-

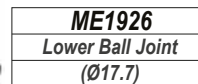
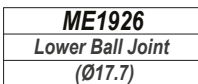
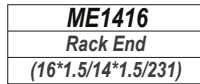
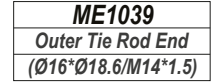
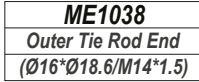
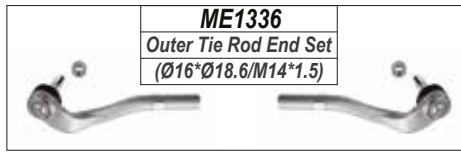

LEFT

RIGHT

MERCEDES

W212 SERIES

REAR

E-CLASS

Year

2009-

ME2927
Bush

ME2917
Bush

ME2927
Bush



ME1551
Link Stabilizer
L=232

ME1552
Link Stabilizer
L=232

ME2940
Bush

ME2939
Bush

ME2940
Bush



ME2645
Lateral Link

ME2646
Lateral Link

ME2941
Bush

ME2931
Bush

ME2941
Bush



ME2647
Lateral Link

ME2648
Lateral Link

ME2943
Bush

ME2942
Bush

ME2943
Bush



ME2649
Lateral Link

ME2650
Lateral Link

ME2916
Bush

ME2651
Lateral Link

ME2651
Lateral Link



ME2923
Bush



ME2836
Shock Mounting

ME2836
Shock Mounting



LEFT

RIGHT

MERCEDES

W220 SERIES

FRONT

S-CLASS

Year

1999-2005

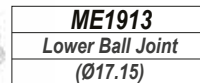
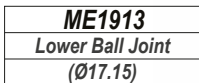
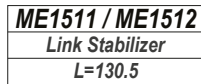
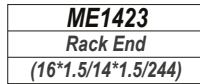
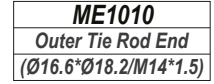
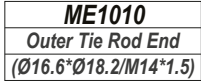
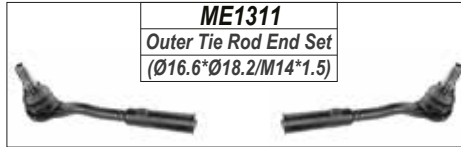

LEFT

RIGHT

MERCEDES

W220 SERIES

REAR

S-CLASS

Year

1999-2005

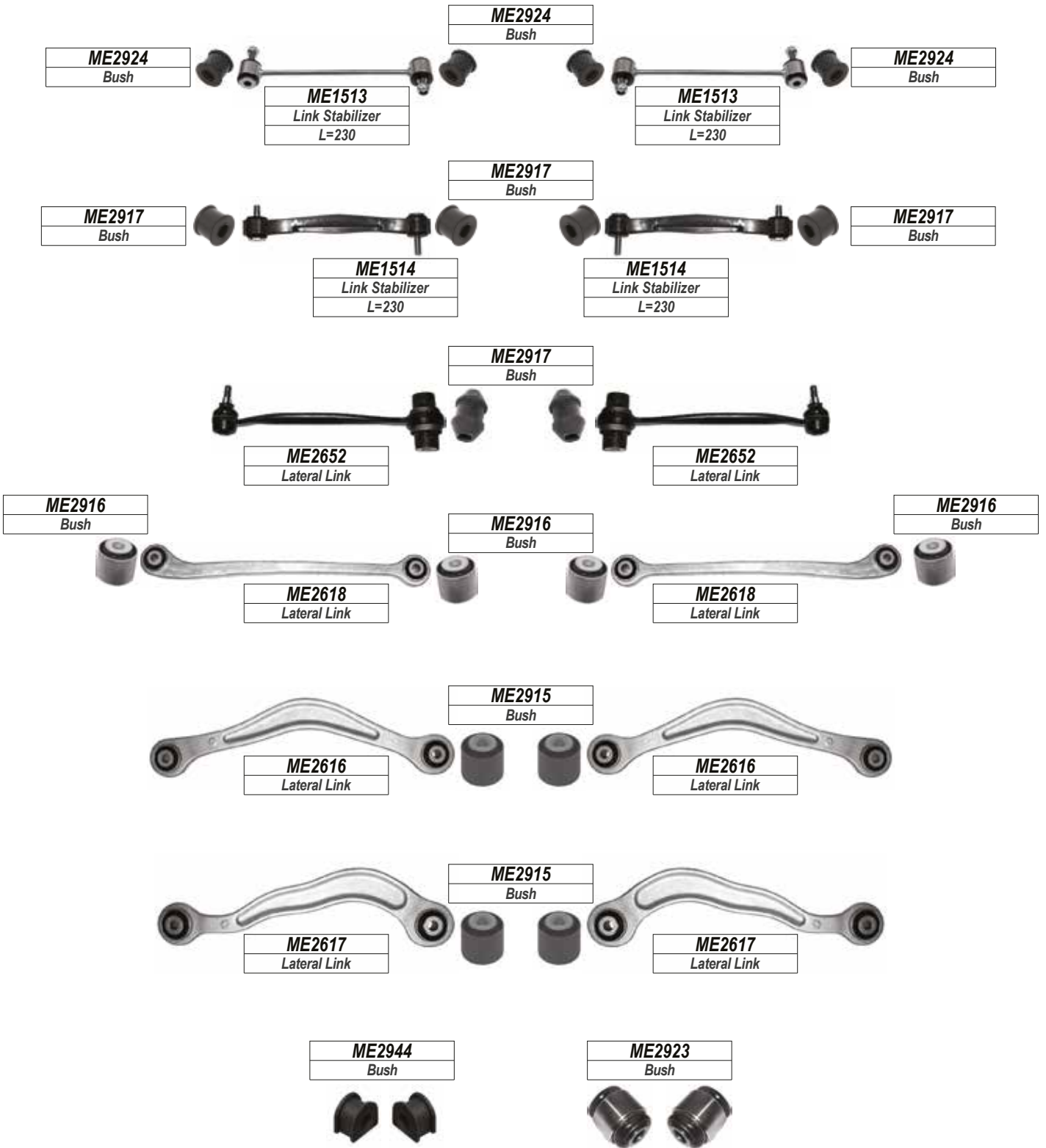

LEFT

RIGHT

MERCEDES

W221 SERIES

FRONT

S-CLASS

Year

2006-2013

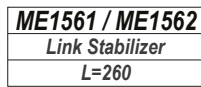
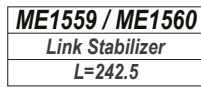
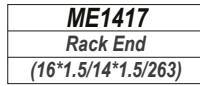
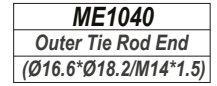
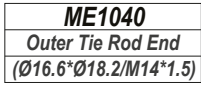
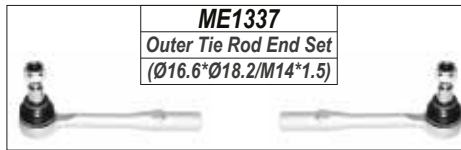

LEFT

RIGHT

MERCEDES

W221 SERIES

REAR

S-CLASS

Year

2006-2013

ME1563 / ME1564
Link Stabilizer
L=117



ME1535
Link Stabilizer
L=117



ME2945
Bush

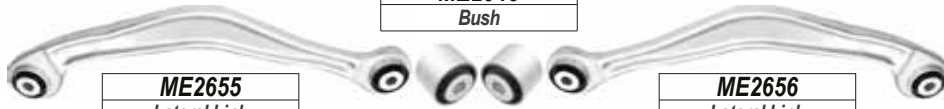

ME2655
Lateral Link

ME2656
Lateral Link

ME2931
Bush

ME2941
Bush



ME2941
Bush

ME2653
Lateral Link

ME2654
Lateral Link

ME2931
Bush

ME2941
Bush



ME2941
Bush

ME2657
Lateral Link

ME2658
Lateral Link

ME2946
Bush

ME2947
Bush



ME2947
Bush

ME2659
Lateral Link

ME2660
Lateral Link

ME2923
Bush



LEFT

RIGHT

MERCEDES

W245 SERIES

FRONT

B CLASS

Year

2006-2012

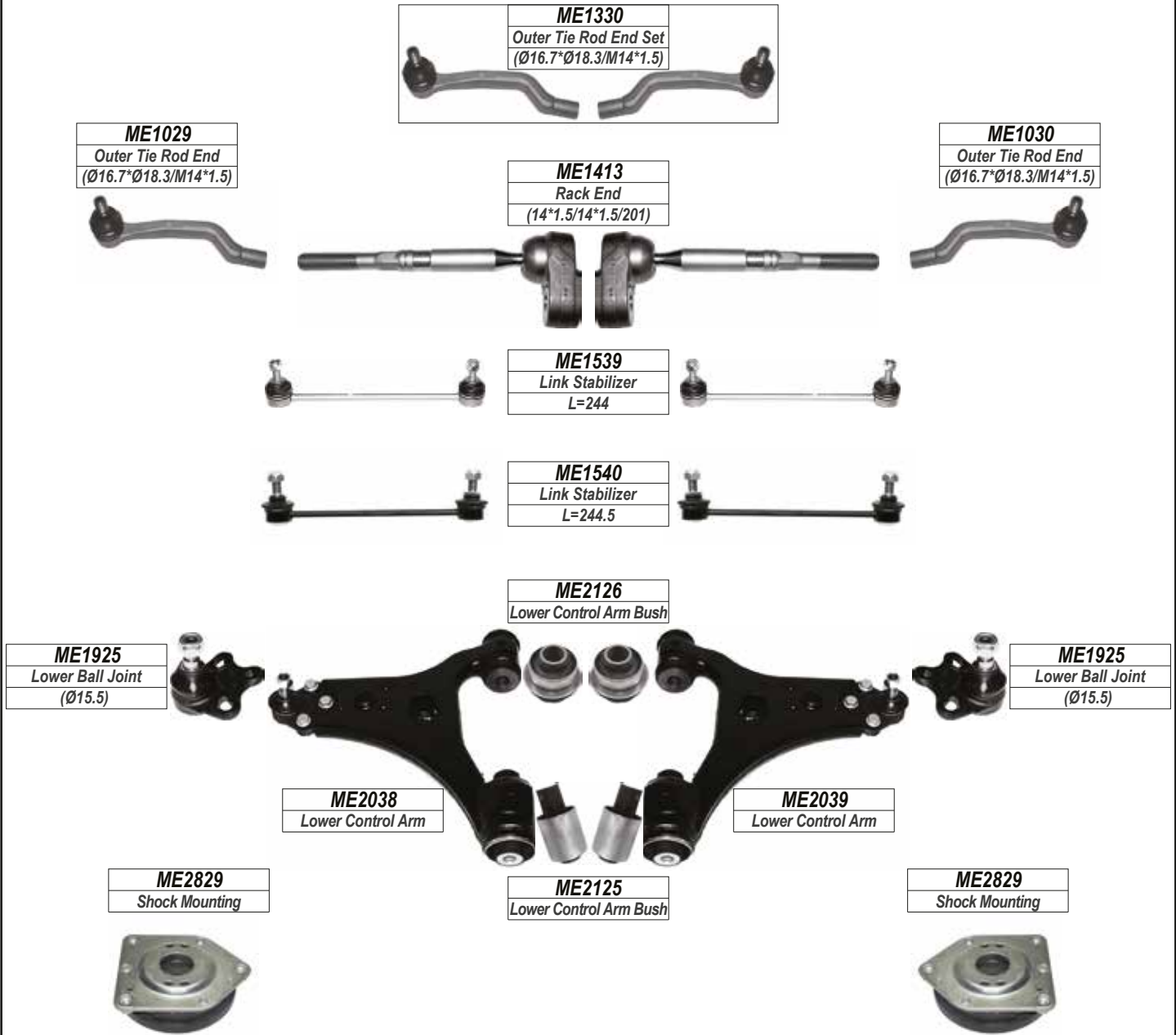

W245 SERIES

REAR



LEFT

RIGHT

MERCEDES

W246 SERIES

FRONT

B CLASS

Year

2012-

ME1031
Outer Tie Rod End
(Ø16.3*Ø20.2/M14*1.5)



ME1331
Outer Tie Rod End Set
(Ø16.3*Ø20.2/M14*1.5)

ME1427
Rack End
(14*1.5/14*1.5/222)



ME1032
Outer Tie Rod End
(Ø16.3*Ø20.2/M14*1.5)



ME1542
Link Stabilizer
L=333



ME2129
Lower Control Arm Bush



ME2040
Lower Control Arm



ME2041
Lower Control Arm



ME2830
Shock Mounting
W/Out Sports Package



ME2127 / ME2128
Lower Control Arm Bush



ME2830
Shock Mounting
W/Out Sports Package



ME2831
Shock Mounting
With Sports Package



ME2831
Shock Mounting
With Sports Package



W246 SERIES

REAR

ME2936
Bush



ME1543
Link Stabilizer
L=79

ME1543
Link Stabilizer
L=79

LEFT

RIGHT

MERCEDES

W251 SERIES

FRONT

R-CLASS

Year

2006-2013

ME1041
Outer Tie Rod End
(Ø15*Ø18.9/M14*1.5)

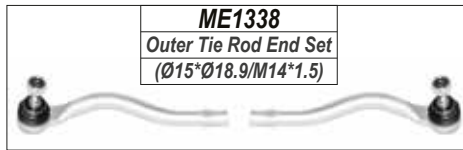

ME1338
Outer Tie Rod End Set
(Ø15*Ø18.9/M14*1.5)

ME1411
Rack End
(16*1.5/14*1.5/202)



ME1042
Outer Tie Rod End
(Ø15*Ø18.9/M14*1.5)



ME1565
Link Stabilizer
L=205

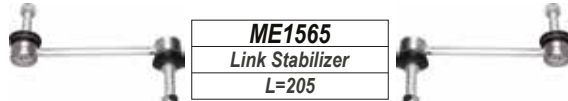

ME1814
Upper Control Arm Bush



ME1726
Upper Control Arm

ME2121
Lower Control Arm Bush



ME2122
Lower Control Arm Bush



ME1727
Upper Control Arm

ME2121
Lower Control Arm Bush



ME1921
Lower Ball Joint
(Ø19.3)



ME1921
Lower Ball Joint
(Ø19.3)



ME2065
Lower Control Arm



ME2066
Lower Control Arm



ME2141 / ME2150
Lower Control Arm Bush



W251 SERIES

REAR

ME1922
Lower Ball Joint
(Ø19.3)



ME1535
Link Stabilizer
L=117

ME1922
Lower Ball Joint
(Ø19.3)



ME2934
Bush



ME2931
Bush



ME2934
Bush

ME2639
Lateral Link



ME2640
Lateral Link



MERCEDES

W638 SERIES

FRONT

Year

VITO

1996-2004

ME1043
Outer Tie Rod End
(Ø16.97*Ø20.2/M16*1.5)



ME1339
Outer Tie Rod End Set
(Ø16.97*Ø20.2/M16*1.5)

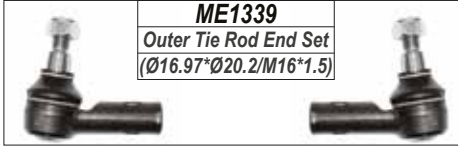

ME1043
Outer Tie Rod End
(Ø16.97*Ø20.2/M16*1.5)



ME1418
Rack End
(16*1.5/16*1.5/336)



ME1566 / ME1567
Link Stabilizer
L=250



ME1568 / ME1569
Link Stabilizer
L=230



ME2142
Lower Control Arm Bush

ME1927
Lower Ball Joint
(Ø19.3)



ME1927
Lower Ball Joint
(Ø19.3)



ME2067
Lower Control Arm

ME2068
Lower Control Arm

ME2143
Lower Control Arm Bush

ME2820
Stabilizer Bar Bush
ID:13.5



ME2821
Stabilizer Bar Bush
ID:24



W638 SERIES

REAR

ME1570
Link Stabilizer
L=105



LEFT

RIGHT

MERCEDES

W639 SERIES

FRONT

VITO. VIANO

Year

2004-2010

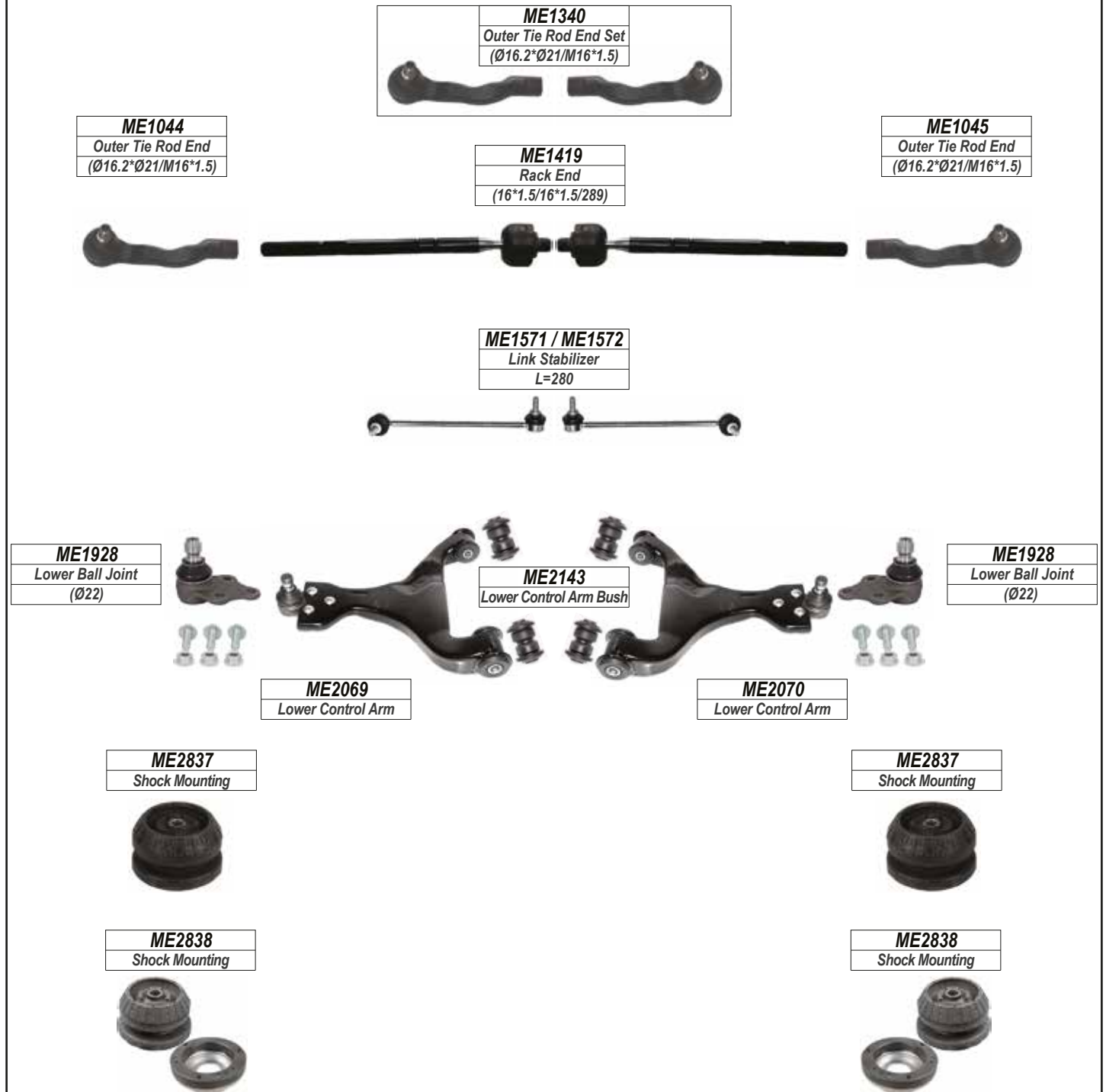

W639 SERIES

REAR

ME2661
Lateral Link



LEFT

RIGHT

MERCEDES

W639 SERIES

FRONT

VITO. VIANO

Year

2011-2015

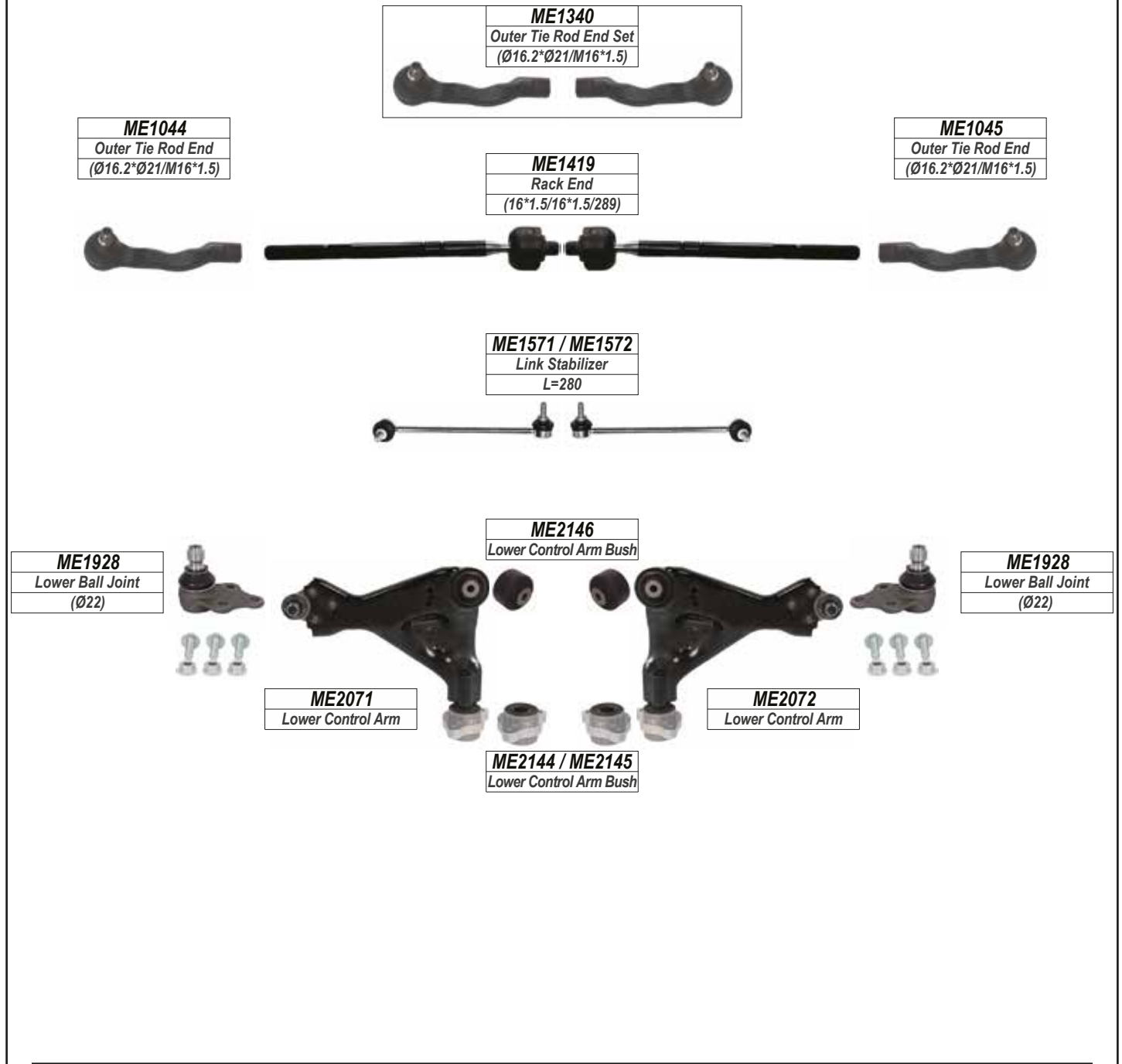

W639 SERIES

REAR

ME2661
Lateral Link



LEFT

RIGHT

MERCEDES

W447 SERIES

FRONT

VITO. V200. V220. V250

Year

2015-

ME1046
Outer Tie Rod End
(Ø16.7*Ø21/M16*1.5)



ME1048
Outer Tie Rod End
(Ø14.7*Ø19.1/M16*1.5)

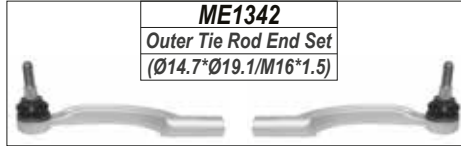

ME1047
Outer Tie Rod End
(Ø16.7*Ø21/M16*1.5)



ME1420
Rack End
(16*1.5/16*1.5/264)



ME1049
Outer Tie Rod End
(Ø14.7*Ø19.1/M16*1.5)



ME1573 / ME1574
Link Stabilizer
L=362



ME1575 / ME1576
Link Stabilizer
L=362



ME2073
Lower Control Arm

ME2074
Lower Control Arm

ME1929
Lower Ball Joint
(Ø16)



ME1929
Lower Ball Joint
(Ø16)



ME2075
Lower Control Arm

ME2076
Lower Control Arm

LEFT

RIGHT

MERCEDES

W903 SERIES

FRONT

SPRINTER

Year

1995-2006

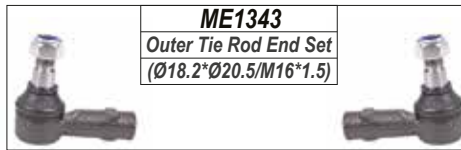

ME1343
Outer Tie Rod End Set
(Ø18.2*Ø20.5/M16*1.5)

ME1050
Outer Tie Rod End
(Ø18.2*Ø20.5/M16*1.5)

ME1050
Outer Tie Rod End
(Ø18.2*Ø20.5/M16*1.5)

ME1421
Rack End
(16*1.5/16*1.5/385)

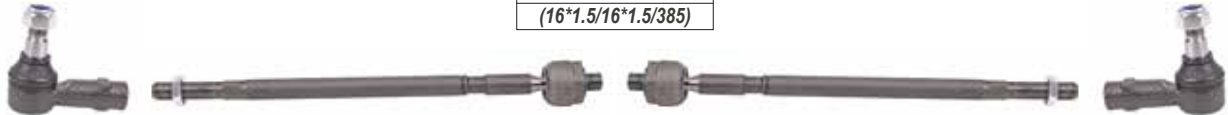

ME1577 / ME1578
Link Stabilizer
L=128.5

ME1579 / ME1580
Link Stabilizer
L=115

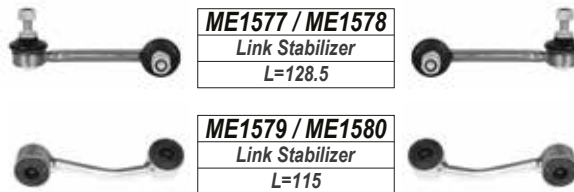

ME2147
Lower Control Arm Bush

ME2077
Lower Control Arm

ME2078
Lower Control Arm

ME1930
Lower Ball Joint
(Ø23.5)

ME1930
Lower Ball Joint
(Ø23.5)



ME2810
Stabilizer Bar Bush
ID:13.5 OD:26 W:20

ME2811
Stabilizer Bar Bush
ID:22 W:31

ME2812
Stabilizer Bar Bush
ID:33 W:50.5

ME2813
Stabilizer Bar Bush
ID:27 W:54

ME2814
Stabilizer Bar Bush
ID:27 W:38



ME2815
Shock Mounting

ME2815
Shock Mounting

ME2826
Shock Mounting

ME2826
Shock Mounting



LEFT

RIGHT

MERCEDES

W903 SERIES

REAR

SPRINTER

Year

1995-2006

ME2951

Bush



ME1581

Link Stabilizer

L=94.5

ME1581

Link Stabilizer

L=94.5

ME2951

Bush



ME1582

Link Stabilizer

L=245.5

ME1582

Link Stabilizer

L=245.5

ME2951

Bush



ME1583

Link Stabilizer

L=302

ME1583

Link Stabilizer

L=302

ME2952

Stabilizer Bar Bush

ID:23 OD:35



ME2953

Stabilizer Bar Bush

ID:12.3 OD:38.7



ME2954

Stabilizer Bar Bush

ID:12.2 OD:38 W:134



ME2959

Stabilizer Bar Bush

ID:18 OD:32 W:31



LEFT

RIGHT

MERCEDES

W906 SERIES

FRONT

SPRINTER

Year

2006-

ME1051
Outer Tie Rod End
(Ø16.85*Ø21/M16*1.5)

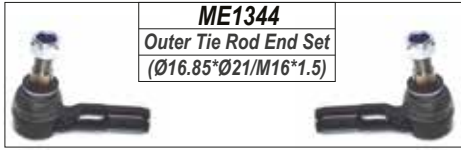

ME1344
Outer Tie Rod End Set
(Ø16.85*Ø21/M16*1.5)

ME1422
Rack End
(18*1.5/16*1.5/401)

ME1051
Outer Tie Rod End
(Ø16.85*Ø21/M16*1.5)

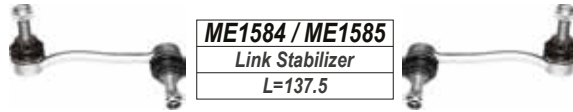

ME1584 / ME1585
Link Stabilizer
L=137.5

ME2148
Lower Control Arm Bush



ME1931
Lower Ball Joint
(Ø21.8)



ME1931
Lower Ball Joint
(Ø21.8)



ME2079
Lower Control Arm

ME2080
Lower Control Arm

ME2149
Lower Control Arm Bush

ME2822
Stabilizer Bar Bush
ID:24 W:45



ME2823
Stabilizer Bar Bush
ID:20 W:45



ME2959
Stabilizer Bar Bush
ID:20 W:52.5



ME2960
Stabilizer Bar Bush
ID:15.5 W:52.5



ME2825
Shock Mounting



ME2825
Shock Mounting



W906 SERIES

REAR

ME2955
Bush



ME1586
Link Stabilizer
L=212

ME1586
Link Stabilizer
L=212



ME2824
Stabilizer Bar Bush

LEFT

RIGHT

MINI

COOPER- S.S-ONE FRONT

R50.R52.R53

Year

2001-2007

	<table border="1"> <tr><td>MN1310</td></tr> <tr><td>Outer Tie Rod End Set (Ø12.8*Ø15.3/M14*1.5)</td></tr> </table>	MN1310	Outer Tie Rod End Set (Ø12.8*Ø15.3/M14*1.5)							
MN1310										
Outer Tie Rod End Set (Ø12.8*Ø15.3/M14*1.5)										
	<table border="1"> <tr><td>MN1311</td></tr> <tr><td>Outer Tie Rod End Set (Ø12.8*Ø15.3/M14*1.5)</td></tr> </table>	MN1311	Outer Tie Rod End Set (Ø12.8*Ø15.3/M14*1.5)							
MN1311										
Outer Tie Rod End Set (Ø12.8*Ø15.3/M14*1.5)										
<table border="1"> <tr><td>MN1010</td></tr> <tr><td>Outer Tie Rod End (Ø12.8*Ø15.3/M14*1.5)</td></tr> </table>	MN1010	Outer Tie Rod End (Ø12.8*Ø15.3/M14*1.5)		<table border="1"> <tr><td>MN1011</td></tr> <tr><td>Outer Tie Rod End (Ø12.8*Ø15.3/M14*1.5)</td></tr> </table>	MN1011	Outer Tie Rod End (Ø12.8*Ø15.3/M14*1.5)				
MN1010										
Outer Tie Rod End (Ø12.8*Ø15.3/M14*1.5)										
MN1011										
Outer Tie Rod End (Ø12.8*Ø15.3/M14*1.5)										
<table border="1"> <tr><td>MN1012</td></tr> <tr><td>Outer Tie Rod End (Ø12.8*Ø15.3/M14*1.5)</td></tr> <tr><td>04-07 convertible</td></tr> </table>	MN1012	Outer Tie Rod End (Ø12.8*Ø15.3/M14*1.5)	04-07 convertible	<table border="1"> <tr><td>MN1410</td></tr> <tr><td>Rack End (16*1.5/14*1.5/184)</td></tr> </table>	MN1410	Rack End (16*1.5/14*1.5/184)	<table border="1"> <tr><td>MN1013</td></tr> <tr><td>Outer Tie Rod End (Ø12.8*Ø15.3/M14*1.5)</td></tr> <tr><td>04-07 convertible</td></tr> </table>	MN1013	Outer Tie Rod End (Ø12.8*Ø15.3/M14*1.5)	04-07 convertible
MN1012										
Outer Tie Rod End (Ø12.8*Ø15.3/M14*1.5)										
04-07 convertible										
MN1410										
Rack End (16*1.5/14*1.5/184)										
MN1013										
Outer Tie Rod End (Ø12.8*Ø15.3/M14*1.5)										
04-07 convertible										
	<table border="1"> <tr><td>MN1510</td></tr> <tr><td>Link Stabilizer L=300</td></tr> </table>	MN1510	Link Stabilizer L=300							
MN1510										
Link Stabilizer L=300										
<table border="1"> <tr><td>MN1610</td></tr> <tr><td>Upper Ball Joint (Ø16.5)</td></tr> </table>	MN1610	Upper Ball Joint (Ø16.5)	<table border="1"> <tr><td>MN1549</td></tr> <tr><td>Link Stabilizer L=331</td></tr> </table>	MN1549	Link Stabilizer L=331	<table border="1"> <tr><td>MN1611</td></tr> <tr><td>Upper Ball Joint (Ø16.5)</td></tr> </table>	MN1611	Upper Ball Joint (Ø16.5)		
MN1610										
Upper Ball Joint (Ø16.5)										
MN1549										
Link Stabilizer L=331										
MN1611										
Upper Ball Joint (Ø16.5)										
	<table border="1"> <tr><td>MN2112</td></tr> <tr><td>Lower Control Arm Bush</td></tr> </table>	MN2112	Lower Control Arm Bush							
MN2112										
Lower Control Arm Bush										
<table border="1"> <tr><td>MN1910</td></tr> <tr><td>Lower Ball Joint (Ø15)</td></tr> </table>	MN1910	Lower Ball Joint (Ø15)	<table border="1"> <tr><td>MN2010</td></tr> <tr><td>Lower Control Arm</td></tr> </table>	MN2010	Lower Control Arm	<table border="1"> <tr><td>MN2011</td></tr> <tr><td>Lower Control Arm</td></tr> </table>	MN2011	Lower Control Arm		
MN1910										
Lower Ball Joint (Ø15)										
MN2010										
Lower Control Arm										
MN2011										
Lower Control Arm										
<table border="1"> <tr><td>MN2810</td></tr> <tr><td>Shock Mounting</td></tr> </table>	MN2810	Shock Mounting	<table border="1"> <tr><td>MN2110 / MN2111</td></tr> <tr><td>Lower Control Arm Bush</td></tr> </table>	MN2110 / MN2111	Lower Control Arm Bush	<table border="1"> <tr><td>MN2810</td></tr> <tr><td>Shock Mounting</td></tr> </table>	MN2810	Shock Mounting		
MN2810										
Shock Mounting										
MN2110 / MN2111										
Lower Control Arm Bush										
MN2810										
Shock Mounting										

COOPER- S.S-ONE REAR

	<table border="1"> <tr><td>MN2910</td></tr> <tr><td>Bush</td></tr> </table>	MN2910	Bush					
MN2910								
Bush								
<table border="1"> <tr><td>MN2910</td></tr> <tr><td>Bush</td></tr> </table>	MN2910	Bush	<table border="1"> <tr><td>MN2610</td></tr> <tr><td>Lateral Link</td></tr> </table>	MN2610	Lateral Link	<table border="1"> <tr><td>MN2610</td></tr> <tr><td>Lateral Link</td></tr> </table>	MN2610	Lateral Link
MN2910								
Bush								
MN2610								
Lateral Link								
MN2610								
Lateral Link								
	<table border="1"> <tr><td>MN1511</td></tr> <tr><td>Link Stabilizer L=233</td></tr> </table>	MN1511	Link Stabilizer L=233					
MN1511								
Link Stabilizer L=233								

LEFT

RIGHT

MINI

**COOPER.S.ONE FRONT
CLUBMAN.JOHN COOPER**

F55. F56. F57

Year

2007-

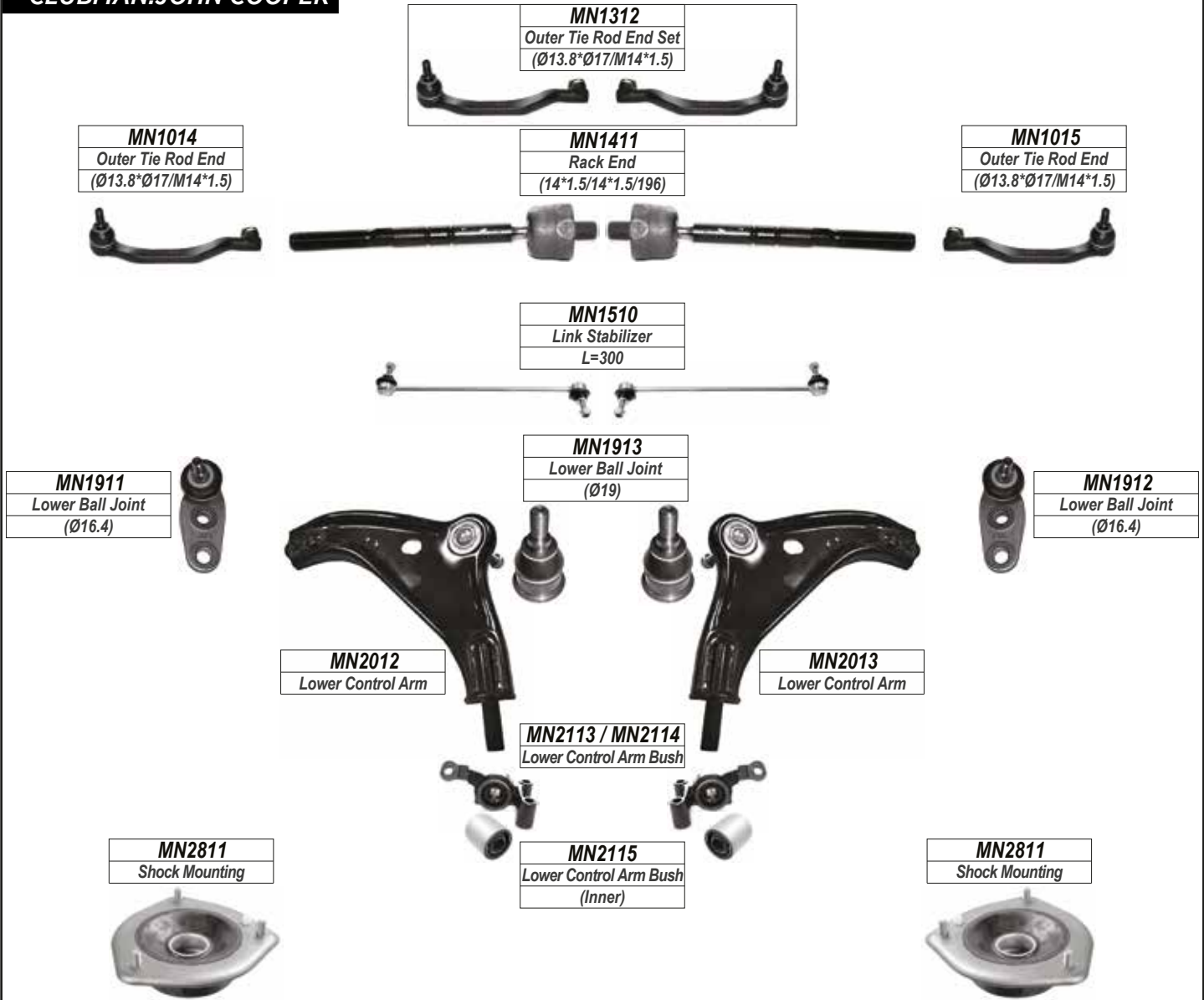

**COOPER.S.ONE REAR
CLUBMAN.JOHN COOPER**



LEFT

RIGHT

MINI

**COOPER.S.ONE FRONT
CLUBMAN.JOHN COOPER**

F55. F56. F57

Year

2014-

MN1016
Outer Tie Rod End
(Ø16.2*Ø27/M14*1.5)



MN1313
Outer Tie Rod End Set
(Ø16.2*Ø27/M14*1.5)

MN1412
Rack End
(14*1.5/14*1.5/190)



MN1017
Outer Tie Rod End
(Ø16.2*Ø27/M14*1.5)



BM1519
Link Stabilizer
L=320



BM2140
Lower Control Arm Bush



MN2016
Lower Control Arm

MN2017
Lower Control Arm

BM2112 / BM2113
Lower Control Arm Bush



LEFT

RIGHT

MINI

COUNTRYMAN. FRONT
PACEMAN

R60. R61

Year

2010-

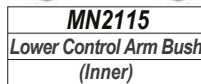
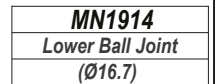
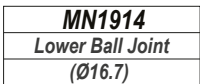
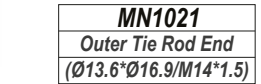
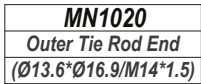
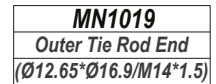
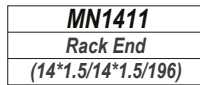
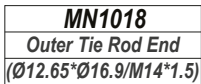

COUNTRYMAN(R60) REAR
PACEMAN(R61)



LEFT

RIGHT

mitsubishi

ASX

FRONT

ALL MODEL

Year

2011-

CI1029
Outer Tie Rod End
(Ø13.45*Ø15.1/M14*1.5)

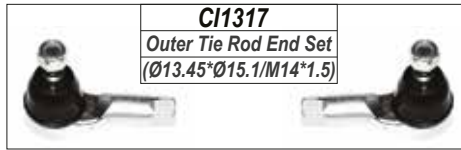

CI1317
Outer Tie Rod End Set
(Ø13.45*Ø15.1/M14*1.5)

CI1029
Outer Tie Rod End
(Ø13.45*Ø15.1/M14*1.5)



CI1420
Rack End
(14*1.5/14*1.5/341)



CI1516
Link Stabilizer
L=265



CI2121
Lower Control Arm Bush



CI1910
Lower Ball Joint
(Ø20)



CI1910
Lower Ball Joint
(Ø20)



CI2020
Lower Control Arm



CI2021
Lower Control Arm



CI2120
Lower Control Arm Bush

MI2810
Shock Mounting



MI2810
Shock Mounting



LEFT

RIGHT

MITSUBISHI

COLT

FRONT

2WD

Year

1994-1998

MI1310
Outer Tie Rod End Set
(Ø12.5*Ø13.5/M14*1.5)



MI1311
Inner Tie Rod End Set
(Ø12.18*Ø14/M14*1.5)



MI1011
Outer Tie Rod End
(Ø12.5*Ø13.5/M14*1.5)



MI1111 / MI1112
Inner Tie Rod End
(Ø12.18*Ø14/M14*1.5)



MI1011
Outer Tie Rod End
(Ø12.5*Ø13.5/M14*1.5)



MI1610
Upper Ball Joint
(Ø16)



MI1810
Upper Control Arm Bush

MI1710
Upper Control Arm

MI1711
Upper Control Arm

MI1610
Upper Ball Joint
(Ø16)



HY1922
Lower Ball Joint
(Ø19.5)



MI2110
Lower Control Arm Bush



MI2010
Lower Control Arm

MI2011
Lower Control Arm

HY1922
Lower Ball Joint
(Ø19.5)



MI2511
Pitman Arm



MI2411
Idler Arm



LEFT

RIGHT

MITSUBISHI

COLT

FRONT

4WD

Year

1994-1998

MI2210

Center Rod



MI1312

Outer Tie Rod End Set
(Ø13.6*Ø15.8/M16*1.5)

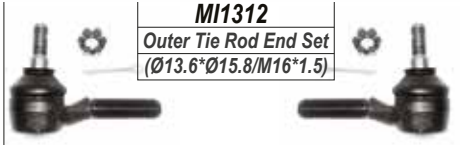

MI1313

Inner Tie Rod End Set
(Ø13.7*Ø16.2/M16*1.5)



MI1012

Outer Tie Rod End
(Ø13.6*Ø15.8/M16*1.5)



MI1113

Inner Tie Rod End
(Ø13.7*Ø16.2/M16*1.5)



MI1012

Outer Tie Rod End
(Ø13.6*Ø15.8/M16*1.5)



MI1610

Upper Ball Joint
(Ø16)



MI1712

Upper Control Arm



MI1713

Upper Control Arm

MI1610

Upper Ball Joint
(Ø16)



MI1910

Lower Ball Joint
(Ø19.5)



MI2028

Lower Control Arm

MI2111

Lower Control Arm Bush



MI2029

Lower Control Arm

MI1910

Lower Ball Joint
(Ø19.5)



MI2512

Pitman Arm



MI2412

Idler Arm



LEFT

RIGHT

MITSUBISHI

COLT

FRONT

4WD

Year

1998-2009

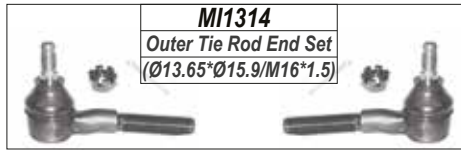

MI1010
Outer Tie Rod End
(Ø13.65*Ø15.9/M16*1.5)



MI1110
Inner Tie Rod End
(Ø13.6*Ø15.85/M16*1.5)



MI1010
Outer Tie Rod End
(Ø13.65*Ø15.9/M16*1.5)



MI1611
Upper Ball Joint
(Ø16)



MI1714
Upper Control Arm



MI1715
Upper Control Arm



MI1611
Upper Ball Joint
(Ø16)

MI1612
Upper Ball Joint
(Ø16)



MI1612
Upper Ball Joint
(Ø16)

MI1911
Lower Ball Joint
(Ø19.5)



MI2014
Lower Control Arm

MI2015
Lower Control Arm



MI1912
Lower Ball Joint
(Ø19.5)

MI2111
Lower Control Arm Bush



MI2510
Pitman Arm



MI2410
Idler Arm



LEFT

RIGHT

MITSUBISHI

COLT

FRONT

LDW STANDARD BODY

Year

1998-2009

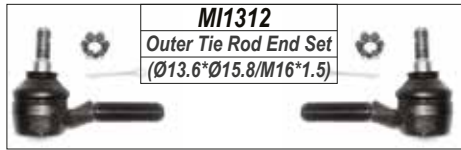

MI1312
Outer Tie Rod End Set
(Ø13.6*Ø15.8/M16*1.5)



MI1316
Inner Tie Rod End Set
(Ø13.7*Ø16.2/M16*1.5)

MI1012
Outer Tie Rod End
(Ø13.6*Ø15.8/M16*1.5)



MI1114
Inner Tie Rod End
(Ø13.7*Ø16.2/M16*1.5)



MI1012
Outer Tie Rod End
(Ø13.6*Ø15.8/M16*1.5)



MI1610
Upper Ball Joint
(Ø16)



MI1716
Upper Control Arm

MI1717
Upper Control Arm

MI1610
Upper Ball Joint
(Ø16)



HY1922
Lower Ball Joint
(Ø19.67)



MI2114
Lower Control Arm Bush



MI2016
Lower Control Arm

MI2017
Lower Control Arm

HY1922
Lower Ball Joint
(Ø19.67)



MI2413
Pitman Arm



MI2513
Idler Arm



LEFT

RIGHT

MITSUBISHI

COLT

FRONT

LDV HI-LINE RAISED BODY 4X4

Year

1998-2009

MI1314

Outer Tie Rod End Set
(Ø13.65*Ø15.9/M16*1.5)

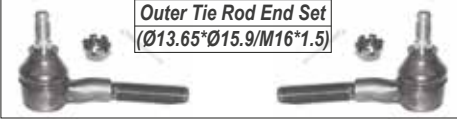

MI1315

Inner Tie Rod End Set
(Ø13.6*Ø15.85/M16*1.5)

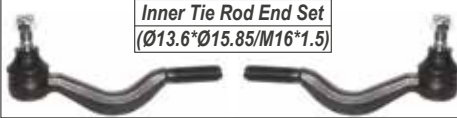

MI1010

Outer Tie Rod End
(Ø13.65*Ø15.9/M16*1.5)



MI1110

Inner Tie Rod End
(Ø13.6*Ø15.85/M16*1.5)



MI1010

Outer Tie Rod End
(Ø13.65*Ø15.9/M16*1.5)



MI1610

Upper Ball Joint
(Ø16)



MI1610

Upper Ball Joint
(Ø16)



MI1716

Upper Control Arm

MI1717

Upper Control Arm

MI1911

Lower Ball Joint
(Ø19.45)



MI1912

Lower Ball Joint
(Ø19.45)



MI2014

Lower Control Arm

MI2015

Lower Control Arm

MI2111

Lower Control Arm Bush



MI2510

Pitman Arm



MI2410

Idler Arm



LEFT

RIGHT

MITSUBISHI

L300

FRONT

P/VAN.STARWAGON

Year

1982-2002

MI1317
Outer Tie Rod End Set
(Ø13.4*Ø15.1/M14*1.5)

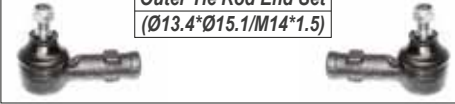

MI1318
Inner Tie Rod End Set
(Ø13.3*Ø15/M14*1.5)

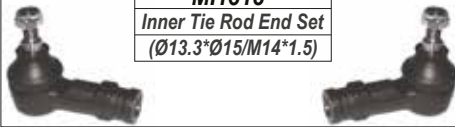

MI1013
Outer Tie Rod End
(Ø13.4*Ø15.1/M14*1.5)



MI1115
Inner Tie Rod End
(Ø13.3*Ø15/M14*1.5)



MI1013
Outer Tie Rod End
(Ø13.4*Ø15.1/M14*1.5)



MI1610
Upper Ball Joint
(Ø16)



MI1718
Upper Control Arm

MI1718
Upper Control Arm

MI1610
Upper Ball Joint
(Ø16)



HY1922
Lower Ball Joint
(Ø19.67)



HY1922
Lower Ball Joint
(Ø19.67)



MI2514
Idler Arm



LEFT

RIGHT

mitsubishi

LANCER

FRONT

CS-A

Year

2003-

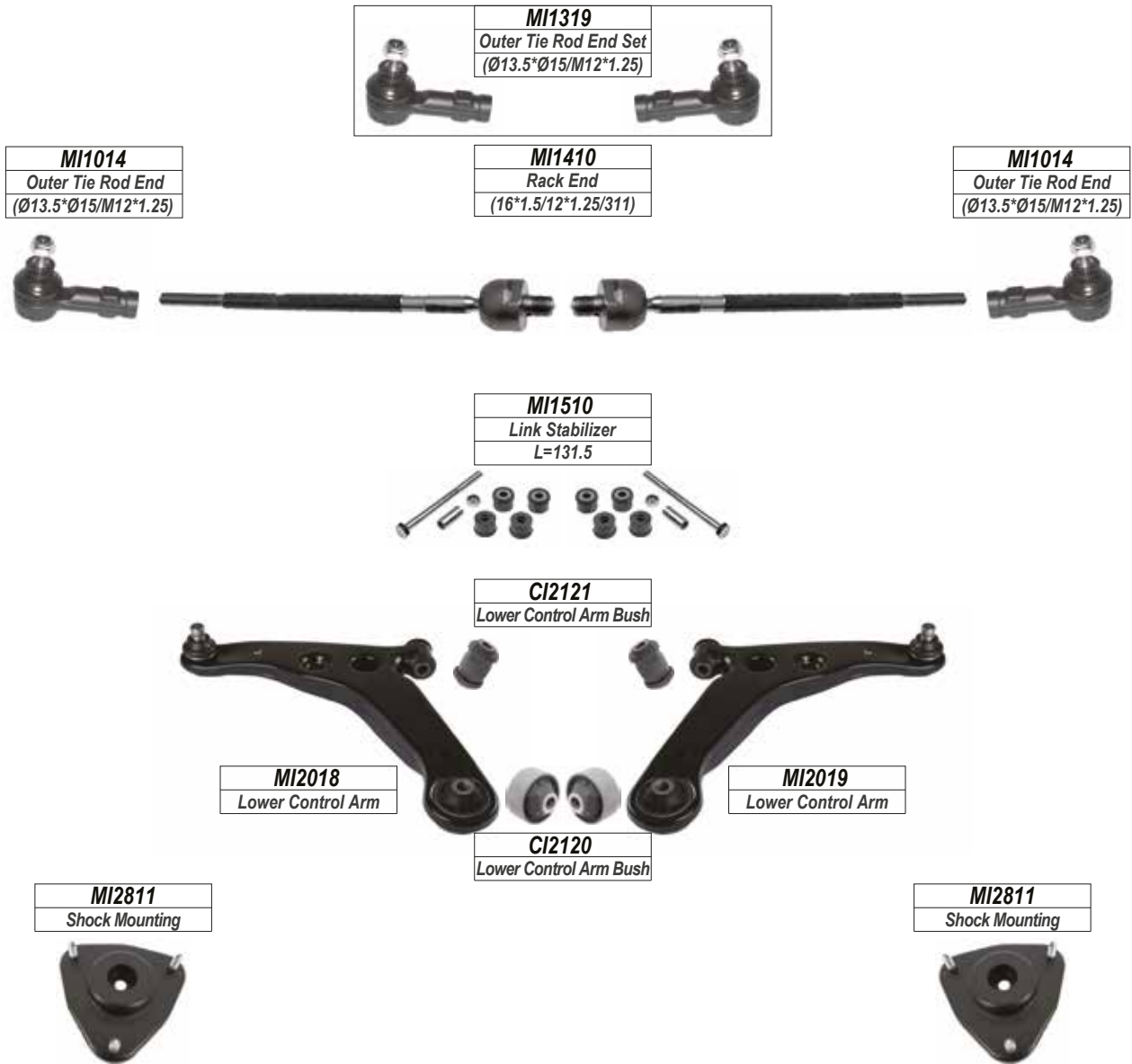

LANCER

REAR



LEFT

RIGHT

mitsubishi

LANCER

FRONT

SPORTBACK

Year

2008-

CI1029
Outer Tie Rod End
(Ø13.45*Ø15.1/M14*1.5)

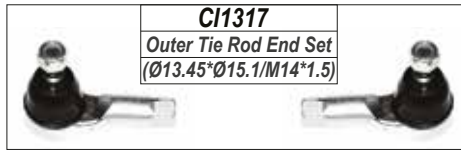

CI1317
Outer Tie Rod End Set
(Ø13.45*Ø15.1/M14*1.5)

CI1029
Outer Tie Rod End
(Ø13.45*Ø15.1/M14*1.5)



CI1420
Rack End
(14*1.5/14*1.5/341)



CI1516
Link Stabilizer
L=265



CI2121
Lower Control Arm Bush



CI1910
Lower Ball Joint
(Ø20)



CI2020
Lower Control Arm

CI2021
Lower Control Arm

CI1910
Lower Ball Joint
(Ø20)



CI2120
Lower Control Arm Bush



LANCER

REAR

DO1511 / DO1512
Link Stabilizer
L=80



MI2610
Lateral Link



MI2610
Lateral Link

LEFT

RIGHT

mitsubishi

OUTLANDER

FRONT

Year

2003-2008

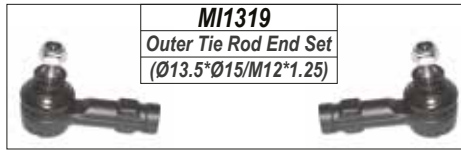

MI1014
Outer Tie Rod End
(Ø13.5*Ø15/M12*1.25)

MI1410
Rack End
(16*1.5/12*1.25/311)

MI1014
Outer Tie Rod End
(Ø13.5*Ø15/M12*1.25)



MI2022
Lower Control Arm

MI2023
Lower Control Arm

LEFT

RIGHT

MITSUBISHI

OUTLANDER

FRONT

Year

2006-2014

II

CI1029
Outer Tie Rod End
(Ø13.45*Ø15.1/M14*1.5)

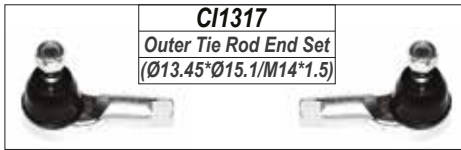

CI1317
Outer Tie Rod End Set
(Ø13.45*Ø15.1/M14*1.5)

CI1420
Rack End
(14*1.5/14*1.5/341)

CI1029
Outer Tie Rod End
(Ø13.45*Ø15.1/M14*1.5)



MI1411
Rack End
(14*1.5/14*1.5/324)



CI1516
Link Stabilizer
L=265



CI2121
Lower Control Arm Bush



CI1910
Lower Ball Joint
(Ø20)



CI2020
Lower Control Arm

CI2021
Lower Control Arm

CI1910
Lower Ball Joint
(Ø20)



MI2810
Shock Mounting



CI2120
Lower Control Arm Bush



MI2810
Shock Mounting



OUTLANDER

REAR

DO1511 / DO1512
Link Stabilizer
L=80



LEFT

RIGHT

MITSUBISHI

PAJERO

FRONT

Year

1983-1994

MI2210

Center Rod



MI1312

Outer Tie Rod End Set
(Ø13.6*Ø15.8/M16*1.5)

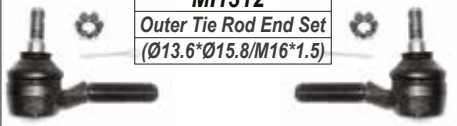

MI1313

Inner Tie Rod End Set
(Ø13.7*Ø16.2/M16*1.5)



MI1012

Outer Tie Rod End
(Ø13.6*Ø15.8/M16*1.5)



MI1113

Inner Tie Rod End
(Ø13.7*Ø16.2/M16*1.5)



MI1012

Outer Tie Rod End
(Ø13.6*Ø15.8/M16*1.5)



MI1610

Upper Ball Joint
(Ø16)



MI1113

Inner Tie Rod End
(Ø13.7*Ø16.2/M16*1.5)



MI1610

Upper Ball Joint
(Ø16)



MI1712

Upper Control Arm

MI1713

Upper Control Arm

MI1910

Lower Ball Joint
(Ø19.5)



MI2111

Lower Control Arm Bush



MI1910

Lower Ball Joint
(Ø19.5)



MI2012

Lower Control Arm

MI2013

Lower Control Arm

MI2512

Pitman Arm



MI2414

Idler Arm



LEFT

RIGHT

MITSUBISHI

PAJERO

FRONT

II

Year

1990-2000

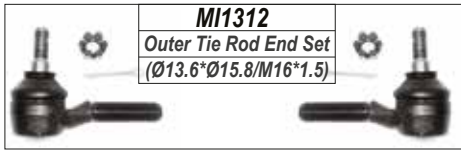

MI1312
Outer Tie Rod End Set
(Ø13.6*Ø15.8/M16*1.5)



MI1313
Inner Tie Rod End Set
(Ø13.7*Ø16.2/M16*1.5)

MI1012
Outer Tie Rod End
(Ø13.6*Ø15.8/M16*1.5)



MI1113
Inner Tie Rod End
(Ø13.7*Ø16.2/M16*1.5)



MI1012
Outer Tie Rod End
(Ø13.6*Ø15.8/M16*1.5)



MI1512 / MI1513
Link Stabilizer
L=78



MI1612
Upper Ball Joint
(Ø16)



MI1612
Upper Ball Joint
(Ø16)



MI1611
Upper Ball Joint
(Ø16)



MI1611
Upper Ball Joint
(Ø16)



MI1714
Upper Control Arm



MI1715
Upper Control Arm



MI1911
Lower Ball Joint
(Ø19.45)



MI1912
Lower Ball Joint
(Ø19.45)



MI2014
Lower Control Arm



MI2015
Lower Control Arm



MI2515
Pitman Arm



MI2111
Lower Control Arm Bush



MI2415
Idler Arm



LEFT

RIGHT

MITSUBISHI

PAJERO

FRONT

Year

2000-2007

III.IV

MI1015
Outer Tie Rod End
(Ø13.65*Ø15.9/M16*1.5)



MI1017
Outer Tie Rod End
(Ø13.7*Ø16.2/M16*1.5)

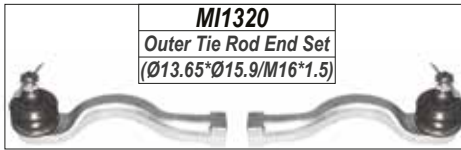

MI1320
Outer Tie Rod End Set
(Ø13.65*Ø15.9/M16*1.5)



MI1321
Outer Tie Rod End Set
(Ø13.7*Ø16.2/M16*1.5)

MI1412
Rack End
(16*1.5/16*1.5/206)

MI1016
Outer Tie Rod End
(Ø13.5*Ø15/M12*1.25)



MI1018
Outer Tie Rod End
(Ø13.7*Ø16.2/M16*1.5)



MI1514 / MI1515
Link Stabilizer
L=78

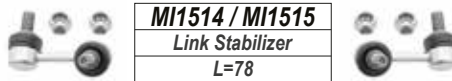

MI1516 / MI1517
Link Stabilizer
L=78

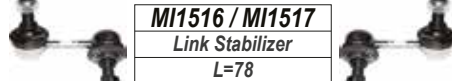

MI1612
Upper Ball Joint
(Ø16)



MI1719
Upper Control Arm



MI1720
Upper Control Arm



MI1612
Upper Ball Joint
(Ø16)

MI1611
Upper Ball Joint
(Ø16)



MI1611
Upper Ball Joint
(Ø16)

MI2112
Lower Control Arm Bush



MI2024
Lower Control Arm

MI2025
Lower Control Arm

MI2113
Lower Control Arm Bush

MI1913
Lower Ball Joint
(Ø19.5)



MI1913
Lower Ball Joint
(Ø19.5)

PAJERO

REAR

MI1518 / MI1519
Link Stabilizer
L=115



MI1914
Lower Ball Joint
(Ø19.2)



MI1914
Lower Ball Joint
(Ø19.2)

LEFT

RIGHT

MITSUBISHI

TRITON

FRONT

ALL MODEL

Year

2007-

MI1015
Outer Tie Rod End
(Ø13.65*Ø15.9/M16*1.5)

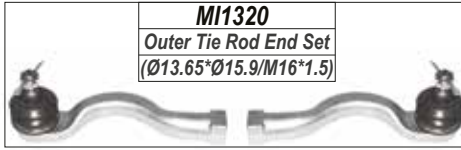

MI1320
Outer Tie Rod End Set
(Ø13.65*Ø15.9/M16*1.5)

MI1412
Rack End
(16*1.5/16*1.5/206)



MI1016
Outer Tie Rod End
(Ø13.5*Ø15/M12*1.25)



MI1514 / MI1515
Link Stabilizer
L=78



MI1516 / MI1517
Link Stabilizer
L=78



MI1612
Upper Ball Joint
(Ø16)



MI1721
Upper Control Arm



MI1722
Upper Control Arm

MI1612
Upper Ball Joint
(Ø16)



MI1913
Lower Ball Joint
(Ø19.5)



MI2026
Lower Control Arm



MI1913
Lower Ball Joint
(Ø19.5)

MI2027
Lower Control Arm

PAJERO

REAR

MI1518 / MI1519
Link Stabilizer
L=115



MI1914
Lower Ball Joint
(Ø19.2)



MI1914
Lower Ball Joint
(Ø19.2)



LEFT

RIGHT

NISSAN

1200.1400.1600.1800j FRONT

BAKKIE.SEDAN

Year

1971-1984



NI1024	
Outer Tie Rod End	
(Ø11.4*Ø13.4/M14*1.5)	



NI1114 / NI1115	
Inner Tie Rod End	
(Ø11.4*Ø13.4/M14*1.5)	



NI1025	
Outer Tie Rod End	
(Ø11.4*Ø13.4/M14*1.5)	



NI1910	
Lower Ball Joint(1.6*1.8)	
(Ø15)	



NI1910	
Lower Ball Joint(1.6*1.8)	
(Ø15)	



NI1911	
Lower Ball Joint(1.2*1.4)	
(Ø15)	



NI1911	
Lower Ball Joint(1.2*1.4)	
(Ø15)	



NI1912	
Lower Ball Joint(1.40Y)	
(Ø15)	



NI1912	
Lower Ball Joint(1.40Y)	
(Ø15)	



NI2811	
Shock Mounting	



NI2811	
Shock Mounting	



LEFT

RIGHT

NISSAN

680.720

FRONT

D21 4X4.4X2

Year

1980-1988

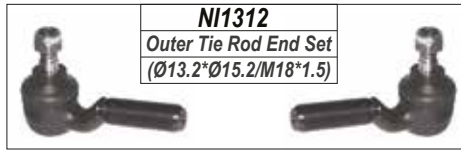

NI1026
<i>Outer Tie Rod End</i>
<i>(Ø13.2*Ø15.2/M18*1.5)</i>



NI1116
<i>Inner Tie Rod End</i>
<i>(Ø13.2*Ø15.2/M18*1.5)</i>



NI1026
<i>Outer Tie Rod End</i>
<i>(Ø13.2*Ø15.2/M18*1.5)</i>



NI1210
<i>Tie Rod Assembly</i>



NI1613
<i>Upper Ball Joint</i>
<i>(Ø16)</i>



NI1613
<i>Upper Ball Joint</i>
<i>(Ø16)</i>



NI1923
<i>Lower Ball Joint</i>
<i>(Ø19.5)</i>



NI1924
<i>Lower Ball Joint</i>
<i>(Ø19.5)</i>



LEFT

RIGHT

NISSAN

720

FRONT

D21 2.2 KINGCAB.4WD

Year

1984-1988

NI2210
Center Rod

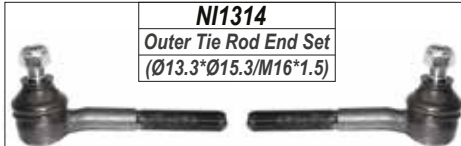

NI1010
Outer Tie Rod End (Ø13.3*Ø15.3/M16*1.5)



NI1110
Inner Tie Rod End (Ø13.3*Ø15.3/M16*1.5)



NI1010
Outer Tie Rod End (Ø13.3*Ø15.3/M16*1.5)



NI1613
Upper Ball Joint (Ø16)



NI1613
Upper Ball Joint (Ø16)



NI1913
Lower Ball Joint (Ø19.6)



NI1913
Lower Ball Joint (Ø19.6)



NI2410
Idler Arm



LEFT

RIGHT

NISSAN

**1 TONNER
HARDBODY/SANI**

FRONT

AW/D22 4X2

Year

1988-1998

NI2212
Center Rod



NI1026
Outer Tie Rod End
(Ø13.2*Ø15.2/M18*1.5)



NI1116
Inner Tie Rod End
(Ø13.2*Ø15.2/M18*1.5)



NI1026
Outer Tie Rod End
(Ø13.2*Ø15.2/M18*1.5)



NI1510
Link Stabilizer
L=150



NI1613
Upper Ball Joint
(Ø16)



NI1710
Upper Control Arm



NI1711
Upper Control Arm



NI1613
Upper Ball Joint
(Ø16)

NI1925
Lower Ball Joint
(Ø19.7)



NI2010
Lower Control Arm



NI2011
Lower Control Arm



NI1925
Lower Ball Joint
(Ø19.7)

NI2413
Idler Arm



NI2510
Pitman Arm



NI2511
Pitman Arm



LEFT

RIGHT

NISSAN

1 TONNER
HARDBODY

FRONT

D22 4WD

Year

1988-1998

NI2210
Center Rod

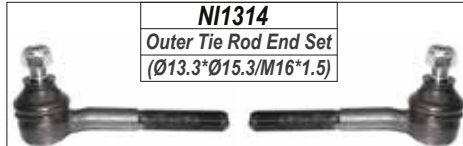

NI1010 Outer Tie Rod End (Ø13.3*Ø15.3/M16*1.5)



NI1110 Inner Tie Rod End (Ø13.3*Ø15.3/M16*1.5)



NI1010 Outer Tie Rod End (Ø13.3*Ø15.3/M16*1.5)



NI1613 Upper Ball Joint (Ø16)
--



NI2145 Lower Control Arm Bush



NI1613 Upper Ball Joint (Ø16)
--

NI1712 Upper Control Arm



NI1713 Upper Control Arm



NI1913 Lower Ball Joint (Ø19.6)
--



NI2134 Lower Control Arm Bush



NI1913 Lower Ball Joint (Ø19.6)
--



NI2012 Lower Control Arm



NI2013 Lower Control Arm



NI2410 Idler Arm



LEFT

RIGHT

NISSAN

HARDBODY

FRONT

2WD

Year

1998-2001

NI2213

Center Rod(M/S)



NI2214

Center Rod(P/S)



NI1316

Outer Tie Rod End Set
(Ø14.4*Ø16.4/M18*1.5)

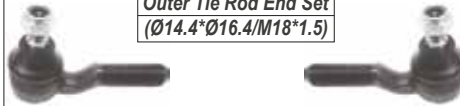

NI1317

Inner Tie Rod End Set
(Ø14.4*Ø16.4/M18*1.5)

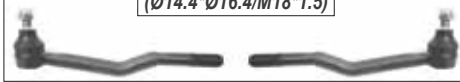

NI1027

Outer Tie Rod End
(Ø14.4*Ø16.4/M18*1.5)



NI1117

Inner Tie Rod End
(Ø14.4*Ø16.4/M18*1.5)



NI1027

Outer Tie Rod End
(Ø14.4*Ø16.4/M18*1.5)



NI1211

Tie Rod Assembly



NI1614

Upper Ball Joint
(Ø16.2)



NI1813

Upper Control Arm Bush



NI1614

Upper Ball Joint
(Ø16.2)



NI1714

Upper Control Arm



NI1715

Upper Control Arm



NI1925

Lower Ball Joint
(Ø19.7)



NI1925

Lower Ball Joint
(Ø19.7)



NI2010

Lower Control Arm



NI2011

Lower Control Arm

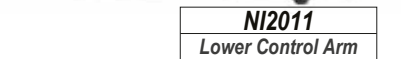

NI2413

Idler Arm(M/S)



NI2411

Idler Arm(P/S)



LEFT

RIGHT

NISSAN

**HARDBODY/SANI
NP300**

FRONT

D22/D25 2WD-STD/HI RIDER

Year

01-08/98-99/08-

NI2212
Center Rod(Hi-Rider)

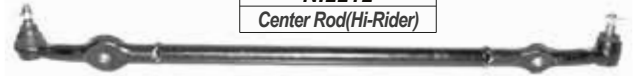

NI2213
Center Rod(M/S)



NI2214
Center Rod(P/S)



NI1318(Hi-Rider)
Outer Tie Rod End Set
(Ø14.6*Ø18.6/M14*1.5)



NI1319(Hi-Rider)
Inner Tie Rod End Set
(Ø15*Ø17/M14*1.5)

NI1011(Hi-Rider)
Outer Tie Rod End
(Ø14.6*Ø18.6/M14*1.5)



NI1118(Hi-Rider)
Inner Tie Rod End
(Ø15*Ø17/M14*1.5)



NI1011(Hi-Rider)
Outer Tie Rod End
(Ø14.6*Ø18.6/M14*1.5)



NI1212
Tie Rod Assembly

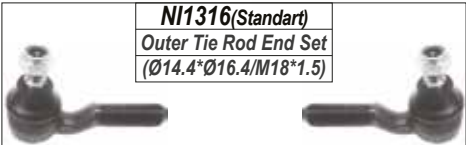

NI1316(Standart)
Outer Tie Rod End Set
(Ø14.4*Ø16.4/M18*1.5)



NI1317(Standart)
Inner Tie Rod End Set
(Ø14.4*Ø16.4/M18*1.5)

NI1027(Standart)
Outer Tie Rod End
(Ø14.4*Ø16.4/M18*1.5)



NI1117(Standart)
Inner Tie Rod End
(Ø14.4*Ø16.4/M18*1.5)



NI1027(Standart)
Outer Tie Rod End
(Ø14.4*Ø16.4/M18*1.5)



NI1211
Tie Rod Assembly



LEFT

RIGHT

NISSAN

HARDBODY/SANI FRONT NP300

D22/D25 2WD-STD/HI RIDER

Year

01-08/98-99/08-



NI2413
Idler Arm(M/S)



NI2411
Idler Arm(P/S)



LEFT

RIGHT

NISSAN

HARDBODY/NP300 FRONT

4WD

Year

1998-2010

NI2211
Center Rod



NI1318
Outer Tie Rod End Set
(Ø14.6*Ø18.6/M14*1.5)

NI1319
Inner Tie Rod End Set
(Ø15*Ø17/M14*1.5)

NI1011
Outer Tie Rod End
(Ø14.6*Ø18.6/M14*1.5)



NI1118
Inner Tie Rod End
(Ø15*Ø17/M14*1.5)



NI1011
Outer Tie Rod End
(Ø14.6*Ø18.6/M14*1.5)



NI1212
Tie Rod Assembly



NI1614
Upper Ball Joint
(Ø16.2)



NI1813
Upper Control Arm Bush



NI1614
Upper Ball Joint
(Ø16.2)



NI1716
Upper Control Arm



NI1717
Upper Control Arm



NI1914
Lower Ball Joint
(Ø19.7)



NI2134
Lower Control Arm Bush



NI1914
Lower Ball Joint
(Ø19.7)



NI2014
Lower Control Arm



NI2412
Idler Arm



NI2015
Lower Control Arm



LEFT

RIGHT

NISSAN

ALMERA

FRONT

ALL MODELS

Year

2001-2006

NI1028
Outer Tie Rod End
(Ø13*Ø15.5/M14*1.5)



NI1320
Outer Tie Rod End Set
(Ø13*Ø15.5/M14*1.5)

NI1410
Rack End
(16*1.0/14*1.5/286)

NI1028
Outer Tie Rod End
(Ø13*Ø15.5/M14*1.5)



NI1029
Outer Tie Rod End
(Ø13*Ø15.5/M12*1.25)

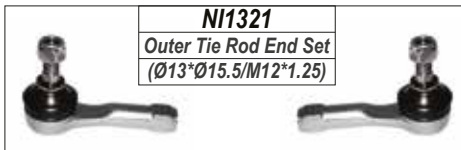

NI1321
Outer Tie Rod End Set
(Ø13*Ø15.5/M12*1.25)

NI1411
Rack End
(16*1.0/12*1.25/285)

NI1029
Outer Tie Rod End
(Ø13*Ø15.5/M12*1.25)



NI1511
Link Stabilizer
L=92.5

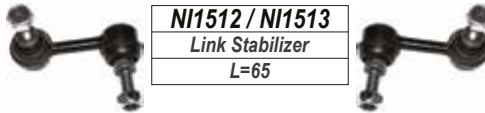

NI1512 / NI1513
Link Stabilizer
L=65

NI2810
Stabilizer Bar Bush



NI2810
Stabilizer Bar Bush



NI1926
Lower Ball Joint
(Ø14.75)



NI2110
Lower Control Arm Bush



NI1926
Lower Ball Joint
(Ø14.75)



NI2016
Lower Control Arm



NI2017
Lower Control Arm

NI2812
Shock Mounting



NI2111
Lower Control Arm Bush



NI2812
Shock Mounting



LEFT

RIGHT

NISSAN

ALMERA

FRONT

ALL MODELS

Year

2013-

DT1010
Outer Tie Rod End
(Ø11.7*Ø14.6/M12*1.25)



DT1310
Outer Tie Rod End Set
(Ø11.7*Ø14.6/M12*1.25)

DT1011
Outer Tie Rod End
(Ø11.7*Ø14.6/M12*1.25)



DT1410
Rack End
(14*1.5/12*1.25/227)



NI1514
Link Stabilizer
L=255



DT2110
Lower Control Arm Bush



DT1910
Lower Ball Joint
(Ø16)



DT2010
Lower Control Arm

DT2011
Lower Control Arm

DT1910
Lower Ball Joint
(Ø16)



DT2111
Lower Control Arm Bush



NI2813
Shock Mounting



NI2813
Shock Mounting



LEFT

RIGHT

NISSAN

INTERSTAR

FRONT

ALL MODELS

Year

2005-

NI1012
Outer Tie Rod End
(Ø16.4*Ø20.2/M16*1.5)



NI1322
Outer Tie Rod End Set
(Ø16.4*Ø20.2/M16*1.5)

NI1013
Outer Tie Rod End
(Ø16.4*Ø20.2/M16*1.5)



NI1413
Rack End
(14*1.5/16*1.5/178)



NI1515 / NI1516
Link Stabilizer
L=127



NI1610
Upper Ball Joint
(Ø16.1)



NI1610
Upper Ball Joint
(Ø16.1)



NI1915
Lower Ball Joint
(Ø22)



NI2112
Lower Control Arm Bush



NI1915
Lower Ball Joint
(Ø22)



NI2018
Lower Control Arm

NI2019
Lower Control Arm

NI1916
Lower Ball Joint
(Ø24)



NI2113
Lower Control Arm Bush

NI2112
Lower Control Arm Bush



NI1916
Lower Ball Joint
(Ø24)



NI2020
Lower Control Arm

NI2021
Lower Control Arm

NI2113
Lower Control Arm Bush

INTERSTAR

REAR

NI2910
Bush



LEFT

RIGHT

NISSAN

JUKE

FRONT

ALL MODELS

Year

2010-

NI1014
Outer Tie Rod End
(Ø11.9*Ø14.7/M12*1.25)



NI1323
Outer Tie Rod End Set
(Ø11.9*Ø14.7/M12*1.25)

NI1015
Outer Tie Rod End
(Ø11.9*Ø14.7/M12*1.25)



NI1414
Rack End
(16*1.0/12*1.25/217)



NI1517
Link Stabilizer
L=284



NI2144
Lower Control Arm Bush



NI1927
Lower Ball Joint
(Ø18)



NI1927
Lower Ball Joint
(Ø18)

NI2022
Lower Control Arm

NI2023
Lower Control Arm

NI2115
Lower Control Arm Bush



NI2826
Shock Mounting



NI2827
Shock Mounting



LEFT

RIGHT

NISSAN

MAXIMA

FRONT

ALL MODELS

Year

1991-1996

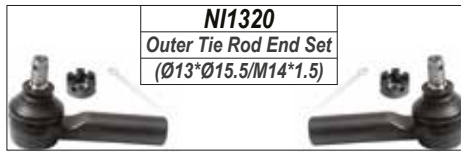

NI1028
Outer Tie Rod End
(Ø13*Ø15.5/M14*1.5)

NI1415
Rack End
(16*1.0/14*1.5/308)

NI1028
Outer Tie Rod End
(Ø13*Ø15.5/M14*1.5)



NI1416
Rack End
(16*1.0/14*1.5/310)



NI1427
Rack End
(16*1.0/14*1.5/261)



NI1518
Link Stabilizer
L=84.5



NI1928
Lower Ball Joint
(Ø14.76)



NI1928
Lower Ball Joint
(Ø14.76)



NI2024
Lower Control Arm



NI2025
Lower Control Arm



NI2116
Lower Control Arm Bush

LEFT

RIGHT

NISSAN

MAXIMA

FRONT

A32

Year

1996-2000

NI1028
Outer Tie Rod End
(Ø13*Ø15.5/M14*1.5)

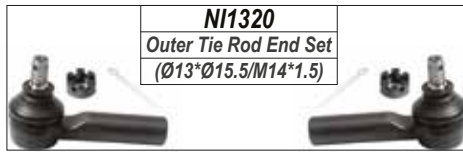

NI1320
Outer Tie Rod End Set
(Ø13*Ø15.5/M14*1.5)

NI1415
Rack End
(16*1.0/14*1.5/308)

NI1028
Outer Tie Rod End
(Ø13*Ø15.5/M14*1.5)



NI1519
Link Stabilizer
L=98



NI1520 / NI1521
Link Stabilizer
L=90



NI1917
Lower Ball Joint
(Ø11.6)



NI2026
Lower Control Arm

NI2027
Lower Control Arm

NI1917
Lower Ball Joint
(Ø11.6)



LEFT

RIGHT

NISSAN

MAXIMA

FRONT

A33.QX

Year

2000-

NI1028
Outer Tie Rod End
(Ø13*Ø15.5/M14*1.5)

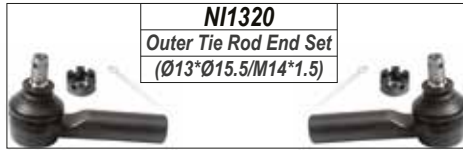

NI1320
Outer Tie Rod End Set
(Ø13*Ø15.5/M14*1.5)

NI1415
Rack End
(16*1.0/14*1.5/308)

NI1028
Outer Tie Rod End
(Ø13*Ø15.5/M14*1.5)



NI1416
Rack End
(16*1.0/14*1.5/310)



NI1519
Link Stabilizer
L=98



NI1520 / NI1521
Link Stabilizer
L=90



NI1929
Lower Ball Joint
(Ø15)



NI2028
Lower Control Arm



NI2029
Lower Control Arm

NI1929
Lower Ball Joint
(Ø15)



LEFT

RIGHT

NISSAN

MICRA

FRONT

K12

Year

2004-2010

NI1016
Outer Tie Rod End
(Ø11.8*Ø15/M14*1.5)



NI1419
Rack End
(14*1.5/14*1.5/308)



NI1017
Outer Tie Rod End
(Ø11.8*Ø15/M14*1.5)

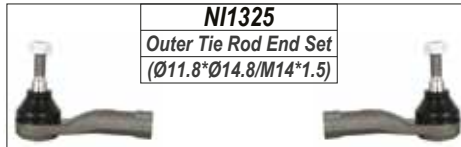

NI1325
Outer Tie Rod End Set
(Ø11.8*Ø14.8/M14*1.5)

NI1018
Outer Tie Rod End
(Ø11.8*Ø14.8/M14*1.5)



NI1030
Outer Tie Rod End
(Ø11.8*Ø14.8/M14*1.5)



NI1522
Link Stabilizer
L=248



NI2117
Lower Control Arm Bush

NI1918
Lower Ball Joint
(Ø16)



NI2030
Lower Control Arm

NI2031
Lower Control Arm

NI1918
Lower Ball Joint
(Ø16)



NI2118
Lower Control Arm Bush



NI2814
Shock Mounting



NI2911
Bush



NI2815
Shock Mounting



LEFT

RIGHT

NISSAN

MICRA

FRONT

K13

Year

2010-

DT1010
Outer Tie Rod End
(Ø11.7*Ø14.6/M12*1.25)



DT1310
Outer Tie Rod End Set
(Ø11.7*Ø14.6/M12*1.25)

DT1011
Outer Tie Rod End
(Ø11.7*Ø14.6/M12*1.25)



DT1410
Rack End
(14*1.5/12*1.25/227)



NI1514
Link Stabilizer
L=255



DT2110
Lower Control Arm Bush



DT1910
Lower Ball Joint
(Ø16)



DT2010
Lower Control Arm

DT2011
Lower Control Arm

DT1910
Lower Ball Joint
(Ø16)



DT2111
Lower Control Arm Bush



NI2816
Shock Mounting



NI2816
Shock Mounting



LEFT

RIGHT

NISSAN

MURANO

FRONT

Z50

Year

2005-2009

NI1031
Outer Tie Rod End
(Ø14.8*Ø18.6/M14*1.5)



NI1326
Outer Tie Rod End Set
(Ø14.8*Ø18.6/M14*1.5)

NI1420
Rack End
(16*1.0/14*1.5/262)

NI1031
Outer Tie Rod End
(Ø14.8*Ø18.6/M14*1.5)



NI1523 / NI1524
Link Stabilizer
L=308



NI1930
Lower Ball Joint
(Ø20)



NI2138
Lower Control Arm Bush



NI2032
Lower Control Arm

NI2033
Lower Control Arm

NI1930
Lower Ball Joint
(Ø20)



NI2137
Lower Control Arm Bush



NI2817
Shock Mounting



NI2817
Shock Mounting



MURANO

REAR

NI1525 / NI1526
Link Stabilizer
L=85



LEFT

RIGHT

NISSAN

MURANO

FRONT

Z51

Year

2009-

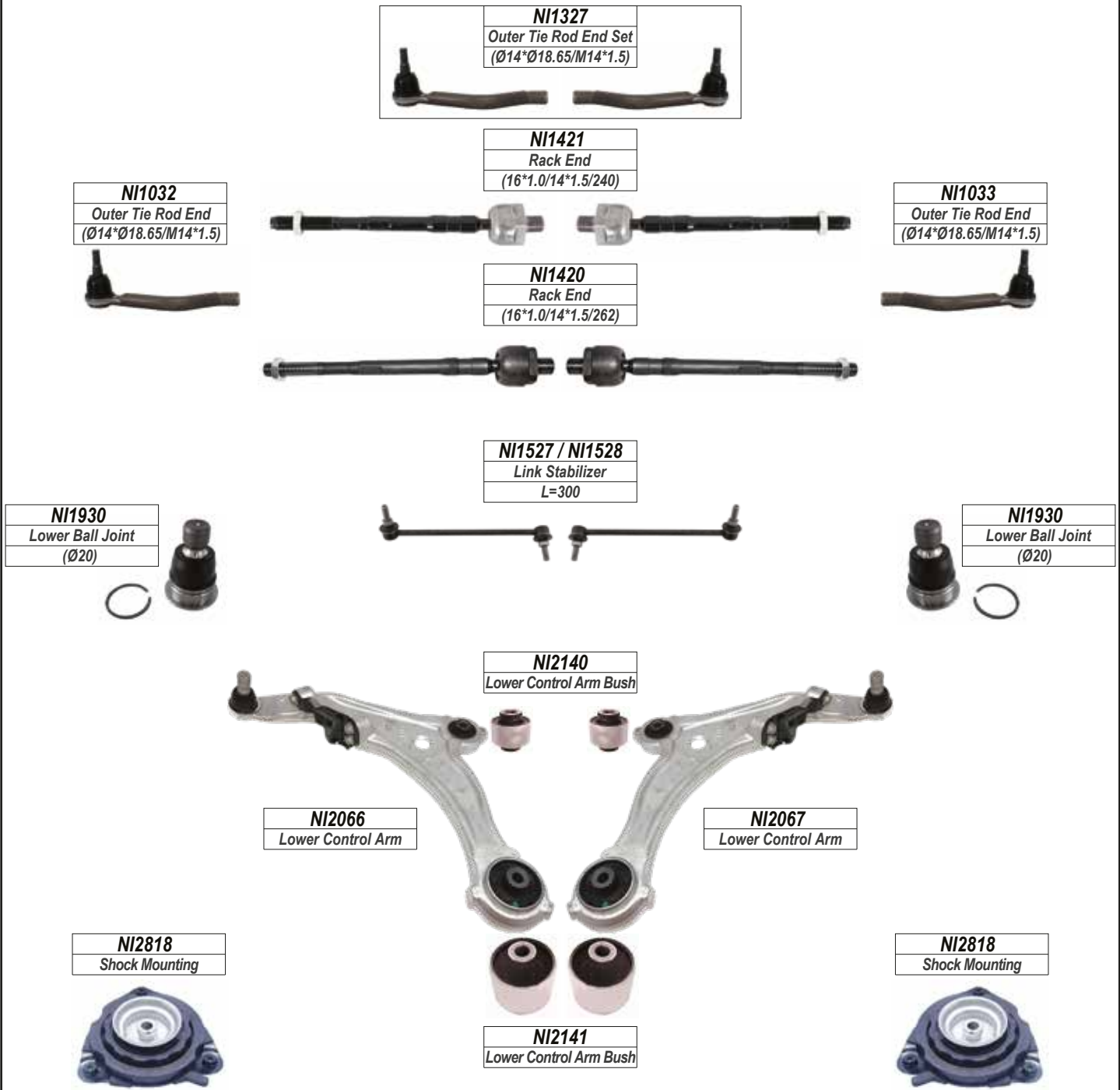

MURANO

REAR



LEFT

RIGHT

NISSAN

NAVARA
PATHFINDER

FRONT

ALL MODELS

Year

2005-

NI1034
Outer Tie Rod End
(Ø14.8*Ø18.63/M16*1.5)



NI1422
Rack End
(20*1.0/16*1.5/202)



NI1035
Outer Tie Rod End
(Ø14.8*Ø18.63/M16*1.5)



NI1328
Outer Tie Rod End Set
(Ø14.8*Ø18.63/M16*1.5)

NI1531 / NI1532
Link Stabilizer
L=65



NI1611
Upper Ball Joint
(Ø14.75)

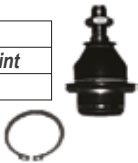

NI1718
Upper Control Arm

NI2139
Upper Control Arm Bush



NI1719
Upper Control Arm

NI1611
Upper Ball Joint
(Ø14.75)



NI1919
Lower Ball Joint
(Ø22)



NI2034
Lower Control Arm

NI2035
Lower Control Arm

NI2119
Lower Control Arm Bush

NI1919
Lower Ball Joint
(Ø22)



NI2820
Shock Mounting



NI2820
Shock Mounting



LEFT

RIGHT

NISSAN

NAVARA

FRONT

ALL MODELS

Year

2016-

NI1019
Outer Tie Rod End
(Ø14.7*Ø18/M14*1.5)



NI1329
Outer Tie Rod End Set
(Ø14.7*Ø18/M14*1.5)

NI1417
Rack End
(16*1.5/14*1.5/214)

NI1020
Outer Tie Rod End
(Ø14.7*Ø18/M14*1.5)



NI1533
Link Stabilizer
L=210



NI1612
Upper Ball Joint
(Ø14.8)



NI1810
Upper Control Arm Bush

NI1612
Upper Ball Joint
(Ø14.8)



NI1720
Upper Control Arm

NI1721
Upper Control Arm

NI1920
Lower Ball Joint
(Ø24)



NI2120
Lower Control Arm Bush

NI1920
Lower Ball Joint
(Ø24)



NI2036
Lower Control Arm

NI2037
Lower Control Arm

LEFT

RIGHT

NISSAN











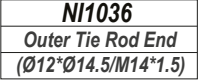





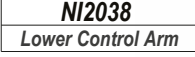
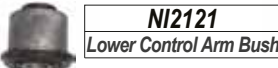

NP200

FRONT

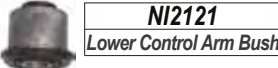
ALL MODELS

Year

2008-

	<table border="1" style="margin: 0 auto;"> <tr><td style="text-align: center;">NI1330</td></tr> <tr><td style="text-align: center;">Outer Tie Rod End Set (Ø12*Ø14.5/M14*1.5)</td></tr> </table> 	NI1330	Outer Tie Rod End Set (Ø12*Ø14.5/M14*1.5)					
NI1330								
Outer Tie Rod End Set (Ø12*Ø14.5/M14*1.5)								
<table border="1" style="margin: 0 auto;"> <tr><td style="text-align: center;">NI1036</td></tr> <tr><td style="text-align: center;">Outer Tie Rod End (Ø12*Ø14.5/M14*1.5)</td></tr> </table> 	NI1036	Outer Tie Rod End (Ø12*Ø14.5/M14*1.5)	<table border="1" style="margin: 0 auto;"> <tr><td style="text-align: center;">NI1423</td></tr> <tr><td style="text-align: center;">Rack End (12*1.0/14*1.5/194)</td></tr> </table> 	NI1423	Rack End (12*1.0/14*1.5/194)	<table border="1" style="margin: 0 auto;"> <tr><td style="text-align: center;">NI1037</td></tr> <tr><td style="text-align: center;">Outer Tie Rod End (Ø12*Ø14.5/M14*1.5)</td></tr> </table> 	NI1037	Outer Tie Rod End (Ø12*Ø14.5/M14*1.5)
NI1036								
Outer Tie Rod End (Ø12*Ø14.5/M14*1.5)								
NI1423								
Rack End (12*1.0/14*1.5/194)								
NI1037								
Outer Tie Rod End (Ø12*Ø14.5/M14*1.5)								
<table border="1" style="margin: 0 auto;"> <tr><td style="text-align: center;">MN1411</td></tr> <tr><td style="text-align: center;">Rack End (14*1.5/14*1.5/181)</td></tr> </table> 			MN1411	Rack End (14*1.5/14*1.5/181)				
MN1411								
Rack End (14*1.5/14*1.5/181)								
<table border="1" style="margin: 0 auto;"> <tr><td style="text-align: center;">NI1931</td></tr> <tr><td style="text-align: center;">Lower Ball Joint (Ø18)</td></tr> </table> 	NI1931	Lower Ball Joint (Ø18)		<table border="1" style="margin: 0 auto;"> <tr><td style="text-align: center;">NI1931</td></tr> <tr><td style="text-align: center;">Lower Ball Joint (Ø18)</td></tr> </table> 	NI1931	Lower Ball Joint (Ø18)		
NI1931								
Lower Ball Joint (Ø18)								
NI1931								
Lower Ball Joint (Ø18)								
<table border="1" style="margin: 0 auto;"> <tr><td style="text-align: center;">NI2038</td></tr> <tr><td style="text-align: center;">Lower Control Arm</td></tr> </table> 	NI2038	Lower Control Arm	<table border="1" style="margin: 0 auto;"> <tr><td style="text-align: center;">NI2121</td></tr> <tr><td style="text-align: center;">Lower Control Arm Bush</td></tr> </table> 	NI2121	Lower Control Arm Bush	<table border="1" style="margin: 0 auto;"> <tr><td style="text-align: center;">NI2039</td></tr> <tr><td style="text-align: center;">Lower Control Arm</td></tr> </table> 	NI2039	Lower Control Arm
NI2038								
Lower Control Arm								
NI2121								
Lower Control Arm Bush								
NI2039								
Lower Control Arm								
<table border="1" style="margin: 0 auto;"> <tr><td style="text-align: center;">NI1934</td></tr> <tr><td style="text-align: center;">Lower Ball Joint (Ø18)</td></tr> </table> 	NI1934	Lower Ball Joint (Ø18)		<table border="1" style="margin: 0 auto;"> <tr><td style="text-align: center;">NI1934</td></tr> <tr><td style="text-align: center;">Lower Ball Joint (Ø18)</td></tr> </table> 	NI1934	Lower Ball Joint (Ø18)		
NI1934								
Lower Ball Joint (Ø18)								
NI1934								
Lower Ball Joint (Ø18)								
<table border="1" style="margin: 0 auto;"> <tr><td style="text-align: center;">NI2068</td></tr> <tr><td style="text-align: center;">Lower Control Arm</td></tr> </table> 	NI2068	Lower Control Arm	<table border="1" style="margin: 0 auto;"> <tr><td style="text-align: center;">NI2121</td></tr> <tr><td style="text-align: center;">Lower Control Arm Bush</td></tr> </table> 	NI2121	Lower Control Arm Bush	<table border="1" style="margin: 0 auto;"> <tr><td style="text-align: center;">NI2069</td></tr> <tr><td style="text-align: center;">Lower Control Arm</td></tr> </table> 	NI2069	Lower Control Arm
NI2068								
Lower Control Arm								
NI2121								
Lower Control Arm Bush								
NI2069								
Lower Control Arm								
<table border="1" style="margin: 0 auto;"> <tr><td style="text-align: center;">NI2821</td></tr> <tr><td style="text-align: center;">Shock Mounting</td></tr> </table> 	NI2821	Shock Mounting	<table border="1" style="margin: 0 auto;"> <tr><td style="text-align: center;">RE2710</td></tr> <tr><td style="text-align: center;">Repair Kit</td></tr> </table> 	RE2710	Repair Kit	<table border="1" style="margin: 0 auto;"> <tr><td style="text-align: center;">RE2710</td></tr> <tr><td style="text-align: center;">Repair Kit</td></tr> </table> 	RE2710	Repair Kit
NI2821								
Shock Mounting								
RE2710								
Repair Kit								
RE2710								
Repair Kit								
<table border="1" style="margin: 0 auto;"> <tr><td style="text-align: center;">NI2821</td></tr> <tr><td style="text-align: center;">Shock Mounting</td></tr> </table> 	NI2821	Shock Mounting						
NI2821								
Shock Mounting								
LEFT		RIGHT						

NISSAN

NV200

FRONT

ALL MODELS

Year

2013-

NI1331
Outer Tie Rod End Set
(Ø11.85*Ø14.7/M12*1.25)



NI1038
Outer Tie Rod End
(Ø11.85*Ø14.7/M12*1.25)



NI1424
Rack End
(14*1.5/12*1.25/200)



NI1039
Outer Tie Rod End
(Ø11.85*Ø14.7/M12*1.25)



NI1514
Link Stabilizer
L=255



NI2117
Lower Control Arm Bush



NI1931
Lower Ball Joint
(Ø18)



NI1931
Lower Ball Joint
(Ø18)



NI2040
Lower Control Arm



NI2041
Lower Control Arm



NI2122
Lower Control Arm Bush



NI2822
Shock Mounting



NI2823
Shock Mounting



LEFT

RIGHT

NISSAN

NV350

FRONT

INPENDULO

Year

2014-

NI1040
Outer Tie Rod End
(Ø17.7*Ø21.6/M20*1.5)



NI1332
Outer Tie Rod End Set
(Ø17.7*Ø21.6/M20*1.5)

NI1425
Rack End
(24*1.5/20*1.5/275)



NI1040
Outer Tie Rod End
(Ø17.7*Ø21.6/M20*1.5)



NI1531 / NI1532
Link Stabilizer
L=65



NI1722
Upper Control Arm



NI1723
Upper Control Arm



NI2135
Lower Control Arm Bush



NI1932
Lower Ball Joint
(Ø19.7)



NI2042
Lower Control Arm



NI2136
Lower Control Arm Bush



NI2043
Lower Control Arm

NI1932
Lower Ball Joint
(Ø19.7)



LEFT

RIGHT

NISSAN

PATROL

FRONT

Y60

Year

1992-1998

NI1021
Outer Tie Rod End
(Ø15.4*Ø17.57/M30*1.5)

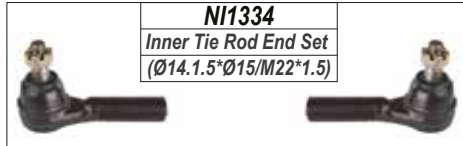
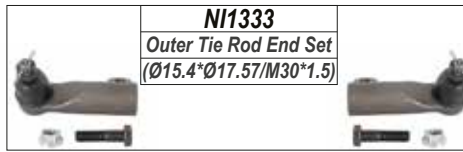

NI1111
Inner Tie Rod End
(Ø14.1.5*Ø15/M22*1.5)



NI1022
Outer Tie Rod End
(Ø15.4*Ø17.57/M30*1.5)



PATROL

REAR

NI1534
Link Stabilizer
L=130



LEFT

RIGHT

NISSAN

PATROL

FRONT

Year

Y61

1998-2004

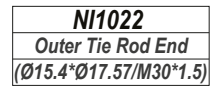
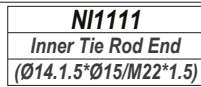
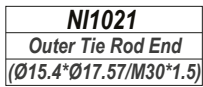
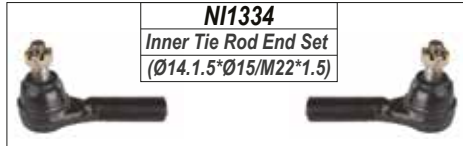
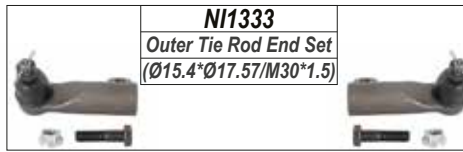

PATROL

REAR



LEFT

RIGHT

NISSAN

PRIMASTER

FRONT

ALL MODELS

Year

2007-

NI1041
Outer Tie Rod End
(Ø12*Ø14.6/M14*1.5)



NI1335
Outer Tie Rod End Set
(Ø12*Ø14.6/M14*1.5)

NI1426
Rack End
(12*1.0/14*1.5/263)



NI1042
Outer Tie Rod End
(Ø12*Ø14.6/M14*1.5)



NI1536
Link Stabilizer
L=279



NI1921
Lower Ball Joint
(Ø17.84)



NI2123
Lower Control Arm Bush



NI2044
Lower Control Arm

NI2045
Lower Control Arm

NI1921
Lower Ball Joint
(Ø17.84)

NI2122
Lower Control Arm Bush

NI2824
Shock Mounting



NI2824
Shock Mounting



LEFT

RIGHT

NISSAN

PRIMERA

FRONT

P11

Year

1998-2002

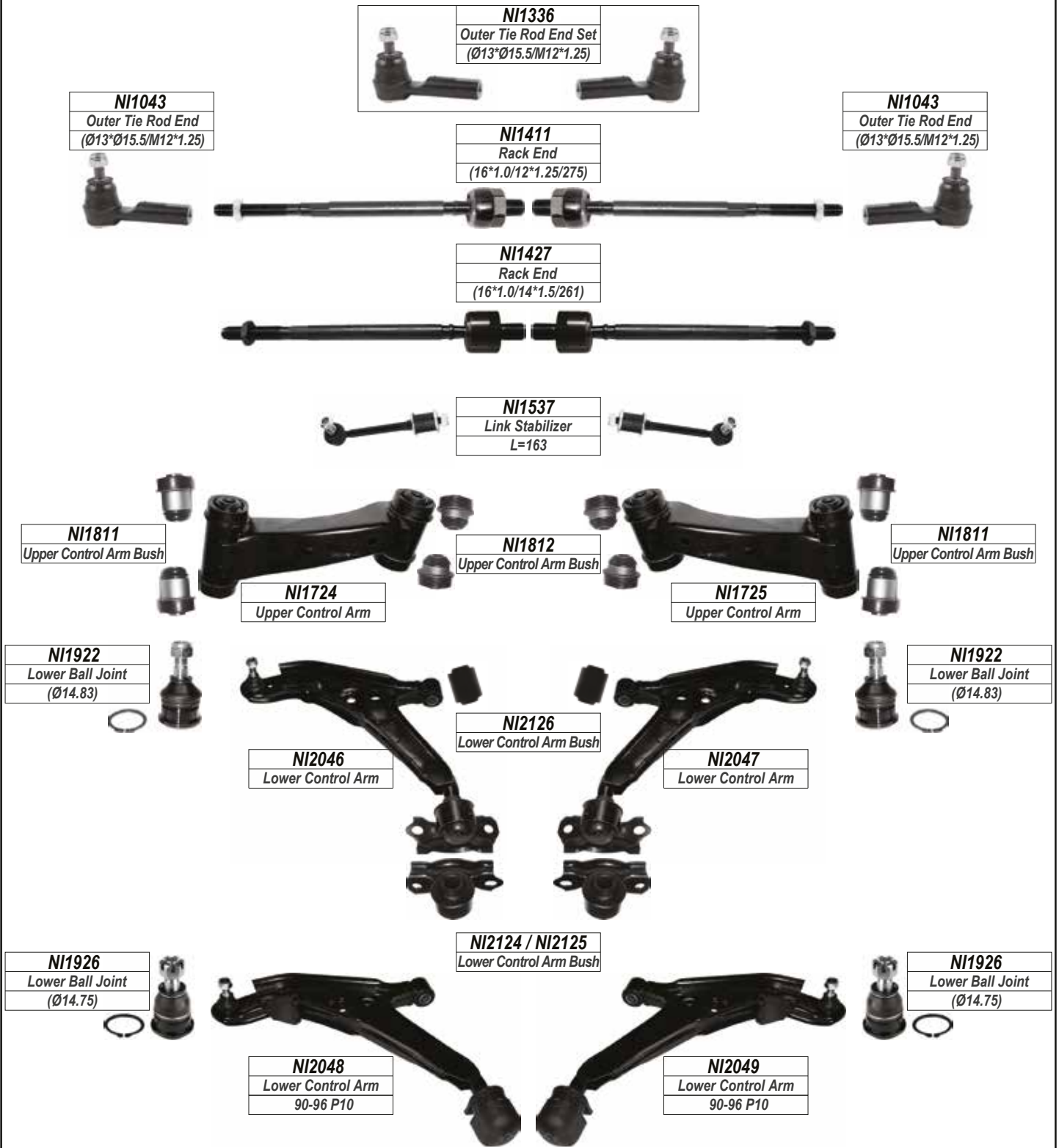

PRIMERA

REAR

NI1538

Link Stabilizer

L=115

LEFT



RIGHT

NISSAN

QASHQAI

FRONT

ALL MODELS

Year

2007-

NI1044
Outer Tie Rod End
(Ø11.8*Ø14.7/M14*1.5)



NI1337
Outer Tie Rod End Set
(Ø11.8*Ø14.7/M14*1.5)

NI1428
Rack End
(22*1.5/14*1.5/233)



NI1045
Outer Tie Rod End
(Ø11.8*Ø14.7/M14*1.5)



NI1527 / NI1528
Link Stabilizer
L=300



NI1930
Lower Ball Joint
(Ø20)



NI2127
Lower Control Arm Bush



NI2050
Lower Control Arm

NI2051
Lower Control Arm

NI1930
Lower Ball Joint
(Ø20)



NI2822
Shock Mounting



NI2114
Lower Control Arm Bush

NI2823
Shock Mounting



QASHQAI

REAR

NI1539 / NI1540
Link Stabilizer
L=143.5



LEFT

RIGHT

NISSAN

QASHQAI

FRONT

ALL MODELS

Year

2014-

NI1046
Outer Tie Rod End
(Ø11.8*Ø14.6/M14*1.5)



NI1338
Outer Tie Rod End Set
(Ø11.8*Ø14.6/M14*1.5)

RE1421
Rack End
(16*1.5/14*1.5/214)

NI1047
Outer Tie Rod End
(Ø11.8*Ø14.6/M14*1.5)



NI1517
Link Stabilizer
L=284



NI1930
Lower Ball Joint
(Ø20)



NI2128
Lower Control Arm Bush



NI2052
Lower Control Arm

NI2053
Lower Control Arm

NI1930
Lower Ball Joint
(Ø20)



NI2129
Lower Control Arm Bush

NI2828
Shock Mounting



NI2828
Shock Mounting



LEFT

RIGHT

NISSAN

SENTRA

FRONT

B12.N13

Year

1987-1992

NI1048
Outer Tie Rod End
(Ø13*Ø15.5/M12*1.25)

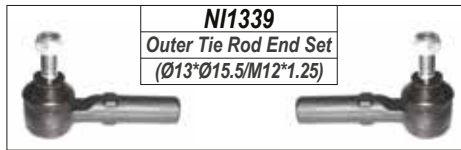

NI1339
Outer Tie Rod End Set
(Ø13*Ø15.5/M12*1.25)

NI1429
Rack End
(16*1.0/12*1.25/260)

NI1048
Outer Tie Rod End
(Ø13*Ø15.5/M12*1.25)

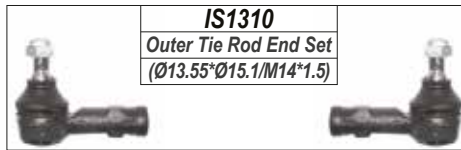

IS1310
Outer Tie Rod End Set
(Ø13.55*Ø15.1/M14*1.5)

IS1011
Outer Tie Rod End
(Ø13.55*Ø15.1/M14*1.5)



NI1430
Rack End
(14*1.5/14*1.5/286)

IS1011
Outer Tie Rod End
(Ø13.55*Ø15.1/M14*1.5)



NI1518
Link Stabilizer
L=84.5



NI1926
Lower Ball Joint
(Ø14.75)



NI2130
Lower Control Arm Bush



NI1926
Lower Ball Joint
(Ø14.75)



NI2054
Lower Control Arm

NI2055
Lower Control Arm

NI2131
Lower Control Arm Bush

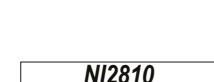

NI2810
Stabilizer Bar Bush



LEFT

RIGHT

NISSAN

SENTRA-SABRE

FRONT

B13.N15

Year

1992-1997

NI1048
Outer Tie Rod End
(Ø13*Ø15.5/M12*1.25)

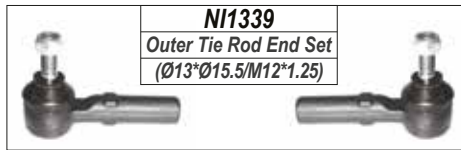

NI1339
Outer Tie Rod End Set
(Ø13*Ø15.5/M12*1.25)

NI1411
Rack End
(16*1.0/12*1.25/271)

NI1048
Outer Tie Rod End
(Ø13*Ø15.5/M12*1.25)



NI1518
Link Stabilizer
L=84.5



NI1922
Lower Ball Joint
(Ø14.83)



NI2130
Lower Control Arm Bush



NI1922
Lower Ball Joint
(Ø14.83)



NI2056
Lower Control Arm

NI2057
Lower Control Arm

NI2825
Shock Mounting



NI2116
Lower Control Arm Bush

NI2825
Shock Mounting



SENTRA-SABRE

REAR

NI1541
Link Stabilizer
L=175



LEFT

RIGHT

NISSAN

SENTRA-SABRE

FRONT

B14

Year

1997-2002

NI1048
Outer Tie Rod End
(Ø13*Ø15.5/M12*1.25)



NI1429
Rack End
(16*1.0/12*1.25/271)



NI1048
Outer Tie Rod End
(Ø13*Ø15.5/M12*1.25)

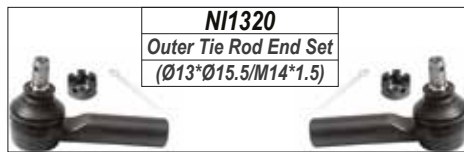

NI1320
Outer Tie Rod End Set
(Ø13*Ø15.5/M14*1.5)

NI1028
Outer Tie Rod End
(Ø13*Ø15.5/M14*1.5)



NI1412
Rack End
(16*1.0/14*1.5/286)



NI1028
Outer Tie Rod End
(Ø13*Ø15.5/M14*1.5)



NI1518
Link Stabilizer
L=84.5



NI1922
Lower Ball Joint
(Ø14.83)



NI2130
Lower Control Arm Bush



NI1922
Lower Ball Joint
(Ø14.83)



NI2056
Lower Control Arm

NI2057
Lower Control Arm

NI2825
Shock Mounting



NI2825
Shock Mounting



NI2116
Lower Control Arm Bush



SENTRA-SABRE

REAR

NI1541
Link Stabilizer
L=175



LEFT

RIGHT

NISSAN

SENTRA

FRONT

ALL MODELS

Year

2013-

NI1014
Outer Tie Rod End
(Ø11.9*Ø14.7/M12*1.25)



NI1323
Outer Tie Rod End Set
(Ø11.9*Ø14.7/M12*1.25)

NI1015
Outer Tie Rod End
(Ø11.9*Ø14.7/M12*1.25)



NI1431
Rack End
(16*1.0/12*1.25/217)



NI1542
Link Stabilizer
L=285



NI2142
Lower Control Arm Bush



NI1933
Lower Ball Joint
(Ø18)



NI1933
Lower Ball Joint
(Ø18)



NI2058
Lower Control Arm



NI2059
Lower Control Arm

NI2143
Lower Control Arm Bush



NI2826
Shock Mounting



NI2827
Shock Mounting



LEFT

RIGHT

NISSAN

SKYLINE

FRONT

Year

31

1987-

NI1023
Outer Tie Rod End
(Ø13.5*Ø15/M14*1.5)



NI1340
Outer Tie Rod End Set
(Ø13.5*Ø15/M14*1.5)

NI1418
Rack End
(14*1.5/14*1.5/138)



NI1023
Outer Tie Rod End
(Ø13.5*Ø15/M14*1.5)



NI2060
Lower Control Arm



NI2061
Lower Control Arm

LEFT

RIGHT

NISSAN

TERRANO

FRONT

R20

Year

2000-

NI2215

Center Rod



NI1341

Outer Tie Rod End Set
(Ø14.4*Ø16.4/M16*1.5)

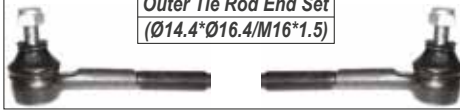

NI1342

Inner Tie Rod End Set
(Ø14.4*Ø16.4/M16*1.5)

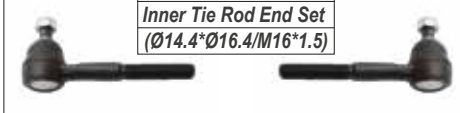

NI1049

Outer Tie Rod End
(Ø14.4*Ø16.4/M16*1.5)



NI1113

Inner Tie Rod End
(Ø14.4*Ø16.4/M16*1.5)

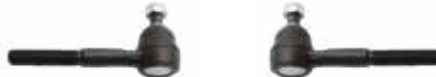

NI1049

Outer Tie Rod End
(Ø14.4*Ø16.4/M16*1.5)



NI1543

Link Stabilizer
L=89



NI1613

Upper Ball Joint
(Ø16)



NI2145

Lower Control Arm Bush



NI1613

Upper Ball Joint
(Ø16)



NI1712

Upper Control Arm



NI1713

Upper Control Arm



NI1913

Lower Ball Joint
(Ø19.6)



NI1913

Lower Ball Joint
(Ø19.6)



NI2012

Lower Control Arm



NI2013

Lower Control Arm



LEFT

RIGHT

NISSAN

TIIDA / LIVINA
GRAND LIVINA

FRONT

ALL MODELS

Year

2006-

NI1038
Outer Tie Rod End
(Ø11.85*Ø14.7/M12*1.25)



NI1331
Outer Tie Rod End Set
(Ø11.85*Ø14.7/M12*1.25)

NI1424
Rack End
(14*1.5/12*1.25/200)

NI1039
Outer Tie Rod End
(Ø11.85*Ø14.7/M12*1.25)



NI1522
Link Stabilizer
L=250



NI2117
Lower Control Arm Bush



NI1931
Lower Ball Joint
(Ø18)



NI1931
Lower Ball Joint
(Ø18)



NI2040
Lower Control Arm



NI2041
Lower Control Arm



NI2118
Lower Control Arm Bush



NI2814
Shock Mounting



NI2815
Shock Mounting



LEFT

RIGHT

NISSAN

X-TRAIL

FRONT

T30

Year

2001-2008

NI1050
Outer Tie Rod End
(Ø14.8*Ø18.8/M14*1.5)

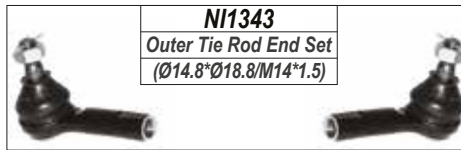

NI1343
Outer Tie Rod End Set
(Ø14.8*Ø18.8/M14*1.5)

NI1050
Outer Tie Rod End
(Ø14.8*Ø18.8/M14*1.5)



NI1412
Rack End
(16*1.0/14*1.5/286)



NI1544 / NI1545
Link Stabilizer
L=65



NI2132
Lower Control Arm Bush



NI2062
Lower Control Arm

NI2063
Lower Control Arm

NI2817
Shock Mounting



NI2817
Shock Mounting



NI2133
Lower Control Arm Bush



X-TRAIL

REAR

NI1546
Link Stabilizer
L=115



LEFT

RIGHT

NISSAN

X-TRAIL

FRONT

T31

Year

2007-2014

NI1044
Outer Tie Rod End
(Ø11.8*Ø14.7/M14*1.5)



NI1337
Outer Tie Rod End Set
(Ø11.8*Ø14.7/M14*1.5)



NI1428
Rack End
(22*1.5/14*1.5/233)



NI1045
Outer Tie Rod End
(Ø11.8*Ø14.7/M14*1.5)



NI1544 / NI1545
Link Stabilizer
L=65



NI1527 / NI1528
Link Stabilizer
L=300



NI1930
Lower Ball Joint
(Ø20)



NI2127
Lower Control Arm Bush



NI1930
Lower Ball Joint
(Ø20)



NI2050
Lower Control Arm



NI2051
Lower Control Arm

NI2822
Shock Mounting



NI2114
Lower Control Arm Bush



NI2823
Shock Mounting



X-TRAIL

REAR

NI2912
Bush



NI1539 / NI1540
Link Stabilizer
L=143.5



NI2912
Bush



NI2912
Bush



NI2610
Lateral Link



NI2912
Bush



NI2611
Lateral Link



NI2912
Bush



NI2612
Lateral Link



NI2912
Bush



NI2613
Lateral Link



NISSAN

X-TRAIL

FRONT

T32

Year

2014-

NI1051
Outer Tie Rod End
(Ø11.8*Ø14.6/M14*1.5)



NI1344
Outer Tie Rod End Set
(Ø11.8*Ø14.6/M14*1.5)

NI1432
Rack End
(16*1.5/14*1.5/224)



NI1052
Outer Tie Rod End
(Ø11.8*Ø14.6/M14*1.5)



NI2064
Lower Control Arm



NI2065
Lower Control Arm

LEFT

RIGHT

OPEL

ADAM

FRONT

ALL MODEL

Year

2014-

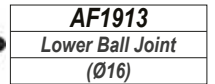
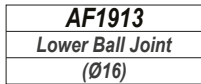
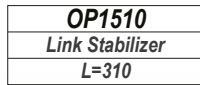
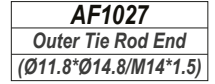
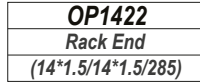
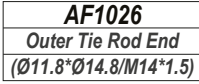
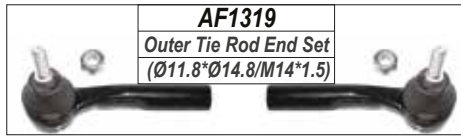

LEFT

RIGHT

OPEL

ASCONA

FRONT

Year

1981-1988

ALL

DA1010
Outer Tie Rod End
(Ø13*Ø15.3/M16*1.5)

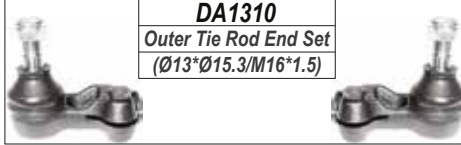

DA1310
Outer Tie Rod End Set
(Ø13*Ø15.3/M16*1.5)

DA2210
Rack End
(16*1.5/16*1.5/95)



DA1011
Outer Tie Rod End
(Ø13*Ø15.3/M16*1.5)



DA2211 / DA2212
Rack End



DA1510
Link Stabilizer
L=197.5



OP1914
Lower Ball Joint
(Ø13.3)



OP2012
Lower Control Arm



OP2013
Lower Control Arm



OP1914
Lower Ball Joint
(Ø13.3)

ASCONA

REAR

OP2910
Bush



LEFT

RIGHT

OPEL

**ASTRA/
KADETT/CALIBRA**

FRONT

Year

1991-1999

F

OP1016
Outer Tie Rod End
(Ø13*Ø15.5/M16*2)

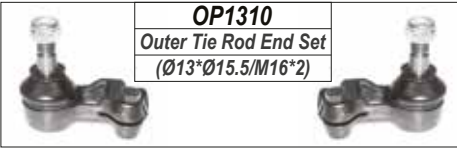

OP1310
Outer Tie Rod End Set
(Ø13*Ø15.5/M16*2)

OP1017
Outer Tie Rod End
(Ø13*Ø15.5/M16*2)



OP1423
Rack End
(16*2.0/16*2.0/100)



OP1424 / OP1425
Rack End



OP1511
Link Stabilizer
L=79.5 (22mm)

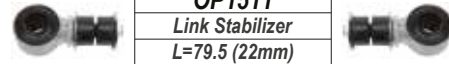

OP1512
Link Stabilizer
L=79.5 (18mm)

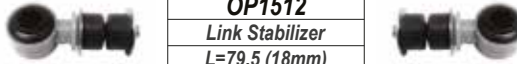

OP1513
Link Stabilizer
L=85

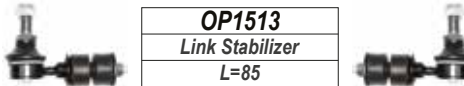

OP2111
Lower Control Arm Bush



OP1914
Lower Ball Joint
(Ø13.3)



OP1914
Lower Ball Joint
(Ø13.3)



OP2014
Lower Control Arm



OP2015
Lower Control Arm



OP2112
Lower Control Arm Bush

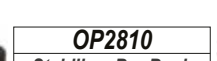

OP2818
Shock Mounting



OP2810
Stabilizer Bar Bush
ID:18

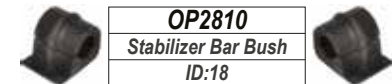

OP2818
Shock Mounting



OP2811
Stabilizer Bar Bush
ID:22

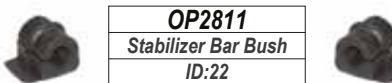

DA2910
Bush



**ASTRA/
KADETT/CALIBRA**

REAR

LEFT

RIGHT

OPEL

ASTRA

FRONT

Year

1999-2004

G

OP1018
Outer Tie Rod End
(Ø13.3*Ø17.2/M14*1.5)



OP1311
Outer Tie Rod End Set
(Ø13.3*Ø17.2/M14*1.5)



OP1018
Outer Tie Rod End
(Ø13.3*Ø17.2/M14*1.5)



OP1426
Rack End
(18*1.5/14*1.5/280)



OP1514
Link Stabilizer
L=300



OP1515
Link Stabilizer
L=300 Plastic



OP2114
Lower Control Arm Bush



OP1915
Lower Ball Joint
(Ø18)



OP1915
Lower Ball Joint
(Ø18)



OP2016
Lower Control Arm

OP2017
Lower Control Arm

OP2822
Shock Mounting



OP2822
Shock Mounting



OP2113
Lower Control Arm Bush

OP2812
Stabilizer Bar Bush
ID:18

OP2819
Shock Mounting



OP2819
Shock Mounting



ASTRA

REAR

DA2911
Bush



LEFT

RIGHT

OPEL

ASTRA

FRONT

H

Year

2004-2009

OP1019
Outer Tie Rod End
(Ø13.4*Ø17/M14*1.5)

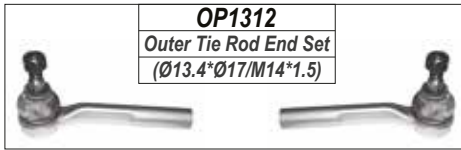

OP1312
Outer Tie Rod End Set
(Ø13.4*Ø17/M14*1.5)

OP1020
Outer Tie Rod End
(Ø13.4*Ø17/M14*1.5)



OP1410
Rack End
(18*1.5/14*1.5/283)



OP1411
Rack End
(16*1.5/14*1.5/277)



OP1427
Rack End
(18*1.5/14*1.5/278)



OP1428
Rack End
(16*1.5/14*1.5/274)



OP1516
Link Stabilizer
L=300



OP1515
Link Stabilizer
L=300 Plastic

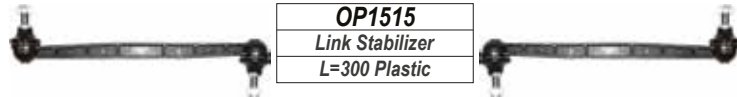

OP2114
Lower Control Arm Bush

OP1915
Lower Ball Joint
(Ø18)



OP1915
Lower Ball Joint
(Ø18)



OP2016
Lower Control Arm

OP2017
Lower Control Arm

OP2820
Shock Mounting



OP2115
Lower Control Arm Bush



OP2810
Stabilizer Bar Bush
ID:18



OP2811
Stabilizer Bar Bush
ID:22



OP2820
Shock Mounting



LEFT

RIGHT

OPEL

ASTRA

FRONT

J

Year

2010-2016

OP1010
Outer Tie Rod End
(Ø13.2*Ø18.1/M16*1.5)

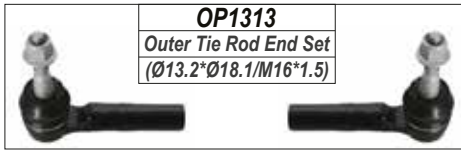

OP1313
Outer Tie Rod End Set
(Ø13.2*Ø18.1/M16*1.5)

OP1010
Outer Tie Rod End
(Ø13.2*Ø18.1/M16*1.5)



OP1412
Rack End
(16*1.5/16*1.5/299)



OP1413
Rack End
(16*1.5/16*1.5/290)



CH1414
Rack End
(16*1.5 /16*1.5/284)



CH1516
Link Stabilizer
L=304



OP1517
Link Stabilizer
L=304

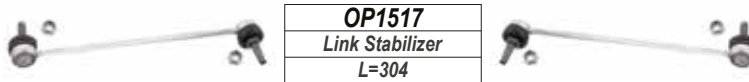

CH2116
Lower Control Arm Bush



CH2018
Lower Control Arm

CH2019
Lower Control Arm

OP2814
Stabilizer Bar Bush



OP2814
Stabilizer Bar Bush



CH2117
Lower Control Arm Bush

CH2116
Lower Control Arm Bush



CH2016
Lower Control Arm
Aliminium

CH2017
Lower Control Arm
Aliminium

CH2812
Shock Mounting



CH2812
Shock Mounting



CH2117
Lower Control Arm Bush

LEFT

RIGHT

OPEL

ASTRA

FRONT

K

Year

2016-

OP1021
Outer Tie Rod End
(Ø13.5*Ø18/M14*1.5)

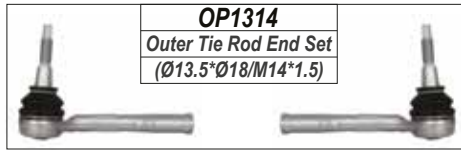

OP1314
Outer Tie Rod End Set
(Ø13.5*Ø18/M14*1.5)

OP1429
Rack End
(14*1.5/14*1.5/262.5)



OP1022
Outer Tie Rod End
(Ø13.5*Ø18/M14*1.5)



OP1518 / OP1519
Link Stabilizer
L=306



OP2116
Lower Control Arm Bush



OP1916
Lower Ball Joint
(Ø12.5)



OP2018
Lower Control Arm

OP2019
Lower Control Arm

OP1916
Lower Ball Joint
(Ø12.5)



OP2117
Lower Control Arm Bush



LEFT

RIGHT

OPEL

CORSA (LITE)

FRONT

Year

1996-2009

B

OP1011
Outer Tie Rod End
(Ø10.6*Ø14/M12*1.5)

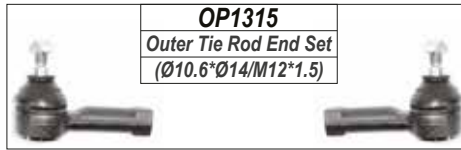

OP1315
Outer Tie Rod End Set
(Ø10.6*Ø14/M12*1.5)

OP1414
Rack End
(14*1.5/12*1.5/302)

OP1011
Outer Tie Rod End
(Ø10.6*Ø14/M12*1.5)



OP1012
Outer Tie Rod End
(Ø10.6*Ø13.6/M12*1.25)

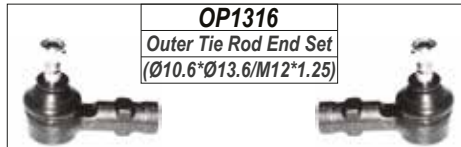

OP1316
Outer Tie Rod End Set
(Ø10.6*Ø13.6/M12*1.25)

OP1415
Rack End
(14*1.5/12*1.5/282)

OP1012
Outer Tie Rod End
(Ø10.6*Ø13.6/M12*1.25)



OP1910
Lower Ball Joint
(Ø15)



CH2122
Lower Control Arm Bush



OP2020
Lower Control Arm

OP2021
Lower Control Arm

OP1910
Lower Ball Joint
(Ø15)



OP1911
Lower Ball Joint
(Ø15)



CH2122
Lower Control Arm Bush



OP2022
Lower Control Arm

OP2023
Lower Control Arm

OP1911
Lower Ball Joint
(Ø15)



OP2821
Shock Mounting



OP2912
Bush



OP2815
Stabilizer Bar Bush



OP2821
Shock Mounting



CORSA (LITE)

REAR

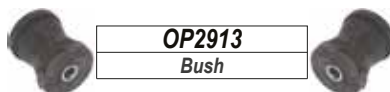

OP2913
Bush

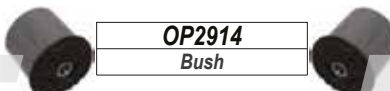

OP2914
Bush

LEFT

RIGHT

OPEL

CORSA (LDV)

FRONT

Year

1996-2004

B

OP1011
Outer Tie Rod End
(Ø10.6*Ø14/M12*1.5)



OP1315
Outer Tie Rod End Set
(Ø10.6*Ø14/M12*1.5)

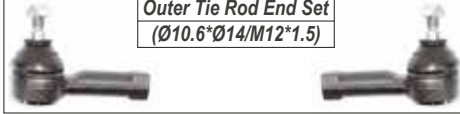

OP1011
Outer Tie Rod End
(Ø10.6*Ø14/M12*1.5)



OP1414
Rack End
(14*1.5/12*1.5/302)



OP1316
Outer Tie Rod End Set
(Ø10.6*Ø13.6/M12*1.25)

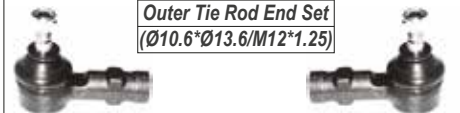

OP1012
Outer Tie Rod End
(Ø10.6*Ø13.6/M12*1.25)



OP1012
Outer Tie Rod End
(Ø10.6*Ø13.6/M12*1.25)



OP1416
Rack End
(14*1.5/12*1.5/314)

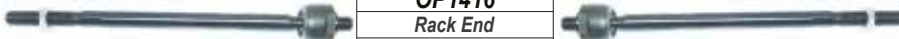

OP1417
Rack End
(14*1.5/12*1.5/309)



OP1418
Rack End
(14*1.5/12*1.5/286)



OP1910
Lower Ball Joint
(Ø15)



CH2122
Lower Control Arm Bush



OP1910
Lower Ball Joint
(Ø15)



OP2020
Lower Control Arm

OP2021
Lower Control Arm

OP1911
Lower Ball Joint
(Ø15)



CH2122
Lower Control Arm Bush

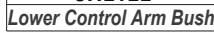

OP1911
Lower Ball Joint
(Ø15)



OP2022
Lower Control Arm

OP2023
Lower Control Arm

OP2821
Shock Mounting



OP2815
Stabilizer Bar Bush

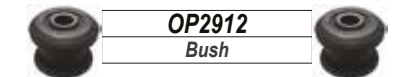

OP2821
Shock Mounting



OP2912
Bush

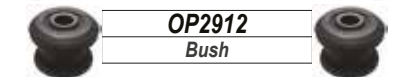

CORSA (LDV)

REAR

OP2913
Bush

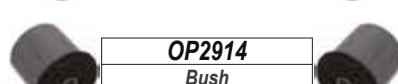

OP2914
Bush



LEFT

RIGHT

OPEL

CORSA / COMBO FRONT
CORSA LDV UTILITY

Year

2003-2010

C

OP1315
Outer Tie Rod End Set
(Ø10.6*Ø13.6/M12*1.25)

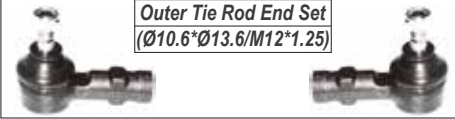

OP1011
Outer Tie Rod End
(Ø10.6*Ø14/M12*1.5)



OP1414
Rack End
(14*1.5/12*1.5/302)



OP1011
Outer Tie Rod End
(Ø10.6*Ø14/M12*1.5)



OP1415
Rack End
(14*1.5/12*1.5/282)



OP1416
Rack End
(14*1.5/12*1.5/314)



OP1418
Rack End
(14*1.5/12*1.5/286)



OP2812
Stabilizer Bar Bush



OP2812
Stabilizer Bar Bush



OP2816
Stabilizer Bar Bush



OP2816
Stabilizer Bar Bush



OP1520
Link Stabilizer
L=243

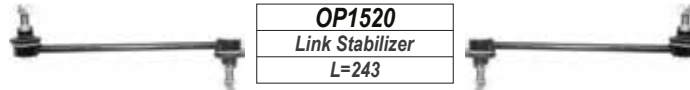

OP2118
Lower Control Arm Bush



OP2024
Lower Control Arm

OP2025
Lower Control Arm

OP2119
Lower Control Arm Bush

OP2914
Bush



OP1912
Lower Ball Joint
(Ø16)



OP1912
Lower Ball Joint
(Ø16)



OP2822
Shock Mounting



OP2822
Shock Mounting



OP2819
Shock Mounting



OP2819
Shock Mounting



CORSA

REAR

LEFT

RIGHT

OPEL

CORSA

FRONT

Year

2008-2015

D

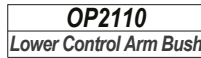
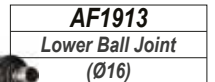
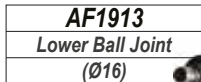
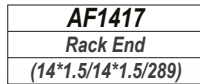
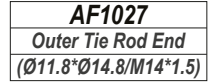
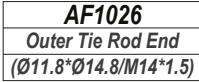
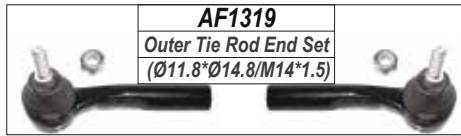

CORSA

REAR



LEFT

RIGHT

OPEL

CORSA

FRONT

E

Year

2015-

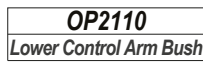
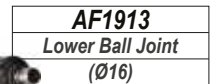
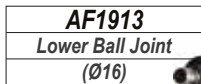
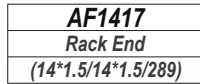
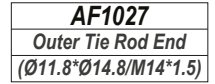
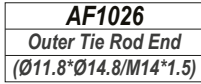
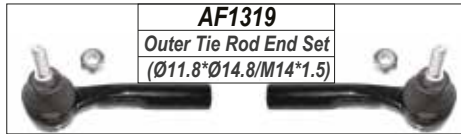

LEFT

RIGHT

OPEL

FRONTERA

FRONT

ALL MODELS

Year

1991-1998

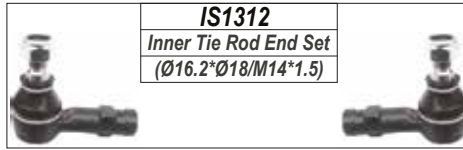

IS132
Inner Tie Rod End Set
(Ø16.2*Ø18/M14*1.5)

IS1012
Outer Tie Rod End
(Ø16.2*Ø18/M14*1.5)



IS1110
Inner Tie Rod End
(Ø16.2*Ø18/M14*1.5)



IS1110
Inner Tie Rod End
(Ø16.2*Ø18/M14*1.5)



IS1012
Outer Tie Rod End
(Ø16.2*Ø18/M14*1.5)



IS1210
Tie Rod End Assembly



IS1210
Tie Rod End Assembly

OP1521 / OP1522
Link Stabilizer
L=301



IS1610
Upper Ball Joint
(Ø17.6)



IS1610
Upper Ball Joint
(Ø17.6)



FT1610
Upper Ball Joint
(Ø17.56)



FT1610
Upper Ball Joint
(Ø17.56)



FT1911
Lower Ball Joint
(Ø20.6)



FT1911
Lower Ball Joint
(Ø20.6)



LEFT

RIGHT

OPEL

KADETT.MONZA

FRONT

Year

1980-1993

E

DA1010
Outer Tie Rod End
(Ø13*Ø15.3/M16*1.5)

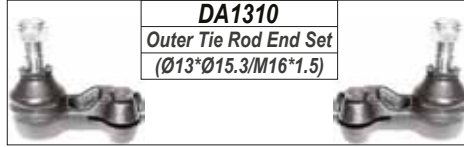

DA1310
Outer Tie Rod End Set
(Ø13*Ø15.3/M16*1.5)

DA2210
Rack End
(16*1.5/16*1.5/95)



DA1011
Outer Tie Rod End
(Ø13*Ø15.3/M16*1.5)



DA2211 / DA2212
Rack End



DA1510
Link Stabilizer
L=197.5



DA1914
Lower Ball Joint
(Ø13.3)



DA1914
Lower Ball Joint
(Ø13.3)



DA2111
Lower Control Arm Bush



DA2010
Lower Control Arm

DA2011
Lower Control Arm

DA2110
Lower Control Arm Bush

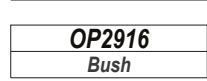

DA2810
Shock Mounting



OP2916
Bush



DA2810
Shock Mounting



KADETT.MONZA

REAR

OP1523
Link Stabilizer
L=50



DA2910
Bush



LEFT

RIGHT

OPEL

MERIVA

FRONT

A

Year

2003-2010

OP1013
Outer Tie Rod End
(Ø10.7*Ø13.2/M14*1.5)

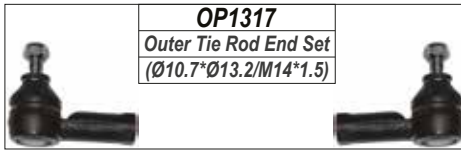

OP1317
Outer Tie Rod End Set
(Ø10.7*Ø13.2/M14*1.5)

OP1419
Rack End
(14*1.5/14*1.5/316)

OP1013
Outer Tie Rod End
(Ø10.7*Ø13.2/M14*1.5)

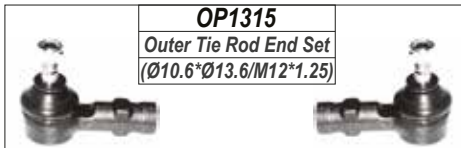

OP1315
Outer Tie Rod End Set
(Ø10.6*Ø13.6/M12*1.25)

OP1011
Outer Tie Rod End
(Ø10.6*Ø14/M12*1.5)



OP1414
Rack End
(14*1.5/12*1.5/302)

OP1011
Outer Tie Rod End
(Ø10.6*Ø14/M12*1.5)



OP1520
Link Stabilizer
L=243



OP2118
Lower Control Arm Bush



OP1917
Lower Ball Joint
(Ø16)



OP1918
Lower Ball Joint
(Ø16)



OP2822
Shock Mounting



OP2026
Lower Control Arm



OP2027
Lower Control Arm



OP2822
Shock Mounting



OP2119
Lower Control Arm Bush



OP2819
Shock Mounting



OP2812
Stabilizer Bar Bush



OP2819
Shock Mounting



OP2816
Stabilizer Bar Bush



MERIVA

REAR

OP2911
Bush



OP2917
Bush



LEFT

RIGHT

OPEL

MERIVA

FRONT

Year

2012-

B

OP1023
Outer Tie Rod End
(Ø13.3*Ø17.3/M14*1.5)

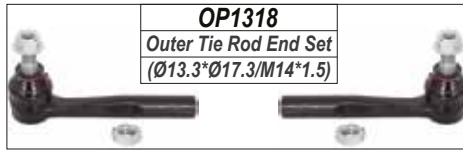

OP1318
Outer Tie Rod End Set
(Ø13.3*Ø17.3/M14*1.5)

OP1024
Outer Tie Rod End
(Ø13.3*Ø17.3/M14*1.5)



OP1420
Rack End
(18*1.5/14*1.5/275)



OP1524
Link Stabilizer
L=304



OP2114
Lower Control Arm Bush

OP1915
Lower Ball Joint
(Ø18)



OP2016
Lower Control Arm

OP2017
Lower Control Arm

OP2115
Lower Control Arm Bush

OP1915
Lower Ball Joint
(Ø18)



LEFT

RIGHT

OPEL

MOKKA

FRONT

ALL MODELS

Year

2013-

OP1014
Outer Tie Rod End
(Ø13*Ø16.2/M14*1.5)

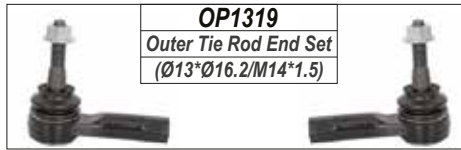

OP1319
Outer Tie Rod End Set
(Ø13*Ø16.2/M14*1.5)

OP1421
Rack End
(14*1.5/14*1.5/350)

OP1014
Outer Tie Rod End
(Ø13*Ø16.2/M14*1.5)



OP1431
Rack End
(14*1.5/14*1.5/350)



OP1525 / OP1526
Link Stabilizer
L=285



CH1912
Lower Ball Joint
(Ø18.17)



OP2120
Lower Control Arm Bush

CH1912
Lower Ball Joint
(Ø18.17)



OP2028
Lower Control Arm

OP2029
Lower Control Arm



CH2812
Shock Mounting



OP2121
Lower Control Arm Bush



CH2812
Shock Mounting



LEFT

RIGHT

OPEL

MOVANO

FRONT

ALL MODELS

Year

1998-

NI1012
Outer Tie Rod End
(Ø16.4*Ø20.2/M16*1.5)



NI1322
Outer Tie Rod End Set
(Ø16.4*Ø20.2/M16*1.5)

NI1013
Outer Tie Rod End
(Ø16.4*Ø20.2/M16*1.5)



NI1413
Rack End
(14*1.5/16*1.5/174)



NI1515 / NI1516
Link Stabilizer
L=127



NI1610
Upper Ball Joint
(Ø16.1)



NI1610
Upper Ball Joint
(Ø16.1)



NI2112
Lower Control Arm Bush

NI1915
Lower Ball Joint
(Ø22)



NI2018
Lower Control Arm

NI2019
Lower Control Arm

NI1915
Lower Ball Joint
(Ø22)



NI2113
Lower Control Arm Bush

NI1916
Lower Ball Joint
(Ø24)



NI2020
Lower Control Arm

NI2021
Lower Control Arm

NI1916
Lower Ball Joint
(Ø24)



NI2113
Lower Control Arm Bush

MOVANO

REAR

NI2919
Bush



LEFT

RIGHT

OPEL

RECORD. SENATOR FRONT

Year

E

1982-1991

OP2210

Center Rod



OP1320

Outer Tie Rod End Set
(Ø13.3*Ø15.3/M14*1.5)

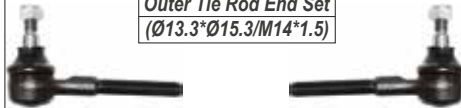

OP1321

Inner Tie Rod End Set
(Ø13.3*Ø15.3/M14*1.5)

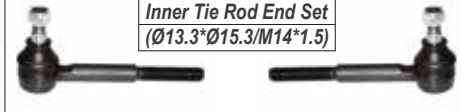

OP1015

Outer Tie Rod End
(Ø13.3*Ø15.3/M14*1.5)



OP1110

Inner Tie Rod End
(Ø13.3*Ø15.3/M14*1.5)



OP1015

Outer Tie Rod End
(Ø13.3*Ø15.3/M14*1.5)



OP1527

Link Stabilizer
L=195



OP1913

Lower Ball Joint
(Ø14)



OP1913

Lower Ball Joint
(Ø14)



MOVANO

REAR

OP1523

Link Stabilizer
L=50



OP2918

Bush



LEFT

RIGHT

OPEL

TIGRA

FRONT

ALL MODELS

Year

2005-

OP1012
Outer Tie Rod End
(Ø10.6*Ø13.6/M12*1.25)

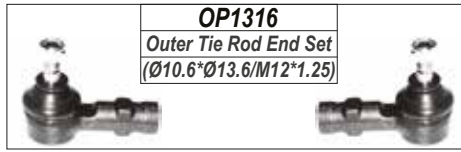

OP1316
Outer Tie Rod End Set
(Ø10.6*Ø13.6/M12*1.25)

OP1430
Rack End
(14*1.5/12*1.25/309)

OP1012
Outer Tie Rod End
(Ø10.6*Ø13.6/M12*1.25)



OP2118
Lower Control Arm Bush

OP1912
Lower Ball Joint
(Ø16)

OP1912
Lower Ball Joint
(Ø16)

OP2024
Lower Control Arm

OP2025
Lower Control Arm

OP2119
Lower Control Arm Bush

LEFT

RIGHT

OPEL

VIVARO

FRONT

ALL MODELS

Year

2001-

NI1041
Outer Tie Rod End
(Ø12*Ø14.6/M14*1.5)



NI1335
Outer Tie Rod End Set
(Ø12*Ø14.6/M14*1.5)

NI1426
Rack End
(12*1.0/14*1.5/263)



NI1042
Outer Tie Rod End
(Ø12*Ø14.6/M14*1.5)



NI1536
Link Stabilizer
L=279



NI1921
Lower Ball Joint
(Ø17.84)



NI2123
Lower Control Arm Bush



NI2044
Lower Control Arm

NI2045
Lower Control Arm

NI1921
Lower Ball Joint
(Ø17.84)



OP2122
Lower Control Arm Bush

NI2123
Lower Control Arm Bush

OP1919
Lower Ball Joint
(Ø17.84)



OP2030
Lower Control Arm

OP2031
Lower Control Arm

OP1919
Lower Ball Joint
(Ø17.84)



NI2824
Shock Mounting



OP2122
Lower Control Arm Bush

NI2824
Shock Mounting



LEFT

RIGHT

OPEL

ZAFIRA

FRONT

A

Year

2001-2006

OP1018
Outer Tie Rod End
(Ø13.3*Ø17.2/M14*1.5)



OP1311
Outer Tie Rod End Set
(Ø13.3*Ø17.2/M14*1.5)



OP1018
Outer Tie Rod End
(Ø13.3*Ø17.2/M14*1.5)



OP1426
Rack End
(18*1.5/14*1.5/280)



OP1514
Link Stabilizer
L=300



OP1515
Link Stabilizer
L=300 Plastic



OP2114
Lower Control Arm Bush



OP1915
Lower Ball Joint
(Ø18)



OP1915
Lower Ball Joint
(Ø18)



OP2016
Lower Control Arm

OP2017
Lower Control Arm

OP2822
Shock Mounting



OP2822
Shock Mounting



OP2113
Lower Control Arm Bush

OP2812
Stabilizer Bar Bush
ID:18

OP2819
Shock Mounting



OP2819
Shock Mounting



ZAFIRA

REAR

DA2911
Bush



LEFT

RIGHT

OPEL

ZAFIRA

FRONT

Year

2005-2012

B

OP1312
Outer Tie Rod End Set
(Ø13.4*Ø17/M14*1.5)

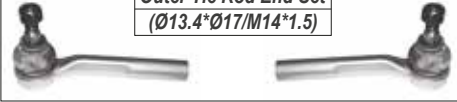

OP1019
Outer Tie Rod End
(Ø13.4*Ø17/M14*1.5)



OP1020
Outer Tie Rod End
(Ø13.4*Ø17/M14*1.5)



OP1410
Rack End
(18*1.5/14*1.5/283)



OP1411
Rack End
(16*1.5/14*1.5/277)



OP1516
Link Stabilizer
L=300



OP1515
Link Stabilizer
L=300 Plastic



OP2114
Lower Control Arm Bush

OP1915
Lower Ball Joint
(Ø18)



OP2016
Lower Control Arm

OP2017
Lower Control Arm

OP1915
Lower Ball Joint
(Ø18)



OP2115
Lower Control Arm Bush



OP2820
Shock Mounting



OP2820
Shock Mounting



LEFT

RIGHT

PEUGEOT

1007

FRONT

ALL MODELS

Year

2005-

CI1015
Outer Tie Rod End
(Ø12.1*Ø15.1/M14*1.5)

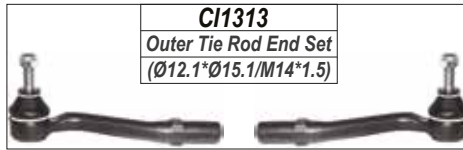

CI1313
Outer Tie Rod End Set
(Ø12.1*Ø15.1/M14*1.5)

CI1016
Outer Tie Rod End
(Ø12.1*Ø15.1/M14*1.5)



CI1413
Rack End
(12*1.0/14*1.5/239)



CI1513
Link Stabilizer
L=335



CI2116
Lower Control Arm Bush



CI1914
Lower Ball Joint
(Ø18)



CI2016
Lower Control Arm

CI2017
Lower Control Arm

CI1914
Lower Ball Joint
(Ø18)



CI2117
Lower Control Arm Bush



CI2813
Shock Mounting(Pin Mid)



CI2813
Shock Mounting(Pin Mid)



LEFT

RIGHT

PEUGEOT

107

FRONT

ALL MODELS

Year

2005-



LEFT

RIGHT

PEUGEOT

2008

FRONT

ALL MODELS

Year

2012-

PE1023
Outer Tie Rod End
(Ø12.1*Ø15/M14*1.5)



PE1310
Outer Tie Rod End Set
(Ø12.1*Ø15/M14*1.5)

PE1410
Rack End
(12*1.0/14*1.5/225)



PE1024
Outer Tie Rod End
(Ø12.1*Ø15/M14*1.5)



PE1510 / PE1511
Link Stabilizer
L=330



CI2118
Lower Control Arm Bush



PE1910
Lower Ball Joint
(Ø18)



PE1910
Lower Ball Joint
(Ø18)



PE2010
Lower Control Arm

PE2011
Lower Control Arm

CI2119
Lower Control Arm Bush



LEFT

RIGHT

PEUGEOT

206

FRONT

ALL MODELS

Year

1998-2009

CI1019
Outer Tie Rod End
(Ø12.1*Ø15.85/M14*1.5)



CI1315
Outer Tie Rod End Set
(Ø12.1*Ø15.85/M14*1.5)

PE1411
Rack End
(14*1.5/14*1.5/297)

CI1020
Outer Tie Rod End
(Ø12.1*Ø15.85/M14*1.5)



CI1513
Link Stabilizer
L=335



PE2110
Lower Control Arm Bush



PE2012
Lower Control Arm



PE2013
Lower Control Arm



CI2113
Lower Control Arm Bush

PE2112
Lower Control Arm Bush



PE2014
Lower Control Arm
GTI Only



PE2015
Lower Control Arm
GTI Only



PE2810
Shock Mounting



PE2811
Shock Mounting



PE2110
Lower Control Arm Bush



LEFT

RIGHT

PEUGEOT

207

FRONT

ALL MODELS

Year

2006-2012

PE1010
Outer Tie Rod End
(Ø12.2*Ø15.2/M16*1.5)



PE1311
Outer Tie Rod End Set
(Ø12.2*Ø15.2/M16*1.5)

PE1412
Rack End
(12*1.0/16*1.5/211)



PE1011
Outer Tie Rod End
(Ø12.2*Ø15.2/M16*1.5)



PE1512 / PE1513
Link Stabilizer
L=330



PE2113
Lower Control Arm Bush



PE1911
Lower Ball Joint
(Ø18)



PE1911
Lower Ball Joint
(Ø18)



PE2016
Lower Control Arm



PE2017
Lower Control Arm



PE2114
Lower Control Arm Bush



CI2815
Shock Mounting



CI2815
Shock Mounting



LEFT

RIGHT

PEUGEOT

208

FRONT

ALL MODELS

Year

2012-

PE1023
Outer Tie Rod End
(Ø12.1*Ø15/M14*1.5)



PE1310
Outer Tie Rod End Set
(Ø12.1*Ø15/M14*1.5)

PE1410
Rack End
(12*1.0/14*1.5/225)

PE1024
Outer Tie Rod End
(Ø12.1*Ø15/M14*1.5)



PE1510 / PE1511
Link Stabilizer
L=330



CI2118
Lower Control Arm Bush



PE1910
Lower Ball Joint
(Ø18)



PE1910
Lower Ball Joint
(Ø18)



PE2010
Lower Control Arm



PE2011
Lower Control Arm



CI2119
Lower Control Arm Bush



CI2814
Shock Mounting



CI2814
Shock Mounting



LEFT

RIGHT

PEUGEOT

3008

FRONT

ALL MODELS

Year

2009-

CI1311

Outer Tie Rod End Set
(Ø12*Ø15/M14*1.5)



CI1011

Outer Tie Rod End
(Ø12*Ø15/M14*1.5)

CI1011

Outer Tie Rod End
(Ø12*Ø15/M14*1.5)

PE1415

Rack End
(14*1.5/14*1.5/277)



PE1514

Link Stabilizer
L=333



CI2112

Lower Control Arm Bush

CI1912

Lower Ball Joint
(Ø15.7)



CI1912

Lower Ball Joint
(Ø15.7)



CI2012

Lower Control Arm



CI2013

Lower Control Arm

CI2113

Lower Control Arm Bush



CI2816

Shock Mounting



CI2816

Shock Mounting



LEFT

RIGHT

PEUGEOT

306

FRONT

ALL MODELS

Year

1993-2003

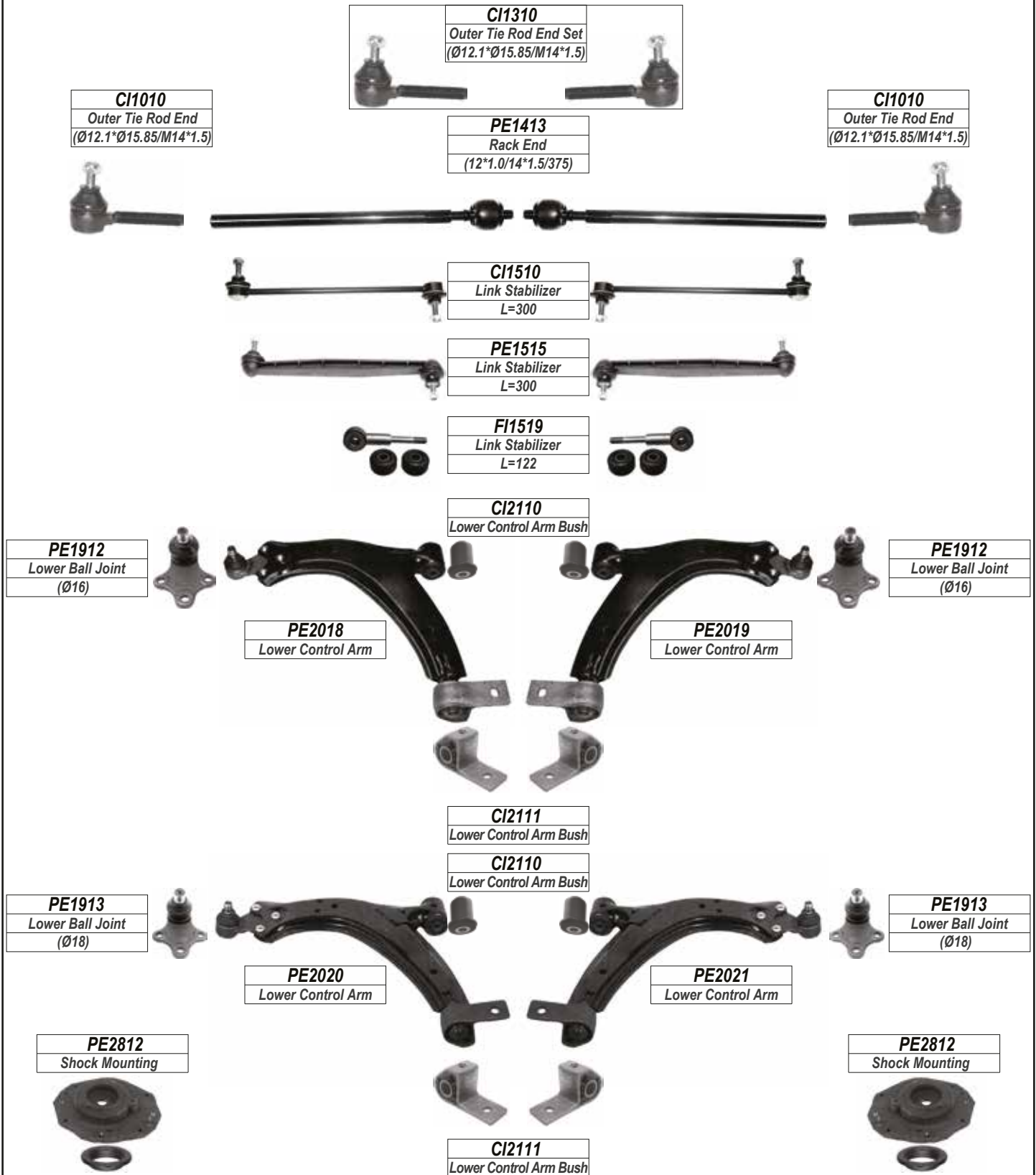

306

REAR

525

LEFT

RIGHT

PEUGEOT

307

FRONT

ALL MODELS

Year

2000-2008

CI1019
Outer Tie Rod End
(Ø12.1*Ø15.85/M14*1.5)



CI1315
Outer Tie Rod End Set
(Ø12.1*Ø15.85/M14*1.5)

CI1020
Outer Tie Rod End
(Ø12.1*Ø15.85/M14*1.5)

CI1415
Rack End
(14*1.5/14*1.5/319)



PE1414
Rack End
(14*1.5/14*1.5/342)



CI1515
Link Stabilizer
L=335



CI2112
Lower Control Arm Bush

CI1912
Lower Ball Joint
(Ø15.7)



CI2012
Lower Control Arm

CI2013
Lower Control Arm

CI1912
Lower Ball Joint
(Ø15.7)



CI2811
Shock Mounting



CI2113
Lower Control Arm Bush

CI2811
Shock Mounting



LEFT

RIGHT

PEUGEOT

308

FRONT

ALL MODELS

Year

2008-2013

CI1311

Outer Tie Rod End Set
(Ø12*Ø15/M14*1.5)



CI1011

Outer Tie Rod End
(Ø12*Ø15/M14*1.5)

CI1011

Outer Tie Rod End
(Ø12*Ø15/M14*1.5)

PE1415

Rack End
(14*1.5/14*1.5/277)



PE1514

Link Stabilizer
L=333



CI2112

Lower Control Arm Bush

CI1912

Lower Ball Joint
(Ø15.7)



CI1912

Lower Ball Joint
(Ø15.7)



CI2012

Lower Control Arm



CI2013

Lower Control Arm

CI2113

Lower Control Arm Bush



CI2816

Shock Mounting



CI2816

Shock Mounting



LEFT

RIGHT

PEUGEOT

308

FRONT

ALL MODELS

Year

2013-

CI1030
Outer Tie Rod End
(Ø14.4*Ø19/M14*1.5)

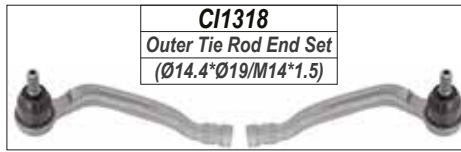

CI1318
Outer Tie Rod End Set
(Ø14.4*Ø19/M14*1.5)

CI1421
Rack End
(14*1.5/14*1.5/220)



CI1031
Outer Tie Rod End
(Ø14.4*Ø19/M14*1.5)



PE1516
Link Stabilizer
L=333



PE2116
Lower Control Arm Bush

PE1914
Lower Ball Joint
(Ø16.6)



PE2022
Lower Control Arm



PE2023
Lower Control Arm

PE1914
Lower Ball Joint
(Ø16.6)



PE2115
Lower Control Arm Bush



LEFT

RIGHT

PEUGEOT

405

FRONT

ALL MODELS

Year

1992-1997

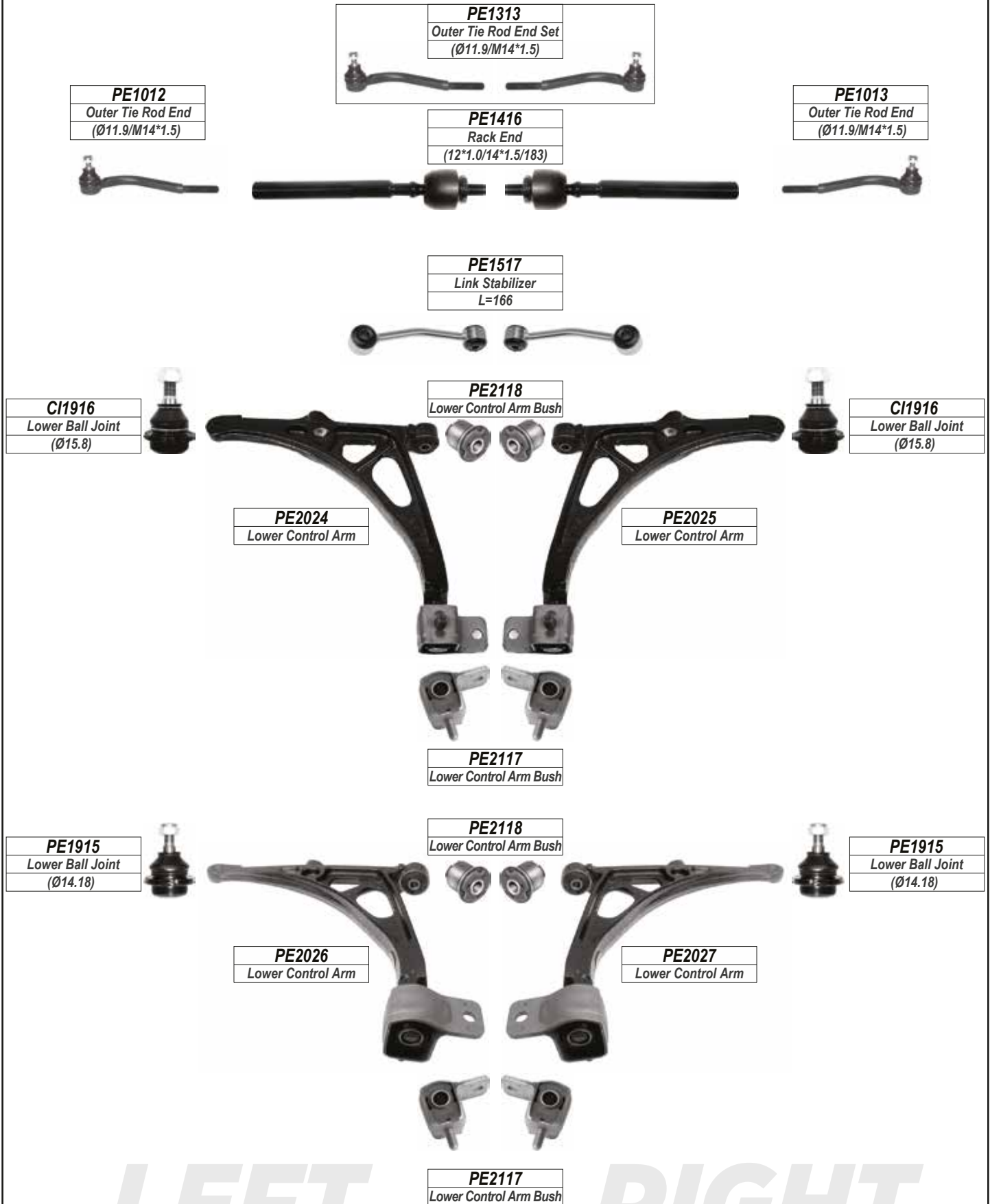

LEFT

RIGHT

PEUGEOT

406

FRONT

ALL MODELS

Year

1996-2005

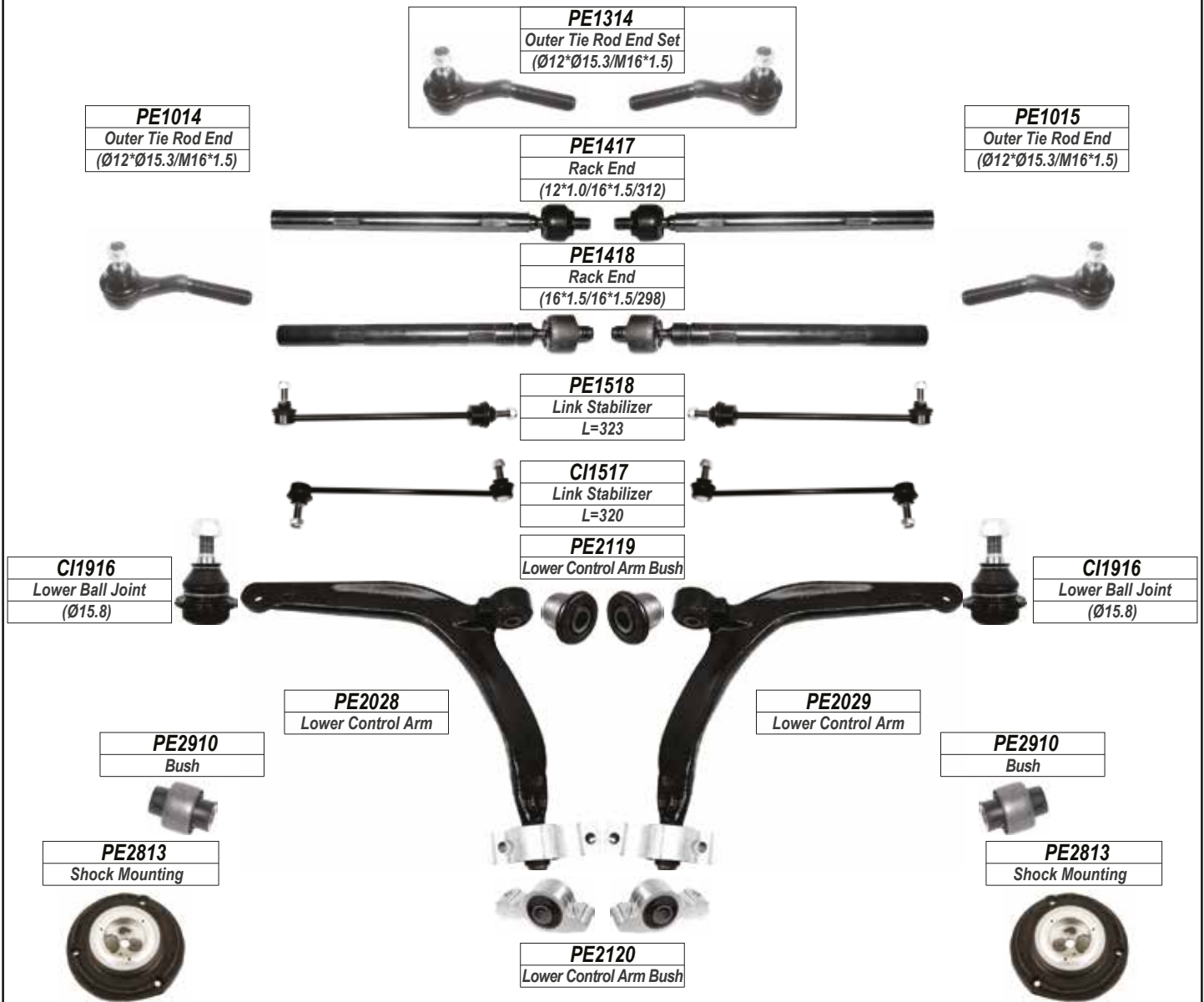

406

REAR



LEFT

RIGHT

PEUGEOT

407

FRONT

ALL MODELS

Year

2004-2009

PE1315
Outer Tie Rod End Set
(Ø12.1*Ø14.8/M14*1.5)



PE1316
Outer Tie Rod End Set
(Ø14.8*Ø17/M14*1.5)



PE1016
Outer Tie Rod End
(Ø12.1*Ø14.8/M14*1.5)



PE1018
Outer Tie Rod End
(Ø14.8*Ø17/M14*1.5)



PE1419
Rack End
(16*1.5/14*1.5/105)



PE1017
Outer Tie Rod End
(Ø12.1*Ø14.8/M14*1.5)



PE1019
Outer Tie Rod End
(Ø14.8*Ø17/M14*1.5)



CI1518 / CI1519
Link Stabilizer
L=200

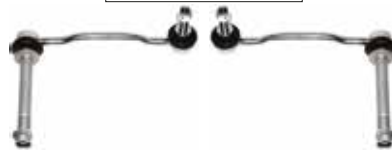

CI1610
Upper Ball Joint
(Ø18)



CI1610
Upper Ball Joint
(Ø18)



CI1917
Lower Ball Joint
(Ø15.8)



CI1917
Lower Ball Joint
(Ø15.8)



CI2124
Lower Control Arm Bush



PE2030
Lower Control Arm

PE2031
Lower Control Arm

PE2816
Shock Mounting



PE2816
Shock Mounting



PE2121
Lower Control Arm Bush

407

REAR

CI1520
Link Stabilizer
L=141



LEFT

RIGHT

PEUGEOT

5008

FRONT

ALL MODELS

Year

2009-

CI1011
Outer Tie Rod End
(Ø12*Ø15/M14*1.5)



CI1311
Outer Tie Rod End Set
(Ø12*Ø15/M14*1.5)

PE1415
Rack End
(14*1.5/14*1.5/277)



CI1012
Outer Tie Rod End
(Ø12*Ø15/M14*1.5)



PE1514
Link Stabilizer
L=333



CI1515
Link Stabilizer
L=335



CI2112
Lower Control Arm Bush



CI1912
Lower Ball Joint
(Ø15.7)



PE2032
Lower Control Arm

PE2033
Lower Control Arm

CI1912
Lower Ball Joint
(Ø15.7)



CI2113
Lower Control Arm Bush

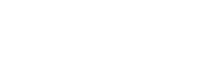

LEFT

RIGHT

PEUGEOT

508

FRONT

ALL MODELS

Year

2011-

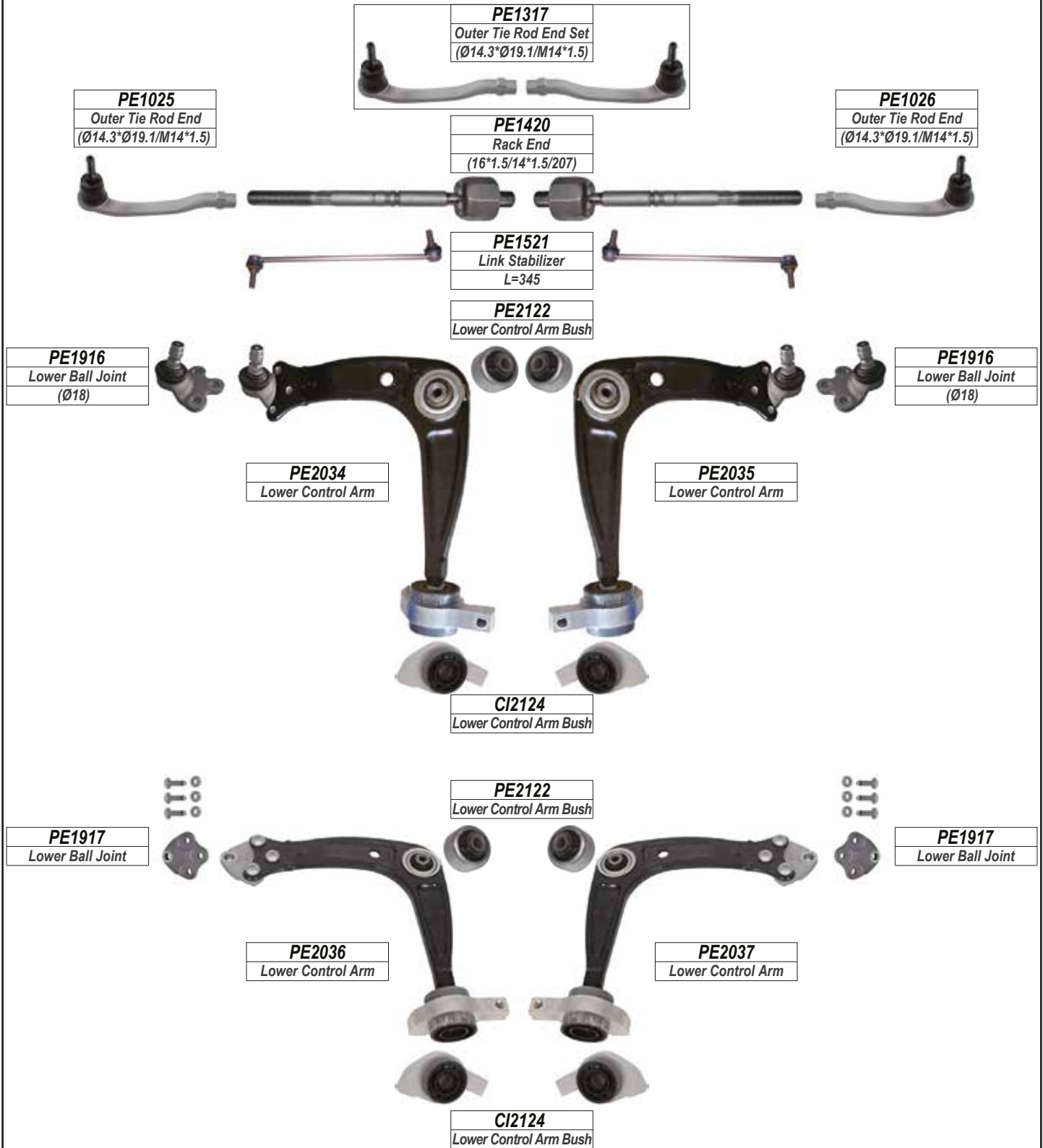

508

REAR

PE2914

Bush



LEFT

RIGHT

PEUGEOT

607

FRONT

ALL MODELS

Year

2001-2009

PE1020
Outer Tie Rod End
(Ø11.9*Ø15.7/M16*1.5)



PE1318
Outer Tie Rod End Set
(Ø11.9*Ø15.7/M16*1.5)

PE1421
Rack End
(16*1.5/16*1.5/294)

PE1021
Outer Tie Rod End
(Ø11.9*Ø15.7/M16*1.5)



PE1518
Link Stabilizer
L=323



PE1522
Link Stabilizer
L=300



CI1517
Link Stabilizer
L=320



PE2123
Lower Control Arm Bush

CI1916
Lower Ball Joint
(Ø15.8)



PE2038
Lower Control Arm

PE2039
Lower Control Arm

PE2124
Lower Control Arm Bush

CI1916
Lower Ball Joint
(Ø15.8)



607

REAR

PE1523 / PE1524
Link Stabilizer
L=86



LEFT

RIGHT

PEUGEOT

806

FRONT

ALL MODELS

Year

1997-2003

FI1022
Outer Tie Rod End
(Ø12.65*Ø14.5/M14*1.5)

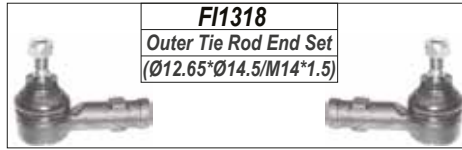

FI1318
Outer Tie Rod End Set
(Ø12.65*Ø14.5/M14*1.5)

FI1417
Rack End
(16*1.5/14*1.5/282)

FI1022
Outer Tie Rod End
(Ø12.65*Ø14.5/M14*1.5)



FI1519
Link Stabilizer
L=122



FI2132
Lower Control Arm Bush



FI2048
Lower Control Arm

FI2049
Lower Control Arm

FI2133 / FI2134
Lower Control Arm Bush



LEFT

RIGHT

PEUGEOT

807

FRONT

ALL MODELS

Year

2002-2007

F11023
Outer Tie Rod End
(Ø13.6*Ø15.5/M14*1.5)

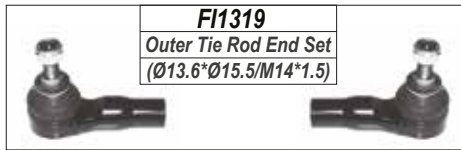

F11319
Outer Tie Rod End Set
(Ø13.6*Ø15.5/M14*1.5)

F11424
Rack End
(14*1.5/14*1.5/313)

F11023
Outer Tie Rod End
(Ø13.6*Ø15.5/M14*1.5)



F11520
Link Stabilizer
L=263



F12132
Lower Control Arm Bush



F12050
Lower Control Arm

F12051
Lower Control Arm

F12135 / F12136
Lower Control Arm Bush

LEFT

RIGHT

PEUGEOT

BOXER

FRONT

1.0Q/1.4Q/1.8Q

Year

1994-2002

PE1022
Outer Tie Rod End
(Ø14.5*Ø16.4/M16*1.5)

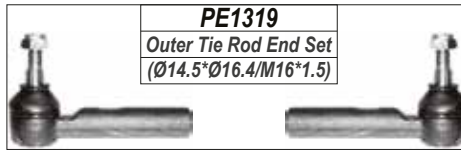

FI1415
Rack End
(16*1.5/16*1.5/317)

PE1022
Outer Tie Rod End
(Ø14.5*Ø16.4/M16*1.5)



FI1514
Link Stabilizer
L=134



FI2123
Lower Control Arm Bush

FI1914
Lower Ball Joint
(Ø16.65)



FI1914
Lower Ball Joint
(Ø16.65)

FI2028
Lower Control Arm

FI2029
Lower Control Arm

FI2124
Lower Control Arm Bush

FI2123
Lower Control Arm Bush

PE1918
Lower Ball Joint
(Ø19.5)



PE1918
Lower Ball Joint
(Ø19.5)

FI2030
Lower Control Arm

FI2031
Lower Control Arm

FI2124
Lower Control Arm Bush

LEFT

RIGHT

PEUGEOT

BOXER

FRONT

1.4Q/1.8Q

Year

2002-2006

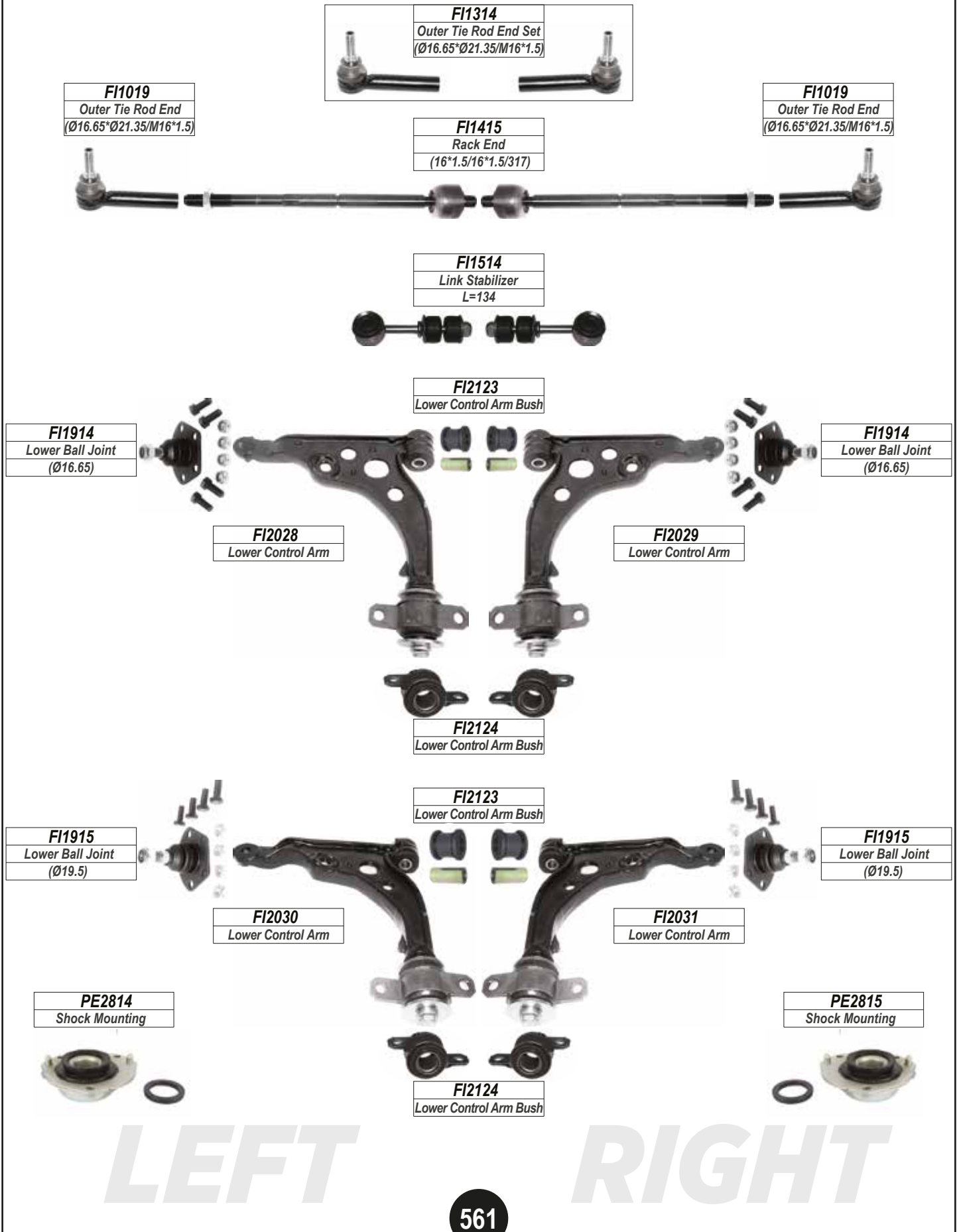

PEUGEOT

BOXER

FRONT

ALL MODELS

Year

2006-

CI1027
Outer Tie Rod End
(Ø16.65*Ø21.4/M16*1.5)

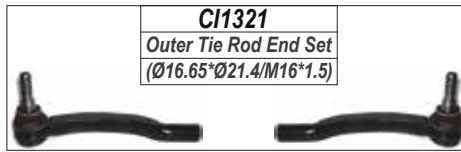

CI1321
Outer Tie Rod End Set
(Ø16.65*Ø21.4/M16*1.5)

CI1419
Rack End
(16*1.5/16*1.5/260)



CI1028
Outer Tie Rod End
(Ø16.65*Ø21.4/M16*1.5)



CI1521
Link Stabilizer
L=112



CI2126
Lower Control Arm Bush

CI1918
Lower Ball Joint
(Ø20.55)



CI1918
Lower Ball Joint
(Ø20.55)

CI2028
Lower Control Arm

CI2029
Lower Control Arm

CI2127
Lower Control Arm Bush

BOXER

REAR

CI1522
Link Stabilizer
L=100



LEFT

RIGHT

PEUGEOT

EXPERT

FRONT

ALL MODELS

Year

1995-

FI1022
Outer Tie Rod End
(Ø12.65*Ø14.5/M14*1.5)

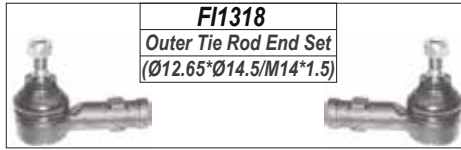

FI1318
Outer Tie Rod End Set
(Ø12.65*Ø14.5/M14*1.5)

FI1417
Rack End
(16*1.5/14*1.5/282)

FI1022
Outer Tie Rod End
(Ø12.65*Ø14.5/M14*1.5)



FI1519
Link Stabilizer
L=122



FI2132
Lower Control Arm Bush



FI2048
Lower Control Arm

FI2049
Lower Control Arm

FI2133 / FI2134
Lower Control Arm Bush

LEFT

RIGHT

PEUGEOT

EXPERT

FRONT

ALL MODELS

Year

2007-

FI1024
Outer Tie Rod End
(Ø14.5*Ø18.3/M14*1.5)

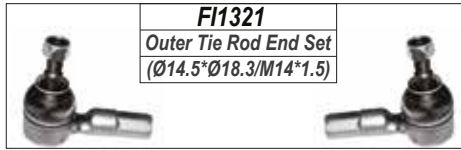

FI1321
Outer Tie Rod End Set
(Ø14.5*Ø18.3/M14*1.5)

PE1422
Rack End
(16*1.5/14*1.5/305)



FI1024
Outer Tie Rod End
(Ø14.5*Ø18.3/M14*1.5)



PE1525
Link Stabilizer
L=263



PE2125
Lower Control Arm Bush



PE2040
Lower Control Arm

PE2041
Lower Control Arm



FI2135 / FI2136
Lower Control Arm Bush

LEFT

RIGHT

PEUGEOT

PARTNER

FRONT

ALL MODELS

Year

1998-2008

CI1010
Outer Tie Rod End
(Ø12.1*Ø15.85/M14*1.5)

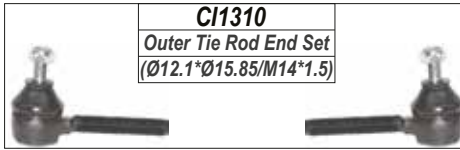

CI1310
Outer Tie Rod End Set
(Ø12.1*Ø15.85/M14*1.5)

CI1410
Rack End
(12*1.0 /14*1.5/335)

CI1010
Outer Tie Rod End
(Ø12.1*Ø15.85/M14*1.5)



CI1422
Rack End
(12*1.0/14*1.5/338)



CI1510
Link Stabilizer
L=300



CI1911
Lower Ball Joint
(Ø18)



CI2110
Lower Control Arm Bush



CI1911
Lower Ball Joint
(Ø18)



CI2010
Lower Control Arm



CI2011
Lower Control Arm



CI2111
Lower Control Arm Bush



CI2110
Lower Control Arm Bush



PE1920
Lower Ball Joint
(Ø16)



PE1920
Lower Ball Joint
(Ø16)



PE2042
Lower Control Arm



PE2043
Lower Control Arm



CI2111
Lower Control Arm Bush



LEFT

RIGHT

PEUGEOT

PARTNER

FRONT

ALL MODELS

Year

1998-2008

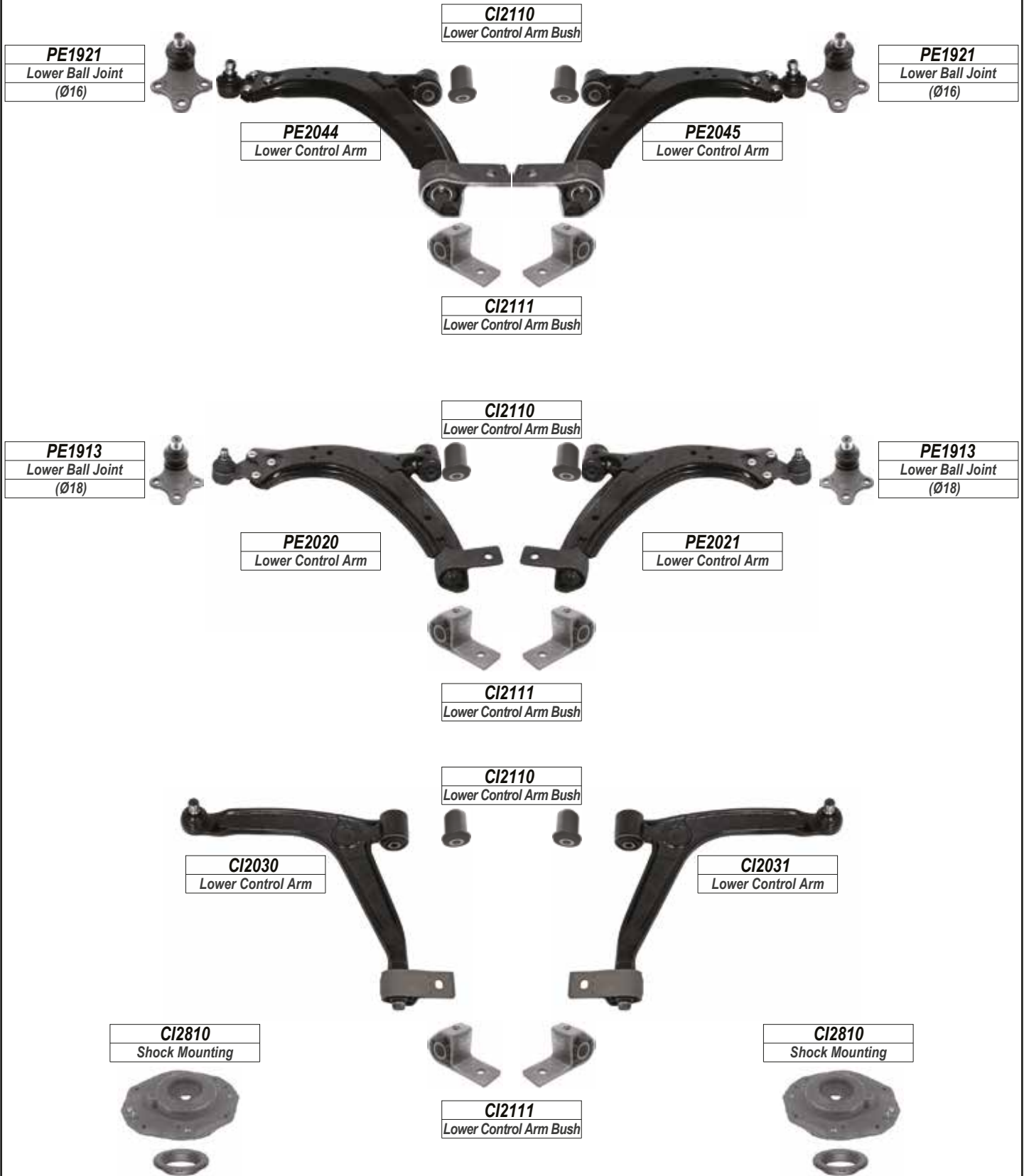

LEFT

RIGHT

PEUGEOT

PARTNER TEPE

FRONT

ALL MODELS

Year

2008-

CI1311

Outer Tie Rod End Set
(Ø12*Ø15/M14*1.5)



CI1011

Outer Tie Rod End
(Ø12*Ø15/M14*1.5)

CI1012

Outer Tie Rod End
(Ø12*Ø15/M14*1.5)

CI1411

Rack End
(14*1.5/14*1.5/262)

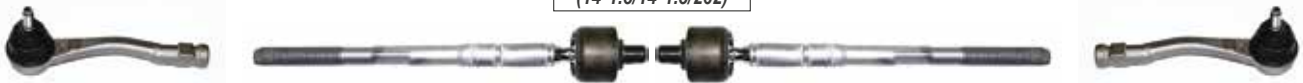

CI1511

Link Stabilizer
L=334



PE1526

Link Stabilizer
L=335 (Aluminium)



CI2112

Lower Control Arm Bush



CI1912

Lower Ball Joint
(Ø15.7)



CI1912

Lower Ball Joint
(Ø15.7)



CI2012

Lower Control Arm



CI2013

Lower Control Arm

CI2811

Shock Mounting



CI2113

Lower Control Arm Bush



CI2811

Shock Mounting



LEFT

RIGHT

PORSCHE

CAYENNE

FRONT

ALL MODELS

Year

2002-2010

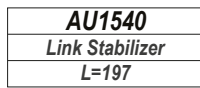
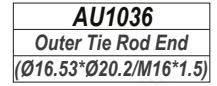
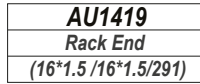
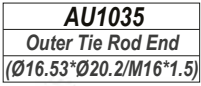
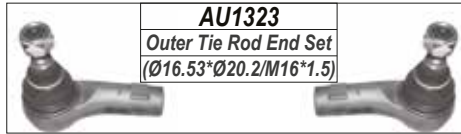

LEFT

RIGHT

PORSCHE

CAYENNE

FRONT

ALL MODELS

Year

2002-2010



S3

REAR

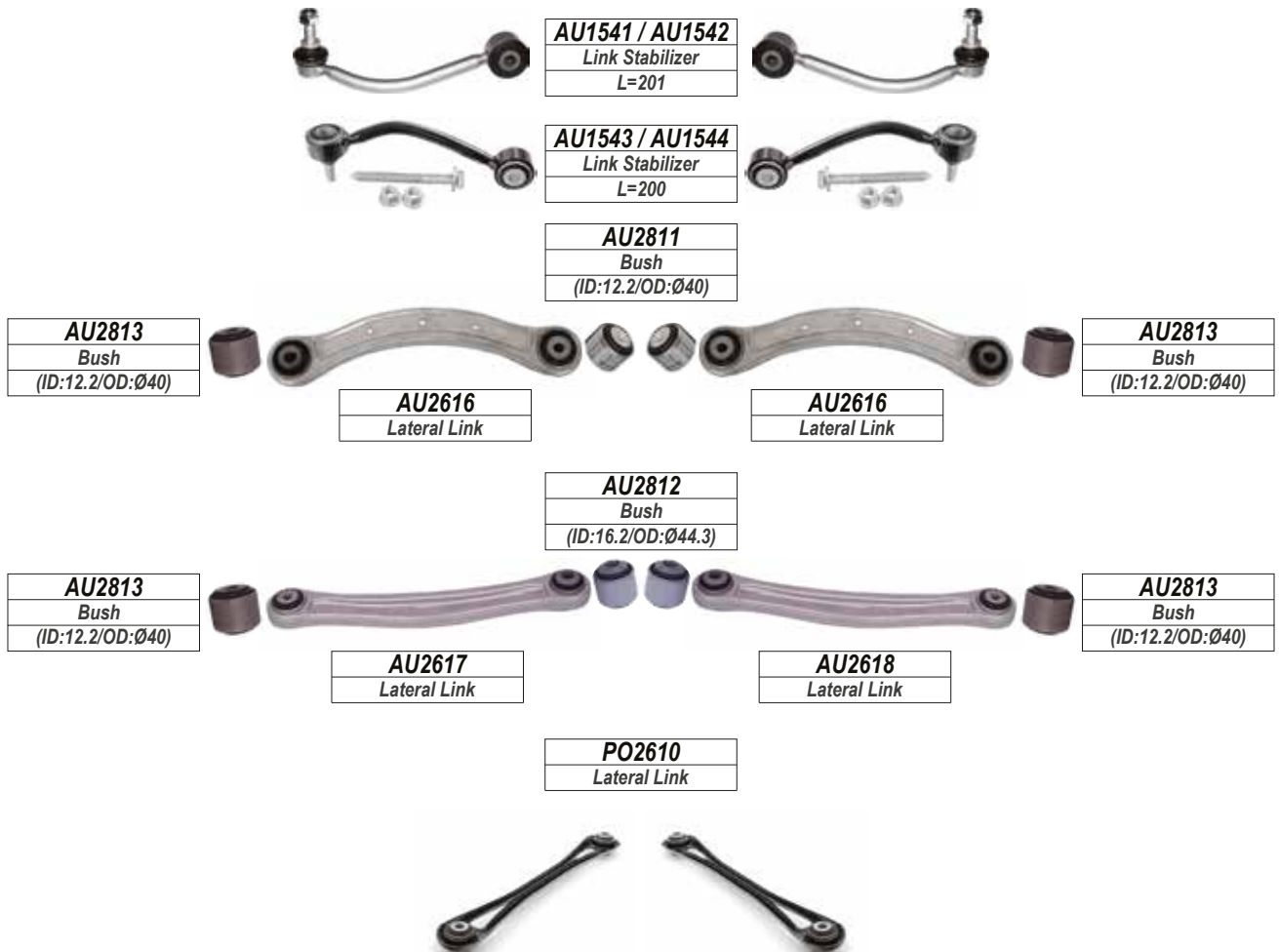

LEFT

RIGHT

PORSCHE

CAYENNE

FRONT

ALL MODELS

Year

2010-

AU1035
Outer Tie Rod End
(Ø16.53*Ø20.2/M16*1.5)

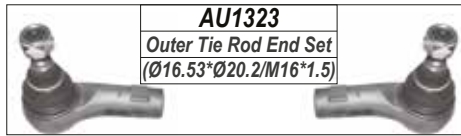

AU1323
Outer Tie Rod End Set
(Ø16.53*Ø20.2/M16*1.5)

AU1419
Rack End
(16*1.5 /16*1.5/291)

AU1036
Outer Tie Rod End
(Ø16.53*Ø20.2/M16*1.5)



AU1540
Link Stabilizer
L=197



PO1810
Upper Control Arm Bush

PO1710
Upper Control Arm

PO1710
Upper Control Arm

AU2135
Lower Control Arm Bush

AU2136
Lower Control Arm Bush

AU2136
Lower Control Arm Bush



AU2074
Lower Control Arm

AU2075
Lower Control Arm

AU2138
Lower Control Arm Bush

LEFT

RIGHT

PORSCHE

CAYENNE

REAR

ALL MODELS

Year

2010-



AU1541 / AU1542
Link Stabilizer
L=201

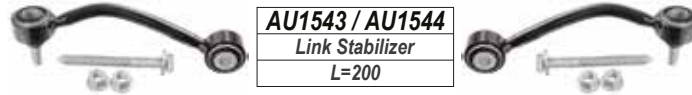

AU1543 / AU1544
Link Stabilizer
L=200

AU2811
Bush
(ID:12.2/OD:Ø40)



AU2616
Lateral Link

AU2616
Lateral Link

AU2813
Bush
(ID:12.2/OD:Ø40)

AU2813
Bush
(ID:12.2/OD:Ø40)

AU2812
Bush
(ID:16.2/OD:Ø44.3)



AU2617
Lateral Link

AU2618
Lateral Link

AU2813
Bush
(ID:12.2/OD:Ø40)

AU2813
Bush
(ID:12.2/OD:Ø40)

LEFT

RIGHT

PORSCHE

PANAMERA

FRONT

ALL MODELS

Year

2009-

PO1310
Outer Tie Rod End Set
(Ø16.82*Ø21.2/M14*1.5)



PO1010
Outer Tie Rod End
(Ø16.82*Ø21.2/M14*1.5)



PO1410
Rack End
(16*1.5 /14*1.5/204)



PO1011
Outer Tie Rod End
(Ø16.82*Ø21.2/M14*1.5)



PO1510
Link Stabilizer
L=158

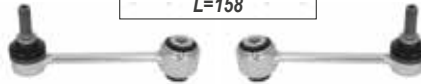

PO1511
Link Stabilizer
L=160

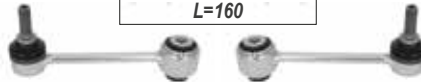

AU1813
Upper Control Arm Bush



PO1711
Upper Control Arm

PO1711
Upper Control Arm

PO2111
Lower Control Arm Bush



PO2112
Lower Control Arm Bush

PO2012
Lower Control Arm

PO2112
Lower Control Arm Bush

PO2013
Lower Control Arm

PO2110
Lower Control Arm Bush

LEFT

RIGHT

PORSCHE

PANAMERA

REAR

ALL MODELS

Year

2009-

PO1512
Link Stabilizer
L=200



PO2910
Bush

PO2910
Bush



PO2910
Bush

PO2611
Lateral Link

PO2611
Lateral Link

PO2910
Bush

PO2910
Bush



PO2910
Bush

PO2612
Lateral Link

PO2612
Lateral Link

LEFT

RIGHT

PROTON

GEN 2. PERSONA FRONT

ALL MODELS

Year

2004-

MI1319

Outer Tie Rod End Set
(Ø13.5*Ø15/M12*1.25)

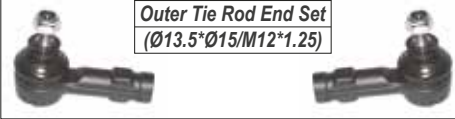

MI1014

Outer Tie Rod End
(Ø13.5*Ø15/M12*1.25)



PR1410

Rack End
(14*1.5/12*1.25/313)



MI1014

Outer Tie Rod End
(Ø13.5*Ø15/M12*1.25)



PR1510

Link Stabilizer
L=113



PR1910

Lower Ball Joint
(Ø15)



PR2010

Lower Control Arm

PR2011

Lower Control Arm

PR1910

Lower Ball Joint
(Ø15)



LEFT

RIGHT

RENAULT

9.11

FRONT

ALL MODELS

Year

1981-2000

RE1310
Outer Tie Rod End Set
($\varnothing 11.8 \times \varnothing 14.8 / M14 \times 1.5$)

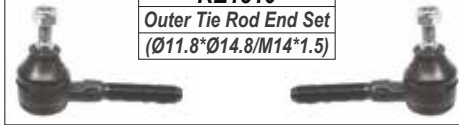

RE1010
Outer Tie Rod End
($\varnothing 11.8 \times \varnothing 14.8 / M14 \times 1.5$)



RE1410
Rack End
($12 \times 1.0 / 14 \times 1.5 / 176$)



RE1010
Outer Tie Rod End
($\varnothing 11.8 \times \varnothing 14.8 / M14 \times 1.5$)



RE2110
Lower Control Arm Bush



RE1910
Lower Ball Joint
($\varnothing 16$)



RE1910
Lower Ball Joint
($\varnothing 16$)



RE2010
Lower Control Arm

RE2011
Lower Control Arm

LEFT

RIGHT

RENAULT

CAPTUR

FRONT

ALL MODELS

Year

2014-

RE1011
Outer Tie Rod End
(Ø11.9*Ø14.5/M14*1.5)



RE1311
Outer Tie Rod End Set
(Ø11.9*Ø14.5/M14*1.5)

RE1411
Rack End
(16*1.5/14*1.5/224)

RE1012
Outer Tie Rod End
(Ø11.9*Ø14.5/M14*1.5)



NI1522
Link Stabilizer
L=248



RE2111
Lower Control Arm Bush



NI1931
Lower Ball Joint
(Ø18)



NI1931
Lower Ball Joint
(Ø18)



RE2012
Lower Control Arm



RE2013
Lower Control Arm



NI2122
Lower Control Arm Bush



LEFT

RIGHT

RENAULT

CLIO I

FRONT

ALL MODELS

Year

1990-2001

RE1312
Outer Tie Rod End Set
(Ø11.9*Ø14.5/M14*1.5)

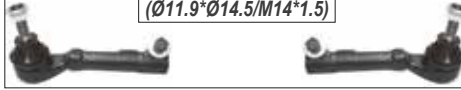

RE1013
Outer Tie Rod End
(Ø11.9*Ø14.5/M14*1.5)



RE1412
Rack End
(12*1.0/14*1.5/242)



RE1014
Outer Tie Rod End
(Ø11.9*Ø14.5/M14*1.5)



RE2112
Lower Control Arm Bush



RE1910
Lower Ball Joint
(Ø16)



RE1910
Lower Ball Joint
(Ø16)



RE2014
Lower Control Arm

RE2015
Lower Control Arm

NI2814
Shock Mounting



NI2815
Shock Mounting



LEFT

RIGHT

RENAULT

CLIO II

FRONT

ALL MODELS

Year

2001-2009

NI1018
Outer Tie Rod End
(Ø11.8*Ø14.8/M14*1.5)



NI1325
Outer Tie Rod End Set
(Ø11.8*Ø14.8/M14*1.5)

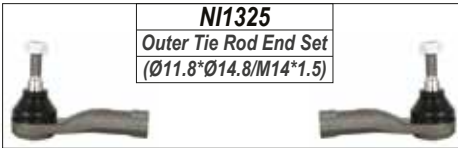

NI1030
Outer Tie Rod End
(Ø11.8*Ø14.8/M14*1.5)



RE1413
Rack End
(14*1.5/14*1.5/291)



RE1313
Outer Tie Rod End Set
(Ø11.8*Ø14.8/M14*1.5)



RE1015
Outer Tie Rod End
(Ø11.8*Ø14.8/M14*1.5)



RE1414
Rack End
(12*1.0/14*1.5/302)

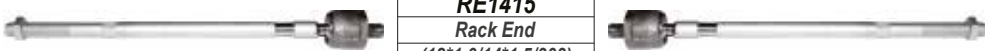

RE1016
Outer Tie Rod End
(Ø11.8*Ø14.8/M14*1.5)



RE1415
Rack End
(12*1.0/14*1.5/303)

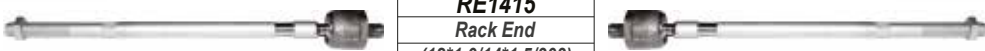

RE1910
Lower Ball Joint
(Ø16)(10.5mm Hole)



RE2113
Lower Control Arm Bush



RE1910
Lower Ball Joint
(Ø16)(10.5mm Hole)



RE1911
Lower Ball Joint
(Ø16)(12.5mm Hole)



RE2016
Lower Control Arm

RE2017
Lower Control Arm

RE1911
Lower Ball Joint
(Ø16)(12.5mm Hole)



RE2819
Shock Mounting



RE2710
Repair Kit



RE2710
Repair Kit



RE2819
Shock Mounting



NI2814
Shock Mounting



NI2815
Shock Mounting



LEFT

RIGHT

RENAULT

CLIO III

FRONT

ALL MODELS

Year

2005-2012

NI1325
Outer Tie Rod End Set
(Ø11.8*Ø14.8/M14*1.5)

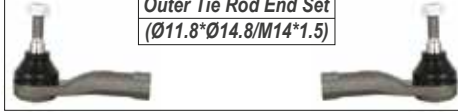

NI1018
Outer Tie Rod End
(Ø11.8*Ø14.8/M14*1.5)



NI1419
Rack End
(14*1.5/14*1.5/308)



NI1030
Outer Tie Rod End
(Ø11.8*Ø14.8/M14*1.5)



NI1522
Link Stabilizer
L=248



NI2117
Lower Control Arm Bush



NI1931
Lower Ball Joint
(Ø18)



NI1931
Lower Ball Joint
(Ø18)



NI2040
Lower Control Arm



NI2041
Lower Control Arm



NI2814
Shock Mounting



NI2118
Lower Control Arm Bush



NI2815
Shock Mounting



NI2911
Stabilizer Bar Bush



NI2814
Shock Mounting



NI2815
Shock Mounting



LEFT

RIGHT

RENAULT

CLIO IV

FRONT

ALL MODELS

Year

2013-

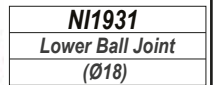
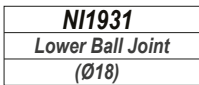
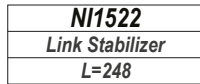
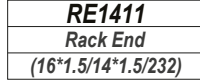
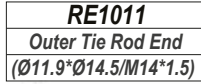

LEFT

RIGHT

RENAULT

CLIO V

FRONT

ALL MODELS

Year

2020-

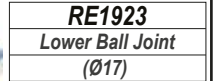
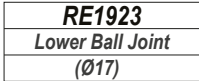
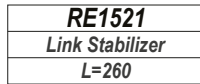
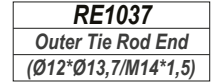
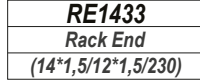
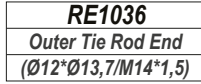

LEFT

RIGHT

RENAULT

DUSTER

FRONT

ALL MODELS

Year

2010-

RE1314
Outer Tie Rod End Set
(Ø11.9*Ø14.8/M14*1.5)



RE1017
Outer Tie Rod End
(Ø11.9*Ø14.8/M14*1.5)



RE1416
Rack End
(16*1.5/14*1.5/203)



RE1018
Outer Tie Rod End
(Ø11.9*Ø14.8/M14*1.5)



RE1510
Link Stabilizer
L=294



RE2114
Lower Control Arm Bush



RE1912
Lower Ball Joint
(Ø17.2)



RE1912
Lower Ball Joint
(Ø17.2)



RE2020
Lower Control Arm

RE2021
Lower Control Arm

NI2821
Shock Mounting



RE2810
Stabilizer Bar Bush



NI2821
Shock Mounting



DUSTER

REAR

RE2910
Bush



LEFT

RIGHT

RENAULT

ESPACE

FRONT

III

Year

1996-2002

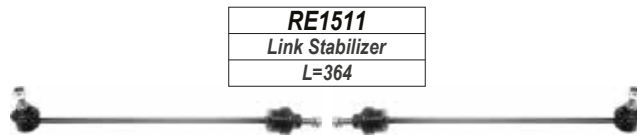

LEFT

RIGHT

RENAULT

SPACE

FRONT

IV

Year

2002-

NI1335
Outer Tie Rod End Set
(Ø12*Ø14.6/M14*1.5)



NI1041
Outer Tie Rod End
(Ø12*Ø14.6/M14*1.5)



RE1418
Rack End
(12*1.0/14*1.5/248)



NI1042
Outer Tie Rod End
(Ø12*Ø14.6/M14*1.5)



NI1536
Link Stabilizer
L=279



NI2123
Lower Control Arm Bush



RE2024
Lower Control Arm

RE2025
Lower Control Arm

RE2117
Lower Control Arm Bush

NI1921
Lower Ball Joint
(Ø17.84)



NI1921
Lower Ball Joint
(Ø17.84)



NI2123
Lower Control Arm Bush



NI2044
Lower Control Arm

NI2045
Lower Control Arm

RE2117
Lower Control Arm Bush

LEFT

RIGHT

RENAULT

FLUENCE

FRONT

ALL MODELS

Year

2011-

NI1335
Outer Tie Rod End Set
(Ø12*Ø14.6/M14*1.5)



NI1041
Outer Tie Rod End
(Ø12*Ø14.6/M14*1.5)

RE1419
Rack End
(14*1.5/14*1.5/209)

NI1042
Outer Tie Rod End
(Ø12*Ø14.6/M14*1.5)



RE1512
Link Stabilizer
L=264



RE2119
Lower Control Arm Bush

RE1914
Lower Ball Joint
(Ø17.2)



RE1914
Lower Ball Joint
(Ø17.2)

RE2026
Lower Control Arm

RE2027
Lower Control Arm

RE2118
Lower Control Arm Bush

RE2811
Stabilizer Bar Bush
ID:20



RE2812
Stabilizer Bar Bush
ID:22.5



RE2816
Shock Mounting



RE2816
Shock Mounting



LEFT

RIGHT

RENAULT

GRAND SCENIC

FRONT

II

Year

2004-2009

RE1316
Outer Tie Rod End Set
(Ø11.8*Ø14.8/M14*1.5)



RE1021
Outer Tie Rod End
(Ø11.8*Ø14.8/M14*1.5)



RE1420
Rack End
(14*1.5/14*1.5/217)



RE1022
Outer Tie Rod End
(Ø11.8*Ø14.8/M14*1.5)



RE1513
Link Stabilizer
L=266



RE1514
Link Stabilizer
L=283

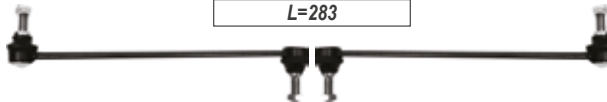

NI1931
Lower Ball Joint
(Ø18)



RE2111
Lower Control Arm Bush



NI1931
Lower Ball Joint
(Ø18)



RE2012
Lower Control Arm

RE2013
Lower Control Arm

NI2122
Lower Control Arm Bush

RE2111
Lower Control Arm Bush

RE1915
Lower Ball Joint
(Ø16)



RE1915
Lower Ball Joint
(Ø16)



RE2028
Lower Control Arm



RE2029
Lower Control Arm

RE2817
Shock Mounting



NI2122
Lower Control Arm Bush

RE2817
Shock Mounting



LEFT

RIGHT

RENAULT

GRAND SCENIC

FRONT

III

Year

2010-

RE1317
Outer Tie Rod End Set
(Ø11.85*Ø14.7/M14*1.5)



RE1023
Outer Tie Rod End
(Ø11.85*Ø14.7/M14*1.5)



RE1419
Rack End
(14*1.5/14*1.5/209)



RE1024
Outer Tie Rod End
(Ø11.85*Ø14.7/M14*1.5)



RE1515
Link Stabilizer
L=274



RE2119
Lower Control Arm Bush



RE2026
Lower Control Arm

RE2027
Lower Control Arm

RE1914
Lower Ball Joint
(Ø17.2)



RE1914
Lower Ball Joint
(Ø17.2)



RE2118
Lower Control Arm Bush

RE2119
Lower Control Arm Bush



RE2030
Lower Control Arm

RE2031
Lower Control Arm

RE2818
Shock Mounting



RE2130
Lower Control Arm Bush

RE2811
Stabilizer Bar Bush
ID:20



RE2812
Stabilizer Bar Bush
ID:22.5



RE2818
Shock Mounting



LEFT

RIGHT

RENAULT

KADJAR

FRONT

ALL MODELS

Year

2016-

NI1046
Outer Tie Rod End
(Ø11.8*Ø14.6/M14*1.5)



NI1338
Outer Tie Rod End Set
(Ø11.8*Ø14.6/M14*1.5)

RE1421
Rack End
(16*1.5/14*1.5/214)

NI1047
Outer Tie Rod End
(Ø11.8*Ø14.6/M14*1.5)



NI1517
Link Stabilizer
L=284



NI1930
Lower Ball Joint
(Ø20)



NI2128
Lower Control Arm Bush



NI2052
Lower Control Arm

NI2053
Lower Control Arm

NI1930
Lower Ball Joint
(Ø20)



NI2129
Lower Control Arm Bush

LEFT

RIGHT

RENAULT

KANGOO

FRONT

Year

1999-2009

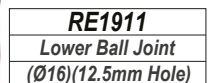
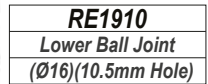
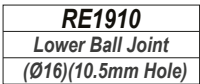
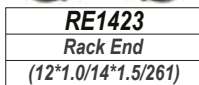
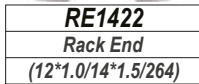
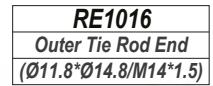
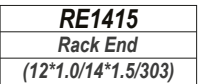
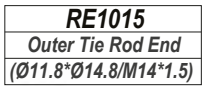
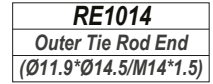
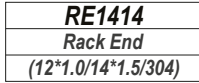
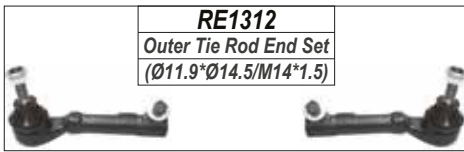

LEFT

RIGHT

RENAULT

KANGOO

FRONT

II

Year

2008-

RE1318
Outer Tie Rod End Set
(Ø11.85*Ø14.7/M14*1.5)



RE1025
Outer Tie Rod End
(Ø11.85*Ø14.7/M14*1.5)



RE1424
Rack End
(14*1.5/14*1.5/214)



RE1026
Outer Tie Rod End
(Ø11.85*Ø14.7/M14*1.5)



RE1419
Rack End
(14*1.5/14*1.5/209)



RE1514
Link Stabilizer
L=283



RE2120
Lower Control Arm Bush



RE1916
Lower Ball Joint
(Ø20)



RE1917
Lower Ball Joint
(Ø20)



RE2032
Lower Control Arm



RE2033
Lower Control Arm



RE2121
Lower Control Arm Bush



RE2819
Shock Mounting



RE2819
Shock Mounting



LEFT

RIGHT

RENAULT

KOLEOS

FRONT

ALL MODELS

Year

2008-

RE1319
Outer Tie Rod End Set
(Ø11.7*Ø14.8/M14*1.5)



RE1027
Outer Tie Rod End
(Ø11.7*Ø14.8/M14*1.5)



NI1428
Rack End
(22*1.5/14*1.5/233)



RE1028
Outer Tie Rod End
(Ø11.7*Ø14.8/M14*1.5)



NI1527 / NI1528
Link Stabilizer
L=300

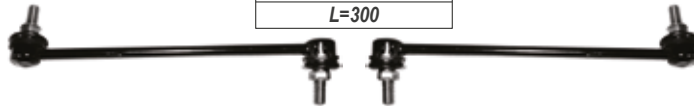

NI1930
Lower Ball Joint
(Ø20)



NI2127
Lower Control Arm Bush



NI1930
Lower Ball Joint
(Ø20)



NI2050
Lower Control Arm

NI2051
Lower Control Arm

NI2822
Shock Mounting



NI2114
Lower Control Arm Bush



NI2823
Shock Mounting



KOLEOS

REAR

NI1539 / NI1540
Link Stabilizer
L=143.5



LEFT

RIGHT

RENAULT

KWID

FRONT

ALL MODELS

Year

2017-

RE1320
Outer Tie Rod End Set

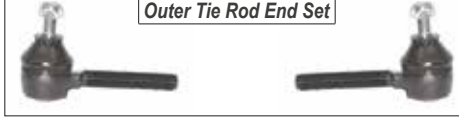

RE1035
Outer Tie Rod End

RE1035
Outer Tie Rod End

RE1431
Rack End



RE2128
Lower Control Arm Bush

RE1922
Lower Ball Joint



RE1922
Lower Ball Joint



RE2046
Lower Control Arm

RE2047
Lower Control Arm

RE2129
Lower Control Arm Bush

LEFT

RIGHT

RENAULT

LAGUNA

FRONT

ALL MODELS

Year

1996-2001

RE1321
Outer Tie Rod End Set
(Ø11.8*Ø14.8/M14*1.5)



RE1029
Outer Tie Rod End
(Ø11.8*Ø14.8/M14*1.5)

RE1425
Rack End
(12*1.0/14*1.5/267)

RE1030
Outer Tie Rod End
(Ø11.8*Ø14.8/M14*1.5)



RE1511
Link Stabilizer
L=384



RE2115
Lower Control Arm Bush



RE1918
Lower Ball Joint
(Ø14.5)



RE1918
Lower Ball Joint
(Ø14.5)



RE2034
Lower Control Arm



RE2035
Lower Control Arm

RE2122
Lower Control Arm Bush



RE2820
Shock Mounting



RE2821
Shock Mounting



LEFT

RIGHT

RENAULT

LAGUNA

FRONT

ALL MODELS

Year

2002-2007

NI1335
Outer Tie Rod End Set
(Ø12*Ø14.6/M14*1.5)

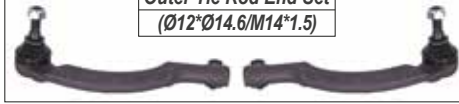

NI1041
Outer Tie Rod End
(Ø12*Ø14.6/M14*1.5)



RE1426
Rack End
(12*1.0/14*1.5/218)



NI1042
Outer Tie Rod End
(Ø12*Ø14.6/M14*1.5)



NI1536
Link Stabilizer
L=279



NI1921
Lower Ball Joint
(Ø17.84)



NI2123
Lower Control Arm Bush



NI1921
Lower Ball Joint
(Ø17.84)



RE2024
Lower Control Arm



RE2025
Lower Control Arm

RE2820
Shock Mounting



RE2117
Lower Control Arm Bush



RE2821
Shock Mounting



RE2813
Stabilizer Bar Bush



LAGUNA

REAR

RE2911
Bush



RE2912
Bush



LEFT

RIGHT

RENAULT

LAGUNA

FRONT

ALL MODELS

Year

2009-

RE1322
Outer Tie Rod End Set
(Ø13.9*Ø18.9/M14*1.5)



RE1031
Outer Tie Rod End
(Ø13.9*Ø18.9/M14*1.5)

RE1427
Rack End
(14*1.5/14*1.5/188)

RE1032
Outer Tie Rod End
(Ø13.9*Ø18.9/M14*1.5)



RE1516
Link Stabilizer
L=294



RE2123
Lower Control Arm Bush

RE1919
Lower Ball Joint
(Ø15.9)



RE1919
Lower Ball Joint
(Ø15.9)



RE2036
Lower Control Arm

RE2037
Lower Control Arm

LEFT

RIGHT

RENAULT

LOGAN

FRONT

ALL MODELS

Year

2009-

NI1036
Outer Tie Rod End
(Ø12*Ø14.5/M14*1.5)

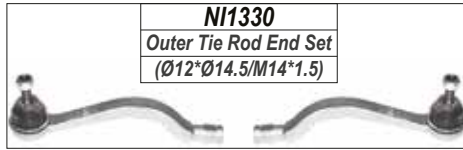

NI1330
Outer Tie Rod End Set
(Ø12*Ø14.5/M14*1.5)

NI1423
Rack End
(12*1.0/14*1.5/194)



NI1037
Outer Tie Rod End
(Ø12*Ø14.5/M14*1.5)



MN1411
Rack End
(14*1.5/14*1.5/196)



NI1931
Lower Ball Joint
(Ø18)



NI1931
Lower Ball Joint
(Ø18)

NI2038
Lower Control Arm

NI2039
Lower Control Arm

NI2121
Lower Control Arm Bush

NI2821
Shock Mounting



NI2821
Shock Mounting



LEFT

RIGHT

RENAULT

MEGANE.SCENIC FRONT

Year

1997-2003

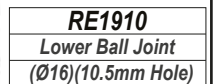
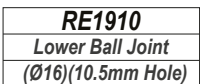
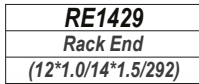
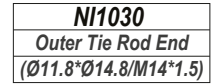
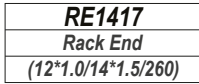
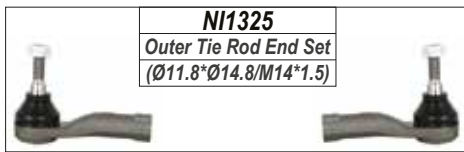
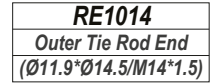
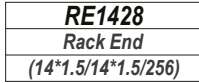
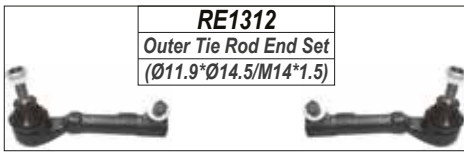

LEFT

RIGHT

RENAULT

MEGANE.SCENIC FRONT

Year

1997-2003



LEFT

RIGHT

RENAULT

MEGANE.SCENIC FRONT

Year

2004-2009

II

RE1316
Outer Tie Rod End Set
(Ø11.8*Ø14.8/M14*1.5)



RE1021
Outer Tie Rod End
(Ø11.8*Ø14.8/M14*1.5)



RE1420
Rack End
(14*1.5/14*1.5/217)



RE1022
Outer Tie Rod End
(Ø11.8*Ø14.8/M14*1.5)



RE1513
Link Stabilizer
L=266



RE1514
Link Stabilizer
L=283

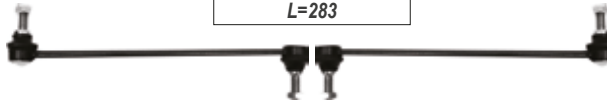

RE2111
Lower Control Arm Bush



NI1931
Lower Ball Joint
(Ø18)



NI1931
Lower Ball Joint
(Ø18)



RE2012
Lower Control Arm

RE2013
Lower Control Arm

NI2122
Lower Control Arm Bush

RE2111
Lower Control Arm Bush

RE1915
Lower Ball Joint
(Ø16)



RE1915
Lower Ball Joint
(Ø16)



RE2817
Shock Mounting



RE2028
Lower Control Arm

RE2029
Lower Control Arm

RE2817
Shock Mounting



NI2122
Lower Control Arm Bush

LEFT

RIGHT

RENAULT

MEGANE.SCENIC FRONT

Year

2010-2015

III

RE1317
Outer Tie Rod End Set
(Ø11.85*Ø14.7/M14*1.5)



RE1023
Outer Tie Rod End
(Ø11.85*Ø14.7/M14*1.5)



RE1419
Rack End
(14*1.5/14*1.5/209)



RE1024
Outer Tie Rod End
(Ø11.85*Ø14.7/M14*1.5)



RE1515
Link Stabilizer
L=274



RE2119
Lower Control Arm Bush



RE2026
Lower Control Arm

RE2027
Lower Control Arm

RE1914
Lower Ball Joint
(Ø17.2)



RE1914
Lower Ball Joint
(Ø17.2)



RE2118
Lower Control Arm Bush

RE2119
Lower Control Arm Bush



RE2030
Lower Control Arm

RE2031
Lower Control Arm

RE2818
Shock Mounting



RE2130
Lower Control Arm Bush

RE2818
Shock Mounting



LEFT

RIGHT

RENAULT

MEGANE

FRONT

IV

Year

2015-

RE1323
Outer Tie Rod End Set
(Ø11.8*Ø14.9/M14*1.5)

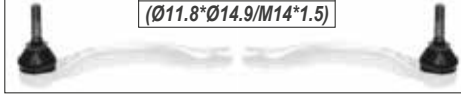

RE1033
Outer Tie Rod End
(Ø11.8*Ø14.9/M14*1.5)



RE1430
Rack End
(14*1.5/14*1.5/209)



RE1034
Outer Tie Rod End
(Ø11.8*Ø14.9/M14*1.5)



RE1518
Link Stabilizer
L=273.5



RE2126
Lower Control Arm Bush



RE1921
Lower Ball Joint
(Ø18)



RE1921
Lower Ball Joint
(Ø18)



RE2044
Lower Control Arm



RE2045
Lower Control Arm



RE2127
Lower Control Arm Bush



LEFT

RIGHT

RENAULT

MODUS

FRONT

ALL MODELS

Year

2005-2009

NI1018
Outer Tie Rod End
(Ø11.8*Ø14.8/M14*1.5)

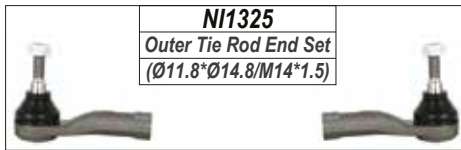

NI1325
Outer Tie Rod End Set
(Ø11.8*Ø14.8/M14*1.5)

NI1419
Rack End
(14*1.5/14*1.5/308)

NI1030
Outer Tie Rod End
(Ø11.8*Ø14.8/M14*1.5)



NI1522
Link Stabilizer
L=248



NI2117
Lower Control Arm Bush



NI1931
Lower Ball Joint
(Ø18)



NI1931
Lower Ball Joint
(Ø18)



NI2040
Lower Control Arm



NI2041
Lower Control Arm



NI2118
Lower Control Arm Bush



NI2814
Shock Mounting



NI2815
Shock Mounting



LEFT

RIGHT

RENAULT

SANDERO

FRONT

ALL MODELS

Year

2009-

NI1330
Outer Tie Rod End Set
(Ø12*Ø14.5/M14*1.5)

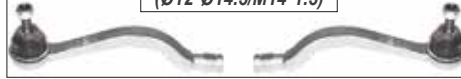

NI1036
Outer Tie Rod End
(Ø12*Ø14.5/M14*1.5)



NI1423
Rack End
(12*1.0/14*1.5/194)



NI1037
Outer Tie Rod End
(Ø12*Ø14.5/M14*1.5)



MN1411
Rack End
(14*1.5/14*1.5/196)



NI1931
Lower Ball Joint
(Ø18)



NI1931
Lower Ball Joint
(Ø18)



NI2121
Lower Control Arm Bush



NI2038
Lower Control Arm



NI2039
Lower Control Arm



RE2910
Bush



NI2821
Shock Mounting



RE2712
Repair Kit



NI2821
Shock Mounting



LEFT

RIGHT

RENAULT

TRAFIC

FRONT

ALL MODELS

Year

2005-2008

NI1335
Outer Tie Rod End Set
(Ø12*Ø14.6/M14*1.5)

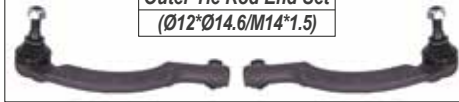

NI1041
Outer Tie Rod End
(Ø12*Ø14.6/M14*1.5)



RE1426
Rack End
(12*1.0/14*1.5/263)



NI1042
Outer Tie Rod End
(Ø12*Ø14.6/M14*1.5)



NI1536
Link Stabilizer
L=279



NI1921
Lower Ball Joint
(Ø17.84)



NI2123
Lower Control Arm Bush



NI1921
Lower Ball Joint
(Ø17.84)



NI2044
Lower Control Arm

NI2045
Lower Control Arm

RE2117
Lower Control Arm Bush

NI2123
Lower Control Arm Bush

OP1919
Lower Ball Joint
(Ø17.84)



OP1919
Lower Ball Joint
(Ø17.84)



OP2030
Lower Control Arm

OP2031
Lower Control Arm

NI2824
Shock Mounting



OP2122
Lower Control Arm Bush

NI2824
Shock Mounting



LEFT

RIGHT

ROVER

75 SERIES

FRONT

Year

ALL MODELS

1999-

RO1010
Outer Tie Rod End



RO1310
Outer Tie Rod End Set

RO1011
Outer Tie Rod End



RO1510
Link Stabilizer
L=285

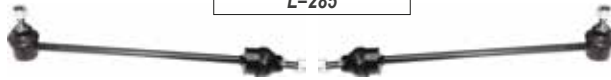

AU1515 / AU1516
Link Stabilizer
L=340



RO2010
Lower Control Arm

RO2011
Lower Control Arm

RO2110 / RO2111
Lower Control Bush



75 SERIES

REAR

RO1511 / RO1512
Link Stabilizer
L=105

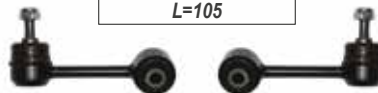

LEFT

RIGHT

SAAB

9-3

FRONT

ALL MODELS

Year

1998-2003

OP1016
Outer Tie Rod End
(Ø13*Ø15.5/M16*2)

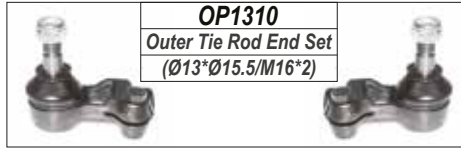

OP1310
Outer Tie Rod End Set
(Ø13*Ø15.5/M16*2)

OP1423
Rack End
(16*2.0/16*2.0/100)



OP1017
Outer Tie Rod End
(Ø13*Ø15.5/M16*2)



OP1424 / OP1425
Rack End



OP1513
Link Stabilizer
L=85



SA2010
Lower Control Arm

SA2011
Lower Control Arm

SA2910
Bush



LEFT

RIGHT

SAAB

9-3

FRONT

ALL MODELS

Year

2003-2012

SA1010
Outer Tie Rod End
(Ø12.3*Ø17/M14*1.5)



SA1310
Outer Tie Rod End Set
(Ø12.3*Ø17/M14*1.5)

SA1011
Outer Tie Rod End
(Ø12.3*Ø17/M14*1.5)



SA1410
Rack End
(14*1.5/14*1.5/295)



SA1510
Link Stabilizer
L=352.5



OP2114
Lower Control Arm Bush



SA2012
Lower Control Arm

SA2013
Lower Control Arm

SA2110
Lower Control Arm Bush



SA2810
Stabilizer Bar Bush
ID:24 OD:42.5



SA2811
Stabilizer Bar Bush
ID:22 OD:43



LEFT

RIGHT

SAAB

9-3

REAR

ALL MODELS

Year

2003-2012

SA1511
Link Stabilizer
L=86



SA2610
Lateral Link



SA2610
Lateral Link

SA2812
Stabilizer Bar Bush
ID:18 OD:38



SA2813
Stabilizer Bar Bush
ID:17 OD:38



SA2814
Stabilizer Bar Bush
ID:19 OD:38



SA2911
Stabilizer Bar Bush
ID:12 OD:45.5



SA2912
Stabilizer Bar Bush
ID:12.8 OD:70.3



LEFT

RIGHT

SAAB

9-5

FRONT

ALL MODELS

Year

1998-2010

SA1012
Outer Tie Rod End
(Ø13.4*Ø16.4/M14*1.5)

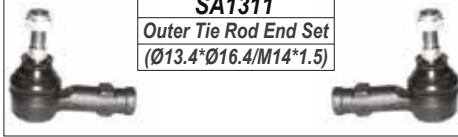

SA1311
Outer Tie Rod End Set
(Ø13.4*Ø16.4/M14*1.5)

SA1411
Rack End
(16*1.5/14*1.5/345)

SA1012
Outer Tie Rod End
(Ø13.4*Ø16.4/M14*1.5)



SA1010
Outer Tie Rod End
(Ø12.3*Ø17/M14*1.5)

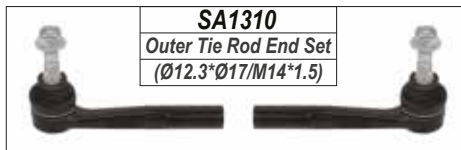

SA1310
Outer Tie Rod End Set
(Ø12.3*Ø17/M14*1.5)

SA1412
Rack End
(16*1.5/14*1.5/283)

SA1011
Outer Tie Rod End
(Ø12.3*Ø17/M14*1.5)



OP1520
Link Stabilizer
L=243



SA1910
Lower Ball Joint
(Ø20)



SA1910
Lower Ball Joint
(Ø20)



OP1915
Lower Ball Joint
(Ø18)



OP1915
Lower Ball Joint
(Ø18)



9-5

REAR

SA2913
Bush



SA2611
Lateral Link
L=525



SA2611
Lateral Link
L=525



SA2914
Bush



LEFT

RIGHT

SAAB

900

FRONT

ALL MODELS

Year

1995-1998

OP1016
Outer Tie Rod End
(Ø13*Ø15.5/M16*2)

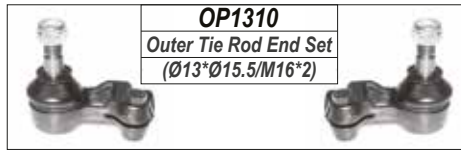

OP1310
Outer Tie Rod End Set
(Ø13*Ø15.5/M16*2)

OP1423
Rack End
(16*2.0/16*2.0/100)



OP1017
Outer Tie Rod End
(Ø13*Ø15.5/M16*2)



OP1424 / OP1425
Rack End



OP1511
Link Stabilizer
L=79.5



OP1513
Link Stabilizer
L=85



SA1512
Link Stabilizer
L=89.5



SA2010
Lower Control Arm

SA2011
Lower Control Arm

SA2910
Bush



LEFT

RIGHT

SAAB

9000

FRONT

Year

ALL MODELS

1989-1998

SA1013
Outer Tie Rod End
(Ø12.92*Ø14.8/M14*1.5)



SA1312
Outer Tie Rod End Set
(Ø12.92*Ø14.8/M14*1.5)

SA1413
Rack End
(14*1.5/14*1.5/296)

SA1013
Outer Tie Rod End
(Ø12.92*Ø14.8/M14*1.5)

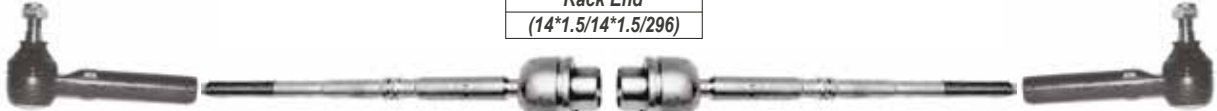

AF1520
Link Stabilizer
L=106



SA1513
Link Stabilizer
L=112.5



SA1911
Lower Ball Joint
(Ø20)



SA2014
Lower Control Arm



SA2015
Lower Control Arm

SA1911
Lower Ball Joint
(Ø20)



LEFT

RIGHT

SEAT

ALTEA

FRONT

ALL MODELS

Year

2004-2011

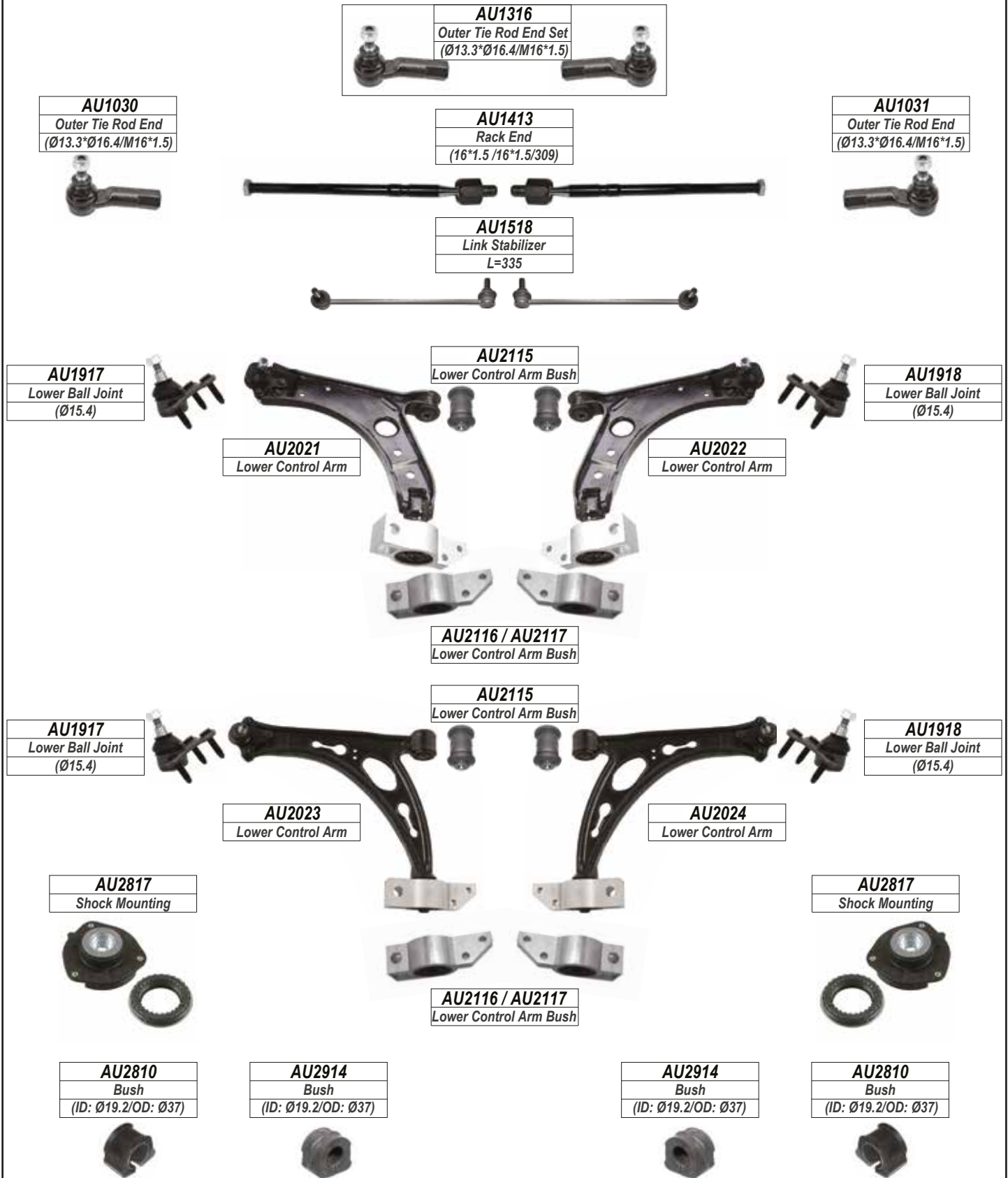

AU1030
Outer Tie Rod End
(Ø13.3*Ø16.4/M16*1.5)

AU1316
Outer Tie Rod End Set
(Ø13.3*Ø16.4/M16*1.5)

AU1413
Rack End
(16*1.5 /16*1.5/309)

AU1031
Outer Tie Rod End
(Ø13.3*Ø16.4/M16*1.5)

AU1518
Link Stabilizer
L=335

AU1917
Lower Ball Joint
(Ø15.4)

AU2115
Lower Control Arm Bush

AU1918
Lower Ball Joint
(Ø15.4)

AU2021
Lower Control Arm

AU2022
Lower Control Arm

AU2116 / AU2117
Lower Control Arm Bush

AU1917
Lower Ball Joint
(Ø15.4)

AU2115
Lower Control Arm Bush

AU1918
Lower Ball Joint
(Ø15.4)

AU2023
Lower Control Arm

AU2024
Lower Control Arm

AU2817
Shock Mounting

AU2817
Shock Mounting

AU2116 / AU2117
Lower Control Arm Bush

AU2810
Bush
(ID: Ø19.2/OD: Ø37)

AU2914
Bush
(ID: Ø19.2/OD: Ø37)

AU2914
Bush
(ID: Ø19.2/OD: Ø37)

AU2810
Bush
(ID: Ø19.2/OD: Ø37)

LEFT

RIGHT

SEAT

ALTEA

REAR

ALL MODELS

Year

2004-2011

AU1519
Link Stabilizer
L=95.5



AU2915
Bush
(ID: Ø14.3/OD: Ø24.3)



VW2911
Bush



VW2911
Bush

AU2610
Lateral Link

AU2610
Lateral Link

AU1710
Upper Control Arm



AU2080 / AU2081
Lower Control Arm



VW2114
Lower Control Arm Bush



VW2014
Lower Control Arm



VW2014
Lower Control Arm



AU2818
Shock Mounting



AU2818
Shock Mounting



LEFT

RIGHT

SEAT

IBIZA

FRONT

Year

2006-2008

IV

SE1010
Outer Tie Rod End
(Ø12.7*Ø14.7/M14*1.5)

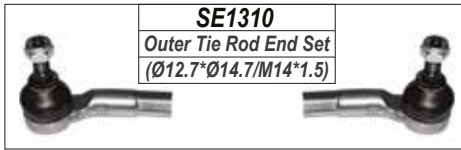

SE1310
Outer Tie Rod End Set
(Ø12.7*Ø14.7/M14*1.5)

VW1424
Rack End
(14*1.5/14*1.5/297)



SE1011
Outer Tie Rod End
(Ø12.7*Ø14.7/M14*1.5)



AU1511
Link Stabilizer
L=271



SE2110
Lower Control Arm Bush

SE1910
Lower Ball Joint
(Ø14.9)



SE2010
Lower Control Arm

SE2010
Lower Control Arm

SE1911
Lower Ball Joint
(Ø14.9)



SE2111
Lower Control Arm Bush

IBIZA

REAR

AU2912
Bush
(ID: Ø12.2/OD: Ø71.5)



AU2815
Shock Mounting



AU2815
Shock Mounting



LEFT

RIGHT

SEAT

IBIZA

FRONT

Year

2008-

V

AU1315
Outer Tie Rod End Set
(Ø13.2*Ø17.2/M14*1.5)

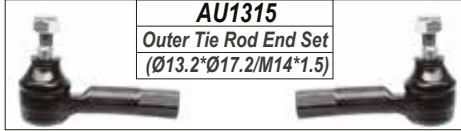

AU1020
Outer Tie Rod End
(Ø13.2*Ø17.2/M14*1.5)



SE1412
Rack End
(14*1.5 /14*1.5/294)



AU1021
Outer Tie Rod End
(Ø13.2*Ø17.2/M14*1.5)



AU1313
Outer Tie Rod End Set
(Ø13.2*Ø17.2/M14*1.5)

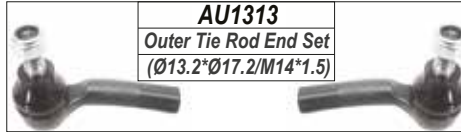

AU1016
Outer Tie Rod End
(Ø13.2*Ø17.2/M14*1.5)



AU1410
Rack End
(14*1.5 /14*1.5/310)



AU1017
Outer Tie Rod End
(Ø13.2*Ø17.2/M14*1.5)



AU1511
Link Stabilizer
L=271

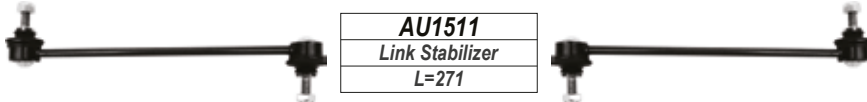

VW2040
Lower Control Arm



AU2113
Lower Control Arm Bush



AU2114
Lower Control Arm Bush



VW2041
Lower Control Arm



AU1913
Lower Ball Joint
(Ø14.9)



AU1914
Lower Ball Joint
(Ø14.9)



AU2016
Lower Control Arm



AU2113
Lower Control Arm Bush



AU2114
Lower Control Arm Bush



AU2017
Lower Control Arm



AU2814
Shock Mounting



AU2814
Shock Mounting



IBIZA

REAR

AU2815
Shock Mounting



AU2912
Bush
(ID: Ø12.2/OD: Ø71.5)

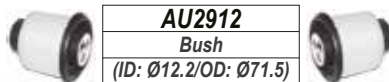

AU2815
Shock Mounting



LEFT

RIGHT

SEAT

LEON

FRONT

ALL MODELS

Year

2005-2012

AU1316
Outer Tie Rod End Set
(Ø13.3*Ø16.4/M16*1.5)

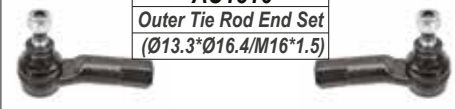

AU1030
Outer Tie Rod End
(Ø13.3*Ø16.4/M16*1.5)



AU1413
Rack End
(16*1.5 /16*1.5/309)



AU1031
Outer Tie Rod End
(Ø13.3*Ø16.4/M16*1.5)



AU1518
Link Stabilizer
L=335



AU2115
Lower Control Arm Bush



AU1917
Lower Ball Joint
(Ø15.4)



AU1918
Lower Ball Joint
(Ø15.4)



AU2021
Lower Control Arm



AU2022
Lower Control Arm



AU2116 / AU2117
Lower Control Arm Bush



AU2115
Lower Control Arm Bush



AU1917
Lower Ball Joint
(Ø15.4)



AU1918
Lower Ball Joint
(Ø15.4)



AU2023
Lower Control Arm



AU2024
Lower Control Arm



AU2817
Shock Mounting



AU2817
Shock Mounting



AU2116 / AU2117
Lower Control Arm Bush



AU2810
Bush
(ID: Ø19.2/OD: Ø37)



AU2914
Bush
(ID: Ø19.2/OD: Ø37)



AU2914
Bush
(ID: Ø19.2/OD: Ø37)



AU2810
Bush
(ID: Ø19.2/OD: Ø37)



LEFT

RIGHT

SEAT

LEON

REAR

ALL MODELS

Year

2005-2012

AU1519
Link Stabilizer
L=95.5



AU2915
Bush
(ID: Ø14.3/OD: Ø24.3)



VW2911
Bush

VW2911
Bush

AU2610
Lateral Link

AU2610
Lateral Link



AU1710
Upper Control Arm



AU2080 / AU2081
Lower Control Arm

VW2114
Lower Control Arm Bush



VW2014
Lower Control Arm

VW2014
Lower Control Arm

AU2818
Shock Mounting



AU2818
Shock Mounting



LEFT

RIGHT

SMART

CABRIO. COUPE. FRONT
ROADSTAR.FORTWO

ALL MODELS

Year

2000-2006

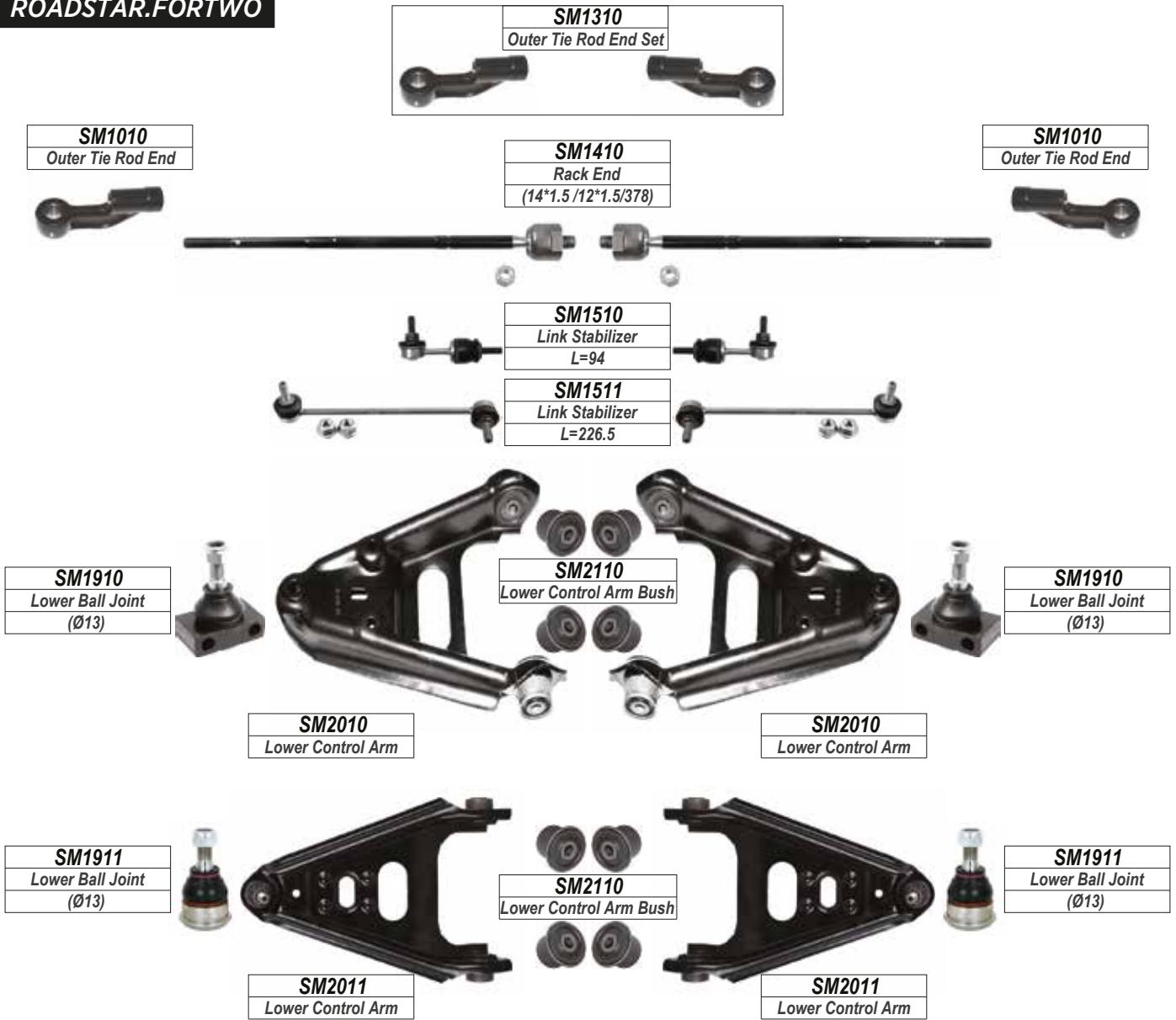

CABRIO. COUPE. REAR
ROADSTAR.FORTWO



LEFT

RIGHT

SMART

FORFOUR

FRONT

ALL MODELS

Year

2004-2006

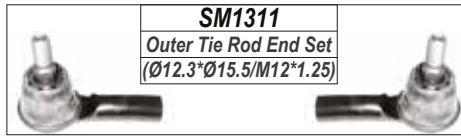

SM1011
Outer Tie Rod End
(Ø12.3*Ø15.5/M12*1.25)



SM1011
Outer Tie Rod End
(Ø12.3*Ø15.5/M12*1.25)



SM1513
Link Stabilizer
L=324



SM1912
Lower Ball Joint
(Ø14.5)



CI2121
Lower Control Arm Bush



SM1912
Lower Ball Joint
(Ø14.5)



SM2012
Lower Control Arm

SM2013
Lower Control Arm

CI2120
Lower Control Arm Bush

LEFT

RIGHT

SSANGYONG

ACTYON

FRONT

ALL MODELS

Year

2005-

SS1310
Outer Tie Rod End Set
(Ø16*Ø18.1/M16*1.5)



SS1010
Outer Tie Rod End
(Ø16*Ø18.1/M16*1.5)



SS1011
Outer Tie Rod End
(Ø16*Ø18.1/M16*1.5)



SS1510
Link Stabilizer
L=171



SS1511 / SS1512
Link Stabilizer
L=205



SS1610
Upper Ball Joint
(Ø17.6)



SS1610
Upper Ball Joint
(Ø17.6)



SS1810
Upper Control Arm Bush



SS1710
Upper Control Arm

SS1711
Upper Control Arm

SS1910
Lower Ball Joint
(Ø17.25)



SS1910
Lower Ball Joint
(Ø17.25)



SS2010
Lower Control Arm
4 WD



SS2011
Lower Control Arm
4 WD



LEFT

RIGHT

SSANGYONG

KORANDO.MUSSO FRONT

ALL MODELS

Year

1996-2005

SS1311
Outer Tie Rod End Set
(Ø16*Ø18.1/M14*1.5)



SS1312
Outer Tie Rod End Set
(Ø15.3*Ø13.63/M14*1.5)

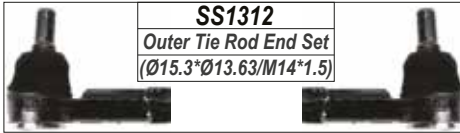

FI1418
Rack End
(16*1.5/14*1.5/283)



SS1012
Outer Tie Rod End
(Ø16*Ø18.1/M14*1.5)



SS1012
Outer Tie Rod End
(Ø16*Ø18.1/M14*1.5)



SS1013
Outer Tie Rod End
(Ø15.3*Ø13.63/M14*1.5)



SS1013
Outer Tie Rod End
(Ø15.3*Ø13.63/M14*1.5)



SS1510
Link Stabilizer
L=171



IS1610
Upper Ball Joint
(Ø17.6)



IS1610
Upper Ball Joint
(Ø17.6)



SS1911
Lower Ball Joint
(Ø17.55)



SS1911
Lower Ball Joint
(Ø17.55)



LEFT

RIGHT

SSANGYONG

KYRON.REXTON FRONT

ALL MODELS

Year

2005-

SS1310
Outer Tie Rod End Set
(Ø16*Ø18.1/M16*1.5)



SS1010
Outer Tie Rod End
(Ø16*Ø18.1/M16*1.5)



SS1410
Rack End
(16*1.5/14*1.5/283)



SS1011
Outer Tie Rod End
(Ø16*Ø18.1/M16*1.5)



SS1511 / SS1512
Link Stabilizer
L=205



SS1610
Upper Ball Joint
(Ø17.6)



SS1810
Upper Control Arm Bush

SS1610
Upper Ball Joint
(Ø17.6)



SS1710
Upper Control Arm

SS1711
Upper Control Arm

SS1910
Lower Ball Joint
(Ø17.25)



SS1910
Lower Ball Joint
(Ø17.25)



KYRON.REXTON REAR

SS1513 / SS1514
Link Stabilizer
L=205



LEFT

RIGHT

SUBARU

FORESTER

FRONT

SF

Year

1996-2002

SU1310
Outer Tie Rod End Set
(Ø12.9*Ø15.4/M14*1.5)

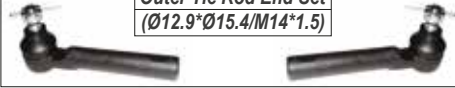

SU1010
Outer Tie Rod End
(Ø12.9*Ø15.4/M14*1.5)



SU1410
Rack End
(14*1.5 / 14*1.5/309)



SU1010
Outer Tie Rod End
(Ø12.9*Ø15.4/M14*1.5)



SU2112
Lower Control Arm Bush



SU1910
Lower Ball Joint
(Ø15.45)



SU2010
Lower Control Arm

SU2011
Lower Control Arm

SU1910
Lower Ball Joint
(Ø15.45)



SU2113 / SU2114
Lower Control Arm Bush



LEFT

RIGHT

SUBARU

FORESTER.OUTBACK FRONT

Year

2003-2008

SG

SU1310
Outer Tie Rod End Set
(Ø12.9*Ø15.4/M14*1.5)

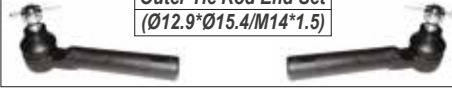

SU1010
Outer Tie Rod End
(Ø12.9*Ø15.4/M14*1.5)



SU1411
Rack End
(16*1.5 /14*1.5/302)



SU1010
Outer Tie Rod End
(Ø12.9*Ø15.4/M14*1.5)



SU1510
Link Stabilizer
L=60



SU2115
Lower Control Arm Bush



SU1910
Lower Ball Joint
(Ø15.45)



SU1910
Lower Ball Joint
(Ø15.45)



SU2012
Lower Control Arm



SU2013
Lower Control Arm



SU2116 / SU2117
Lower Control Arm Bush



FORESTER.OUTBACK REAR

SU1511
Link Stabilizer
L=70.5



LEFT

RIGHT

SUBARU

FORESTER.OUTBACK FRONT

SH

Year

2008-2013

SU1310
Outer Tie Rod End Set
(Ø12.9*Ø15.4/M14*1.5)

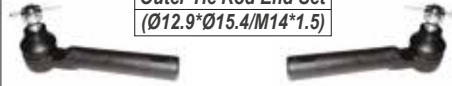

SU1010
Outer Tie Rod End
(Ø12.9*Ø15.4/M14*1.5)



SU1412
Rack End
(16*1.5/14*1.5/324)



SU1010
Outer Tie Rod End
(Ø12.9*Ø15.4/M14*1.5)



SU1510
Link Stabilizer
L=60



SU2118
Lower Control Arm Bush



SU1910
Lower Ball Joint
(Ø15.45)



SU2014
Lower Control Arm

SU2015
Lower Control Arm

SU1910
Lower Ball Joint
(Ø15.45)



SU2119
Lower Control Arm Bush



FORESTER.OUTBACK REAR

SU1511
Link Stabilizer
L=70.5



LEFT

RIGHT

SUBARU

IMPREZA.LEGACY

FRONT

GC

Year

1995-2001

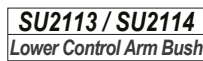
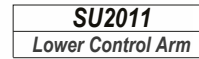
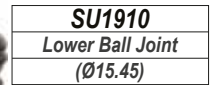
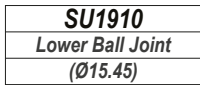
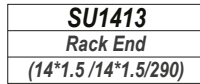
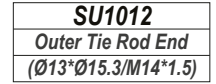
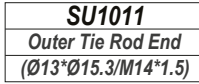
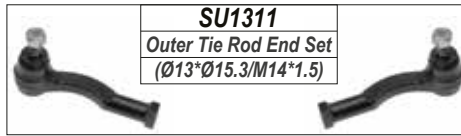

LEFT

RIGHT

SUBARU

IMPREZA.LEGACY

FRONT

GD

Year

2000-2007

SU1310
Outer Tie Rod End Set
(Ø12.9*Ø15.4/M14*1.5)

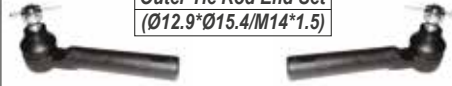

SU1010
Outer Tie Rod End
(Ø12.9*Ø15.4/M14*1.5)

SU1413
Rack End
(14*1.5/14*1.5/290)

SU1010
Outer Tie Rod End
(Ø12.9*Ø15.4/M14*1.5)



SU1414
Rack End
(14*1.5/14*1.5/300.5)

SU1510
Link Stabilizer
L=60



SU2112
Lower Control Arm Bush

SU1910
Lower Ball Joint
(Ø15.45)



SU1910
Lower Ball Joint
(Ø15.45)

SU2010
Lower Control Arm

SU2011
Lower Control Arm

SU2113 / SU2114
Lower Control Arm Bush

IMPREZA.LEGACY

REAR

SU1511
Link Stabilizer
L=70.5



LEFT

RIGHT

SUBARU

IMPREZA

FRONT

Year

GR

2007-2014

SU1310
Outer Tie Rod End Set
(Ø12.9*Ø15.4/M14*1.5)

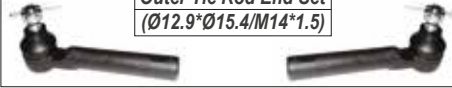

SU1010
Outer Tie Rod End
(Ø12.9*Ø15.4/M14*1.5)

SU1010
Outer Tie Rod End
(Ø12.9*Ø15.4/M14*1.5)

SU1414
Rack End
(14*1.5 /14*1.5/300.5)



SU1510
Link Stabilizer
L=60



SU2118
Lower Control Arm Bush

SU1910
Lower Ball Joint
(Ø15.45)

SU1910
Lower Ball Joint
(Ø15.45)



SU2016
Lower Control Arm

SU2017
Lower Control Arm



SU2119
Lower Control Arm Bush



IMPREZA

REAR

SU1512
Link Stabilizer
L=107.4



LEFT

RIGHT

SUZUKI

ALTO

FRONT

ALL MODELS

Year

2009-

SZ1310
Outer Tie Rod End Set
(Ø13*Ø15/M12*1.25)

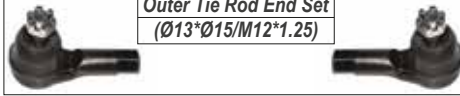

SZ1010
Outer Tie Rod End
(Ø13*Ø15/M12*1.25)

SZ1410
Rack End
(14*1.5/12*1.25/273)

SZ1010
Outer Tie Rod End
(Ø13*Ø15/M12*1.25)



SZ1510
Link Stabilizer
L=282



SZ2111
Lower Control Arm Bush

SZ1910
Lower Ball Joint
(Ø13.3)

SZ1910
Lower Ball Joint
(Ø13.3)



SZ2010
Lower Control Arm

SZ2011
Lower Control Arm

SZ2110
Lower Control Arm Bush

SZ2810
Shock Mounting

SZ2810
Shock Mounting



ALTO

REAR

SZ2610 / SZ2611
Lateral Link



LEFT

RIGHT

SUZUKI

BALENO

FRONT

ALL MODELS

Year

2015-

SZ1319

Outer Tie Rod End Set
(Ø12.9*Ø14.9/M14*1.5)

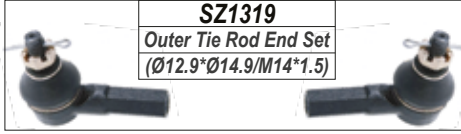

SZ1021

Outer Tie Rod End
(Ø12.9*Ø14.9/M14*1.5)



SZ1417

Rack End
(14*1.5/14*1.5/323)



SZ1022

Outer Tie Rod End
(Ø12.9*Ø14.9/M14*1.5)



SZ1517

Link Stabilizer
L=350



SZ2114

Lower Control Arm Bush

SZ1913

Lower Ball Joint
(Ø13.5)



SZ1913

Lower Ball Joint
(Ø13.5)



SZ2024

Lower Control Arm

SZ2025

Lower Control Arm

SZ2115

Lower Control Arm Bush

LEFT

RIGHT

SUZUKI

CIAZ

FRONT

ALL MODELS

Year

2016-

SZ1315
Outer Tie Rod End Set
(Ø13*Ø15/M14*1.5)

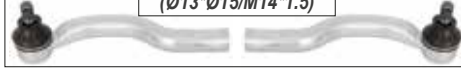

SZ1018
Outer Tie Rod End
(Ø13*Ø15/M14*1.5)



SZ1416
Rack End
(14*1.5/14*1.5/187)



SZ1019
Outer Tie Rod End
(Ø13*Ø15/M14*1.5)



SZ1516
Link Stabilizer
L=270



SZ1910
Lower Ball Joint
(Ø13.3)



SZ2118
Lower Control Arm Bush



SZ1910
Lower Ball Joint
(Ø13.3)



SZ2026
Lower Control Arm

SZ2027
Lower Control Arm

SZ2119
Lower Control Arm Bush



SZ2812
Shock Mounting



SZ2812
Shock Mounting



LEFT

RIGHT

SUZUKI

ERTIGA

FRONT

ALL MODELS

Year

2012-

SZ1315
Outer Tie Rod End Set
(Ø13*Ø15/M14*1.5)

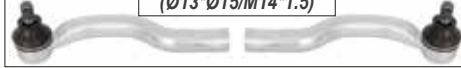

SZ1018
Outer Tie Rod End
(Ø13*Ø15/M14*1.5)



SZ1416
Rack End
(14*1.5/14*1.5/187)



SZ1019
Outer Tie Rod End
(Ø13*Ø15/M14*1.5)



SZ1516
Link Stabilizer
L=270



SZ1910
Lower Ball Joint
(Ø13.3)



SZ2118
Lower Control Arm Bush



SZ1910
Lower Ball Joint
(Ø13.3)



SZ2018
Lower Control Arm

SZ2019
Lower Control Arm

SZ2119
Lower Control Arm Bush



LEFT

RIGHT

SUZUKI

GRAND VITARA

FRONT

ALL MODELS

Year

1999-2008

SZ1311

Outer Tie Rod End Set
(Ø12.5*Ø14/M14*1.5)

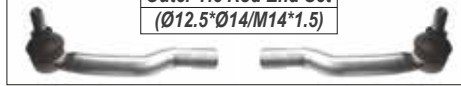

SZ1011

Outer Tie Rod End
(Ø12.5*Ø14/M14*1.5)



SZ1411

Rack End
(16*1.0 / 14*1.5/228)



SZ1012

Outer Tie Rod End
(Ø12.5*Ø14/M14*1.5)



SZ1511

Link Stabilizer
L=90



SZ2112

Lower Control Arm Bush



SZ2012

Lower Control Arm

SZ2013

Lower Control Arm

SZ2113

Lower Control Arm Bush

LEFT

RIGHT

SUZUKI

GRAND VITARA

FRONT

ALL MODELS

Year

2008-

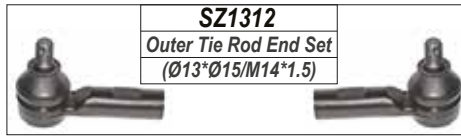

SZ1312
Outer Tie Rod End Set
($\varnothing 13^* \varnothing 15 / M14^* 1.5$)

SZ1013
Outer Tie Rod End
($\varnothing 13^* \varnothing 15 / M14^* 1.5$)

SZ1412
Rack End
($18^* 1.5 / 14^* 1.5 / 344$)

SZ1013
Outer Tie Rod End
($\varnothing 13^* \varnothing 15 / M14^* 1.5$)



SZ1512
Link Stabilizer
L=300.5



SZ2014
Lower Control Arm

SZ2015
Lower Control Arm

LEFT

RIGHT

SUZUKI

JIMNY

FRONT

ALL MODELS

Year

1998-

SZ1313

Outer Tie Rod End Set
(Ø12.5*Ø14/M16*1.5)

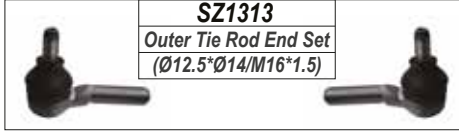

SZ1014

Outer Tie Rod End
(Ø12.5*Ø14/M16*1.5)



SZ1015

Outer Tie Rod End
(Ø12.5*Ø14/M16*1.5)



SZ1513

Link Stabilizer
L=93



SZ1514

Link Stabilizer
L=111.5



LEFT

RIGHT

SUZUKI
SWIFT
FRONT
ALL MODELS

Year

2008-2012

SZ1016
Outer Tie Rod End
(Ø12.5*Ø14.1/M12*1.25)

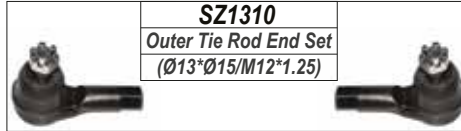
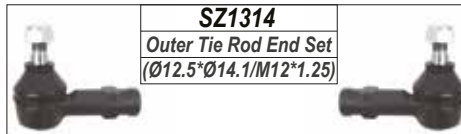

SZ1016
Outer Tie Rod End
(Ø12.5*Ø14.1/M12*1.25)



SZ1010
Outer Tie Rod End
(Ø13*Ø15/M12*1.25)



SZ1010
Outer Tie Rod End
(Ø13*Ø15/M12*1.25)



SZ1413
Rack End
(18*1.5 / 12*1.25/305)

SZ1515
Link Stabilizer
L=300



SZ1911
Lower Ball Joint
(Ø15)



SZ2116
Lower Control Arm Bush



SZ1911
Lower Ball Joint
(Ø15)



SZ2016
Lower Control Arm

SZ2017
Lower Control Arm

SZ2811
Shock Mounting



SZ2117
Lower Control Arm Bush



SZ2811
Shock Mounting

LEFT
RIGHT

SUZUKI

SWIFT

FRONT

ALL MODELS

Year

2011-

SZ1315
Outer Tie Rod End Set
(Ø13.1*Ø15.5/M14*1.5)

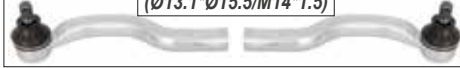

SZ1018
Outer Tie Rod End
(Ø13.1*Ø15.5/M14*1.5)



SZ1414
Rack End
(18*1.5/14*1.5/187)



SZ1019
Outer Tie Rod End
(Ø13.1*Ø15.5/M14*1.5)



SZ1516
Link Stabilizer
L=270



SZ1910
Lower Ball Joint
(Ø13.3)



SZ2118
Lower Control Arm Bush



SZ1910
Lower Ball Joint
(Ø13.3)



SZ2018
Lower Control Arm

SZ2019
Lower Control Arm

SZ2119
Lower Control Arm Bush



SZ2812
Shock Mounting



SZ2812
Shock Mounting



LEFT

RIGHT

SUZUKI

SX4

FRONT

ALL MODELS

Year

2008-

SZ1020
Outer Tie Rod End
(Ø13*Ø15/M14*1.5)



SZ1013
Outer Tie Rod End
(Ø13*Ø15/M14*1.5)

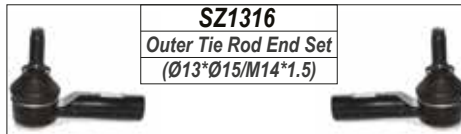

SZ1316
Outer Tie Rod End Set
(Ø13*Ø15/M14*1.5)

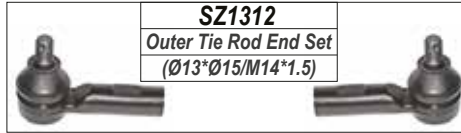

SZ1312
Outer Tie Rod End Set
(Ø13*Ø15/M14*1.5)

SZ1415
Rack End
(16*1.0/14*1.5/352.5)

SZ1020
Outer Tie Rod End
(Ø13*Ø15/M14*1.5)



SZ1013
Outer Tie Rod End
(Ø13*Ø15/M14*1.5)



SZ1516
Link Stabilizer
L=270



SZ2118
Lower Control Arm Bush



SZ2020
Lower Control Arm

SZ2021
Lower Control Arm

SZ2119
Lower Control Arm Bush



LEFT

RIGHT

SUZUKI

VITARA

FRONT

ALL MODELS

Year

1988-1998

SZ2210

Center Rod



SZ1317

Outer Tie Rod End Set
(Ø13*Ø15/M14*1.5)



SZ1318

Inner Tie Rod End Set
(Ø13*Ø15/M14*1.5)

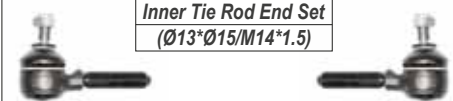

SZ1017

Outer Tie Rod End
(Ø13*Ø15/M14*1.5)



SZ1110

Inner Tie Rod End
(Ø13*Ø15/M14*1.5)



SZ1017

Outer Tie Rod End
(Ø13*Ø15/M14*1.5)



SZ1912

Lower Ball Joint
(Ø16)



SZ1912

Lower Ball Joint
(Ø16)



SZ2022

Lower Control Arm

SZ2023

Lower Control Arm

LEFT

RIGHT

TATA

BOLT

FRONT

ALL MODELS

Year

2015-

TA1310
Outer Tie Rod End Set

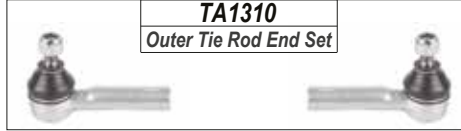

TA1010
Outer Tie Rod End



TA1410
Rack End
(14*1.5/14*1.5/235)



TA1011
Outer Tie Rod End



TA1512
Link Stabilizer
L=260



TA1912
Lower Ball Joint



TA1912
Lower Ball Joint



TA2010
Lower Control Arm



TA2011
Lower Control Arm



LEFT

RIGHT

TATA

INDIGO.INDICA

FRONT

ALL MODELS

Year

2005-

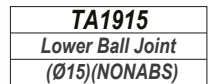
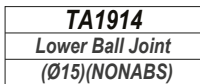
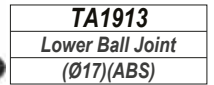
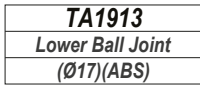
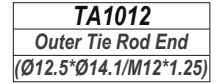
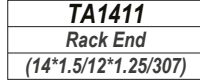
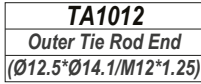
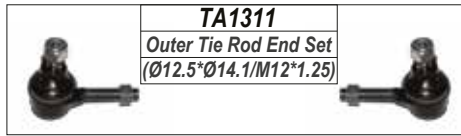

LEFT

RIGHT

TATA

TELCOLINE.WORKER FRONT

ALL MODELS

Year

2004-

TA2210

Center Rod

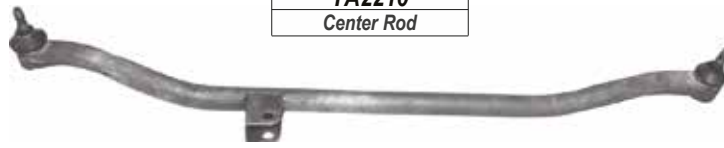

TA1312

Outer Tie Rod End Set
(Ø14.4*Ø16.4/M16*1.5)

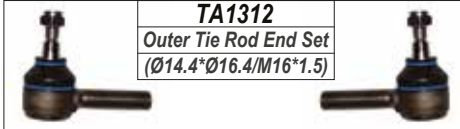

TA1313

Inner Tie Rod End Set
(Ø14.67*Ø16.5/M16*1.5)

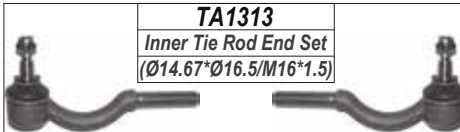

TA1013

Outer Tie Rod End
(Ø14.4*Ø16.4/M16*1.5)



TA1110 / TA1111

Inner Tie Rod End
(Ø14.67*Ø16.5/M16*1.5)



TA1014

Outer Tie Rod End
(Ø14.4*Ø16.4/M16*1.5)



TA1210 / TA1211

Tie Rod Assembly



TA1610

Upper Ball Joint
(Ø18.35)



TA1610

Upper Ball Joint
(Ø18.35)



TA1910

Lower Ball Joint
(Ø20.35)



TA1910

Lower Ball Joint
(Ø20.35)



TA1911

Lower Ball Joint
(Ø20.35)



TA1911

Lower Ball Joint
(Ø20.35)



LEFT

RIGHT

TATA

XENON

FRONT

ALL MODELS

Year

2008-

TA2310

Drag Link



TA1314

*Inner/Outer Tie Rod End Set
(Ø14.3*Ø16.5/M16*1.5)*

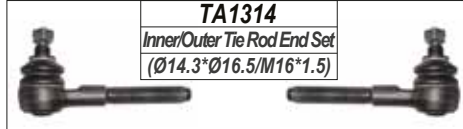

TA1112

*Outer Tie Rod End
(Ø14.3*Ø16.5/M16*1.5)*



TA1112 / TA1113

*Inner Tie Rod End
(Ø14.3*Ø16.5/M16*1.5)*



TA1113

*Outer Tie Rod End
(Ø14.3*Ø16.5/M16*1.5)*



TA1212

Tie Rod Assembly



TA1511

*Link Stabilizer
L=126*



TA1610

*Upper Ball Joint
(Ø18.35)*



TA1610

*Upper Ball Joint
(Ø18.35)*



TA1911

*Lower Ball Joint
(Ø20.35)*



TA1911

*Lower Ball Joint
(Ø20.35)*



LEFT

RIGHT

TOYOTA

86

FRONT

ALL MODELS

Year

2012-

TO1310
Outer Tie Rod End Set
(Ø13.09*Ø15.4/M14*1.5)

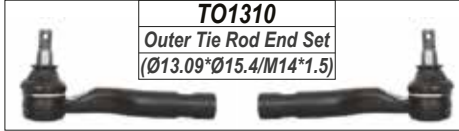

TO1029
Outer Tie Rod End
(Ø13.09*Ø15.4/M14*1.5)



TO1411
Rack End
(16*1.5/14*1.5/226)



TO1030
Outer Tie Rod End
(Ø13.09*Ø15.4/M14*1.5)



TO1510
Link Stabilizer
L=245



SU2118
Lower Control Arm Bush



TO1917
Lower Ball Joint
(Ø17.5)



TO1917
Lower Ball Joint
(Ø17.5)



TO2010
Lower Control Arm

TO2011
Lower Control Arm

SU2119
Lower Control Arm Bush



86

REAR

SU1512
Link Stabilizer
L=107.4



LEFT

RIGHT

TOYOTA

AURIS

FRONT

ALL MODELS

Year

2007-

TO1311
Outer Tie Rod End Set
(Ø13.6*Ø16.1/M15*1.5)



TO1010
Outer Tie Rod End
(Ø13.6*Ø16.1/M15*1.5)



TO1412
Rack End
(14*1.5/15*1.5/233)



TO1011
Outer Tie Rod End
(Ø13.6*Ø16.1/M15*1.5)



TO1511
Link Stabilizer
L=360



TO2111
Lower Control Arm Bush



TO1918
Lower Ball Joint
(Ø17.5)



TO1918
Lower Ball Joint
(Ø17.5)



TO2012
Lower Control Arm



TO2013
Lower Control Arm



TO2811
Shock Mounting



TO2110
Lower Control Arm Bush



TO2811
Shock Mounting



AURIS

REAR

TO1512
Link Stabilizer
L=107.4



LEFT

RIGHT

TOYOTA

AVANZA

FRONT

ALL MODELS

Year

2006-2011

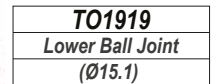
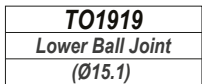
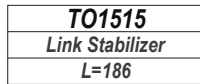
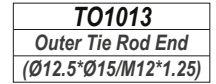
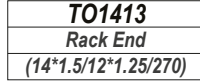
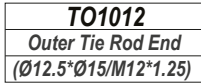
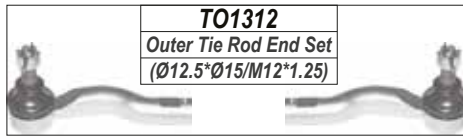

LEFT

RIGHT

TOYOTA

AVANZA

FRONT

ALL MODELS

Year

2011-

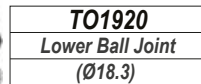
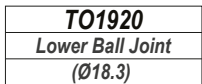
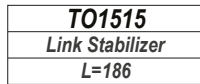
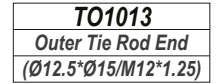
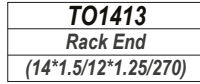
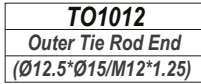
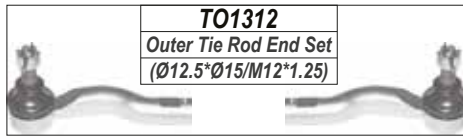

LEFT

RIGHT

TOYOTA

AVENSIS

FRONT

ALL MODELS

Year

2006-2009

TO1014
Outer Tie Rod End
(Ø12.5*Ø15/M16*1.5)

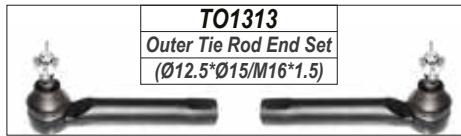

TO1313
Outer Tie Rod End Set
(Ø12.5*Ø15/M16*1.5)

TO1414
Rack End
(14*1.5/16*1.5/304)

TO1014
Outer Tie Rod End
(Ø12.5*Ø15/M16*1.5)

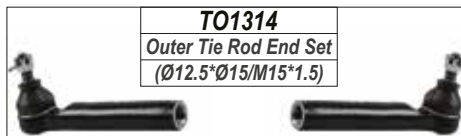

TO1314
Outer Tie Rod End Set
(Ø12.5*Ø15/M15*1.5)

TO1015
Outer Tie Rod End
(Ø12.5*Ø15/M15*1.5)



TO1415
Rack End
(14*1.5/15*1.5/369)



TO1015
Outer Tie Rod End
(Ø12.5*Ø15/M15*1.5)



NI1542
Link Stabilizer
L=285



TO1921
Lower Ball Joint
(Ø17.2)



TO1921
Lower Ball Joint
(Ø17.2)



TO2112
Lower Control Arm Bush



TO1922
Lower Ball Joint
(Ø15)



TO1922
Lower Ball Joint
(Ø15)



TO2018
Lower Control Arm



TO2019
Lower Control Arm



TO2813
Shock Mounting

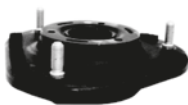

TO2813
Shock Mounting



TO2113
Lower Control Arm Bush



AVENSIS

REAR

TO1513 / TO1514
Link Stabilizer
L=100



LEFT

RIGHT

TOYOTA

AYGO

FRONT

ALL MODELS

Year

2011-

CI1013
Outer Tie Rod End
(Ø12.5*Ø15/M12*1.25)

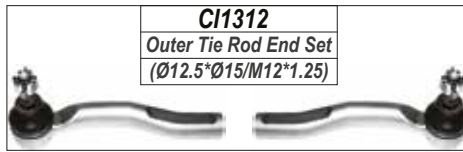

CI1312
Outer Tie Rod End Set
(Ø12.5*Ø15/M12*1.25)

CI1014
Outer Tie Rod End
(Ø12.5*Ø15/M12*1.25)



CI1412
Rack End
(14*1.5/12*1.25/222)



CI1512
Link Stabilizer
L=92



CI2114
Lower Control Arm Bush



CI1913
Lower Ball Joint
(Ø13.5)



CI1913
Lower Ball Joint
(Ø13.5)



CI2014
Lower Control Arm



CI2015
Lower Control Arm

CI2115
Lower Control Arm Bush



CI2812
Shock Mounting



CI2812
Shock Mounting



LEFT

RIGHT

TOYOTA

CAMRY

FRONT

ALL MODELS

Year

1992-2001

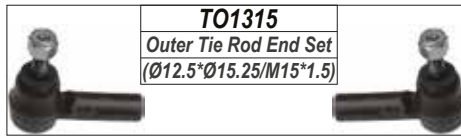

TO1315
Outer Tie Rod End Set
(Ø12.5*Ø15.25/M15*1.5)

TO1016
Outer Tie Rod End
(Ø12.5*Ø15.25/M15*1.5)

TO1416
Rack End
(14*1.5/15*1.5/336)

TO1016
Outer Tie Rod End
(Ø12.5*Ø15.25/M15*1.5)



TO1516
Link Stabilizer
L=60



TO1517 / TO1518
Link Stabilizer
L=285



TO2115
Lower Control Arm Bush



TO1923
Lower Ball Joint
(Ø17.5)



TO1923
Lower Ball Joint
(Ø17.5)



TO2020
Lower Control Arm

TO2021
Lower Control Arm

TO2814
Shock Mounting



TO2814
Shock Mounting



TO2114
Lower Control Arm Bush

CAMRY

REAR

TO1519
Link Stabilizer
L=195



TO1520
Link Stabilizer
L=70



LEFT

RIGHT

TOYOTA

CAMRY

FRONT

ALL MODELS

Year

2001-

TO1316
Outer Tie Rod End Set
(Ø12.5*Ø15/M15*1.5)

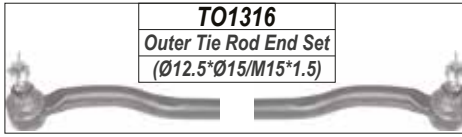

TO1017
Outer Tie Rod End
(Ø12.5*Ø15/M15*1.5)

TO1416
Rack End
(14*1.5/15*1.5/336)

TO1018
Outer Tie Rod End
(Ø12.5*Ø15/M15*1.5)



TO1317
Outer Tie Rod End Set
(Ø13.5*Ø16/M15*1.5)

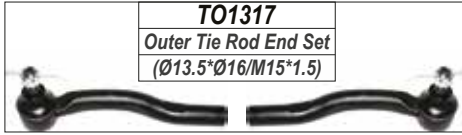

TO1019
Outer Tie Rod End
(Ø13.5*Ø16/M15*1.5)

TO1417
Rack End
(14*1.5/15*1.5/238)

TO1020
Outer Tie Rod End
(Ø13.5*Ø16/M15*1.5)

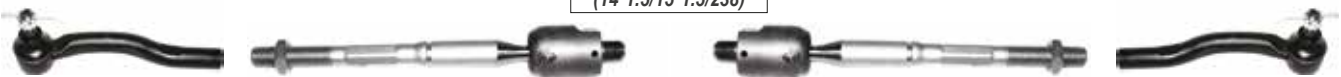

TO1521
Link Stabilizer
L=260



TO1522
Link Stabilizer
L=260

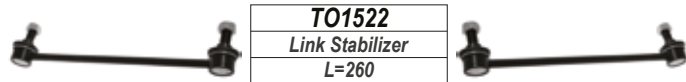

TO1924
Lower Ball Joint
(Ø17.5)



TO1925
Lower Ball Joint
(Ø17.5)

TO2116
Lower Control Arm Bush



TO2022
Lower Control Arm

TO2023
Lower Control Arm

TO1940
Lower Ball Joint
(Ø15).8



TO1941
Lower Ball Joint
(Ø15.8)

TO2116
Lower Control Arm Bush



TO2024
Lower Control Arm
Import Only

TO2025
Lower Control Arm
Import Only

TO2815
Shock Mounting



TO2815
Shock Mounting



CAMRY

REAR

TO1523
Link Stabilizer
L=237

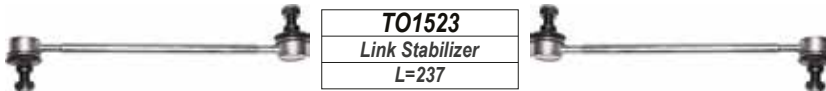

LEFT

RIGHT

TOYOTA

CH-R

FRONT

ALL MODELS

Year

2017-

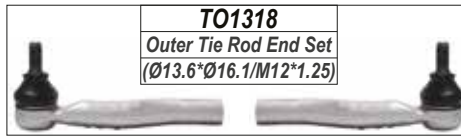

TO1031	
<i>Outer Tie Rod End</i>	
<i>(Ø13.6*Ø16.1/M12*1.25)</i>	



TO1032	
<i>Outer Tie Rod End</i>	
<i>(Ø13.6*Ø16.1/M12*1.25)</i>	



TO1524	
<i>Link Stabilizer</i>	
<i>L=330</i>	



TO1918	
<i>Lower Ball Joint</i>	
<i>(Ø17.5)</i>	



TO2026	
<i>Lower Control Arm</i>	

TO2027	
<i>Lower Control Arm</i>	

TO1918	
<i>Lower Ball Joint</i>	
<i>(Ø17.5)</i>	



TO2810	
<i>Stabilizer Bar Bush</i>	



LEFT

RIGHT

TOYOTA

**CONDOR FRONT
STALLION, VENTURE**

4X2

Year

2000-2005

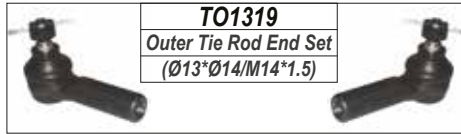

TO1319
Outer Tie Rod End Set
(Ø13*Ø14/M14*1.5)

TO1033
Outer Tie Rod End
(Ø13*Ø14/M14*1.5)



TO1418
Rack End
(14*1.5/14*1.5/315)



TO1033
Outer Tie Rod End
(Ø13*Ø14/M14*1.5)



TO1611
Upper Ball Joint
(Ø15.4)



TO1710
Upper Control Arm
48067-28060

TO1711
Upper Control Arm
48067-28060



TO1611
Upper Ball Joint
(Ø15.4)

FT1910
Lower Ball Joint
(Ø17)



TO2028
Lower Control Arm
48069-28070

TO2029
Lower Control Arm
48069-28070

FT1910
Lower Ball Joint
(Ø17)



LEFT

RIGHT

TOYOTA

CONDOR

FRONT

4X4

Year

2000-2005

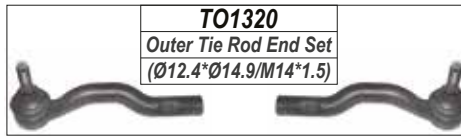

TO1320
Outer Tie Rod End Set
(Ø12.4*Ø14.9/M14*1.5)

TO1021
Outer Tie Rod End
(Ø12.4*Ø14.9/M14*1.5)



FT1410
Rack End
(14*1.5/14*1.5/296)



TO1022
Outer Tie Rod End
(Ø12.4*Ø14.9/M14*1.5)



TO1525
Link Stabilizer
L=



TO1612
Upper Ball Joint



TO1612
Upper Ball Joint



TO1712
Upper Control Arm
48067-29135

TO1713
Upper Control Arm
48067-29135

TO1910
Lower Ball Joint
(Ø18)



TO1910
Lower Ball Joint
(Ø18)



TO2030
Lower Control Arm
48069-28090



TO2031
Lower Control Arm
48069-28090



LEFT

RIGHT

TOYOTA

CONQUEST

FRONT

EE80.AE82

Year

1984-1988

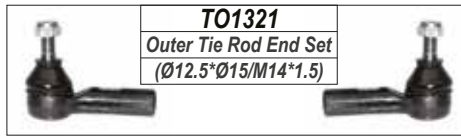

TO1321
Outer Tie Rod End Set
(Ø12.5*Ø15/M14*1.5)

TO1034
Outer Tie Rod End
(Ø12.5*Ø15/M14*1.5)

TO1418
Rack End
(14*1.5/14*1.5/315)

TO1034
Outer Tie Rod End
(Ø12.5*Ø15/M14*1.5)



TO1911
Lower Ball Joint
(Ø16)

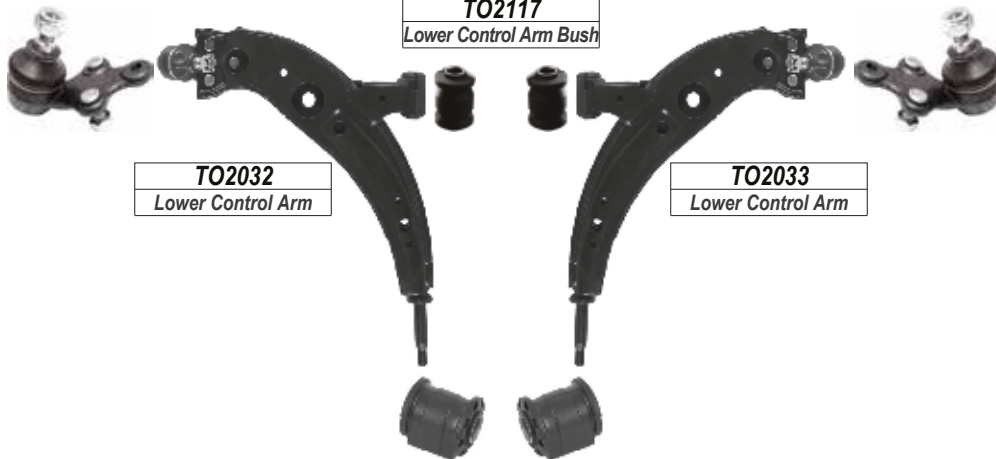

TO2117
Lower Control Arm Bush

TO1911
Lower Ball Joint
(Ø16)

TO2032
Lower Control Arm

TO2033
Lower Control Arm

TO2137
Lower Control Arm Bush

CONQUEST

REAR

TO2140
Lower Control Arm Bush



LEFT

RIGHT

TOYOTA

CONQUEST.TAZZ FRONT

EE90.AE92.AE93

Year

1988-2006

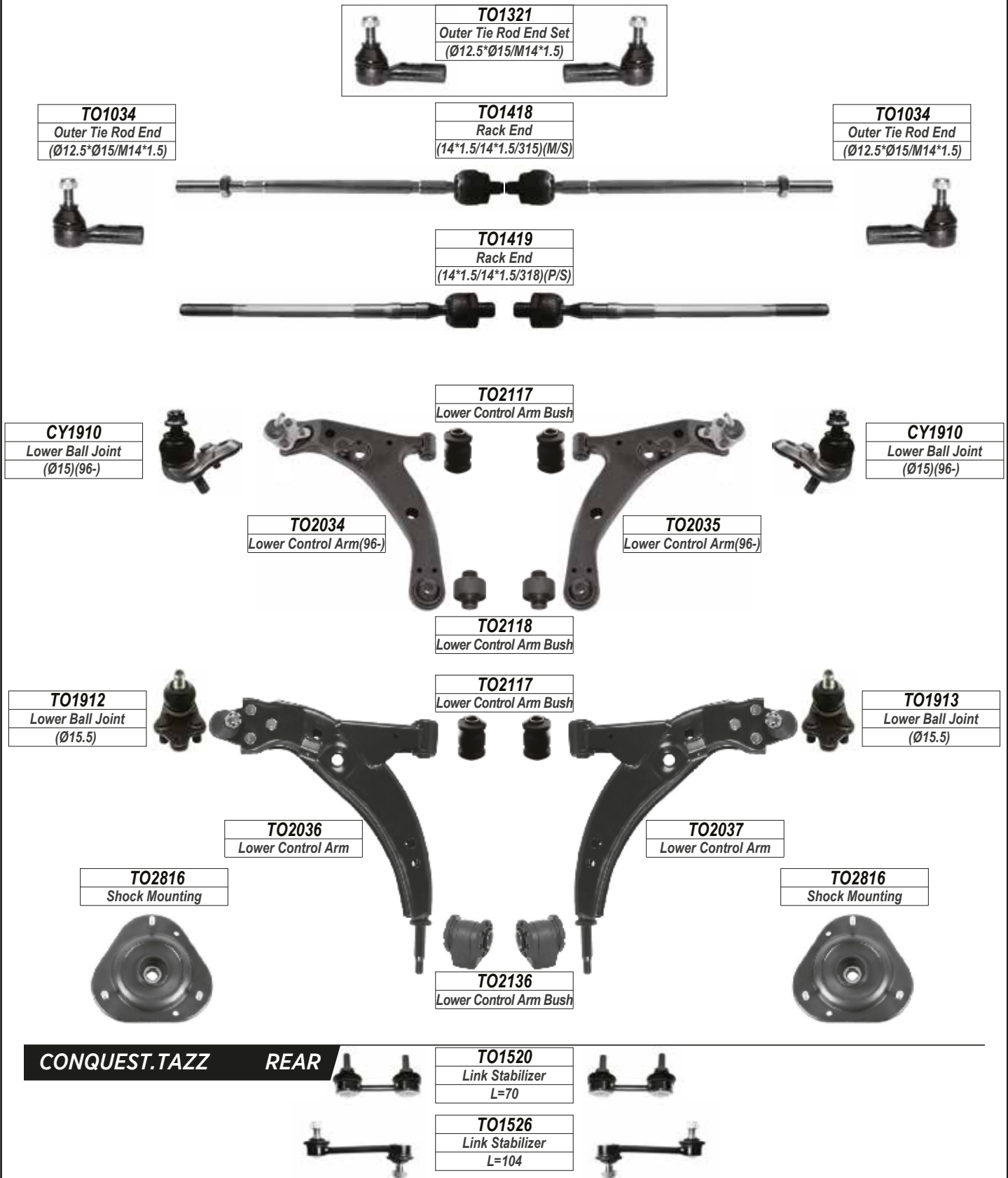

TO1321
Outer Tie Rod End Set
(Ø12.5*Ø15/M14*1.5)

TO1034
Outer Tie Rod End
(Ø12.5*Ø15/M14*1.5)

TO1418
Rack End
(14*1.5/14*1.5/315)(M/S)

TO1034
Outer Tie Rod End
(Ø12.5*Ø15/M14*1.5)

TO1419
Rack End
(14*1.5/14*1.5/318)(P/S)

TO2117
Lower Control Arm Bush

CY1910
Lower Ball Joint
(Ø15)(96-)

CY1910
Lower Ball Joint
(Ø15)(96-)

TO2034
Lower Control Arm(96-)

TO2035
Lower Control Arm(96-)

TO2118
Lower Control Arm Bush

TO1912
Lower Ball Joint
(Ø15.5)

TO2117
Lower Control Arm Bush

TO1913
Lower Ball Joint
(Ø15.5)

TO2036
Lower Control Arm

TO2037
Lower Control Arm

TO2816
Shock Mounting

TO2816
Shock Mounting

TO2136
Lower Control Arm Bush

CONQUEST.TAZZ REAR

TO1520
Link Stabilizer
L=70

TO1526
Link Stabilizer
L=104

LEFT

RIGHT

TOYOTA

COROLLA

FRONT

KE30.KE70.TE71

Year

1975-1989

TO1322
Outer Tie Rod End Set
(Ø13*Ø14/M14*1.5)

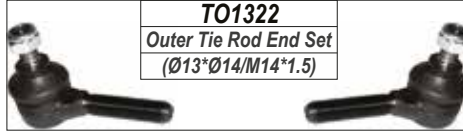

TO1345
Inner Tie Rod End Set
(Ø12.8*Ø14/M14*1.5)

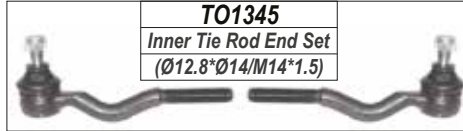

TO1119
Inner Tie Rod End
(Ø12.8*Ø14/M14*1.5)



TO1035
Outer Tie Rod End
(Ø13*Ø14/M14*1.5)



TO1035
Outer Tie Rod End
(Ø13*Ø14/M14*1.5)



TO1346
Outer Tie Rod End Set
(Ø12.8*Ø14/M14*1.5)



TO1036
Outer Tie Rod End
(Ø12.8*Ø14/M14*1.5)



TO1420
Rack End
(14*1.5/14*1.5/145)



TO1036
Outer Tie Rod End
(Ø12.8*Ø14/M14*1.5)



TO1914
Lower Ball Joint
(Ø14.67)



TO1914
Lower Ball Joint
(Ø14.67)



LEFT

RIGHT

TOYOTA

COROLLA

FRONT

EE80.AE82

Year

1984-1988

TO1321
Outer Tie Rod End Set
(Ø12.5*Ø15/M14*1.5)

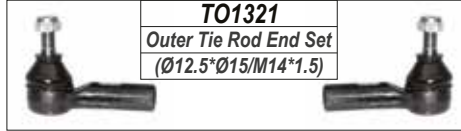

TO1034
Outer Tie Rod End
(Ø12.5*Ø15/M14*1.5)

TO1418
Rack End
(14*1.5/14*1.5/315)

TO1034
Outer Tie Rod End
(Ø12.5*Ø15/M14*1.5)



TO1911
Lower Ball Joint
(Ø16)

TO2117
Lower Control Arm Bush

TO1911
Lower Ball Joint
(Ø16)



TO2032
Lower Control Arm

TO2033
Lower Control Arm

TO2137
Lower Control Arm Bush



TO2817
Shock Mounting



TO2817
Shock Mounting



COROLLA

REAR

TO2140
Lower Control Arm Bush



LEFT

RIGHT

TOYOTA

COROLLA

FRONT

EE90.AE92.AE93

Year

1988-1996

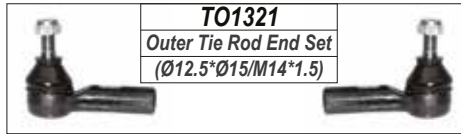

TO1321
Outer Tie Rod End Set
(Ø12.5*Ø15/M14*1.5)

TO1034
Outer Tie Rod End
(Ø12.5*Ø15/M14*1.5)

TO1418
Rack End
(14*1.5/14*1.5/315)(M/S)

TO1034
Outer Tie Rod End
(Ø12.5*Ø15/M14*1.5)



TO1419
Rack End
(14*1.5/14*1.5/318)(P/S)



TO1516
Link Stabilizer
L=60



TO1912
Lower Ball Joint
(Ø15.5)



TO2117
Lower Control Arm Bush



TO1913
Lower Ball Joint
(Ø15.5)



TO2036
Lower Control Arm



TO2037
Lower Control Arm



TO2816
Shock Mounting



TO2136
Lower Control Arm Bush



TO2816
Shock Mounting



COROLLA

REAR

TO1526
Link Stabilizer
L=104



LEFT

RIGHT

TOYOTA

**COROLLA
(RSI SHAPE)**

FRONT

EE110.AE111.AE112

Year

1996-2002

TO1034
Outer Tie Rod End
(Ø12.5*Ø15/M14*1.5)

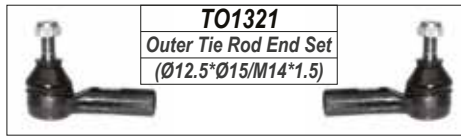

TO1321
Outer Tie Rod End Set
(Ø12.5*Ø15/M14*1.5)

TO1418
Rack End
(14*1.5/14*1.5/315)(M/S)

TO1034
Outer Tie Rod End
(Ø12.5*Ø15/M14*1.5)



TO1419
Rack End
(14*1.5/14*1.5/318)(P/S)



TO1421
Rack End
(14*1.5/14*1.5/329)(M/S)



TO1527
Link Stabilizer
L=55



TO2117
Lower Control Arm Bush



CY1910
Lower Ball Joint
(Ø15)



TO2034
Lower Control Arm

TO2035
Lower Control Arm

CY1910
Lower Ball Joint
(Ø15)



TO2118
Lower Control Arm Bush



TO2818
Shock Mounting



TO2818
Shock Mounting



**COROLLA
(RSI SHAPE)**

REAR

TO1526
Link Stabilizer
L=104



LEFT

RIGHT

TOYOTA

COROLLA RUNX

FRONT

F11.KS1.GF2

Year

2002-2008

TO1323
Outer Tie Rod End Set
(Ø12.55*Ø15/M14*1.5)

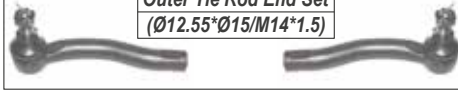

TO1037
Outer Tie Rod End
(Ø12.55*Ø15/M14*1.5)



TO1422
Rack End
(14*1.5/14*1.5/274)



TO1038
Outer Tie Rod End
(Ø12.55*Ø15/M14*1.5)



TO1528
Link Stabilizer
L=285



NI1542
Link Stabilizer
L=285



TO2112
Lower Control Arm Bush



CY1910
Lower Ball Joint
(Ø15)



CY1910
Lower Ball Joint
(Ø15)



TO2018
Lower Control Arm



TO2019
Lower Control Arm



TO2113
Lower Control Arm Bush



TO2819
Shock Mounting



TO2819
Shock Mounting



COROLLA RUNX

REAR

TO1513 / TO1514
Link Stabilizer
L=100



LEFT

RIGHT

TOYOTA

**COROLLA FRONT
PROFESSIONAL / QUEST**

ALL MODELS

Year

2008-

TO1039
Outer Tie Rod End
(Ø12.5*Ø15/M16*1.5)

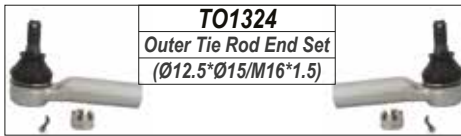

TO1324
Outer Tie Rod End Set
(Ø12.5*Ø15/M16*1.5)

TO1414
Rack End
(14*1.5/16*1.5/304)



TO1039
Outer Tie Rod End
(Ø12.5*Ø15/M16*1.5)

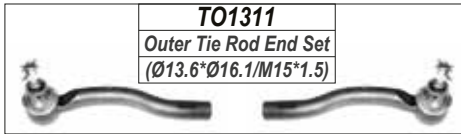

TO1311
Outer Tie Rod End Set
(Ø13.6*Ø16.1/M15*1.5)

TO1010
Outer Tie Rod End
(Ø13.6*Ø16.1/M15*1.5)



TO1412
Rack End
(14*1.5/15*1.5/233)



TO1011
Outer Tie Rod End
(Ø13.6*Ø16.1/M15*1.5)



TO1511
Link Stabilizer
L=360



TO2111
Lower Control Arm Bush



TO1918
Lower Ball Joint
(Ø17.5)



TO1918
Lower Ball Joint
(Ø17.5)



TO2012
Lower Control Arm

TO2013
Lower Control Arm

TO2811
Shock Mounting

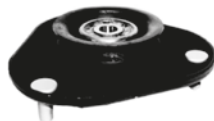

TO2811
Shock Mounting

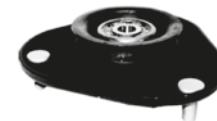

TO2110
Lower Control Arm Bush



**COROLLA REAR
PROFESSIONAL / QUEST**

TO1512
Link Stabilizer
L=107.4



LEFT

RIGHT

TOYOTA

COROLLA(VERSO) FRONT

ALL MODELS

Year

2004-2009

TO1313
Outer Tie Rod End Set
(Ø12.5*Ø15/M16*1.5)

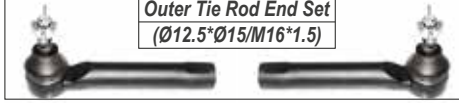

TO1014
Outer Tie Rod End
(Ø12.5*Ø15/M16*1.5)

TO1414
Rack End
(14*1.5/16*1.5/304)

TO1014
Outer Tie Rod End
(Ø12.5*Ø15/M16*1.5)



NI1542
Link Stabilizer
L=285



TO2112
Lower Control Arm Bush

CY1910
Lower Ball Joint
(Ø15)



CY1910
Lower Ball Joint
(Ø15)

TO2018
Lower Control Arm

TO2019
Lower Control Arm

TO2820
Shock Mounting



TO2113
Lower Control Arm Bush

TO2820
Shock Mounting



LEFT

RIGHT

TOYOTA

COROLLA(VERSO) FRONT

ALL MODELS

Year

2009-

TO1347
Outer Tie Rod End Set
(Ø12.25*Ø15/M16*1.5)

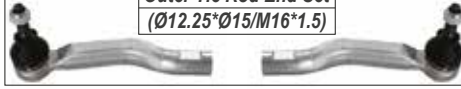

TO1057
Outer Tie Rod End
(Ø12.5*Ø15/M16*1.5)



TO1434
Rack End
(14*1.5/16*1.5/243)



TO1058
Outer Tie Rod End
(Ø12.5*Ø15/M16*1.5)



TO1511
Link Stabilizer
L=360



TO2111
Lower Control Arm Bush



TO1918
Lower Ball Joint
(Ø17.5)



TO1918
Lower Ball Joint
(Ø17.5)



TO2012
Lower Control Arm



TO2013
Lower Control Arm



TO2110
Lower Control Arm Bush



TO2831
Shock Mounting



TO2831
Shock Mounting



LEFT

RIGHT

TOYOTA

CRESSIDA

FRONT

ALL MODELS

Year

1986-

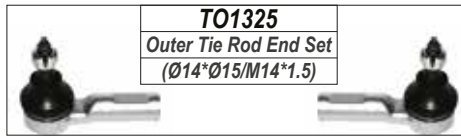

TO1325
Outer Tie Rod End Set
(Ø14*Ø15/M14*1.5)

TO1023
Outer Tie Rod End Set
(Ø14*Ø15/M14*1.5)



TO1023
Outer Tie Rod End Set
(Ø14*Ø15/M14*1.5)



TO1926
Lower Ball Joint
(Ø15.7)



TO2038
Lower Control Arm



TO2039
Lower Control Arm

TO1926
Lower Ball Joint
(Ø15.7)



LEFT

RIGHT

TOYOTA

ETIOS

FRONT

ALL MODELS

Year

2012-

TO1326
Outer Tie Rod End Set
($\varnothing 12.5 \times \varnothing 15 / M12 \times 1.25$)

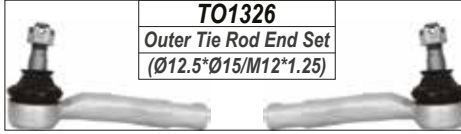

TO1024
Outer Tie Rod End
($\varnothing 12.5 \times \varnothing 15 / M12 \times 1.25$)



TO1410
Rack End
($14 \times 1.5 / 12 \times 1.25 / 270$)



TO1025
Outer Tie Rod End
($\varnothing 12.5 \times \varnothing 15 / M12 \times 1.25$)



TO1529
Link Stabilizer
L=92



TO2119
Lower Control Arm Bush

TO1927
Lower Ball Joint
($\varnothing 13.4$)



TO2040
Lower Control Arm

TO2041
Lower Control Arm

TO1927
Lower Ball Joint
($\varnothing 13.4$)



TO2120
Lower Control Arm Bush

TO2821
Shock Mounting



TO2821
Shock Mounting



LEFT

RIGHT

TOYOTA

FJ CRUISER

FRONT

ALL MODELS

Year

2011-

TO1327
Outer Tie Rod End Set
(Ø15.3*Ø17/M16*1.5)

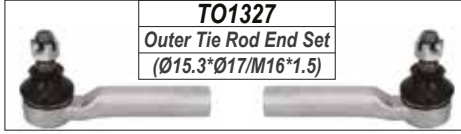

TO1040
Outer Tie Rod End
(Ø15.3*Ø17/M16*1.5)

TO1423
Rack End
(22*1.5/15*1.5/285.5)

TO1040
Outer Tie Rod End
(Ø15.3*Ø17/M16*1.5)



TO1530 / TO1531
Link Stabilizer
L=140



TO1610
Upper Ball Joint
(Ø15.8)



TO1810
Upper Control Arm Bush

TO1610
Upper Ball Joint
(Ø15.8)



TO1714
Upper Control Arm

TO1715
Upper Control Arm

TO1928
Lower Ball Joint
(Ø17.4)



TO1928
Lower Ball Joint
(Ø17.4)



TO2042
Lower Control Arm

TO2043
Lower Control Arm

FJ CRUISER

REAR

TO1545
Link Stabilizer
L=173.5



LEFT

RIGHT

TOYOTA

FORTUNER

FRONT

ALL MODELS

Year

2006-2016

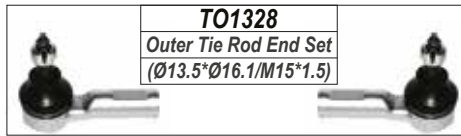

TO1328
Outer Tie Rod End Set
(Ø13.5*Ø16.1/M15*1.5)

TO1041
Outer Tie Rod End
(Ø13.5*Ø16.1/M15*1.5)

CY1411
Rack End
(14*1.5/15*1.5/298)

TO1041
Outer Tie Rod End
(Ø13.5*Ø16.1/M15*1.5)



TO1530 / TO1531
Link Stabilizer
L=140

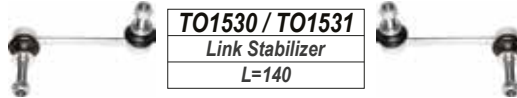

TO1613
Upper Ball Joint
(Ø15)



TO1811
Upper Control Arm Bush

TO1613
Upper Ball Joint
(Ø15)



TO1716
Upper Control Arm

TO1717
Upper Control Arm

TO2121
Lower Control Arm Bush

TO1915
Lower Ball Joint
(Ø16.7)



TO1915
Lower Ball Joint
(Ø16.7)



TO2044
Lower Control Arm

TO2045
Lower Control Arm

TO2122
Lower Control Arm Bush

TO2822
Shock Mounting



TO2822
Shock Mounting



TO2823
Shock Mounting



TO2823
Shock Mounting



LEFT

RIGHT

TOYOTA

FORTUNER

FRONT

ALL MODELS

Year

2016-

TO1028
Outer Tie Rod End
(Ø15.3*Ø17.1/M16*1.5)

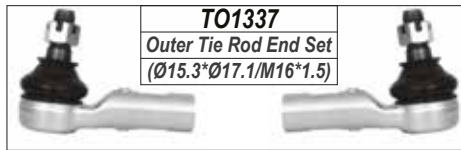

TO1337
Outer Tie Rod End Set
(Ø15.3*Ø17.1/M16*1.5)

TO1425
Rack End
(14*1.5/16*1.5/296)

TO1028
Outer Tie Rod End
(Ø15.3*Ø17.1/M16*1.5)



TO1530 / TO1531
Link Stabilizer
L=140



TO1613
Upper Ball Joint
(Ø15)



TO1811
Upper Control Arm Bush

TO1716
Upper Control Arm

TO1717
Upper Control Arm

TO1613
Upper Ball Joint
(Ø15)



TO1915
Lower Ball Joint
(Ø16.7)



TO2052
Lower Control Arm

TO2053
Lower Control Arm

TO1915
Lower Ball Joint
(Ø16.7)



LEFT

RIGHT

TOYOTA

HI-ACE

FRONT

RH11.RH20

Year

1969-1984

TO1026
Outer Tie Rod End
(Ø14.6*Ø16/M17*1.5)



TO1110
Inner Tie Rod End
(Ø15.4*Ø18.3/M14*1.5)



TO1026
Outer Tie Rod End
(Ø14.6*Ø16/M17*1.5)



TO1532 / TO1533
Link Stabilizer
L=73



TO1614
Upper Ball Joint
(Ø15)



TO1614
Upper Ball Joint
(Ø15)



TO1916
Lower Ball Joint
(Ø17.75)



TO1916
Lower Ball Joint
(Ø17.75)



LEFT

RIGHT

TOYOTA

HI-ACE

FRONT

YH50 / YH60

Year

1983-1992

TO2210

Center Rod



TO1331

Outer Tie Rod End Set
(Ø14.5*Ø16/M17*1.5)

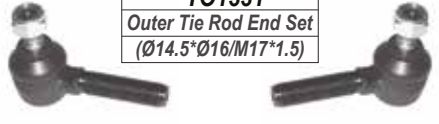

TO1332

Inner Tie Rod End Set
(Ø14.5*Ø16/M17*1.5)



TO1027

Outer Tie Rod End
(Ø14.5*Ø16/M17*1.5)



TO1111

Inner Tie Rod End
(Ø14.5*Ø16/M17*1.5)



TO1027

Outer Tie Rod End
(Ø14.5*Ø16/M17*1.5)



TO1534

Link Stabilizer
L=146



TO1615

Upper Ball Joint
(Ø17)



TO1615

Upper Ball Joint
(Ø17)



FT1910

Lower Ball Joint
(Ø16.8)



FT1910

Lower Ball Joint
(Ø16.8)



TO2130

Lower Control Arm Bush



CA1910

Lower Ball Joint
(Ø18)



CA2010

Lower Control Arm



CA2011

Lower Control Arm



CA1910

Lower Ball Joint
(Ø18)

LEFT

RIGHT

TOYOTA

HI-ACE

FRONT

YH53 / YH63

Year

1992-2008

CA1010
Outer Tie Rod End
(Ø14.6*Ø16.5/M17*1.5)

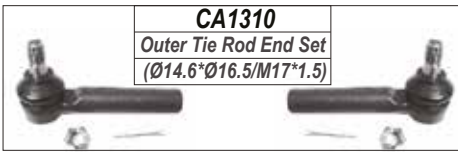

CA1310
Outer Tie Rod End Set
(Ø14.6*Ø16.5/M17*1.5)

CA1410
Rack End
(14*1.5/17*1.5/276)



CA1010
Outer Tie Rod End
(Ø14.6*Ø16.5/M17*1.5)



CA1011
Outer Tie Rod End
(Ø14.7*Ø16/M15*1.5)

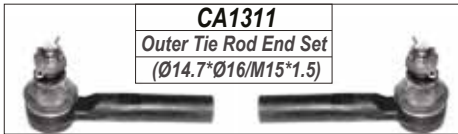

CA1311
Outer Tie Rod End Set
(Ø14.7*Ø16/M15*1.5)

CA1411
Rack End
(14*1.5/15*1.5/274)



CA1011
Outer Tie Rod End
(Ø14.7*Ø16/M15*1.5)



TO1532 / TO1533
Link Stabilizer
L=73

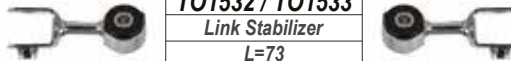

TO1534
Link Stabilizer
L=146

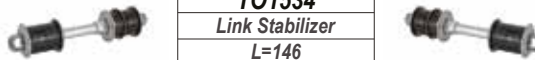

CM1510
Link Stabilizer
L=159.5

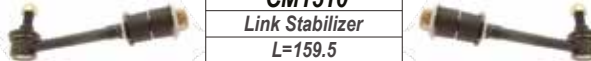

CA1611
Upper Ball Joint
(Ø17)



FT1710
Upper Control Arm



FT1711
Upper Control Arm

CA1611
Upper Ball Joint
(Ø17)



FT1910
Lower Ball Joint
(Ø16.8)



TO2130
Lower Control Arm Bush



FT1910
Lower Ball Joint
(Ø16.8)



CA1910
Lower Ball Joint
(Ø18)



CA2010
Lower Control Arm



CA2011
Lower Control Arm



CA1910
Lower Ball Joint
(Ø18)

LEFT

RIGHT

TOYOTA

HILUX

FRONT

RN20 / RN25 / RN30 / RN40 / RN22 / RN31 / RN41

Year

1974-1984

TO2211
Center Rod

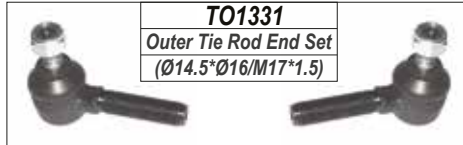
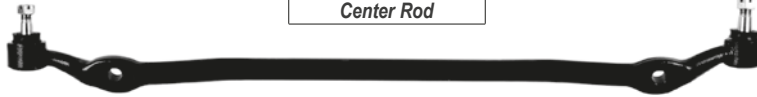

TO1027
Outer Tie Rod End
(Ø14.5*Ø16/M17*1.5)



TO1112
Inner Tie Rod End
(Ø14.5*Ø16/M17*1.5)



TO1027
Outer Tie Rod End
(Ø14.5*Ø16/M17*1.5)



TO1210
Tie Rod Assembly



TO1616
Upper Ball Joint
(Ø15.31)



TO1616
Upper Ball Joint
(Ø15.31)



TO1916
Lower Ball Joint
(Ø17.75)



TO1916
Lower Ball Joint
(Ø17.75)



LEFT

RIGHT

TOYOTA

HILUX

FRONT

Year

YN50 / YN55 / YN51 / YN56 / YN58 / RN58 / LN51 / LN57

1984-1998

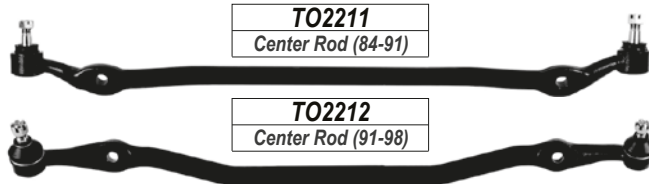

TO2211
Center Rod (84-91)

TO2212
Center Rod (91-98)

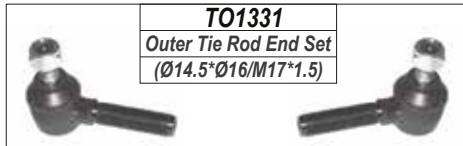

TO1331
Outer Tie Rod End Set
(Ø14.5*Ø16/M17*1.5)

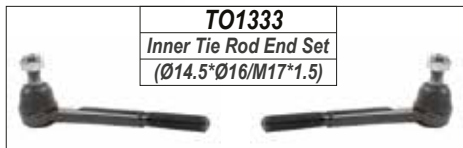

TO1333
Inner Tie Rod End Set
(Ø14.5*Ø16/M17*1.5)

TO1027
Outer Tie Rod End
(Ø14.5*Ø16/M17*1.5)



TO1112
Inner Tie Rod End
(Ø14.5*Ø16/M17*1.5)



TO1027
Outer Tie Rod End
(Ø14.5*Ø16/M17*1.5)



TO1210
Tie Rod Assembly



CA1610
Upper Ball Joint
(Ø17)



CA1710
Upper Control Arm

CA1710
Upper Control Arm

CA1610
Upper Ball Joint
(Ø17)



CA1911
Lower Ball Joint
(Ø18)(84-88)



CA2012
Lower Control Arm
(84-88)



CA2110
Lower Control Arm Bush



CA2013
Lower Control Arm
(84-88)



CA1911
Lower Ball Joint
(Ø18)(84-88)

TO1929
Lower Ball Joint
(Ø18)(88-98)



TO2046
Lower Control Arm
(88-98)



CA2110
Lower Control Arm Bush



TO2047
Lower Control Arm
(88-98)



TO1929
Lower Ball Joint
(Ø18)(88-98)

TO2410
Idler Arm

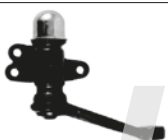

LEFT

RIGHT

TOYOTA

**HILUX
(STANDARD BODY)**

FRONT

YN140 / RZN147 / LN140 / LN145

Year

1998-2005



TO2212
Center Rod

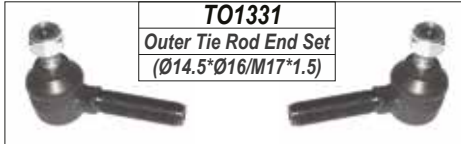

TO1331
Outer Tie Rod End Set
(Ø14.5*Ø16/M17*1.5)



TO1333
Inner Tie Rod End Set
(Ø14.5*Ø16/M17*1.5)



TO1334
Inner Tie Rod End Set
(Ø14.5*Ø16/M21*1.5)

TO1027
Outer Tie Rod End
(Ø14.5*Ø16/M17*1.5)



TO1112
Inner Tie Rod End
(Ø14.5*Ø16/M17*1.5)



TO1027
Outer Tie Rod End
(Ø14.5*Ø16/M17*1.5)



TO1113
Inner Tie Rod End
(Ø14.5*Ø16/M21*1.5)

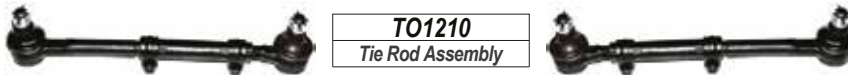

TO1210
Tie Rod Assembly

TO1617
Upper Ball Joint
(Ø15)



TO1718
Upper Control Arm



TO1718
Upper Control Arm

TO1617
Upper Ball Joint
(Ø15)



TO1929
Lower Ball Joint
(Ø18)



TO1929
Lower Ball Joint
(Ø18)



CA2110
Lower Control Arm Bush



TO2411
Idler Arm



TO2046
Lower Control Arm

TO2047
Lower Control Arm

TO2510
Pitman Arm(14mm pin)



TO2511
Pitman Arm



LEFT

RIGHT

TOYOTA

**HILUX FRONT
(RAISED BODY) (4X4)**

RZN194 / LN192 / KZTE

Year

1998-2005

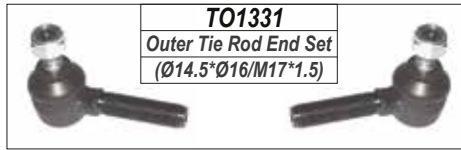

TO1331
Outer Tie Rod End Set
(Ø14.5*Ø16/M17*1.5)

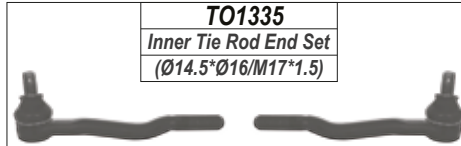

TO1335
Inner Tie Rod End Set
(Ø14.5*Ø16/M17*1.5)

TO1027
Outer Tie Rod End
(Ø14.5*Ø16/M17*1.5)



TO1114
Inner Tie Rod End
(Ø14.5*Ø16/M17*1.5)



TO1027
Outer Tie Rod End
(Ø14.5*Ø16/M17*1.5)



TO1535
Link Stabilizer
L=151

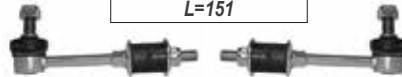

TO1618
Upper Ball Joint
(Ø16.75)



TO1719
Upper Control Arm



TO1720
Upper Control Arm



TO1618
Upper Ball Joint
(Ø16.75)

TO1930
Lower Ball Joint
(Ø18)



TO2048
Lower Control Arm



TO2049
Lower Control Arm



TO1930
Lower Ball Joint
(Ø18)

TO2412
Idler Arm



TO2511
Pitman Arm



LEFT

RIGHT

TOYOTA

**HILUX FRONT
(STANDARD BODY)**

ALL MODELS

Year

2005-2016

TO1041
Outer Tie Rod End
(Ø13.5*Ø16/M15*1.5)

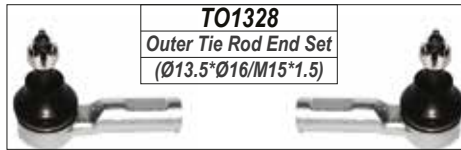

TO1328
Outer Tie Rod End Set
(Ø13.5*Ø16/M15*1.5)

TO1041
Outer Tie Rod End
(Ø13.5*Ø16/M15*1.5)



TO1424
Rack End
(14*1.5/15*1.5/294)

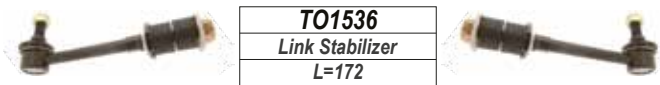

TO1536
Link Stabilizer
L=172

TO1613
Upper Ball Joint
(Ø15)



TO1811
Upper Control Arm Bush

TO1721
Upper Control Arm

TO1722
Upper Control Arm

TO1613
Upper Ball Joint
(Ø15)



TO1915
Lower Ball Joint
(Ø16.7)



TO2123
Lower Control Arm Bush

TO2050
Lower Control Arm

TO2051
Lower Control Arm

TO1915
Lower Ball Joint
(Ø16.7)



TO2822
Shock Mounting



TO2124
Lower Control Arm Bush

TO2822
Shock Mounting



TO2823
Shock Mounting



TO2823
Shock Mounting



LEFT

RIGHT

TOYOTA

**HILUX
(RAISED BODY)**

FRONT

ALL MODELS

Year

2005-2016

TO1042
Outer Tie Rod End
(Ø15.3*Ø17.1/M15*1.5)



TO1336
Outer Tie Rod End Set
(Ø15.3*Ø17.1/M15*1.5)

TO1424
Rack End
(14*1.5/15*1.5/294)

TO1042
Outer Tie Rod End
(Ø15.3*Ø17.1/M15*1.5)



TO1530 / TO1531
Link Stabilizer
L=140

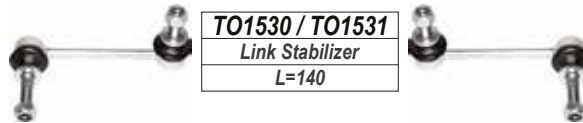

TO1613
Upper Ball Joint
(Ø15)



TO1811
Upper Control Arm Bush



TO1716
Upper Control Arm

TO1717
Upper Control Arm

TO2121
Lower Control Arm Bush



TO1915
Lower Ball Joint
(Ø16.7)



TO1915
Lower Ball Joint
(Ø16.7)



TO2044
Lower Control Arm

TO2045
Lower Control Arm

TO2822
Shock Mounting



TO2122
Lower Control Arm Bush



TO2822
Shock Mounting



TO2823
Shock Mounting



TO2823
Shock Mounting



LEFT

RIGHT

TOYOTA

**HILUX FRONT
(STANDARD BODY 4X2)**

ALL MODELS

Year

2016-

TO1028
Outer Tie Rod End
(Ø15.3*Ø17.1/M16*1.5)

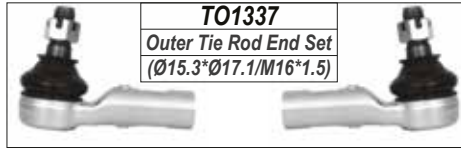

TO1337
Outer Tie Rod End Set
(Ø15.3*Ø17.1/M16*1.5)

TO1425
Rack End
(14*1.5/16*1.5/296)

TO1028
Outer Tie Rod End
(Ø15.3*Ø17.1/M16*1.5)



TO1530 / TO1531
Link Stabilizer
L=140



TO1613
Upper Ball Joint
(Ø15)



TO1811
Upper Control Arm Bush

TO1721
Upper Control Arm

TO1722
Upper Control Arm

TO1613
Upper Ball Joint
(Ø15)



TO1915
Lower Ball Joint
(Ø16.7)



TO2123
Lower Control Arm Bush

TO2050
Lower Control Arm

TO2051
Lower Control Arm

TO1915
Lower Ball Joint
(Ø16.7)



TO2124
Lower Control Arm Bush

LEFT

RIGHT

TOYOTA

**HILUX FRONT
(RAISED BODY 4X2) (4X4)**

ALL MODELS

Year

2016-

TO1028
Outer Tie Rod End
(Ø15.3*Ø17.1/M16*1.5)

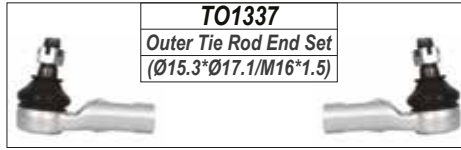

TO1337
Outer Tie Rod End Set
(Ø15.3*Ø17.1/M16*1.5)

TO1425
Rack End
(14*1.5/16*1.5/296)

TO1028
Outer Tie Rod End
(Ø15.3*Ø17.1/M16*1.5)



TO1530 / TO1531
Link Stabilizer
L=140



TO1613
Upper Ball Joint
(Ø15)



TO1716
Upper Control Arm

TO1717
Upper Control Arm

TO1811
Upper Control Arm Bush



TO1613
Upper Ball Joint
(Ø15)



TO1915
Lower Ball Joint
(Ø16.7)



TO2052
Lower Control Arm

TO2053
Lower Control Arm

TO1915
Lower Ball Joint
(Ø16.7)



LEFT

RIGHT

TOYOTA

**LAND CRUISER
(4WD)**

FRONT

ALL MODELS

Year

1985-

TO1044

Outer Tie Rod End
(Ø14.7*Ø16/M23*1.5)



TO1045

Outer Tie Rod End
(Ø14.7*Ø16/M23*1.5)



TO1043

Outer Tie Rod End
(Ø14.65*Ø16.4/M23*1.5)



TO1115

Inner Tie Rod End
(Ø14.65*Ø16.4/M23*1.5)



LEFT

RIGHT

TOYOTA

LAND CRUISER FRONT (4WD)

80 SERIES

Year

1990-1997

TO1044
Outer Tie Rod End
(Ø14.7*Ø16/M23*1.5)



TO1426
Rack End
(18*1.5/20*1.5/132)



TO1045
Outer Tie Rod End
(Ø14.7*Ø16/M23*1.5)



TO1115
Inner Tie Rod End
(Ø14.65*Ø16.4/M23*1.5)



TO1116
Inner Tie Rod End
(Ø14.7*Ø16/M23*1.5)



TO1117
Inner Tie Rod End
(Ø14.7*Ø16/M23*1.5)



TO1118
Inner Tie Rod End
(Ø14.7*Ø16/M23*1.5)



TO1619
Lower Ball Joint
(Ø16.2)



TO1537 / TO1538
Link Stabilizer
L=62.5



TO1619
Lower Ball Joint
(Ø16.2)



TO1931
Lower Ball Joint
(Ø17.5)



TO1539
Link Stabilizer
L=156



TO1932
Lower Ball Joint
(Ø17.5)



LAND CRUISER REAR (4WD)

TO1540
Link Stabilizer
L=98



LEFT

RIGHT

TOYOTA

**LAND CRUISER
PRADO (4WD)**

FRONT

90 SERIES. 95 SERIES

Year

1996-2002

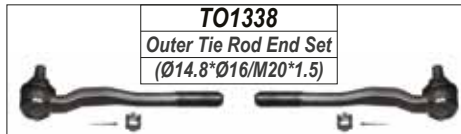

T01046
Outer Tie Rod End
(Ø14.8*Ø16/M20*1.5)

T01426
Rack End
(18*1.5/20*1.5/132)

T01047
Outer Tie Rod End
(Ø14.8*Ø16/M20*1.5)



T01541
Link Stabilizer
L=178



T01619
Lower Ball Joint
(Ø16.2)



T01812
Upper Control Arm Bush



T01619
Lower Ball Joint
(Ø16.2)



T01723
Upper Control Arm

T01724
Upper Control Arm

T01931
Lower Ball Joint
(Ø17.5)



T02138
Upper Control Arm Bush



T01932
Lower Ball Joint
(Ø17.5)



T02054
Lower Control Arm

T02055
Lower Control Arm

**LAND CRUISER
(4WD)**

REAR

T01542
Link Stabilizer
L=153



LEFT

RIGHT

TOYOTA

**LAND CRUISER
(4WD)**

FRONT

100 SERIES

Year

1998-2006

TO1339
Outer Tie Rod End Set
(Ø18.3*Ø20/M20*1.5)

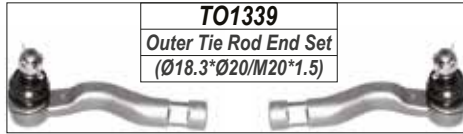

TO1427
Rack End
(27*1.5/20*1.5/207)



TO1049
Outer Tie Rod End
(Ø18.3*Ø20/M20*1.5)



TO1048
Outer Tie Rod End
(Ø18.3*Ø20/M20*1.5)



TO1340
Outer Tie Rod End Set
(Ø18.3*Ø20/M20*1.5)



TO1428
Rack End
(18*1.5/20*1.5/197)



TO1051
Outer Tie Rod End
(Ø18.3*Ø20/M20*1.5)



TO1050
Outer Tie Rod End
(Ø18.3*Ø20/M20*1.5)



TO1543 / TO1544
Link Stabilizer
L=115.5



TO1610
Upper Ball Joint
(Ø15.8)



TO1610
Upper Ball Joint
(Ø15.8)



TO1725
Upper Control Arm

TO1726
Upper Control Arm

TO1937
Lower Ball Joint
(Ø20.5)



TO1937
Lower Ball Joint
(Ø20.5)



TO2056
Lower Control Arm

TO2057
Lower Control Arm

LEFT

RIGHT

TOYOTA

**LAND CRUISER
PRADO (4WD)**

FRONT

120 SERIES

Year

2002-2009

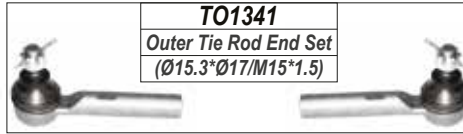

TO1341
Outer Tie Rod End Set
(Ø15.3*Ø17/M15*1.5)

TO1052
Outer Tie Rod End
(Ø15.3*Ø17/M15*1.5)

TO1429
Rack End
(22*1.5/15*1.5/260)

TO1052
Outer Tie Rod End
(Ø15.3*Ø17/M15*1.5)



TO1530 / TO1531
Link Stabilizer
L=140



TO1610
Upper Ball Joint
(Ø15.8)



TO1810
Upper Control Arm Bush

TO1610
Upper Ball Joint
(Ø15.8)



TO1714
Upper Control Arm

TO1715
Upper Control Arm

TO1928
Lower Ball Joint
(Ø17.4)



TO1928
Lower Ball Joint
(Ø17.4)



TO2042
Lower Control Arm

TO2043
Lower Control Arm

**LAND CRUISER
PRADO (4WD)**

REAR

TO1545
Link Stabilizer
L=173.5



LEFT

RIGHT

TOYOTA

**LAND CRUISER
PRADO**

FRONT

150 SERIES

Year

2009-2015

TO1040
Outer Tie Rod End
(Ø15.3*Ø17/M16*1.5)

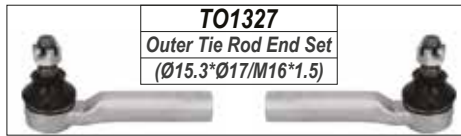

TO1327
Outer Tie Rod End Set
(Ø15.3*Ø17/M16*1.5)

TO1430
Rack End
(24*1.5/16*1.5/277)



TO1040
Outer Tie Rod End
(Ø15.3*Ø17/M16*1.5)



TO1431
Rack End
(28*1.5/22*1.5/234)



TO1530 / TO1531
Link Stabilizer
L=140

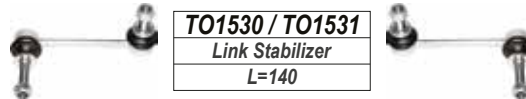

TO1546 / TO1547
Link Stabilizer
L=96

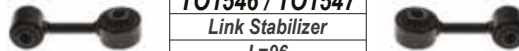

TO1610
Upper Ball Joint
(Ø15.8)



TO1810
Upper Control Arm Bush

TO1610
Upper Ball Joint
(Ø15.8)



TO1714
Upper Control Arm

TO1715
Upper Control Arm

TO1933
Lower Ball Joint
(Ø17.4)



TO2139
Lower Control Arm Bush

TO2133
Lower Control Arm Bush

TO1933
Lower Ball Joint
(Ø17.4)



TO2058
Lower Control Arm

TO2059
Lower Control Arm

**LAND CRUISER
PRADO**

REAR

TO1545
Link Stabilizer
L=173.5



TO2610
Lateral Link



LEFT

RIGHT

TOYOTA

LAND CRUISER

FRONT

200 SERIES

Year

2007-2017

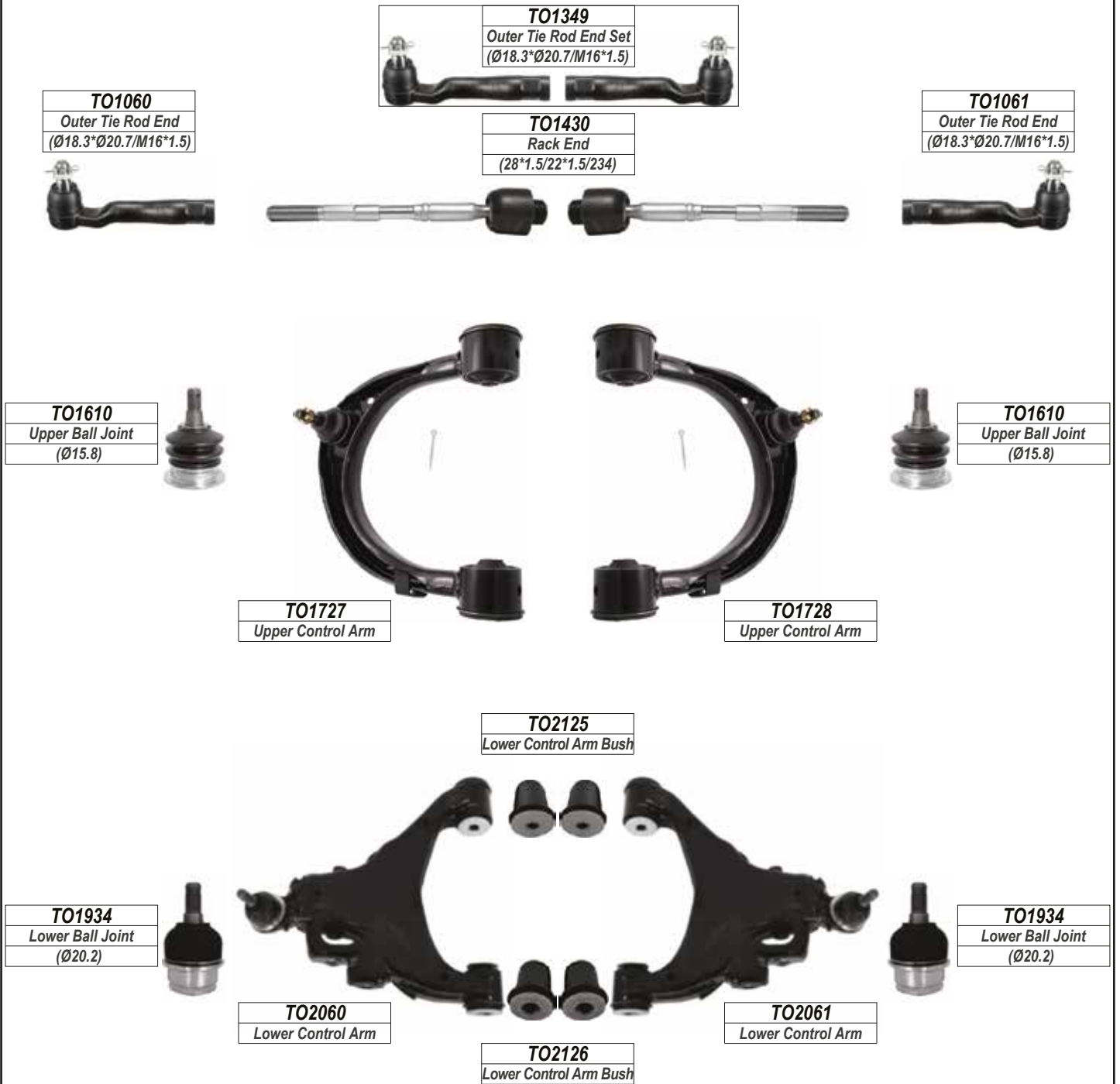

LEFT

RIGHT

TOYOTA

MR2

FRONT

ALL MODELS

Year

2001-

TO1059
Outer Tie Rod End
(Ø12.5*Ø14/M12*1.25)

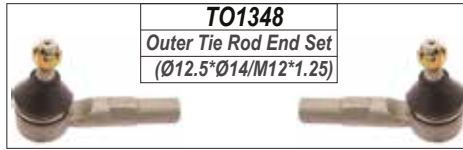

TO1348
Outer Tie Rod End Set
(Ø12.5*Ø14/M12*1.25)

TO1059
Outer Tie Rod End
(Ø12.5*Ø14/M12*1.25)



TO1435
Rack End
(14*1.5/12*1.25/360)



TO1551
Link Stabilizer
L=105



TO1936
Lower Ball Joint
(Ø13.5)



TO2062
Lower Control Arm



TO2063
Lower Control Arm

TO1936
Lower Ball Joint
(Ø13.5)



LEFT

RIGHT

TOYOTA

QUANTUM

FRONT

ALL MODELS

Year

2005-

CM1010
Outer Tie Rod End
(Ø14*Ø17/M15*1.5)

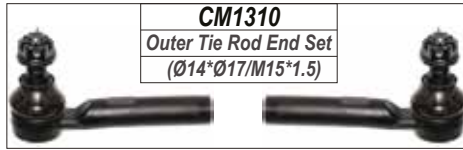

CM1310
Outer Tie Rod End Set
(Ø14*Ø17/M15*1.5)

CM1010
Outer Tie Rod End
(Ø14*Ø17/M15*1.5)



CA1411
Rack End
(14*1.5/15*1.5/274)



CM1510
Link Stabilizer
L=159.5



CM1710
Upper Control Arm

CM1711
Upper Control Arm

TO2130
Lower Control Arm Bush



CM1910
Lower Ball Joint
(Ø17.25)



CM2010
Lower Control Arm



CM2011
Lower Control Arm

CM1910
Lower Ball Joint
(Ø17.25)



LEFT

RIGHT

TOYOTA

QUANTUM

FRONT

ALL MODELS

Year

2019-

TO1062
<i>Outer Tie Rod End</i>

TO1350
<i>Outer Tie Rod End Set</i>

TO1063
<i>Outer Tie Rod End</i>

TO1437
<i>Rack End</i>

TO1552 / TO1553
<i>Link Stabilizer</i>

TO2141
<i>Lower Control Arm Bush</i>

TO1942
<i>Lower Ball Joint</i>

TO1942
<i>Lower Ball Joint</i>

TO2075
<i>Lower Control Arm</i>

TO2076
<i>Lower Control Arm</i>

TO2142
<i>Lower Control Arm Bush</i>

LEFT

RIGHT

TOYOTA

RAV4

FRONT

Year

1995-2000

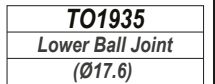
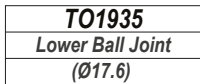
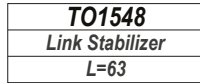
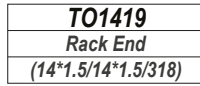
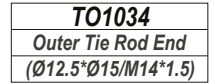
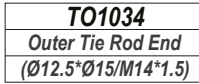
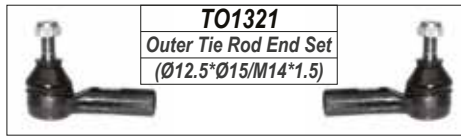

LEFT

RIGHT

TOYOTA

RAV4

FRONT

Year

2000-2006

II

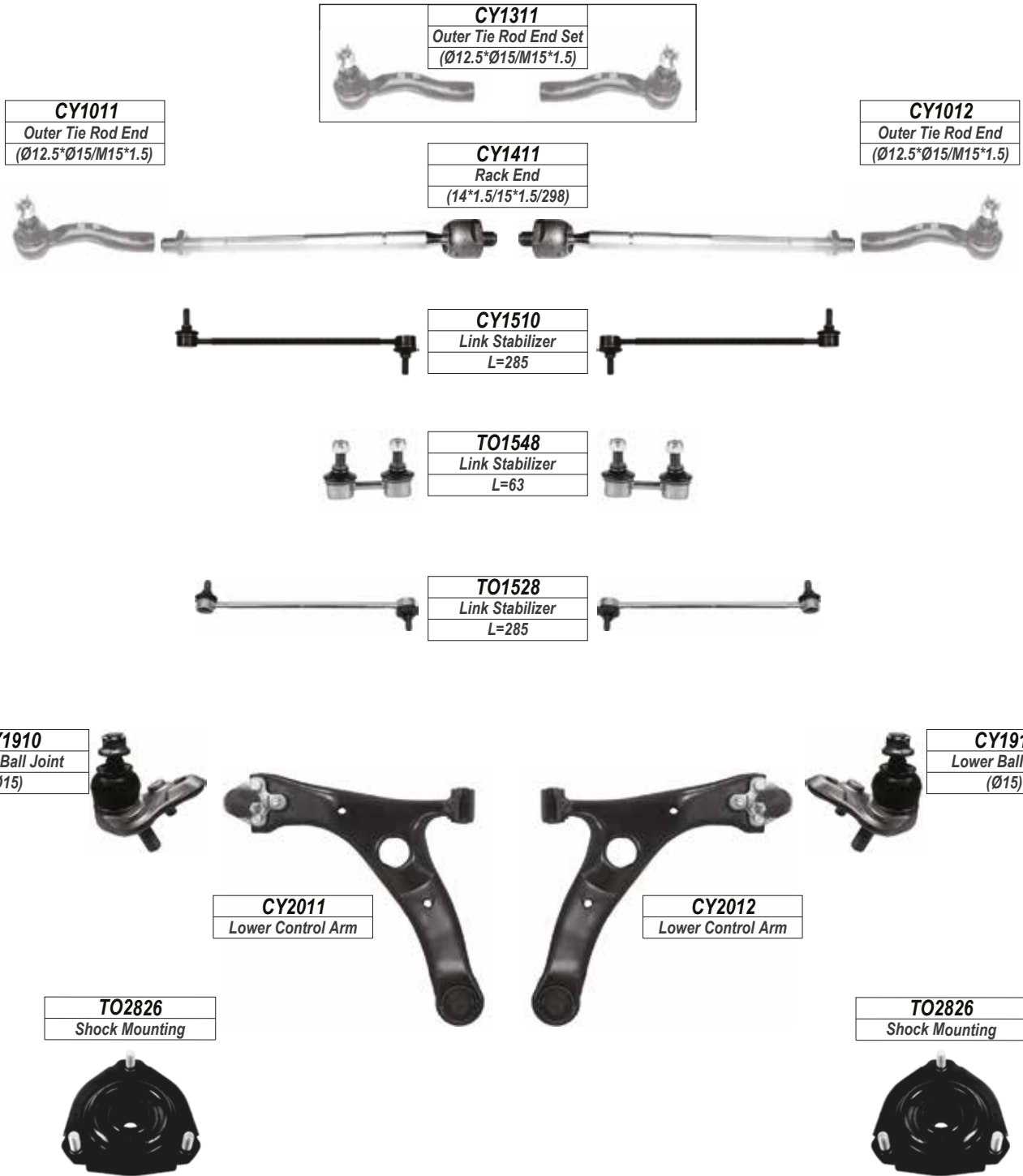

RAV4

REAR



LEFT

RIGHT

TOYOTA

RAV4

FRONT

III

Year

2006-2012

TO1343
Outer Tie Rod End Set
(Ø13.6*Ø16.1/M16*1.5)

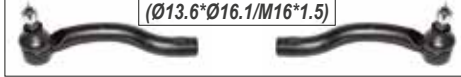

TO1053
Outer Tie Rod End
(Ø13.6*Ø16.1/M16*1.5)



TO1436
Rack End
(16*1.5/16*1.5/243)



TO1054
Outer Tie Rod End
(Ø13.6*Ø16.1/M16*1.5)



TO1511
Link Stabilizer
L=360



TO1918
Lower Ball Joint
(Ø17.5)



TO2066
Lower Control Arm



TO2067
Lower Control Arm

TO1918
Lower Ball Joint
(Ø17.5)



TO2827
Shock Mounting



TO2828
Shock Mounting



TO2827
Shock Mounting



TO2828
Shock Mounting



RAV4

REAR

TO1549
Link Stabilizer
L=137.5



LEFT

RIGHT

TOYOTA

RAV4

FRONT

Year

IV

2006-2012

TO1343
Outer Tie Rod End Set
(Ø13.6*Ø16.1/M16*1.5)



TO1053
Outer Tie Rod End
(Ø13.6*Ø16.1/M16*1.5)



TO1054
Outer Tie Rod End
(Ø13.6*Ø16.1/M16*1.5)



TO1511
Link Stabilizer
L=360



TO1918
Lower Ball Joint
(Ø17.5)



TO1918
Lower Ball Joint
(Ø17.5)



TO2072
Lower Control Arm



TO2073
Lower Control Arm



TO2829
Shock Mounting



TO2829
Shock Mounting



LEFT

RIGHT

TOYOTA

STARLET

FRONT

ALL MODELS

Year

2020-

SZ1319

Outer Tie Rod End Set
(Ø12.9*Ø14.9/M14*1.5)

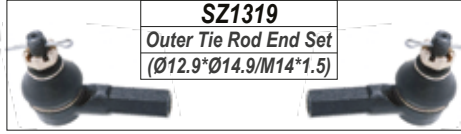

SZ1021

Outer Tie Rod End
(Ø12.9*Ø14.9/M14*1.5)



SZ1417

Rack End
(14*1.5/14*1.5/323)



SZ1022

Outer Tie Rod End
(Ø12.9*Ø14.9/M14*1.5)



SZ1517

Link Stabilizer
L=350



SZ2114

Lower Control Arm Bush

SZ1913

Lower Ball Joint
(Ø13.5)



SZ1913

Lower Ball Joint
(Ø13.5)



SZ2024

Lower Control Arm

SZ2025

Lower Control Arm

SZ2115

Lower Control Arm Bush

LEFT

RIGHT

TOYOTA

YARIS

FRONT

ALL MODELS

Year

2005-

TO1323
Outer Tie Rod End Set
(Ø12.55*Ø15/M14*1.5)

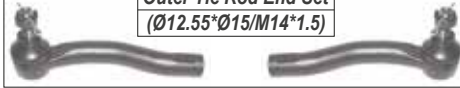

TO1422
Rack End
(14*1.5/14*1.5/274)

TO1432
Rack End
(14*1.5/14*1.5/240)

TO1344
Outer Tie Rod End Set
(Ø12.55*Ø15/M12*1.25)

TO1433
Rack End
(14*1.5/12*1.25/256)

TO1550
Link Stabilizer
L=360

TO2128
Lower Control Arm Bush

TO2129
Lower Control Arm Bush

TO1037
Outer Tie Rod End
(Ø12.55*Ø15/M14*1.5)



TO1038
Outer Tie Rod End
(Ø12.55*Ø15/M14*1.5)



TO1056
Outer Tie Rod End
(Ø12.55*Ø15/M12*1.25)



TO1055
Outer Tie Rod End
(Ø12.55*Ø15/M12*1.25)



CI1913
Lower Ball Joint
(Ø13.5)



CI1913
Lower Ball Joint
(Ø13.5)



TO2070
Lower Control Arm



TO2071
Lower Control Arm

TO2830
Shock Mounting



TO2830
Shock Mounting



TO2068
Lower Control Arm
2013-



TO2069
Lower Control Arm
2013-



LEFT

RIGHT

VOLKSWAGEN

AMAROK

FRONT

ALL MODELS

Year

2010-

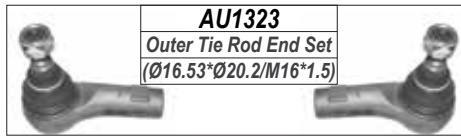

AU1323
Outer Tie Rod End Set
(Ø16.53*Ø20.2/M16*1.5)

AU1035
Outer Tie Rod End
(Ø16.53*Ø20.2/M16*1.5)

AU1419
Rack End
(16*1.5 /16*1.5/291)

AU1036
Outer Tie Rod End
(Ø16.53*Ø20.2/M16*1.5)



VW1510
Link Stabilizer
L=145



VW1511
Link Stabilizer
L=146



VW1610
Upper Ball Joint
(Ø15.75)



VW1810
Upper Control Arm Bush

VW1610
Upper Ball Joint
(Ø15.75)



VW1710
Upper Control Arm

VW1711
Upper Control Arm

VW2111
Lower Control Arm Bush

VW2110
Lower Control Arm Bush

VW2111
Lower Control Arm Bush

VW1910
Lower Ball Joint
(Ø20.7)



VW2010
Lower Control Arm

VW2011
Lower Control Arm

VW1910
Lower Ball Joint
(Ø20.7)



VW2820
Shock Mounting



VW2112
Lower Control Arm Bush

VW2810
Stabilizer Bar Bush



VW2820
Shock Mounting



LEFT

RIGHT

VOLKSWAGEN

BEETLE

FRONT

ALL MODELS

Year

1999-2010

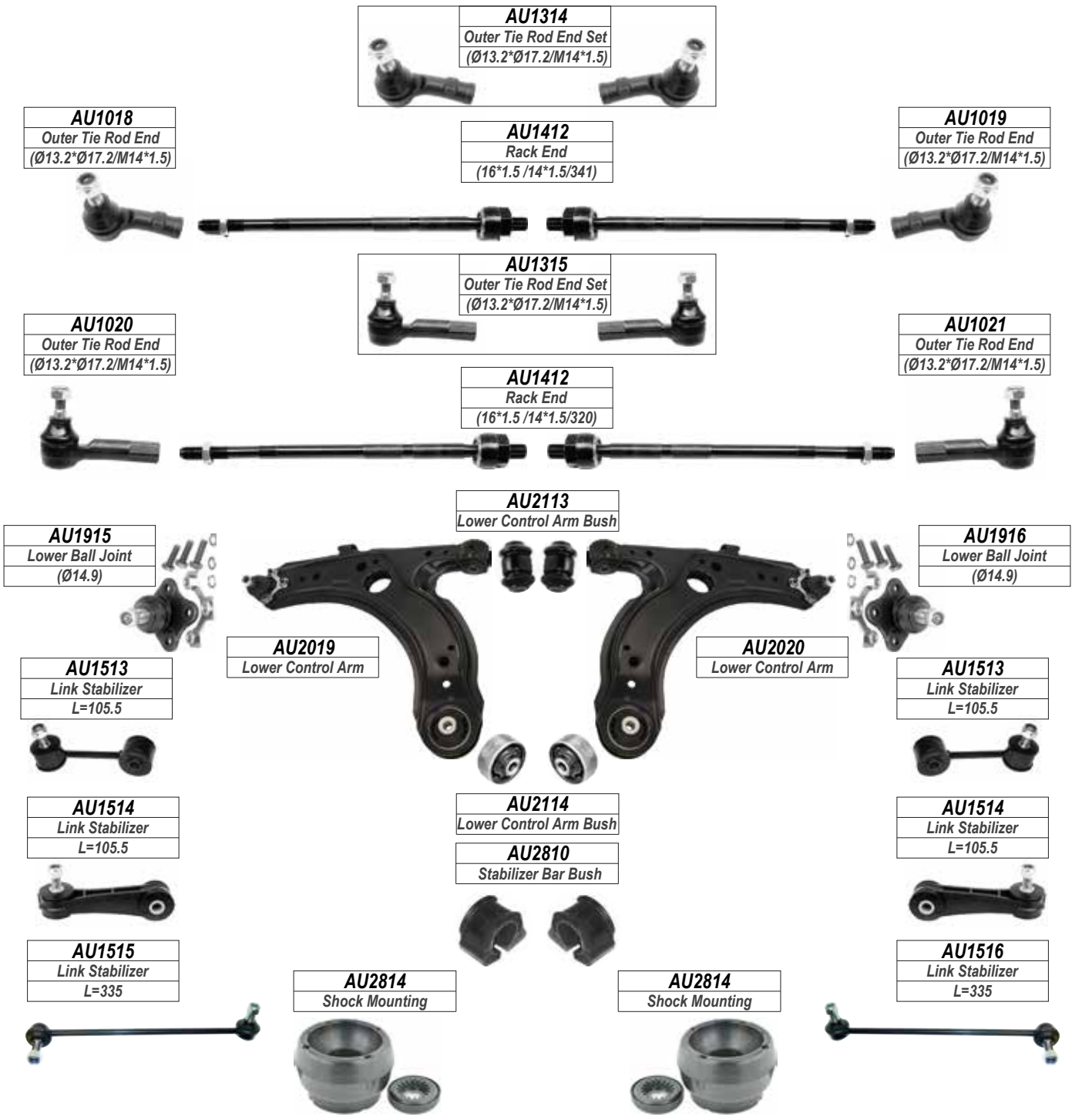

BEETLE REAR



LEFT

RIGHT

VOLKSWAGEN

BEETLE

FRONT

ALL MODELS

Year

2011-

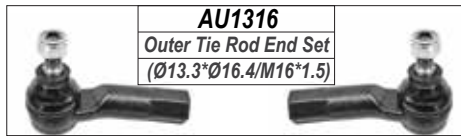

AU1316
Outer Tie Rod End Set
(Ø13.3*Ø16.4/M16*1.5)

AU1030
Outer Tie Rod End
(Ø13.3*Ø16.4/M16*1.5)



AU1031
Outer Tie Rod End
(Ø13.3*Ø16.4/M16*1.5)



VW1413
Rack End
(16*1.5/16*1.5/329)



AU1518
Link Stabilizer
L=335



AU2115
Lower Control Arm Bush



AU1917
Lower Ball Joint
(Ø15.4)



VW2012
Lower Control Arm

VW2013
Lower Control Arm

AU1918
Lower Ball Joint
(Ø15.4)



AU2817
Shock Mounting



AU2817
Shock Mounting



VW2113
Lower Control Arm Bush



BEETLE

REAR

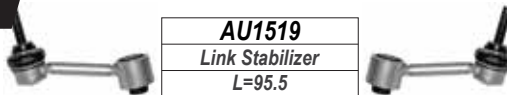

AU1519
Link Stabilizer
L=95.5

AU2915
Bush
(ID: Ø14.3/OD: Ø24.3)



VW2911
Bush



VW2911
Bush

AU2610
Lateral Link



AU2610
Lateral Link



AU1710
Upper Control Arm



VW2114
Lower Control Arm Bush



VW2014
Lower Control Arm



VW2014
Lower Control Arm



AU2080 / AU2081
Lower Control Arm

LEFT

RIGHT

VOLKSWAGEN

CADDY I

FRONT

LDV

Year

1981-2003

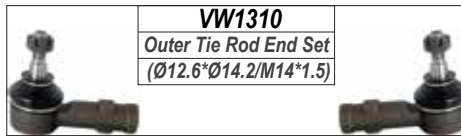

VW1310
Outer Tie Rod End Set
(Ø12.6*Ø14.2/M14*1.5)

VW1012
Outer Tie Rod End
(Ø12.6*Ø14.2/M14*1.5)

VW1414
Rack End
(22*1.5 /14*1.5/341)

VW1012
Outer Tie Rod End
(Ø12.6*Ø14.2/M14*1.5)



VW1512
Link Stabilizer
L=75



VW2115
Lower Control Arm Bush

VW1911
Lower Ball Joint
(Ø17)



VW1911
Lower Ball Joint
(Ø17)

VW2015
Lower Control Arm

VW2016
Lower Control Arm

VW2821
Shock Mounting



VW2116
Lower Control Arm Bush

VW2821
Shock Mounting

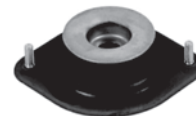

LEFT

RIGHT

VOLKSWAGEN

CADDY III

FRONT

ALL MODELS

Year

2004-2015

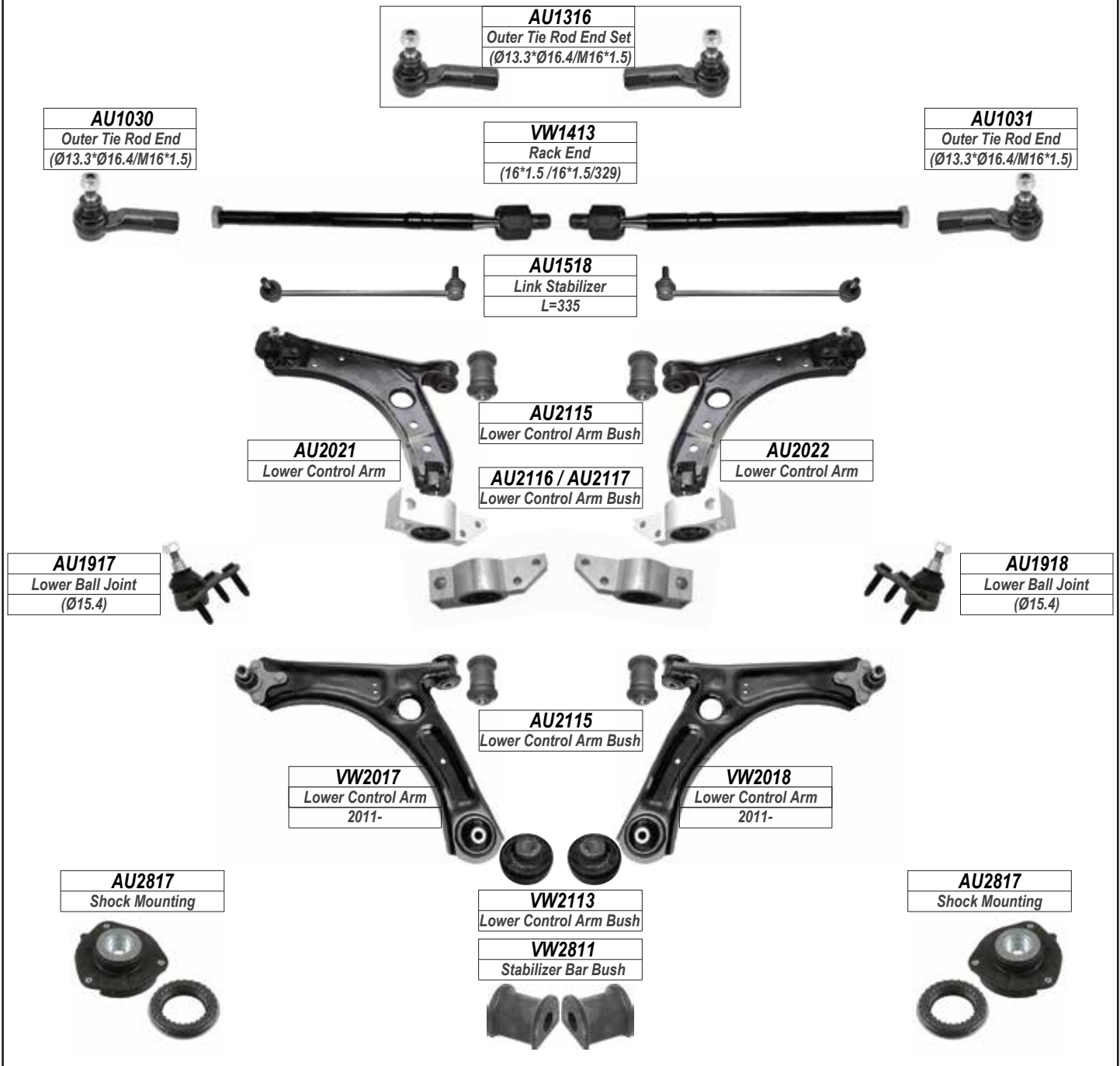

CADDY III REAR

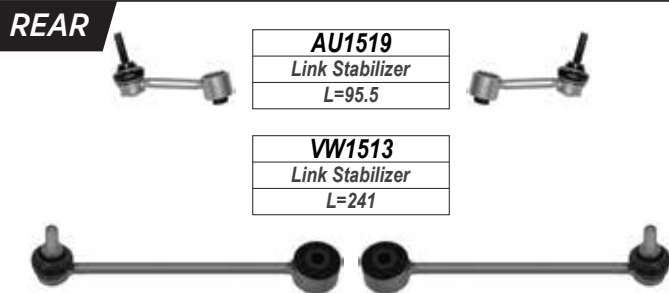

LEFT

RIGHT

VOLKSWAGEN

CC

FRONT

ALL MODELS

Year

2011-

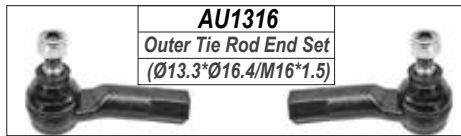

AU1316
Outer Tie Rod End Set
(Ø13.3*Ø16.4/M16*1.5)

AU1030
Outer Tie Rod End
(Ø13.3*Ø16.4/M16*1.5)

VW1413
Rack End
(16*1.5 /16*1.5/329)

AU1031
Outer Tie Rod End
(Ø13.3*Ø16.4/M16*1.5)

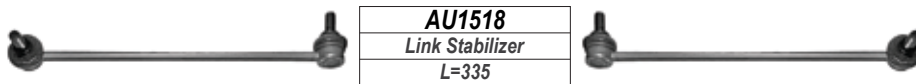

AU1518
Link Stabilizer
L=335

VW1912
Lower Ball Joint
(Ø15.3)



AU2115
Lower Control Arm Bush



VW1913
Lower Ball Joint
(Ø15.3)



VW2019
Lower Control Arm

VW2020
Lower Control Arm

AU2817
Shock Mounting

AU2817
Shock Mounting



AU2134
Lower Control Arm Bush

CC REAR

AU2915
Bush
(ID: Ø14.3/OD: Ø24.3)

VW2911
Bush

VW2911
Bush



AU2610
Lateral Link

AU2610
Lateral Link



AU1519
Link Stabilizer
L=95.5

AU1519
Link Stabilizer
L=95.5

AU1710
Upper Control Arm

VW2114
Lower Control Arm Bush



VW2014
Lower Control Arm

VW2014
Lower Control Arm



AU2080 / AU2081
Lower Control Arm



LEFT

RIGHT

VOLKSWAGEN
CRAFTER
FRONT
ALL MODELS

Year

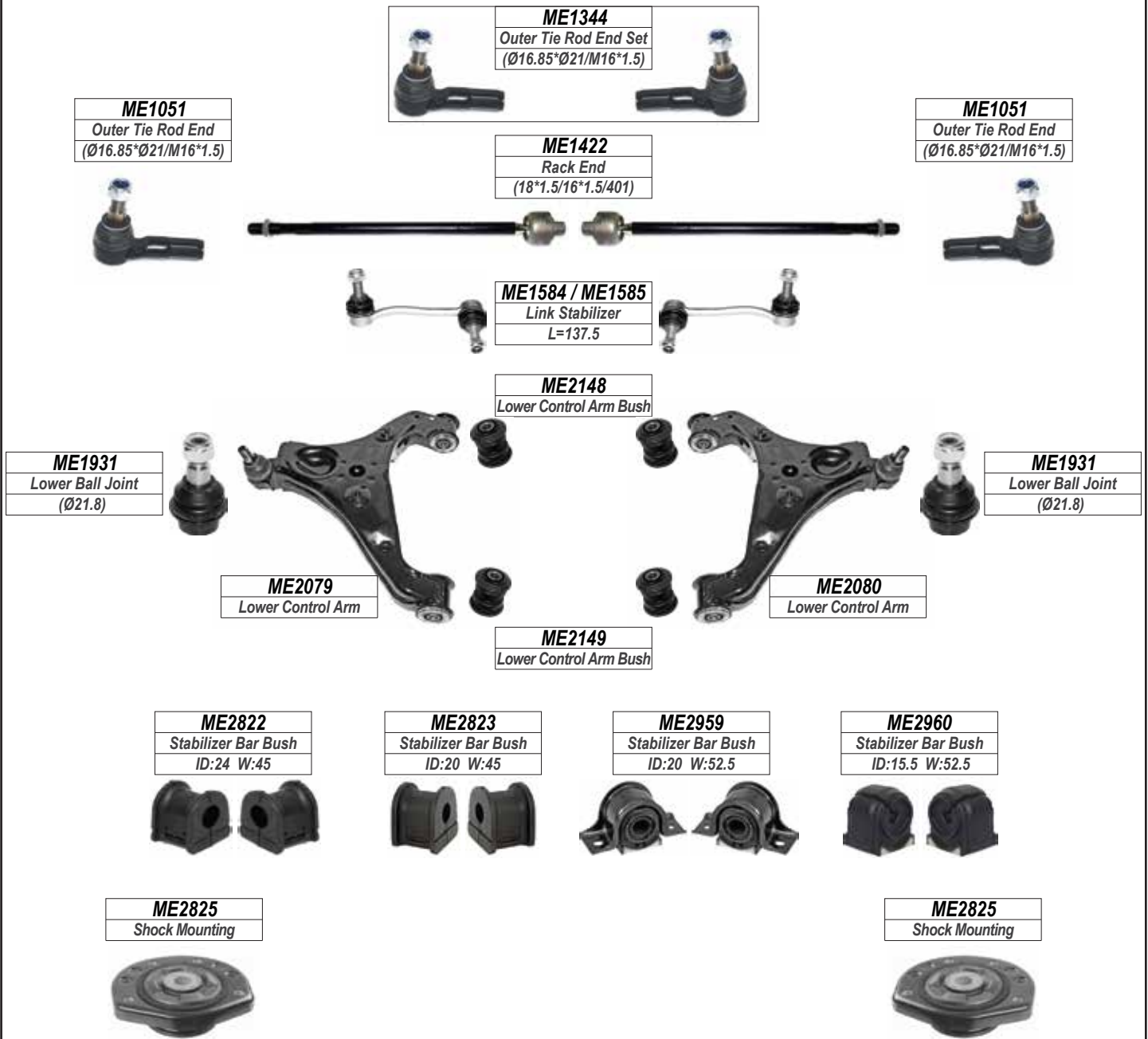
2006-

CRAFTER
REAR

LEFT
RIGHT

VOLKSWAGEN

EOS

FRONT

ALL MODELS

Year

2007-

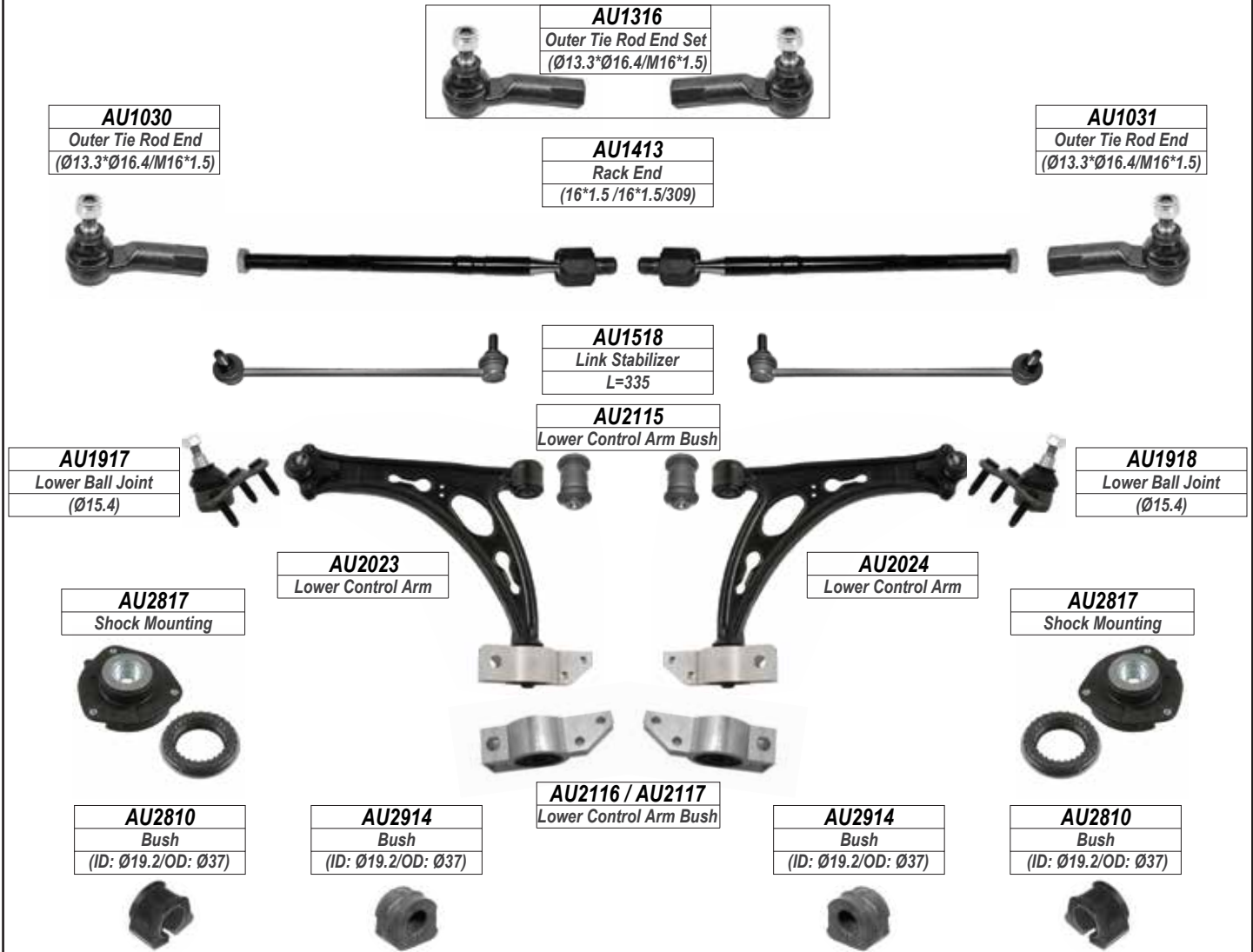

EOS REAR



VOLKSWAGEN

**GOLF I / CITY GOLF FRONT
FOX**

ALL MODELS

Year

1974-2009

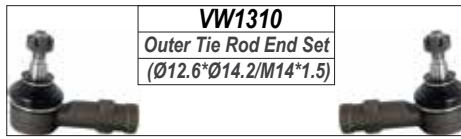

VW1310
Outer Tie Rod End Set
(Ø12.6*Ø14.2/M14*1.5)

VW1012
Outer Tie Rod End
(Ø12.6*Ø14.2/M14*1.5)

VW1414
Rack End
(22*1.5 /14*1.5/341)

VW1012
Outer Tie Rod End
(Ø12.6*Ø14.2/M14*1.5)



VW1512
Link Stabilizer
L=75



VW1911
Lower Ball Joint
(Ø17)



VW1911
Lower Ball Joint
(Ø17)



VW2115
Lower Control Arm Bush



VW1914
Lower Ball Joint
(Ø15)



VW2015
Lower Control Arm

VW2016
Lower Control Arm

VW1914
Lower Ball Joint
(Ø15)



VW2821
Shock Mounting



VW2116
Lower Control Arm Bush



VW2821
Shock Mounting



**GOLF I / CITY GOLF REAR
FOX**

VW2823
Shock Mounting
ID:18 H:84



VW2823
Shock Mounting
ID:18 OD:29



VW2824
Shock Mounting
ID:31 H:38



VW2824
Shock Mounting
ID:31 H:38



LEFT

RIGHT

VOLKSWAGEN

GOLF II

FRONT

ALL MODELS

Year

1984-1992

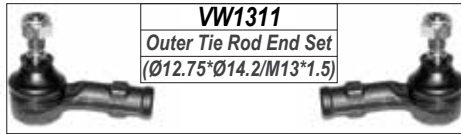

VW1311
Outer Tie Rod End Set
(Ø12.75*Ø14.2/M13*1.5)

VW1013
Outer Tie Rod End
(Ø12.75*Ø14.2/M13*1.5)

VW1415
Rack End
(22*1.5/14*1.5/328)(M/S)

VW1014
Outer Tie Rod End
(Ø12.75*Ø14.2/M13*1.5)



VW1416
Rack End
(14*1.5/14*1.5/340)(P/S)



VW1512
Link Stabilizer
L=75

VW1915
Lower Ball Joint
(Ø17)



VW2021
Lower Control Arm

AU2113
Lower Control Arm Bush

VW2022
Lower Control Arm



VW1915
Lower Ball Joint
(Ø17)

VW2117
Lower Control Arm Bush

VW1926
Lower Ball Joint
(Ø19)



VW2023
Lower Control Arm

AU2113
Lower Control Arm Bush

VW2024
Lower Control Arm



VW1926
Lower Ball Joint
(Ø19)

VW2117
Lower Control Arm Bush

VW1916
Lower Ball Joint
(Ø19)



VW1916
Lower Ball Joint
(Ø19)

VW2822
Shock Mounting

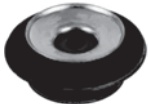

VW2813
Stabilizer Bar Bush
ID:17 OD:35



VW2814
Stabilizer Bar Bush
ID:19 OD:37



VW2822
Shock Mounting

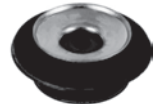

GOLF II

REAR

VW2823
Shock Mounting
ID:18 H:84



VW2824
Shock Mounting
ID:31 H:38



VW2914
Bush



VW2824
Shock Mounting
ID:31 H:38



VW2823
Shock Mounting
ID:18 OD:29



LEFT

RIGHT

VOLKSWAGEN
GOLF III FRONT

ALL MODELS

Year

1992-1999

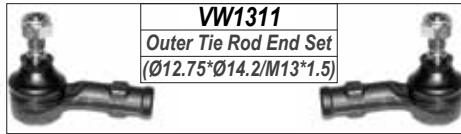

VW1311
Outer Tie Rod End Set
(Ø12.75*Ø14.2/M13*1.5)

VW1013
Outer Tie Rod End
(Ø12.75*Ø14.2/M13*1.5)

VW1417
Rack End
(22*1.5/14*1.5/381)(M/S)

VW1014
Outer Tie Rod End
(Ø12.75*Ø14.2/M13*1.5)



VW1418
Rack End
(14*1.5/14*1.5/369)(P/S)



VW1512
Link Stabilizer
L=75



AU2914
Stabilizer Bar Bush
(ID: Ø19.2/OD: Ø37)

AU2810
Bush
(ID: Ø19.2/OD: Ø37)

VW2814
Stabilizer Bar Bush
ID:19 OD:37



VW1512
Link Stabilizer
L=75

VW1514
Link Stabilizer
L=51



VW1514
Link Stabilizer
L=51

VW1515
Link Stabilizer
L=78



VW1515
Link Stabilizer
L=78

VW1926
Lower Ball Joint
(Ø19)



AU2113
Lower Control Arm Bush



VW1926
Lower Ball Joint
(Ø19)

VW1916
Lower Ball Joint
(Ø19)



VW2050
Lower Control Arm



VW2117
Lower Control Arm Bush



VW2051
Lower Control Arm



VW1916
Lower Ball Joint
(Ø19)

VW1917
Lower Ball Joint
(Ø16.5)(VR6 Only)



AU2113
Lower Control Arm Bush



VW2027
Lower Control Arm
VR6 Only



VW1917
Lower Ball Joint
(Ø16.5)(VR6 Only)

VW2825
Shock Mounting



VW2825
Shock Mounting



VW2117
Lower Control Arm Bush

GOLF III REAR

VW2823
Shock Mounting
ID:18 H:84



VW2824
Shock Mounting
ID:31 H:38



VW2914
Bush



VW2824
Shock Mounting
ID:31 H:38



VW2823
Shock Mounting
ID:18 OD:29



LEFT

RIGHT

VOLKSWAGEN

GOLF IV

FRONT

ALL MODELS

Year

1999-2004

AU1314
Outer Tie Rod End Set
(Ø13.2*Ø17.2/M14*1.5)

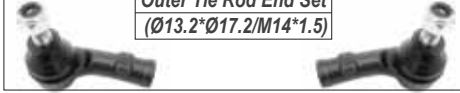

AU1018
Outer Tie Rod End
(Ø13.2*Ø17.2/M14*1.5)



AU1412
Rack End
(16*1.5 /14*1.5/341)



AU1019
Outer Tie Rod End
(Ø13.2*Ø17.2/M14*1.5)



AU1315
Outer Tie Rod End Set
(Ø13.2*Ø17.2/M14*1.5)



AU1020
Outer Tie Rod End
(Ø13.2*Ø17.2/M14*1.5)



AU1411
Rack End
(16*1.5 /14*1.5/320)



AU1021
Outer Tie Rod End
(Ø13.2*Ø17.2/M14*1.5)



AU2113
Lower Control Arm Bush



AU1915
Lower Ball Joint
(Ø14.9)



AU1916
Lower Ball Joint
(Ø14.9)

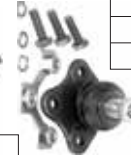

AU2019
Lower Control Arm

AU2020
Lower Control Arm

AU1513
Link Stabilizer
L=105.5



AU1513
Link Stabilizer
L=105.5



AU1514
Link Stabilizer
L=105.5



AU1514
Link Stabilizer
L=105.5



AU1545
Link Stabilizer
L=335



AU2810
Stabilizer Bar Bush



AU1546
Link Stabilizer
L=335



AU2814
Shock Mounting



AU2814
Shock Mounting



LEFT

RIGHT

VOLKSWAGEN

GOLF IV

REAR

ALL MODELS

Year

1999-2004

AU1517
Link Stabilizer
L=175



VW2610
Lateral Link



VW2610
Lateral Link



VW2611
Lateral Link



VW2611
Lateral Link

AU2913
Bush
(ID: Ø12.2/OD: Ø50)



AU2912
Bush
(ID: Ø12.2/OD: Ø71.5)



AU2815
Shock Mounting



AU2815
Shock Mounting



LEFT

RIGHT

VOLKSWAGEN

GOLF V / VI

FRONT

ALL MODELS

Year

2004-2012

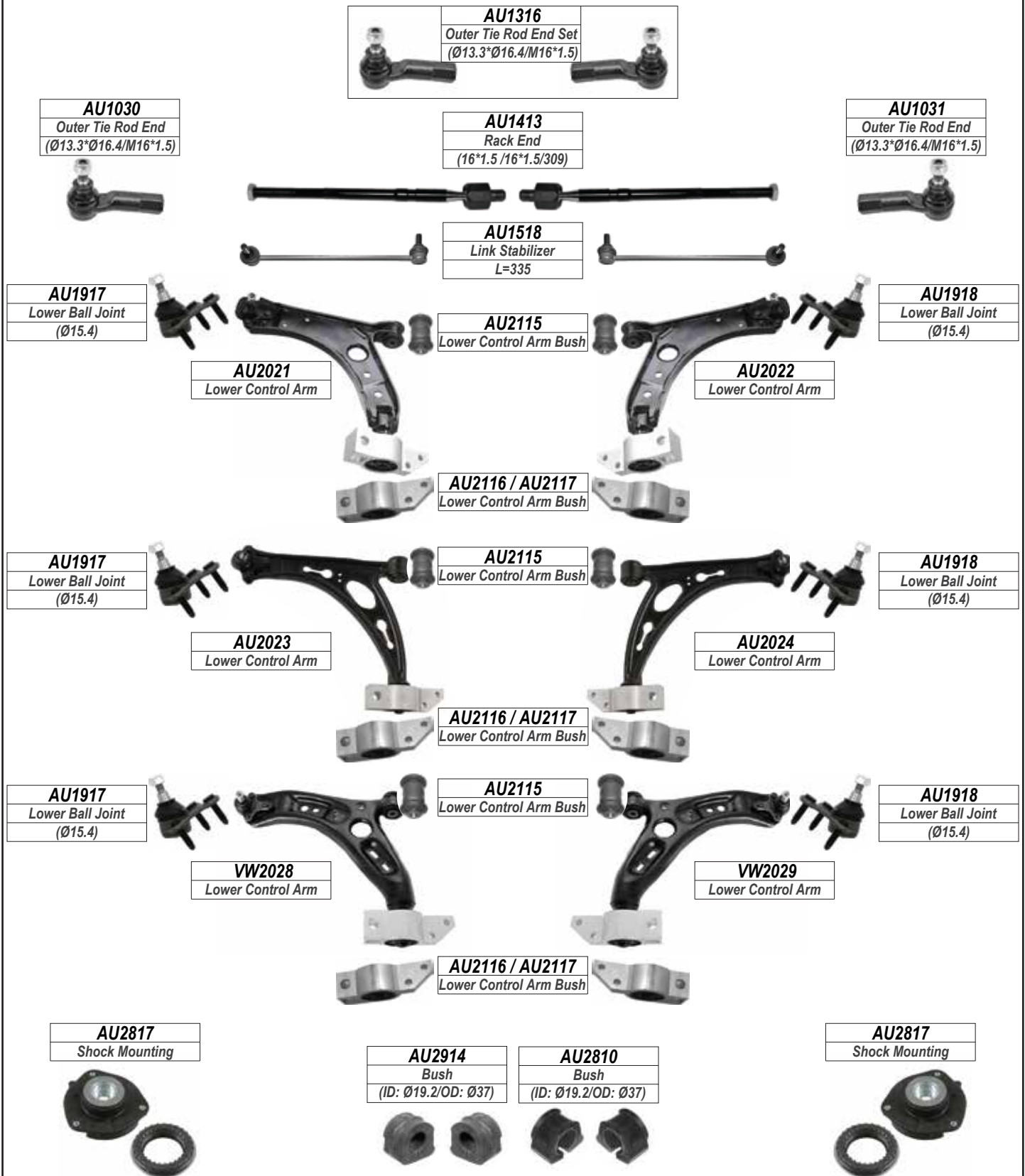

LEFT

RIGHT

VOLKSWAGEN

GOLF V / VI

REAR

ALL MODELS

Year

2004-2012

AU1519
Link Stabilizer
L=95.5



AU2915
Bush
(ID: Ø14.3/OD: Ø24.3)



VW2911
Bush



VW2911
Bush

AU2610
Lateral Link

AU2610
Lateral Link

AU1710
Upper Control Arm



AU2080 / AU2081
Lower Control Arm



VW2114
Lower Control Arm Bush



VW2014
Lower Control Arm



VW2014
Lower Control Arm

AU2818
Shock Mounting



AU2818
Shock Mounting



LEFT

RIGHT

VOLKSWAGEN

GOLF VII

FRONT

ALL MODELS

Year

2012-

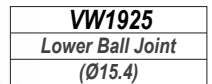
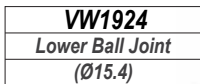
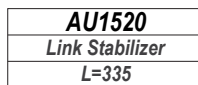
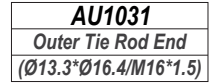
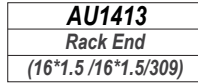
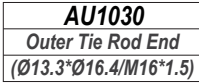
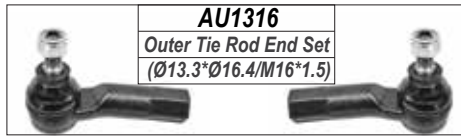

GOLF VII

REAR

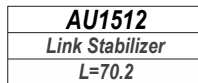

LEFT

RIGHT

VOLKSWAGEN

JETTA I

FRONT

ALL MODELS

Year

1980-1985

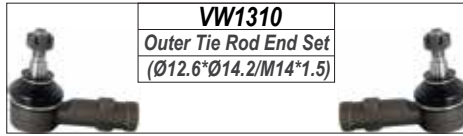

VW1310
Outer Tie Rod End Set
(Ø12.6*Ø14.2/M14*1.5)

VW1012
Outer Tie Rod End
(Ø12.6*Ø14.2/M14*1.5)

VW1414
Rack End
(22*1.5 /14*1.5/341)

VW1012
Outer Tie Rod End
(Ø12.6*Ø14.2/M14*1.5)



VW1512
Link Stabilizer
L=75



VW1911
Lower Ball Joint
(Ø17)



VW1911
Lower Ball Joint
(Ø17)



VW2115
Lower Control Arm Bush



VW1914
Lower Ball Joint
(Ø15)



VW2015
Lower Control Arm

VW2016
Lower Control Arm

VW1914
Lower Ball Joint
(Ø15)



VW2821
Shock Mounting



VW2116
Lower Control Arm Bush



VW2821
Shock Mounting



JETTA I

REAR

VW2823
Shock Mounting
ID:18 H:84



VW2823
Shock Mounting
ID:18 OD:29



VW2824
Shock Mounting
ID:31 H:38



VW2824
Shock Mounting
ID:31 H:38



LEFT

RIGHT

VOLKSWAGEN

JETTA II

FRONT

ALL MODELS

Year

1985-1992

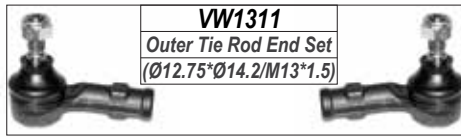

VW1311
Outer Tie Rod End Set
(Ø12.75*Ø14.2/M13*1.5)

VW1013
Outer Tie Rod End
(Ø12.75*Ø14.2/M13*1.5)

VW1415
Rack End
(22*1.5/14*1.5/368)(M/S)

VW1014
Outer Tie Rod End
(Ø12.75*Ø14.2/M13*1.5)



VW1416
Rack End
(14*1.5/14*1.5/340)(P/S)



VW1512
Link Stabilizer
L=75



VW1915
Lower Ball Joint
(Ø17)



VW1915
Lower Ball Joint
(Ø17)



VW2021
Lower Control Arm

VW2022
Lower Control Arm

AU2113
Lower Control Arm Bush

VW2117
Lower Control Arm Bush

VW1926
Lower Ball Joint
(Ø19)



VW1926
Lower Ball Joint
(Ø19)



VW2023
Lower Control Arm

VW2024
Lower Control Arm

AU2113
Lower Control Arm Bush

VW2117
Lower Control Arm Bush

VW1916
Lower Ball Joint
(Ø19)



VW1916
Lower Ball Joint
(Ø19)



VW2822
Shock Mounting



VW2813
Stabilizer Bar Bush
ID:17 OD:35



VW2814
Stabilizer Bar Bush
ID:19 OD:37



VW2822
Shock Mounting

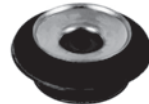

JETTA II

REAR

VW2823
Shock Mounting
ID:18 H:84



VW2824
Shock Mounting
ID:31 H:38



VW2914
Bush



VW2824
Shock Mounting
ID:31 H:38



VW2823
Shock Mounting
ID:18 OD:29



LEFT

RIGHT

VOLKSWAGEN
JETTA III
FRONT
ALL MODELS

Year

1992-1999

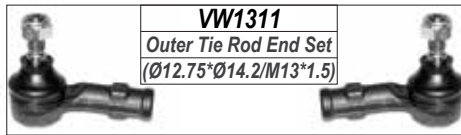
VW1311
 Outer Tie Rod End Set
 (Ø12.75*Ø14.2/M13*1.5)

VW1013
 Outer Tie Rod End
 (Ø12.75*Ø14.2/M13*1.5)

VW1417
 Rack End
 (22*1.5/14*1.5/381)(M/S)

VW1014
 Outer Tie Rod End
 (Ø12.75*Ø14.2/M13*1.5)

VW1418
 Rack End
 (14*1.5/14*1.5/369)(P/S)

VW1512
 Link Stabilizer
 L=75

AU2914
 Stabilizer Bar Bush
 (ID: Ø19.2/OD: Ø37)

AU2810
 Bush
 (ID: Ø19.2/OD: Ø37)

VW2814
 Stabilizer Bar Bush
 ID:19 OD:37

VW1512
 Link Stabilizer
 L=75

VW1514
 Link Stabilizer
 L=51

VW1514
 Link Stabilizer
 L=51

VW1515
 Link Stabilizer
 L=78

VW1515
 Link Stabilizer
 L=78

VW1926
 Lower Ball Joint
 (Ø19)

AU2113
 Lower Control Arm Bush

VW1926
 Lower Ball Joint
 (Ø19)

VW2117
 Lower Control Arm Bush

VW1916
 Lower Ball Joint
 (Ø19)

VW2050
 Lower Control Arm

VW2051
 Lower Control Arm

VW1916
 Lower Ball Joint
 (Ø19)

VW1917
 Lower Ball Joint
 (Ø16.5)(VR6 Only)

AU2113
 Lower Control Arm Bush

VW1917
 Lower Ball Joint
 (Ø16.5)(VR6 Only)

VW2825
 Shock Mounting

VW2026
 Lower Control Arm
 VR6 Only

VW2027
 Lower Control Arm
 VR6 Only

VW2825
 Shock Mounting

VW2117
 Lower Control Arm Bush

GOLF III
REAR
VW2823
 Shock Mounting
 ID:18 H:84

VW2824
 Shock Mounting
 ID:31 H:38

VW2914
 Bush

VW2824
 Shock Mounting
 ID:31 H:38

VW2823
 Shock Mounting
 ID:18 OD:29

LEFT

RIGHT

VOLKSWAGEN

JETTA IV

FRONT

ALL MODELS

Year

1999-2005

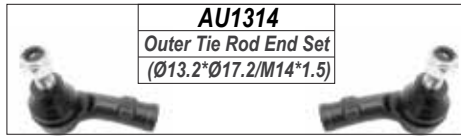

AU1314
Outer Tie Rod End Set
(Ø13.2*Ø17.2/M14*1.5)

AU1018
Outer Tie Rod End
(Ø13.2*Ø17.2/M14*1.5)

AU1412
Rack End
(16*1.5 /14*1.5/341)

AU1019
Outer Tie Rod End
(Ø13.2*Ø17.2/M14*1.5)

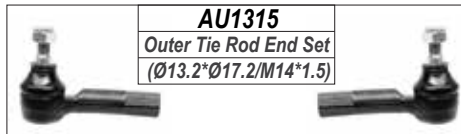

AU1315
Outer Tie Rod End Set
(Ø13.2*Ø17.2/M14*1.5)

AU1020
Outer Tie Rod End
(Ø13.2*Ø17.2/M14*1.5)

AU1411
Rack End
(16*1.5 /14*1.5/320)

AU1021
Outer Tie Rod End
(Ø13.2*Ø17.2/M14*1.5)

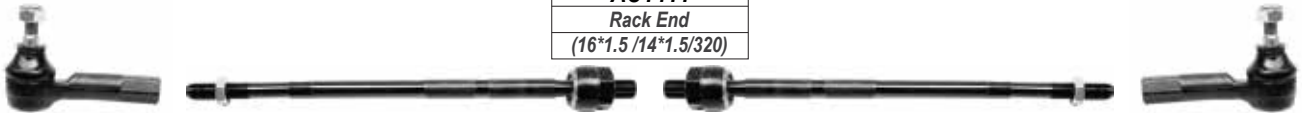

AU1915
Lower Ball Joint
(Ø14.9)



AU2113
Lower Control Arm Bush



AU1916
Lower Ball Joint
(Ø14.9)

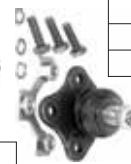

AU2019
Lower Control Arm

AU2020
Lower Control Arm

AU1513
Link Stabilizer
L=105.5



AU1513
Link Stabilizer
L=105.5



AU1514
Link Stabilizer
L=105.5



AU2114
Lower Control Arm Bush



AU1514
Link Stabilizer
L=105.5



AU1545
Link Stabilizer
L=335



AU2810
Stabilizer Bar Bush



AU1546
Link Stabilizer
L=335



AU2814
Shock Mounting



AU2814
Shock Mounting



LEFT

RIGHT

VOLKSWAGEN

JETTA IV

REAR

ALL MODELS

Year

1999-2005

AU1517

Link Stabilizer

L=175

VW2910

Bush



VW2910

Bush



VW2610

Lateral Link



VW2610

Lateral Link



VW2611

Lateral Link



VW2611

Lateral Link

AU2913

Bush

(ID: Ø12.2/OD: Ø50)



AU2912

Bush

(ID: Ø12.2/OD: Ø71.5)



AU2815

Shock Mounting



AU2815

Shock Mounting



LEFT

RIGHT

VOLKSWAGEN
JETTA V
FRONT
ALL MODELS

Year

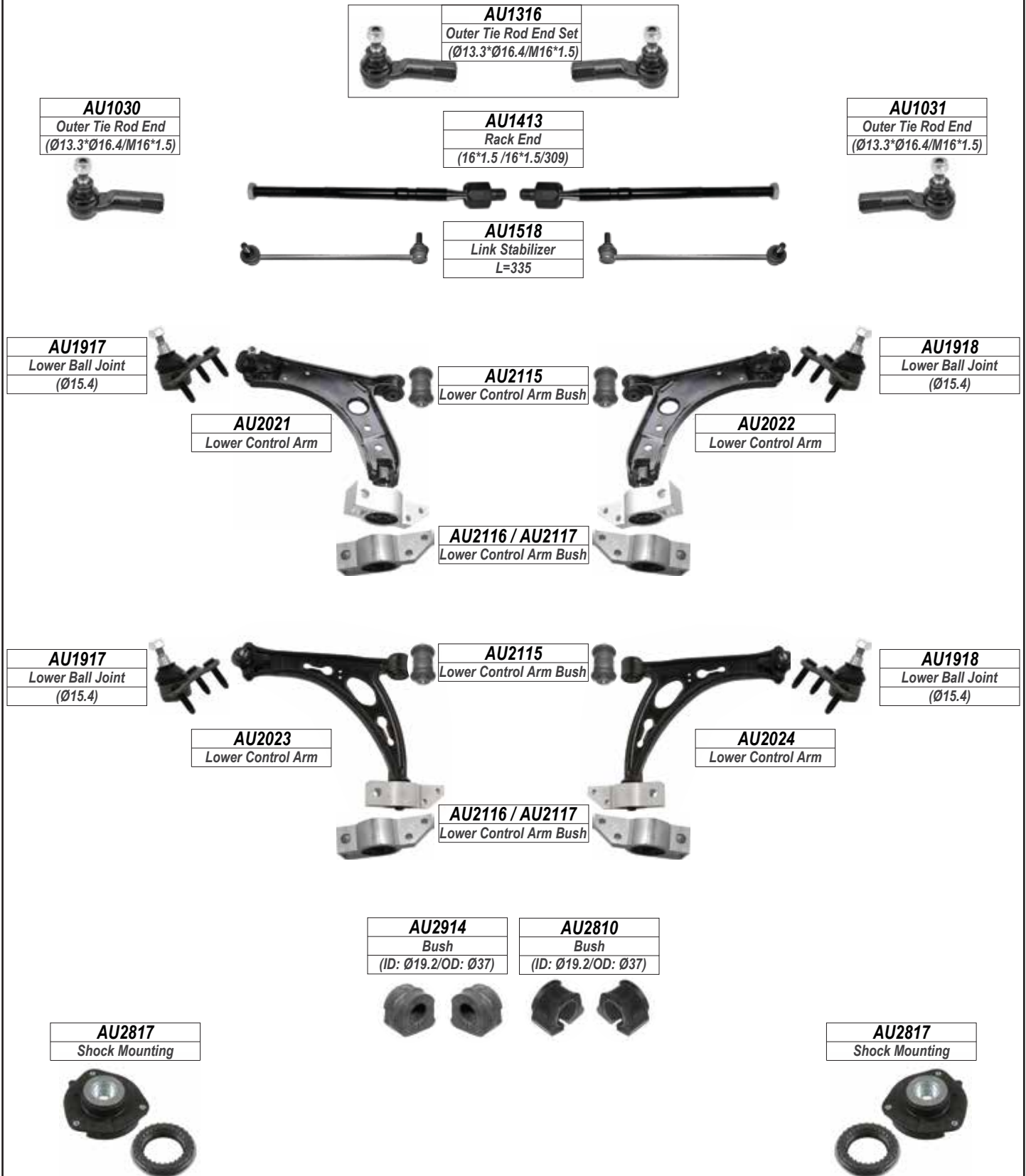
2005-

LEFT
RIGHT

VOLKSWAGEN

JETTA V

REAR

ALL MODELS

Year

2005-

AU1519
Link Stabilizer
L=95.5



AU2915
Bush
(ID: Ø14.3/OD: Ø24.3)

VW2911
Bush



VW2911
Bush

AU2610
Lateral Link

AU2610
Lateral Link

AU1710
Upper Control Arm



AU2080 / AU2081
Lower Control Arm



VW2114
Lower Control Arm Bush



VW2014
Lower Control Arm

VW2014
Lower Control Arm

AU2818
Shock Mounting



AU2818
Shock Mounting



LEFT

RIGHT

VOLKSWAGEN

JETTA VI

FRONT

ALL MODELS

Year

2010-

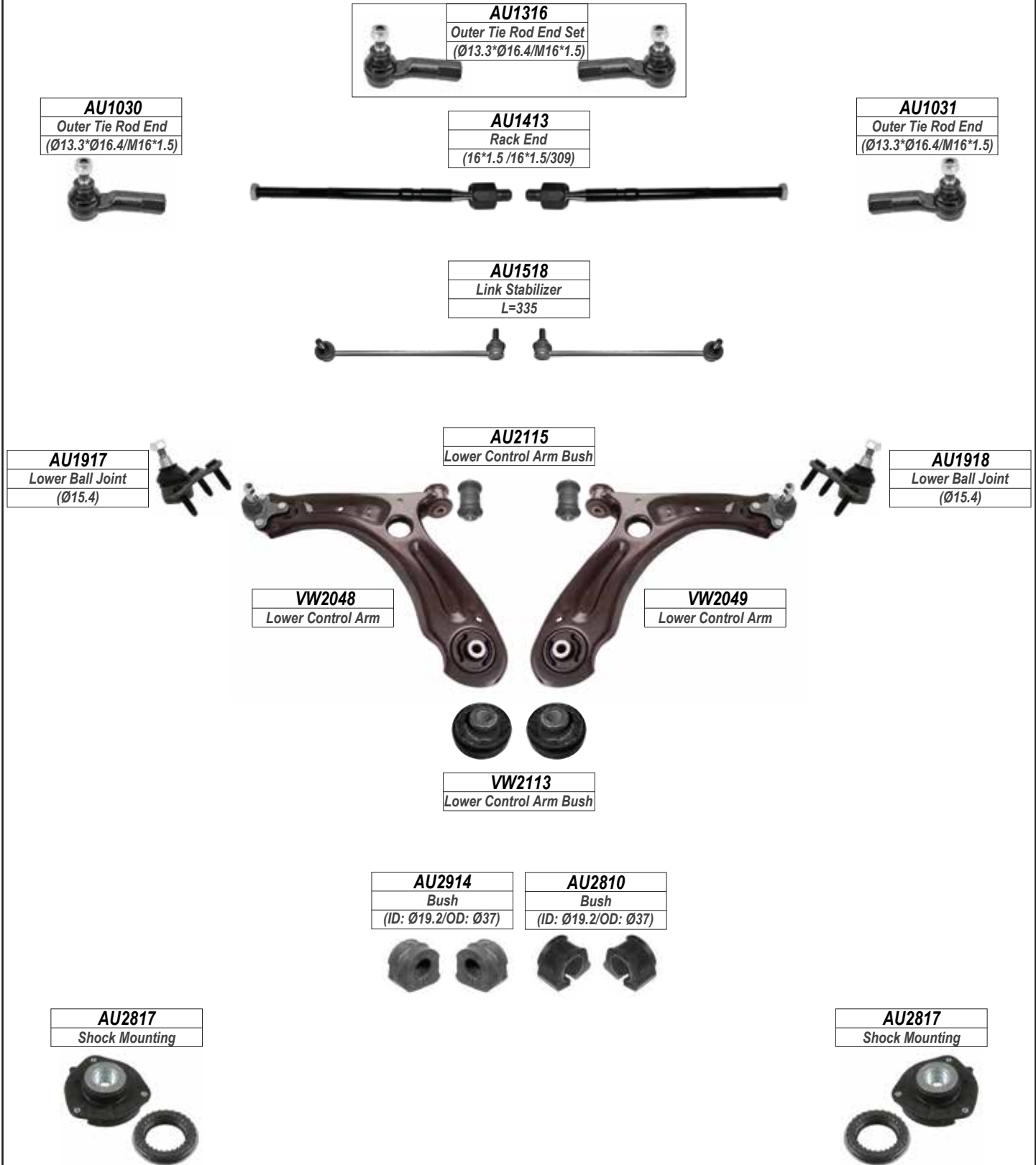

LEFT

RIGHT

VOLKSWAGEN

JETTA VI

REAR

ALL MODELS

Year

2010-

AU1519
Link Stabilizer
L=95.5



AU2915
Bush
(ID: Ø14.3/OD: Ø24.3)



VW2911
Bush



AU2610
Lateral Link



AU2610
Lateral Link



VW2911
Bush



AU1710
Upper Control Arm



AU2080 / AU2081
Lower Control Arm



VW2114
Lower Control Arm Bush



VW2014
Lower Control Arm



VW2014
Lower Control Arm



AU2818
Shock Mounting



AU2818
Shock Mounting



LEFT

RIGHT

VOLKSWAGEN

KOMBI (T2) (T3) FRONT

ALL MODELS

Year

1979-1992

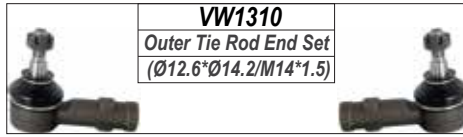

VW1310
Outer Tie Rod End Set
(Ø12.6*Ø14.2/M14*1.5)

VW1012
Outer Tie Rod End
(Ø12.6*Ø14.2/M14*1.5)

VW1419
Rack End
(14*1.5/14*1.5/379)

VW1012
Outer Tie Rod End
(Ø12.6*Ø14.2/M14*1.5)



VW1811
Upper Control Arm Bush
ID:18.5 OD:36-54 L:54



VW1611
Lower Ball Joint
(Ø18.1)



VW1611
Lower Ball Joint
(Ø18.1)



VW1918
Lower Ball Joint
(Ø19.7)



VW1918
Lower Ball Joint
(Ø19.7)



VW2915
Bush
ID:13 OD:26 L:28



VW2916
Bush
ID:9 OD:28 L:28



LEFT

RIGHT

VOLKSWAGEN

KOMBI (T4)

FRONT

ALL MODELS

Year

1999-2004

<p>VW1015 Outer Tie Rod End (Ø14.6*Ø18.2/M16*1.5)</p>	<p>VW1312 Outer Tie Rod End Set (Ø14.6*Ø18.2/M16*1.5)</p>	<p>VW1016 Outer Tie Rod End (Ø14.6*Ø18.2/M16*1.5)</p>
<p>VW1019 Outer Tie Rod End (Ø14.75*Ø16.2/M16*1.5)</p>	<p>VW1314 Outer Tie Rod End Set (Ø14.75*Ø16.2/M16*1.5)</p>	
<p>VW1612 Upper Ball Joint (Ø17.9)</p>	<p>VW1420 Rack End (14*1.5/16*1.5/293)</p>	<p>VW1020 Outer Tie Rod End (Ø14.75*Ø16.2/M16*1.5)</p>
<p>VW1919 Lower Ball Joint (Ø20.3)(Width:104)</p>	<p>VW1421 Rack End (14*1.5/16*1.5/294)</p>	<p>VW1612 Upper Ball Joint (Ø17.9)</p>
<p>VW1920 Lower Ball Joint (Ø20.3)(Width:102)</p>	<p>VW1516 Link Stabilizer L=108</p>	<p>VW1919 Lower Ball Joint (Ø20.3)(Width:104)</p>
<p>VW2816 Stabilizer Bar Bush ID:22 L:31</p>	<p>VW1517 Link Stabilizer L=108</p>	<p>VW1920 Lower Ball Joint (Ø20.3)(Width:102)</p>
<p>VW2817 Stabilizer Bar Bush ID:20 OD:35 L:29</p>	<p>VW2118 Lower Control Arm Bush</p>	<p>VW2031 Lower Control Arm Short (L:360)</p>
	<p>VW2119 Lower Control Arm Bush</p>	<p>VW2033 Lower Control Arm Long (L:381)</p>
	<p>VW2118 Lower Control Arm Bush</p>	
	<p>VW2119 Lower Control Arm Bush</p>	<p>VW2917 Upper Control Arm Bush ID:12 OD:39 L:60</p>
		<p>VW2918 Upper Control Arm Bush ID:14 OD:35 L:60</p>

LEFT

RIGHT

VOLKSWAGEN

KOMBI (T5)

FRONT

ALL MODELS

Year

2004-

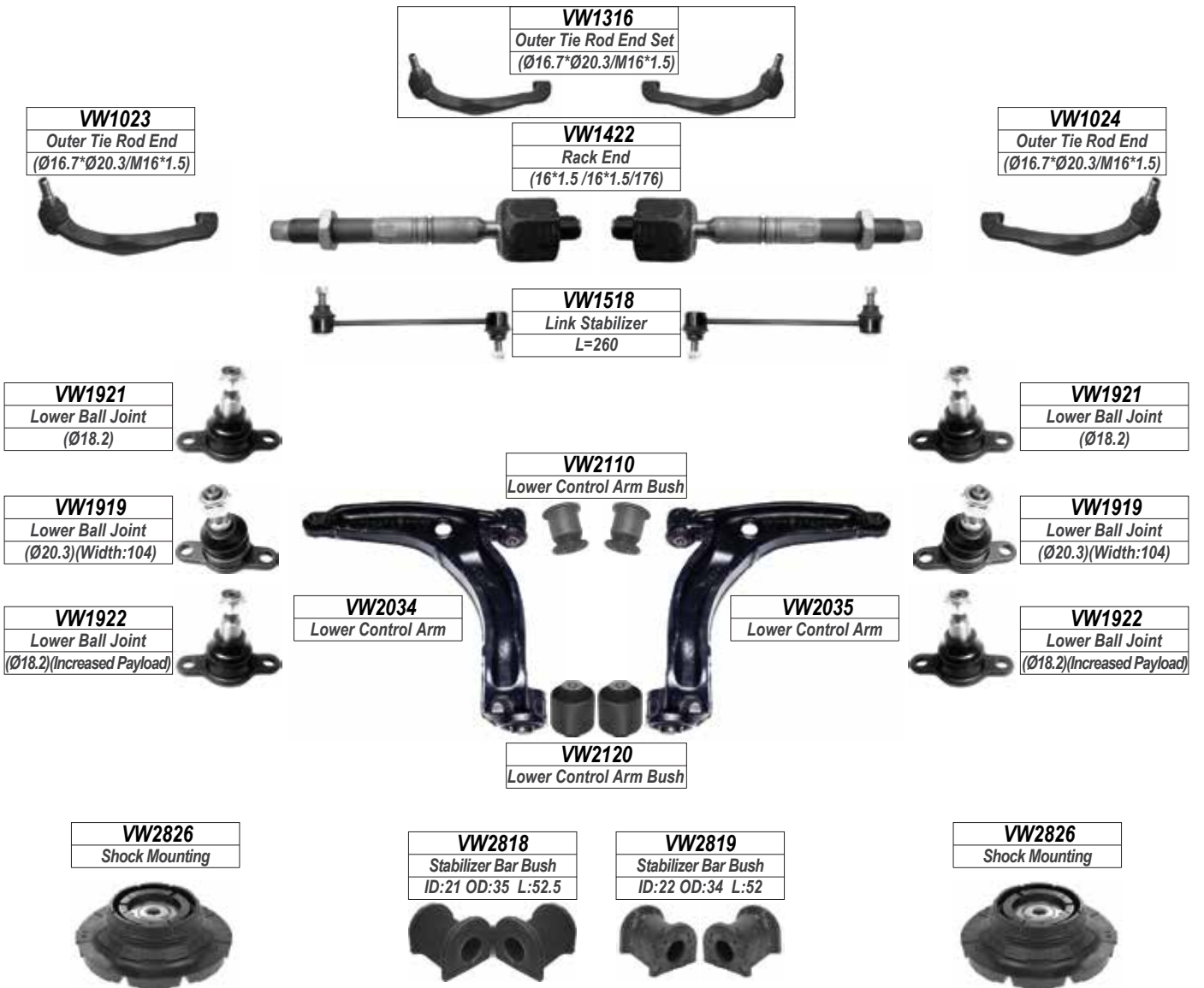

KOMBI (T5)

REAR

VW2920
Bush
ID:21 L:43



VW2921
Bush
ID:23 L:44



LEFT

RIGHT

VOLKSWAGEN

LT

FRONT

28-35-46

Year

1996-

ME1050
Outer Tie Rod End
(Ø18.2*Ø20.5/M16*1.5)

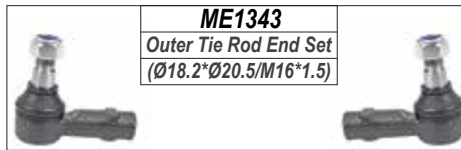

ME1343
Outer Tie Rod End Set
(Ø18.2*Ø20.5/M16*1.5)

ME1421
Rack End
(16*1.5/16*1.5/385)

ME1050
Outer Tie Rod End
(Ø18.2*Ø20.5/M16*1.5)



ME1579 / ME1580
Link Stabilizer
L=115

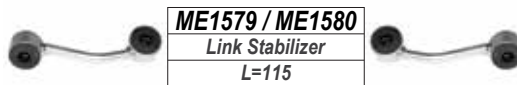

ME1930
Lower Ball Joint
(Ø23.5)



ME2147
Lower Control Arm Bush

ME2077
Lower Control Arm

ME2078
Lower Control Arm

ME1930
Lower Ball Joint
(Ø23.5)



ME2815
Shock Mounting(Upper)



ME2815
Shock Mounting(Upper)



ME2826
Shock Mounting(Lower)



ME2826
Shock Mounting(Lower)



LT

REAR

ME1581
Link Stabilizer
L=94.5



LEFT

RIGHT

VOLKSWAGEN

PASSAT V

FRONT

ALL MODELS

Year

1999-2005

AU1022
Outer Tie Rod End
(Ø13.6*Ø14.8/M14*1.5)



AU1523
Link Stabilizer
L=86



AU1521
Link Stabilizer
L=90



AU2120
Lower Control Arm Bush
(ID:Ø12.2/OD:40.2/L=50)



AU2120
Lower Control Arm Bush
(ID:Ø12.2/OD:40.2/L=50)



AU2819
Shock Mounting



AU2824
Shock Mounting

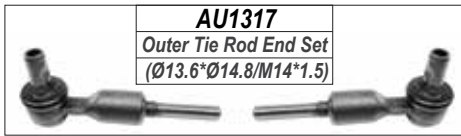

AU1317
Outer Tie Rod End Set
(Ø13.6*Ø14.8/M14*1.5)

AU1414
Rack End
(16*1.5 /14*1.5/128)



AU1810
Upper Control Arm Bush



AU1810
Upper Control Arm Bush



AU2121
Lower Control Arm Bush



AU2121
Lower Control Arm Bush



AU2119
Lower Control Arm Bush



AU1022
Outer Tie Rod End
(Ø13.6*Ø14.8/M14*1.5)



AU1523
Link Stabilizer
L=86



AU1522
Link Stabilizer
L=90



AU2120
Lower Control Arm Bush
(ID:Ø12.2/OD:40.2/L=50)



AU2120
Lower Control Arm Bush
(ID:Ø12.2/OD:40.2/L=50)



AU2819
Shock Mounting



AU2824
Shock Mounting



AU1711
Upper Control Arm



AU1713
Upper Control Arm



AU2029
Lower Control Arm
(Ø20.6)

AU2029
Lower Control Arm
(Ø20.6)



AU2033
Lower Control Arm
(Ø16.3)

AU2033
Lower Control Arm
(Ø16.3)



AU2030
Lower Control Arm

AU2031
Lower Control Arm

PASSAT V

REAR

AU2824
Shock Mounting



AU1531
Link Stabilizer
L=57.4



AU2824
Shock Mounting



LEFT

RIGHT

VOLKSWAGEN
PASSAT VI FRONT

ALL MODELS

Year

2005-2011

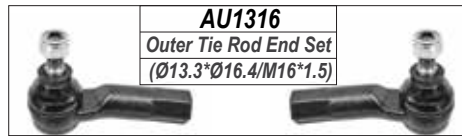

AU1316
Outer Tie Rod End Set
(Ø13.3*Ø16.4/M16*1.5)

AU1030
Outer Tie Rod End
(Ø13.3*Ø16.4/M16*1.5)

VW1413
Rack End
(16*1.5/16*1.5/329)

AU1031
Outer Tie Rod End
(Ø13.3*Ø16.4/M16*1.5)

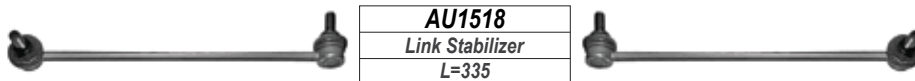

AU1518
Link Stabilizer
L=335

VW1912
Lower Ball Joint
(Ø15.3)



AU2115
Lower Control Arm Bush



VW1913
Lower Ball Joint
(Ø15.3)



VW2019
Lower Control Arm

VW2020
Lower Control Arm

AU2817
Shock Mounting



AU2817
Shock Mounting



AU2134
Lower Control Arm Bush

PASSAT VI REAR

AU2915
Bush
(ID: Ø14.3/OD: Ø24.3)

VW2911
Bush



VW2911
Bush

AU2610
Lateral Link

AU2610
Lateral Link



AU1710
Upper Control Arm



AU1519
Link Stabilizer
L=95.5



VW2114
Lower Control Arm Bush

AU1519
Link Stabilizer
L=95.5



VW2014
Lower Control Arm

VW2014
Lower Control Arm



AU2080 / AU2081
Lower Control Arm

LEFT

RIGHT

VOLKSWAGEN

PASSAT VII

FRONT

ALL MODELS

Year

2010-

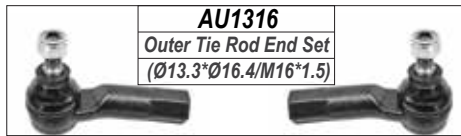

AU1030
Outer Tie Rod End
(Ø13.3*Ø16.4/M16*1.5)

VW1413
Rack End
(16*1.5/16*1.5/329)

AU1031
Outer Tie Rod End
(Ø13.3*Ø16.4/M16*1.5)



AU1413
Rack End
(16*1.5/16*1.5/309)



AU1518
Link Stabilizer
L=335

AU2115
Lower Control Arm Bush



VW2038
Lower Control Arm

VW2039
Lower Control Arm

AU1917
Lower Ball Joint
(Ø15.4)



AU2134
Lower Control Arm Bush

AU1918
Lower Ball Joint
(Ø15.4)



AU2115
Lower Control Arm Bush



VW2012
Lower Control Arm

VW2013
Lower Control Arm

VW2113
Lower Control Arm Bush

PASSAT VII

REAR

AU1519
Link Stabilizer
L=95.5



LEFT

RIGHT

VOLKSWAGEN

POLO I

FRONT

CLASSIC.PLAYA

Year

1995-2003

VW1013
Outer Tie Rod End
(Ø12.75*Ø14.2/M14*1.5)

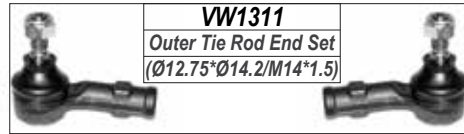

VW1311
Outer Tie Rod End Set
(Ø12.75*Ø14.2/M14*1.5)

VW1423
Rack End
(14*1.5*14*1.5/296)

VW1014
Outer Tie Rod End
(Ø12.75*Ø14.2/M14*1.5)



VW1025
Outer Tie Rod End
(Ø12.75*Ø14.2/M14*1.5)

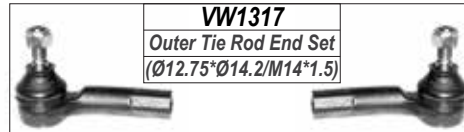

VW1317
Outer Tie Rod End Set
(Ø12.75*Ø14.2/M14*1.5)

VW1416
Rack End
(14*1.5/14*1.5/340)

VW1026
Outer Tie Rod End
(Ø12.75*Ø14.2/M14*1.5)

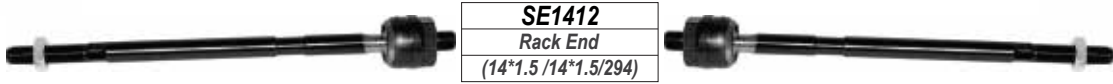

SE1412
Rack End
(14*1.5 /14*1.5/294)

SE1412
Rack End
(14*1.5 /14*1.5/294)

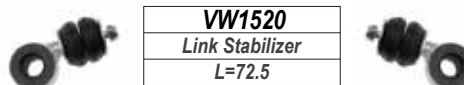

VW1520
Link Stabilizer
L=72.5

VW1926
Lower Ball Joint
(Ø19)



AU2113
Lower Control Arm Bush



VW1926
Lower Ball Joint
(Ø19)

VW1916
Lower Ball Joint
(Ø19)



VW2023
Lower Control Arm

VW2024
Lower Control Arm



VW1916
Lower Ball Joint
(Ø19)

VW2825
Shock Mounting



VW2117
Lower Control Arm Bush



VW2825
Shock Mounting



POLO I

REAR

VW2823
Shock Mounting
ID:18 H:84



VW2824
Shock Mounting
ID:31 H:38



VW2824
Shock Mounting
ID:31 H:38



VW2823
Shock Mounting
ID:18 OD:29



LEFT

RIGHT

VOLKSWAGEN

POLO II

FRONT

ALL MODELS

Year

2003-2009

AU1020
Outer Tie Rod End
(Ø13.2*Ø17.2/M14*1.5)

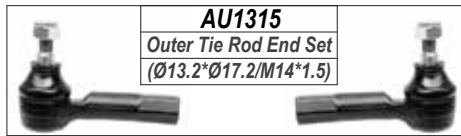

AU1315
Outer Tie Rod End Set
(Ø13.2*Ø17.2/M14*1.5)

AU1021
Outer Tie Rod End
(Ø13.2*Ø17.2/M14*1.5)



AU1016
Outer Tie Rod End
(Ø13.2*Ø17.2/M14*1.5)

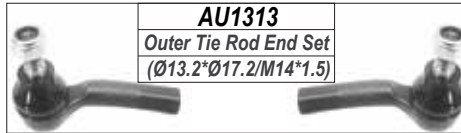

AU1313
Outer Tie Rod End Set
(Ø13.2*Ø17.2/M14*1.5)

AU1017
Outer Tie Rod End
(Ø13.2*Ø17.2/M14*1.5)



VW1424
Rack End
(14*1.5/14*1.5/297)



SE1412
Rack End
(14*1.5/14*1.5/294)



VW1416
Rack End
(14*1.5/14*1.5/340)



AU1511
Link Stabilizer
L=271



SE1910
Lower Ball Joint
(Ø14.9)



SE2010
Lower Control Arm

SE2110
Lower Control Arm Bush



SE2010
Lower Control Arm

SE1911
Lower Ball Joint
(Ø14.9)



VW2827
Shock Mounting



SE2111
Lower Control Arm Bush



VW2827
Shock Mounting



POLO II

REAR

AU2815
Shock Mounting



AU2912
Bush
(ID: Ø12.2/OD: Ø71.5)



AU2815
Shock Mounting



LEFT

RIGHT

VOLKSWAGEN

POLO III

FRONT

(6R) (VIVO)

Year

2009-2014

AU1020
Outer Tie Rod End
(Ø13.2*Ø17.2/M14*1.5)



AU1016
Outer Tie Rod End
(Ø13.2*Ø17.2/M14*1.5)

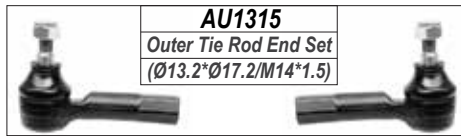

AU1315
Outer Tie Rod End Set
(Ø13.2*Ø17.2/M14*1.5)

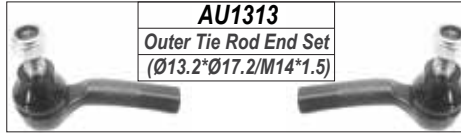

AU1313
Outer Tie Rod End Set
(Ø13.2*Ø17.2/M14*1.5)

AU1021
Outer Tie Rod End
(Ø13.2*Ø17.2/M14*1.5)



AU1017
Outer Tie Rod End
(Ø13.2*Ø17.2/M14*1.5)



VW1424
Rack End
(14*1.5/14*1.5/297)



SE1412
Rack End
(14*1.5 /14*1.5/294)



VW1416
Rack End
(14*1.5/14*1.5/340)



VW1425
Rack End
(16*1.5/14*1.5/303)



AU1410
Rack End
(14*1.5 /14*1.5/310)



AU1511
Link Stabilizer
L=271



AU2113
Lower Control Arm Bush

VW2040
Lower Control Arm

VW2041
Lower Control Arm

AU2114
Lower Control Arm Bush

AU1913
Lower Ball Joint
(Ø14.9)



AU1914
Lower Ball Joint
(Ø14.9)



AU2113
Lower Control Arm Bush



AU2114
Lower Control Arm Bush



VW2827
Shock Mounting



AU2016
Lower Control Arm

AU2114
Lower Control Arm Bush

AU2017
Lower Control Arm

VW2827
Shock Mounting



POLO III

REAR

AU2815
Shock Mounting



LEFT

RIGHT

VOLKSWAGEN

POLO III

FRONT

(6C)

Year

2014-

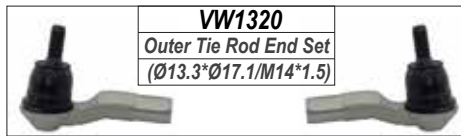

VW1320
Outer Tie Rod End Set
(Ø13.3*Ø17.1/M14*1.5)

VW1010
Outer Tie Rod End
(Ø13.3*Ø17.1/M14*1.5)



VW1410
Rack End
(14*1.5/14*1.5/312)



VW1011
Outer Tie Rod End
(Ø13.3*Ø17.1/M14*1.5)



AU1511
Link Stabilizer
L=271



AU2113
Lower Control Arm Bush

AU1913
Lower Ball Joint
(Ø14.9)



AU2016
Lower Control Arm

AU2017
Lower Control Arm

AU1914
Lower Ball Joint
(Ø14.9)



AU2814
Shock Mounting



AU2114
Lower Control Arm Bush



AU2814
Shock Mounting



POLO III

REAR

AU2815
Shock Mounting



AU2815
Shock Mounting



LEFT

RIGHT

VOLKSWAGEN

POLO IV

FRONT

AW

Year

2018-

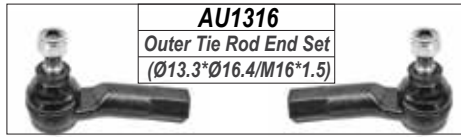

AU1030
Outer Tie Rod End
(Ø13.3*Ø16.4/M16*1.5)

VW1426
Rack End
(14*1.5/16*1.5/314)

AU1031
Outer Tie Rod End
(Ø13.3*Ø16.4/M16*1.5)



AU1511
Link Stabilizer
L=271



AU1917
Lower Ball Joint
(Ø15.4)

AU2113
Lower Control Arm Bush

AU1918
Lower Ball Joint
(Ø15.4)



VW2046
Lower Control Arm

VW2047
Lower Control Arm

VW2123
Lower Control Arm Bush

POLO IV

REAR

AU2829
Shock Mounting

AU2829
Shock Mounting



LEFT

RIGHT

VOLKSWAGEN

SCIROCCO

FRONT

ALL MODELS

Year

2009-

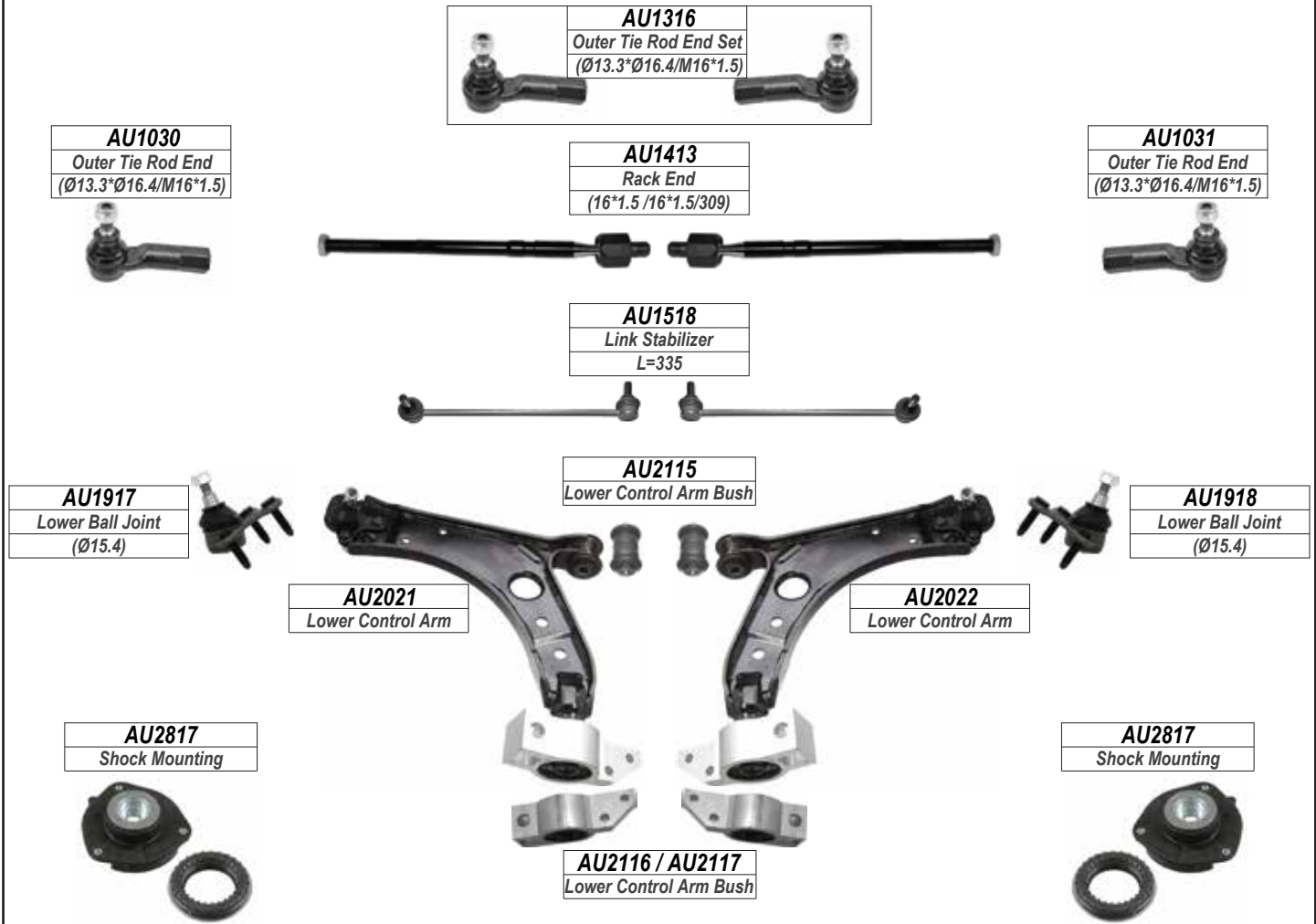

SCIROCCO

REAR



LEFT

RIGHT

VOLKSWAGEN

SHARAN

FRONT

ALL MODELS

Year

1999-

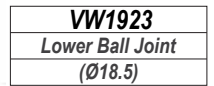
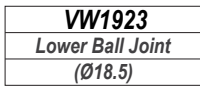
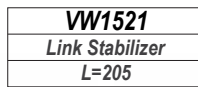
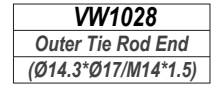
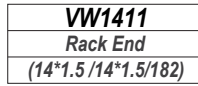

LEFT

RIGHT

VOLKSWAGEN

TIGUAN

FRONT

ALL MODELS

Year

2008-2016

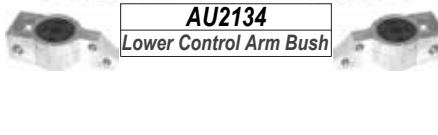
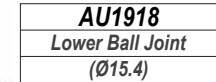
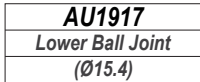
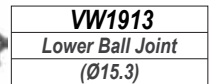
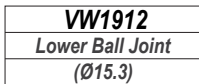
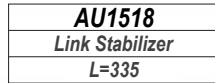
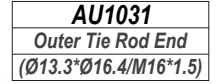
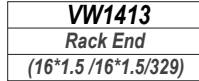
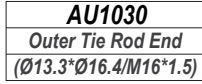
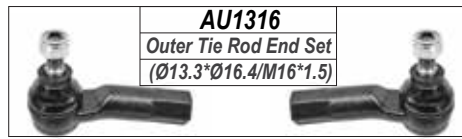

TIGUAN

REAR

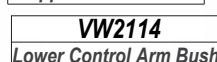
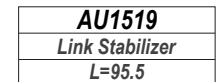
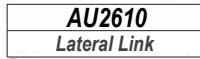
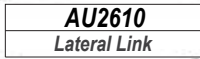
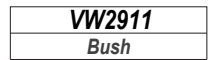
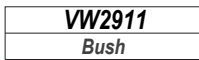
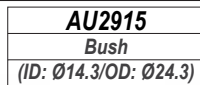

LEFT

RIGHT

VOLKSWAGEN

TIGUAN

FRONT

ALL MODELS

Year

2016-

AU1030
Outer Tie Rod End
(Ø13.3*Ø16.4/M16*1.5)

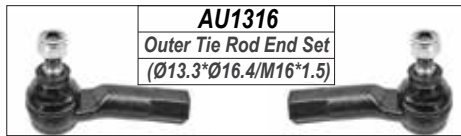

AU1413
Rack End
(16*1.5 /16*1.5/309)

AU1031
Outer Tie Rod End
(Ø13.3*Ø16.4/M16*1.5)



AU1518
Link Stabilizer
L=335



AU1520
Link Stabilizer
L=335



AU1917
Lower Ball Joint
(Ø15.4)



AU2115
Lower Control Arm Bush



AU1918
Lower Ball Joint
(Ø15.4)



VW2038
Lower Control Arm



VW2039
Lower Control Arm



AU2826
Shock Mounting



AU2826
Shock Mounting



AU2134
Lower Control Arm Bush



TIGUAN

REAR

AU2829
Shock Mounting



VW1712
Upper Control Arm



VW1712
Upper Control Arm

AU2829
Shock Mounting



VW2114
Lower Control Arm Bush



VW2014
Lower Control Arm



VW2014
Lower Control Arm



LEFT

RIGHT

VOLKSWAGEN

T-ROC

FRONT

ALL MODELS

Year

2018-

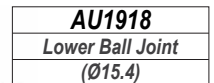
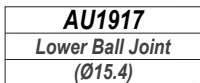
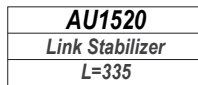
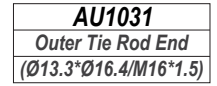
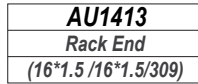
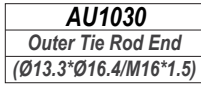
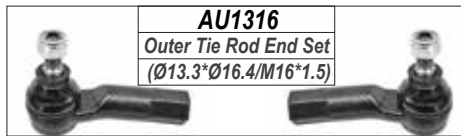

T-ROC

REAR

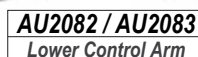
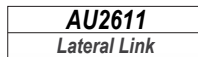
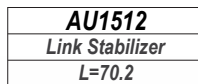

LEFT

RIGHT

VOLKSWAGEN

TOUAREG

FRONT

ALL MODELS

Year

2002-2010

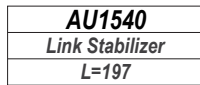
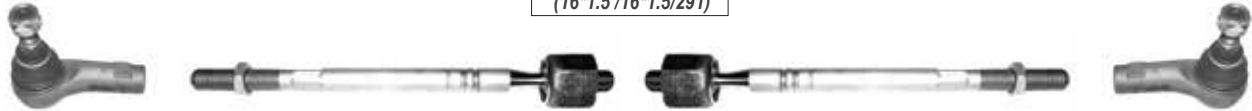
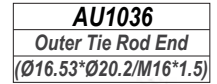
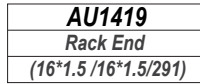
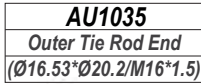
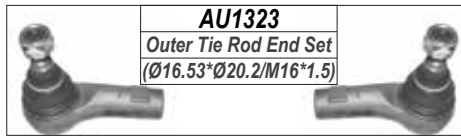

LEFT

RIGHT

VOLKSWAGEN

TOUAREG

REAR

ALL MODELS

Year

2002-2010

AU1541 / AU1542
Link Stabilizer
L=201

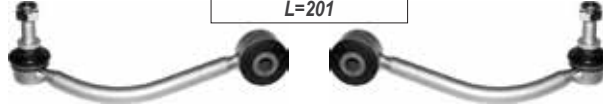

AU1543 / AU1544
Link Stabilizer
L=200



AU2811
Bush
(ID:12.2/OD:Ø40)

AU2813
Bush
(ID:12.2/OD:Ø40)



AU2813
Bush
(ID:12.2/OD:Ø40)

AU2616
Lateral Link

AU2616
Lateral Link

AU2812
Bush
(ID:16.2/OD:Ø44.3)

AU2813
Bush
(ID:12.2/OD:Ø40)



AU2813
Bush
(ID:12.2/OD:Ø40)

AU2617
Lateral Link

AU2618
Lateral Link

AU2827
Shock Mounting



AU2827
Shock Mounting



LEFT

RIGHT

VOLKSWAGEN

TOUAREG

FRONT

ALL MODELS

Year

2010-

AU1035
Outer Tie Rod End
(Ø16.53*Ø20.2/M16*1.5)

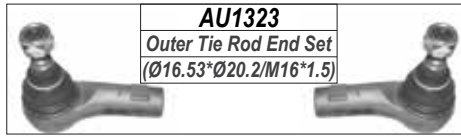

AU1323
Outer Tie Rod End Set
(Ø16.53*Ø20.2/M16*1.5)

AU1036
Outer Tie Rod End
(Ø16.53*Ø20.2/M16*1.5)



AU1419
Rack End
(16*1.5 / 16*1.5/291)



PO1810
Upper Control Arm Bush



PO1710
Upper Control Arm

PO1710
Upper Control Arm

AU2136
Lower Control Arm Bush



AU2138
Lower Control Arm Bush

AU2136
Lower Control Arm Bush

AU2828
Shock Mounting



AU2072
Lower Control Arm

AU2073
Lower Control Arm

AU2828
Shock Mounting



AU2137
Lower Control Arm Bush

TOUAREG REAR

AU2812
Bush
(ID:16.2/OD:Ø44.3)

AU2813
Bush
(ID:12.2/OD:Ø40)



AU2813
Bush
(ID:12.2/OD:Ø40)

AU2617
Lateral Link

AU2618
Lateral Link



AU1540
Link Stabilizer
L=197



AU2828
Shock Mounting



AU1541 / AU1542
Link Stabilizer
L=201



AU2828
Shock Mounting



AU1543 / AU1544
Link Stabilizer
L=200



LEFT

RIGHT

VOLKSWAGEN

TOURAN

FRONT

ALL MODELS

Year

2004-

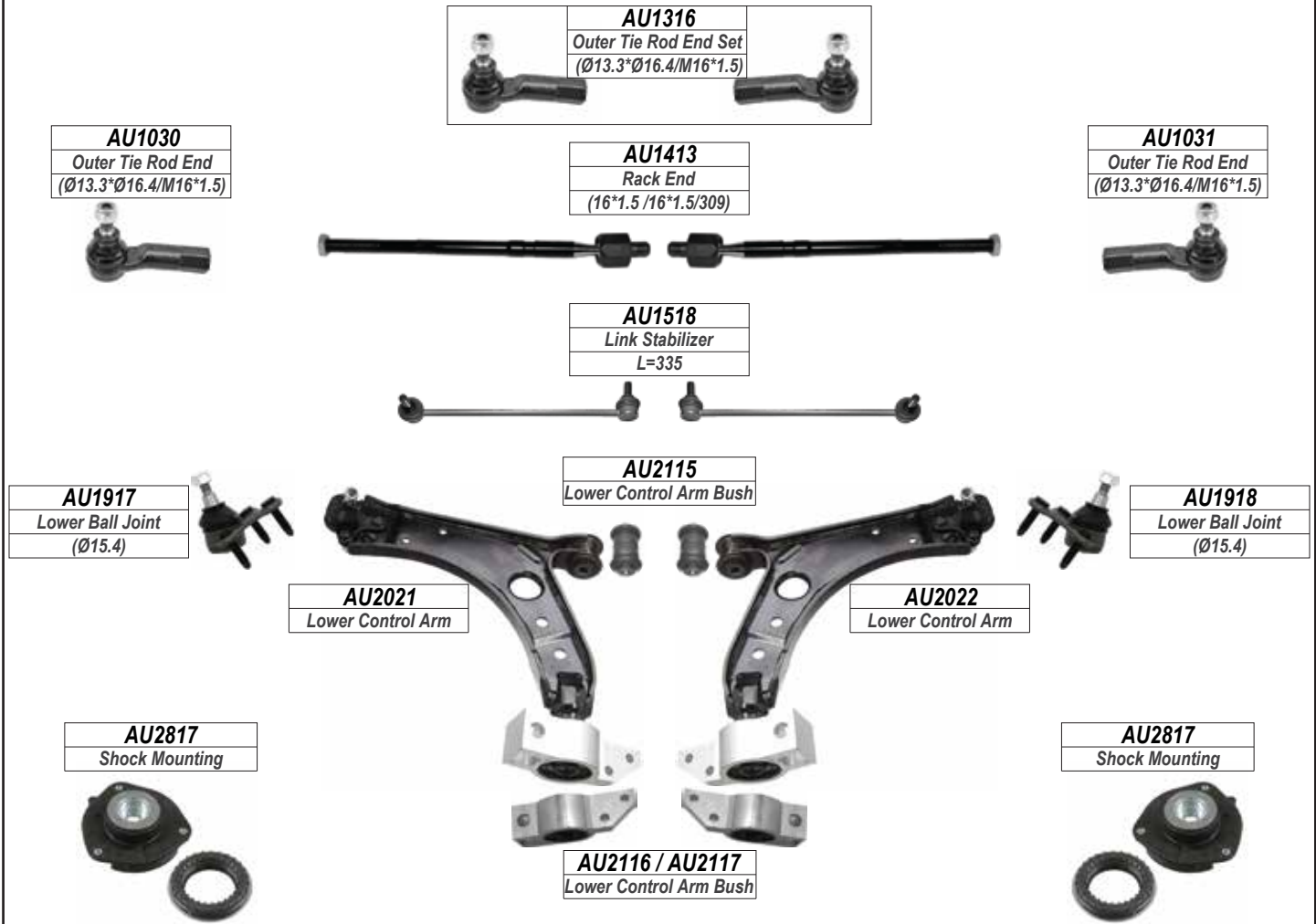

TOURAN

REAR



LEFT

RIGHT

VOLKSWAGEN

UP

FRONT

ALL MODELS

Year

2015-



VW1319
Outer Tie Rod End Set
(Ø13.3*Ø17.1/M14*1.5)

VW1029
Outer Tie Rod End
(Ø13.3*Ø17.1/M14*1.5)

VW1412
Rack End
(16*1.5 /16*1.5/291)

VW1030
Outer Tie Rod End
(Ø13.3*Ø17.1/M14*1.5)

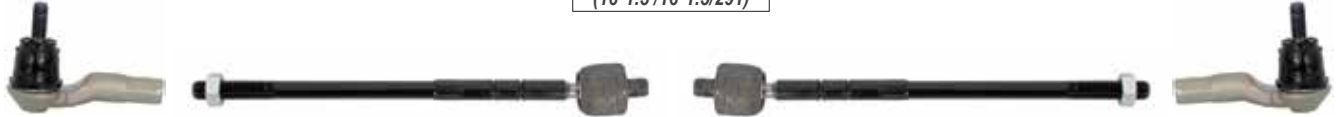

AU1511
Link Stabilizer
L=271



AU1913
Lower Ball Joint
(Ø14.9)

AU2113
Lower Control Arm Bush

AU1914
Lower Ball Joint
(Ø14.9)



VW2044
Lower Control Arm

VW2045
Lower Control Arm

AU2814
Shock Mounting

AU2814
Shock Mounting



AU2114
Lower Control Arm Bush



LEFT

RIGHT

VOLVO

850

FRONT

ALL MODELS

Year

1994-1997

VO1010
Outer Tie Rod End
(Ø12.93*Ø16.1/M14*2)



VO1011
Outer Tie Rod End
(Ø12.93*Ø16.1/M14*2)



VO1510
Link Stabilizer
L=302



VO2010
Lower Control Arm

VO2011
Lower Control Arm

VO1910
Lower Ball Joint
(Ø19)



VO1910
Lower Ball Joint
(Ø19)



LEFT

RIGHT

VOLVO

960

FRONT

ALL MODELS

Year

1994-1997

VO1010
Outer Tie Rod End
(Ø12.93*Ø16.1/M14*2)



VO1011
Outer Tie Rod End
(Ø12.93*Ø16.1/M14*2)



VO1411
Rack End
(14*1.5/14*2/288)



VO1511
Link Stabilizer
L=245



VO1911
Lower Ball Joint
(Ø15.5)



VO1911
Lower Ball Joint
(Ø15.5)



LEFT

RIGHT

VOLVO

C30

FRONT

ALL MODELS

Year

2006-2013

FO1041
Outer Tie Rod End
(Ø12.3*Ø16/M16*1.5)

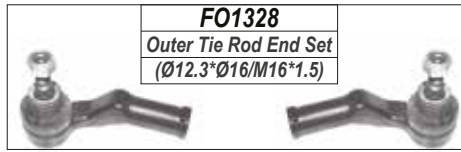

FO1328
Outer Tie Rod End Set
(Ø12.3*Ø16/M16*1.5)

FO1430
Rack End
(14*1.5/16*1.5/293)



FO1042
Outer Tie Rod End
(Ø12.3*Ø16/M16*1.5)



FO1518
Link Stabilizer
L=298



MA2110
Lower Control Arm Bush

FO1921
Lower Ball Joint
(Ø19)



FO2041
Lower Control Arm

FO2042
Lower Control Arm

FO2127
Lower Control Arm Bush

FO1921
Lower Ball Joint
(Ø19)



MA2110
Lower Control Arm Bush

FO1922
Lower Ball Joint
(Ø21)



FO2043
Lower Control Arm

FO2044
Lower Control Arm

FO2127
Lower Control Arm Bush

FO1922
Lower Ball Joint
(Ø21)



FO2826
Shock Mounting



FO2826
Shock Mounting



LEFT

RIGHT

VOLVO

C30

REAR

ALL MODELS

Year

2006-2013

FO1519
Link Stabilizer
L=110



FO1520
Link Stabilizer
L=76



FO1521
Link Stabilizer
L=109



FO2126
Lower Control Arm Bush

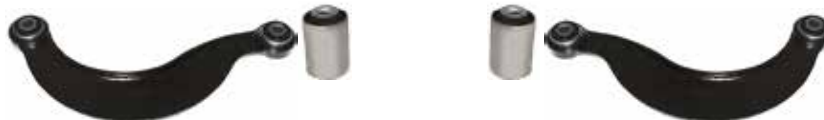

FO2040
Lower Control Arm

FO2040
Lower Control Arm



FO2045
Lower Control Arm



FO2045
Lower Control Arm

FO2911
Bush

FO2911
Bush



FO2911
Bush

FO2613
Lateral Link
L=223

FO2613
Lateral Link
L=223

FO2910
Bush



LEFT

RIGHT

VOLVO

C70

FRONT

Year

1998-2006

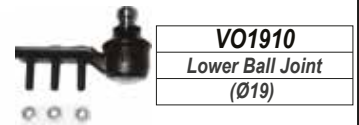
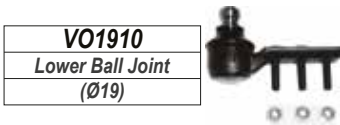
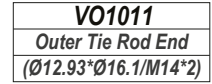
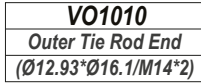

LEFT

RIGHT

VOLVO

C70

FRONT

II

Year

2006-2013

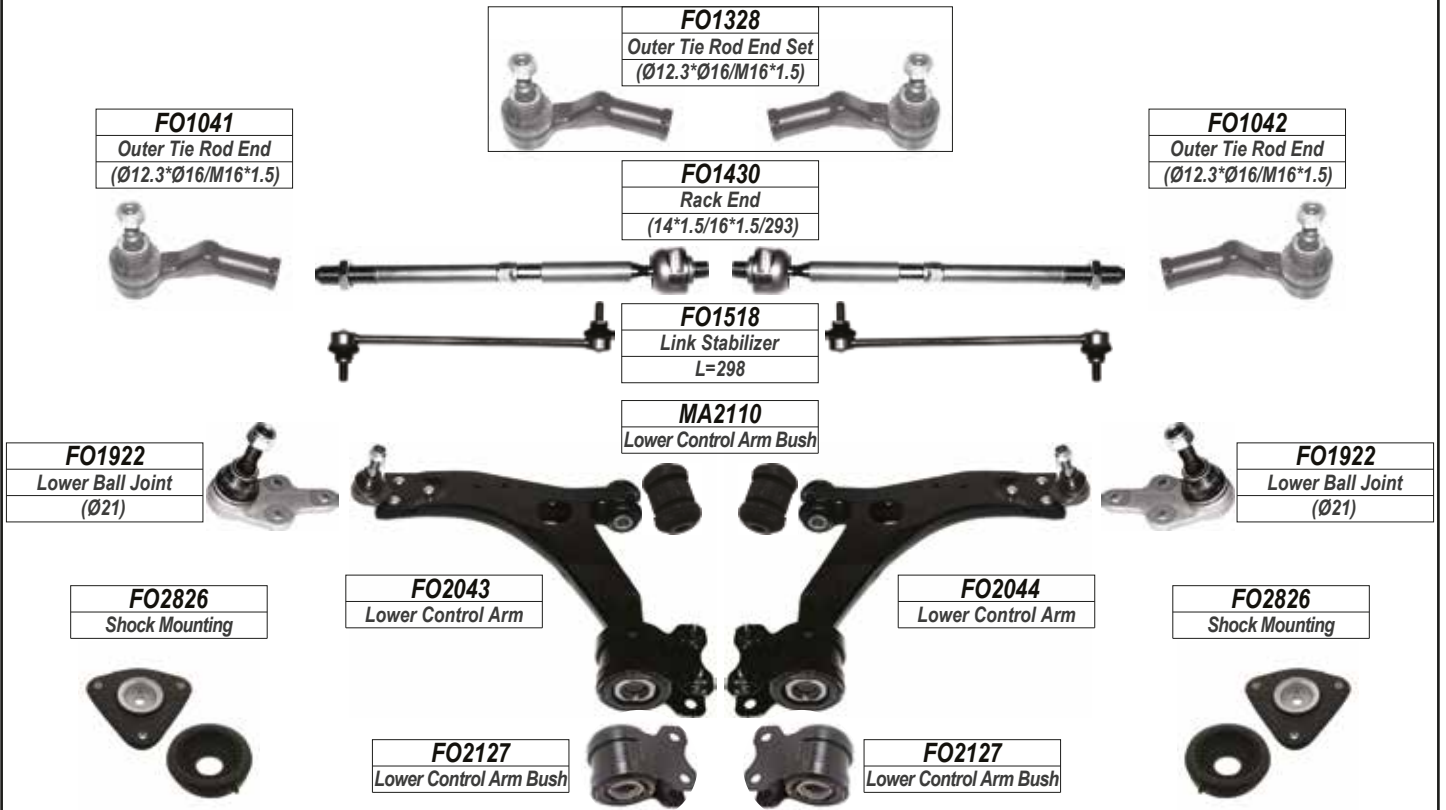

C70

REAR

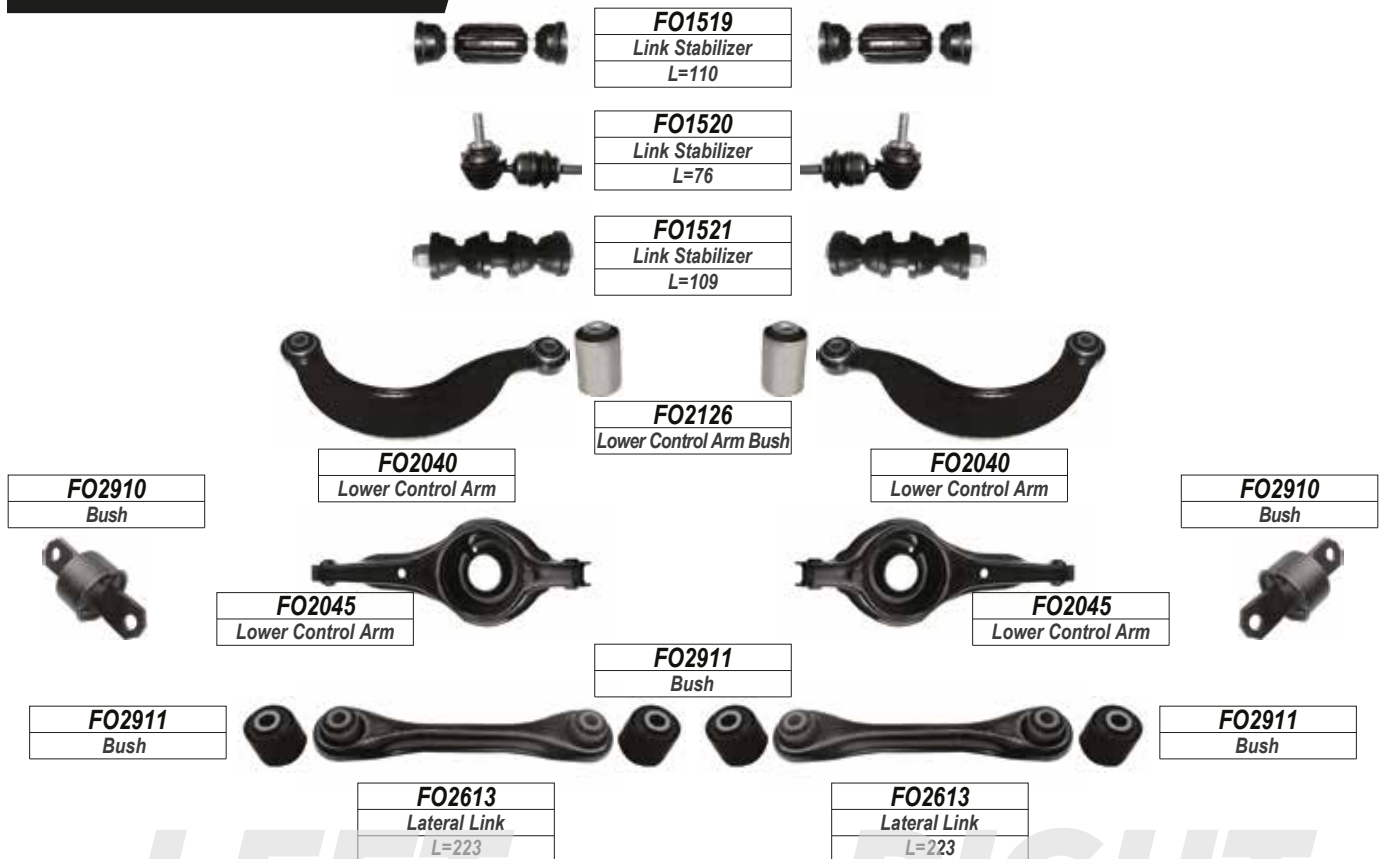

LEFT

RIGHT

VOLVO

S40 / V40

FRONT

Year

1997-2004

MI1014
Outer Tie Rod End
(Ø13.5*Ø15/M12*1.25)

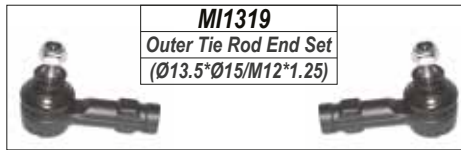

MI1319
Outer Tie Rod End Set
(Ø13.5*Ø15/M12*1.25)

MI1410
Rack End
(16*1.5/12*1.25/311)

MI1014
Outer Tie Rod End
(Ø13.5*Ø15/M12*1.25)



VO1012
Outer Tie Rod End
(Ø13.5*Ø15/M14*1.5)

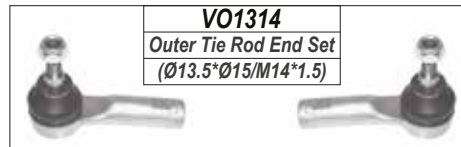

VO1314
Outer Tie Rod End Set
(Ø13.5*Ø15/M14*1.5)

VO1413
Rack End
(16*1.5 /14*1.5/317)

VO1013
Outer Tie Rod End
(Ø13.5*Ø15/M14*1.5)



VO1512
Link Stabilizer
L=200



VO1513
Link Stabilizer
L=267



VO2014
Lower Control Arm

VO2112
Lower Control Arm Bush



VO2015
Lower Control Arm

VO1912
Lower Ball Joint
(Ø15)



VO2113 / VO2114
Lower Control Arm Bush

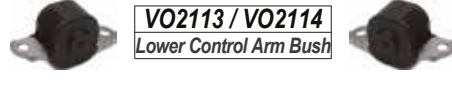

VO1912
Lower Ball Joint
(Ø15)



VO2016
Lower Control Arm
2001-

VO2112
Lower Control Arm Bush



VO2017
Lower Control Arm
2001-

VO2810
Shock Mounting



VO2113 / VO2114
Lower Control Arm Bush



VO2810
Shock Mounting



LEFT

RIGHT

VOLVO

S40 / V40

REAR

Year

1997-2004

VO1514
Link Stabilizer
L=105.5



VO2611
Lateral Link
L=143



VO2610
Lateral Link
L=257



MI2020
Lower Control Arm



MI2021
Lower Control Arm

LEFT

RIGHT

VOLVO

S40 / V50

FRONT

II

Year

2004-2009

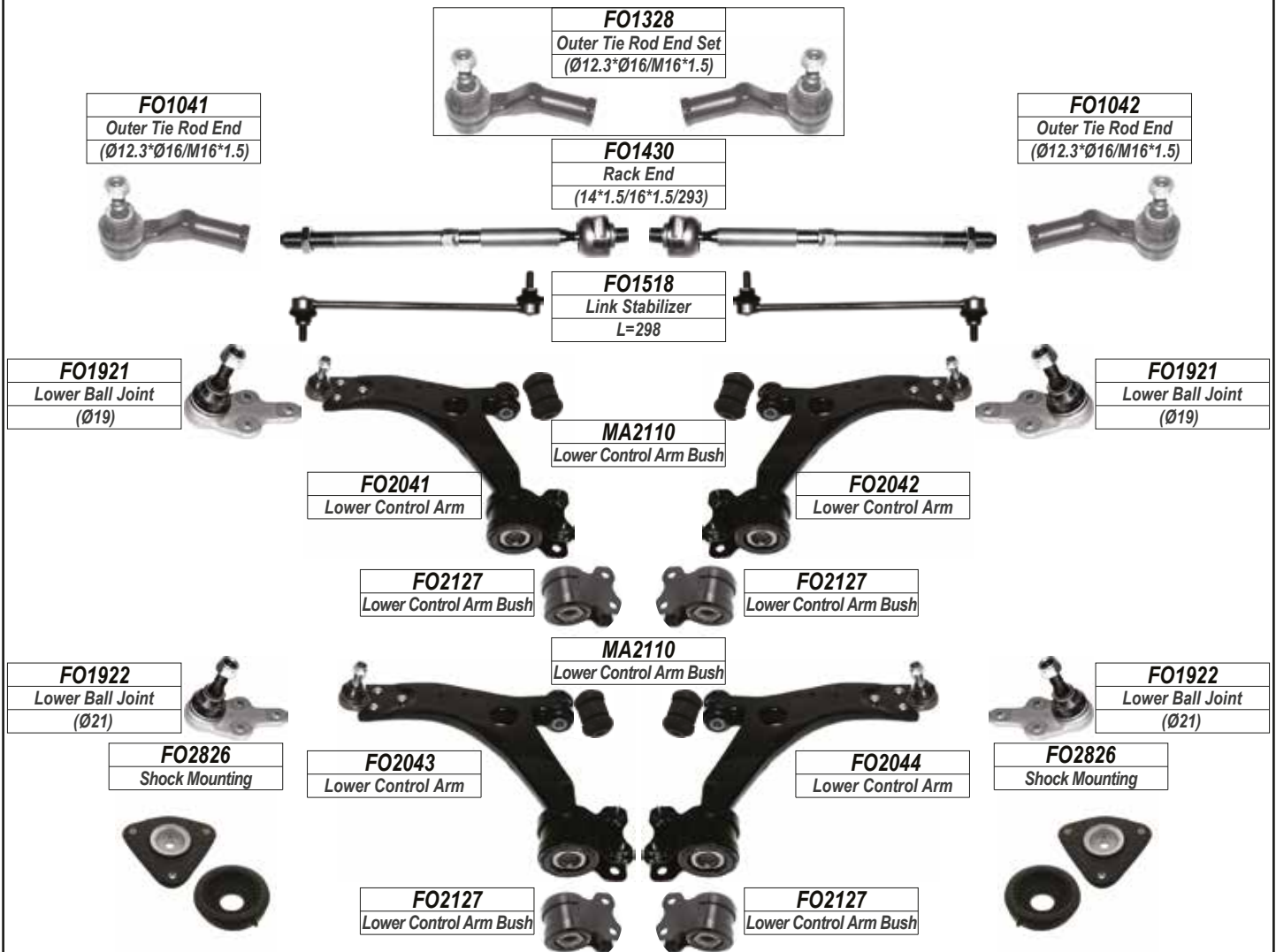

S40 / V50

REAR



LEFT

RIGHT

VOLVO

S60

FRONT

Year

2001-2010

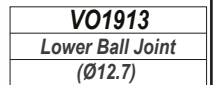
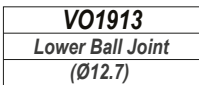
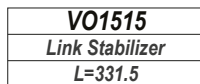
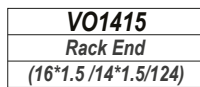
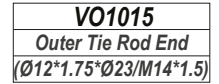
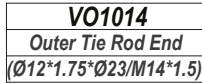
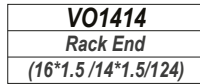

S60

REAR

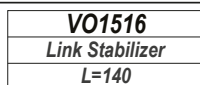

LEFT

RIGHT

VOLVO

S60

FRONT

II

Year

2010-

LR1315
Outer Tie Rod End Set
(Ø16.7*Ø20.1/M18*1.5)

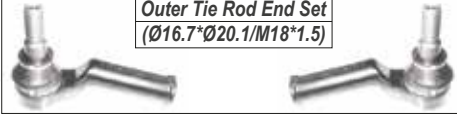

LR1019
Outer Tie Rod End
(Ø16.7*Ø20.1/M18*1.5)



VO1416
Rack End
(16*1.5 /18*1.5/314)



LR1020
Outer Tie Rod End
(Ø16.7*Ø20.1/M18*1.5)



VO1417
Rack End
(16*1.5 /18*1.5/304)



VO1517
Link Stabilizer
L=300

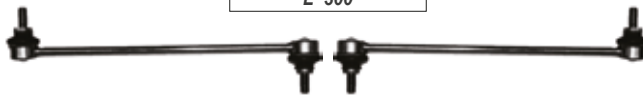

LR2115
Lower Control Arm Bush



VO1914
Lower Ball Joint
(Ø18)



VO1914
Lower Ball Joint
(Ø18)

VO2020
Lower Control Arm

VO2021
Lower Control Arm

VO2813
Shock Mounting



VO2813
Shock Mounting



LR2113 / LR2114
Lower Control Arm Bush

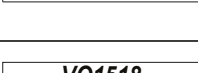

S60

REAR

VO1518
Link Stabilizer
L=179.5

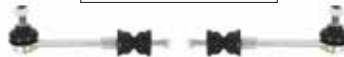

VO1710
Upper Control Arm

VO2612
Lateral Link

VO1711
Upper Control Arm



LEFT

RIGHT

VOLVO

S70

FRONT

ALL MODELS

Year

1997-2000

VO1010
Outer Tie Rod End
(Ø12.93*Ø16.1/M14*2)



VO1310
Outer Tie Rod End Set
(Ø12.93*Ø16.1/M14*2)

VO1011
Outer Tie Rod End
(Ø12.93*Ø16.1/M14*2)



VO1410
Rack End
(14*1.5/14*2/177)



VO1510
Link Stabilizer
L=302

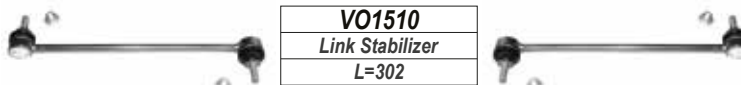

VO2110
Lower Control Arm Bush



VO2010
Lower Control Arm



VO2011
Lower Control Arm



VO1910
Lower Ball Joint
(Ø19)



VO1910
Lower Ball Joint
(Ø19)



VO2111
Lower Control Arm Bush

VO2012
Lower Control Arm



VO2013
Lower Control Arm



VO2814
Shock Mounting



VO2815
Shock Mounting



VO2814
Shock Mounting



VO2815
Shock Mounting



LEFT

RIGHT

VOLVO

S80

FRONT

Year

1999-2006

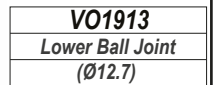
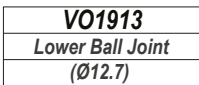
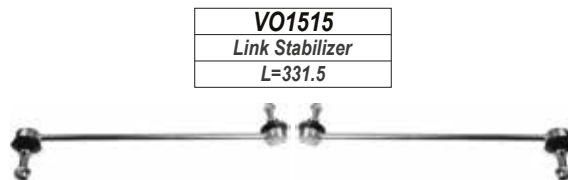
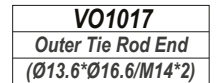
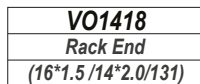
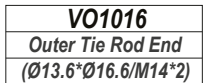
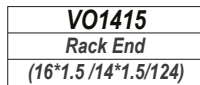
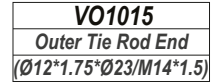
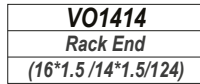
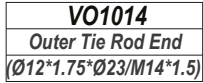

S80

REAR

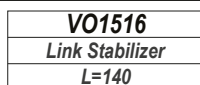

LEFT

RIGHT

VOLVO

S80

FRONT

Year

2006-

II

LR1315
Outer Tie Rod End Set
(Ø16.7*Ø20.1/M18*1.5)

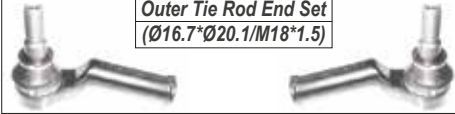

LR1019
Outer Tie Rod End
(Ø16.7*Ø20.1/M18*1.5)



VO1416
Rack End
(16*1.5 / 18*1.5/314)



LR1020
Outer Tie Rod End
(Ø16.7*Ø20.1/M18*1.5)



VO1417
Rack End
(16*1.5 / 18*1.5/304)



VO1517
Link Stabilizer
L=300

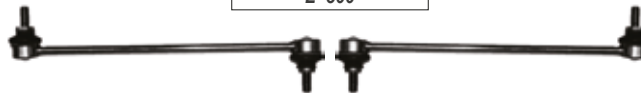

LR2115
Lower Control Arm Bush

Lower Control Arm Bush



VO1914
Lower Ball Joint
(Ø18)



VO2020
Lower Control Arm



VO2021
Lower Control Arm

VO1914
Lower Ball Joint
(Ø18)



VO2813
Shock Mounting



LR2113 / LR2114
Lower Control Arm Bush

Lower Control Arm Bush



VO2813
Shock Mounting



S80

REAR

VO1518
Link Stabilizer
L=179.5

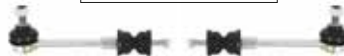

LEFT

RIGHT

VOLVO

S90 / V90

FRONT

ALL MODELS

Year

1997-2000

VO1014
Outer Tie Rod End
(Ø12*1.75*Ø23/M14*1.5)



VO1411
Rack End
(14*1.5/14*2/224)

VO1015
Outer Tie Rod End
(Ø12*1.75*Ø23/M14*1.5)



VO1511
Link Stabilizer
L=245



VO1519
Link Stabilizer
L=140



VO1520
Link Stabilizer
L=64



VO1911
Lower Ball Joint
(Ø15.5)



VO1911
Lower Ball Joint
(Ø15.5)



LEFT

RIGHT

VOLVO

V40

FRONT

ALL MODELS

Year

2013-

VO1018
Outer Tie Rod End
(Ø11.4*Ø18/M16*1.5)

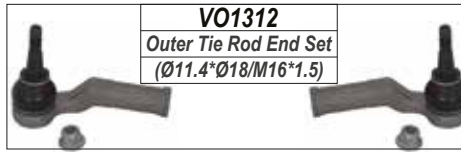

VO1312
Outer Tie Rod End Set
(Ø11.4*Ø18/M16*1.5)

FO1431
Rack End
(14*1.5/16*1.5/290)

VO1019
Outer Tie Rod End
(Ø11.4*Ø18/M16*1.5)



VO1521
Link Stabilizer
L=76.4



FO2129
Lower Control Arm Bush

VO1915
Lower Ball Joint
(Ø21)

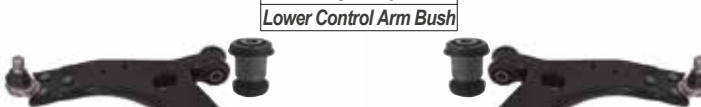

VO1916
Lower Ball Joint
(Ø21)

VO2024
Lower Control Arm

VO2025
Lower Control Arm

FO2128
Lower Control Arm Bush

VO2816
Shock Mounting



VO2816
Shock Mounting



V40

REAR

VO1523
Link Stabilizer
L=50 (1.6)



LEFT

RIGHT

VOLVO

V60

FRONT

ALL MODELS

Year

2011-

LR1019
Outer Tie Rod End
(Ø16.7*Ø20.1/M18*1.5)



LR1315
Outer Tie Rod End Set
(Ø16.7*Ø20.1/M18*1.5)

VO1416
Rack End
(16*1.5 /18*1.5/314)

VO1417
Rack End
(16*1.5 /18*1.5/304)

LR1020
Outer Tie Rod End
(Ø16.7*Ø20.1/M18*1.5)



VO1517
Link Stabilizer
L=300

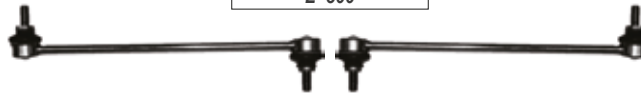

LR2115
Lower Control Arm Bush

VO1914
Lower Ball Joint
(Ø18)



VO2020
Lower Control Arm



LR2113 / LR2114
Lower Control Arm Bush



VO2021
Lower Control Arm



VO1914
Lower Ball Joint
(Ø18)

VO2813
Shock Mounting



VO2813
Shock Mounting



V60

REAR

VO1518
Link Stabilizer
L=179.5

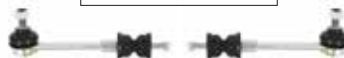

LEFT

RIGHT

VOLVO

V70

FRONT

Year

1997-2000

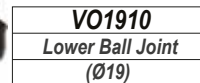
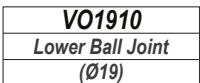
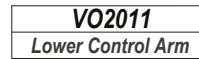
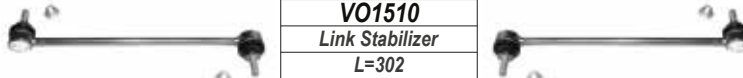
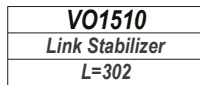
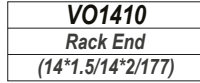
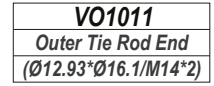
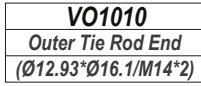

LEFT

RIGHT

VOLVO

V70

FRONT

Year

2000-2007

II

VO1311
Outer Tie Rod End Set
(Ø12*1.75*Ø23/M14*1.5)



VO1414
Rack End
(16*1.5/14*1.5/124)



VO1015
Outer Tie Rod End
(Ø12*1.75*Ø23/M14*1.5)



VO1014
Outer Tie Rod End
(Ø12*1.75*Ø23/M14*1.5)



VO1415
Rack End
(16*1.5/14*1.5/124)



VO1515
Link Stabilizer
L=331.5

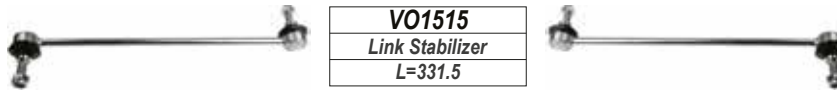

VO1913
Lower Ball Joint
(Ø12.7)



VO1913
Lower Ball Joint
(Ø12.7)



VO2018
Lower Control Arm



VO2019
Lower Control Arm



VO2814
Shock Mounting



VO2814
Shock Mounting



VO2815
Shock Mounting



VO2815
Shock Mounting



V70

REAR

VO1516
Link Stabilizer
L=140



LEFT

RIGHT

VOLVO

V70

FRONT

Year

2007-

III

LR1315
Outer Tie Rod End Set
(Ø16.7*Ø20.1/M18*1.5)

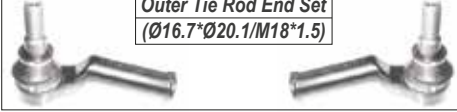

LR1019
Outer Tie Rod End
(Ø16.7*Ø20.1/M18*1.5)



VO1416
Rack End
(16*1.5 /18*1.5/314)



LR1020
Outer Tie Rod End
(Ø16.7*Ø20.1/M18*1.5)



VO1417
Rack End
(16*1.5 /18*1.5/304)



VO1517
Link Stabilizer
L=300



LR2115
Lower Control Arm Bush

Lower Control Arm Bush

VO1914
Lower Ball Joint
(Ø18)



VO2020
Lower Control Arm



VO2021
Lower Control Arm

VO1914
Lower Ball Joint
(Ø18)



LR2113 / LR2114
Lower Control Arm Bush



V70

REAR

VO1518
Link Stabilizer
L=179.5

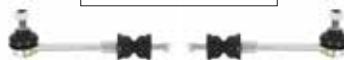

LEFT

RIGHT

VOLVO

XC60

FRONT

ALL MODELS

Year

2008-

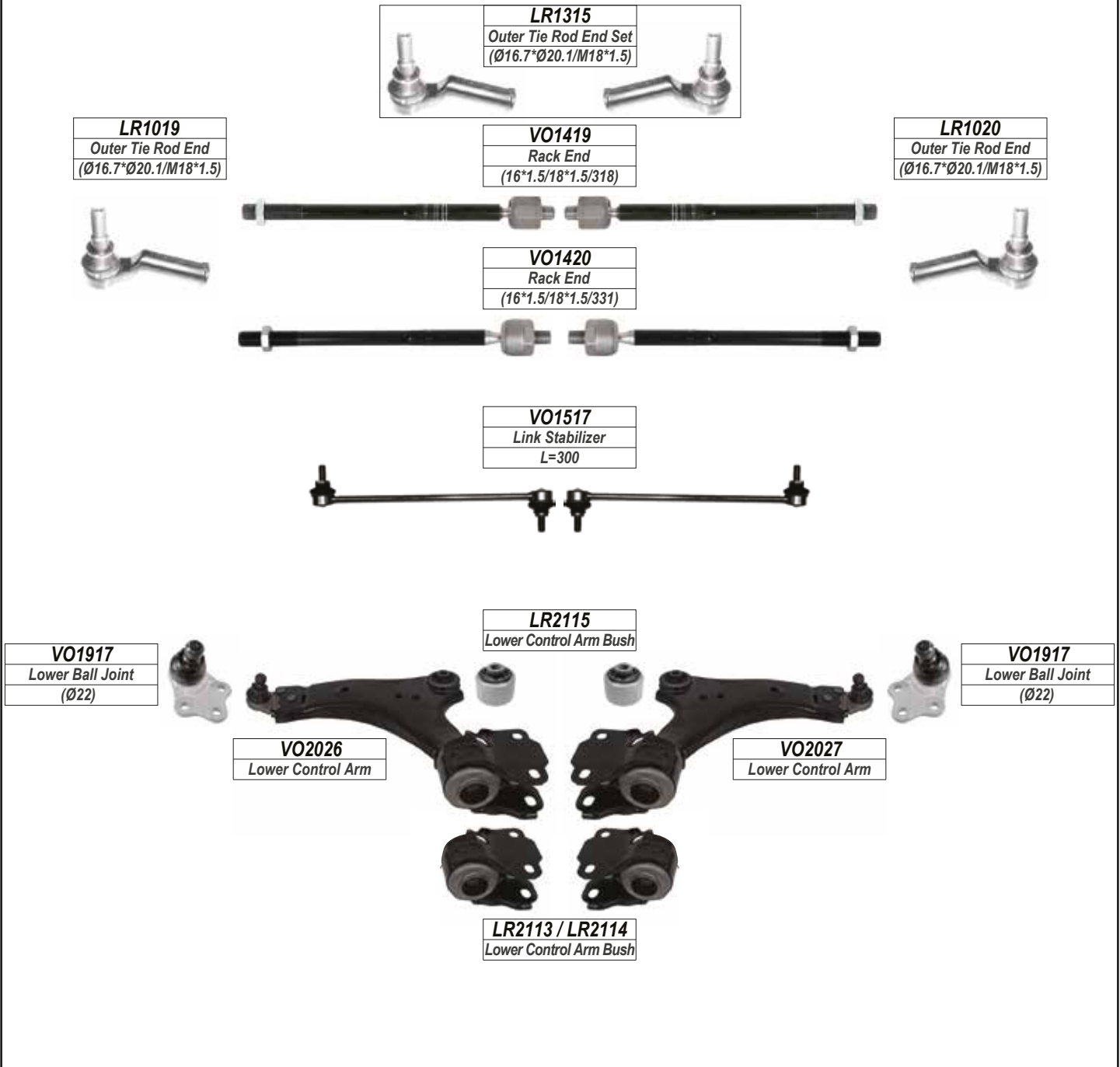

V70

REAR

VO1518
Link Stabilizer
L=179.5

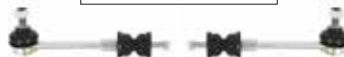

LEFT

RIGHT

VOLVO

XC70

FRONT

ALL MODELS

Year

2000-2007

VO1014
Outer Tie Rod End
(Ø12*1.75*Ø23/M14*1.5)



VO1311
Outer Tie Rod End Set
(Ø12*1.75*Ø23/M14*1.5)

VO1414
Rack End
(16*1.5 /14*1.5/124)



VO1015
Outer Tie Rod End
(Ø12*1.75*Ø23/M14*1.5)



VO1313
Outer Tie Rod End Set
(Ø15*Ø33/M14*1.5)

VO1020
Outer Tie Rod End
(Ø15*Ø33/M14*1.5)



VO1415
Rack End
(16*1.5 /14*1.5/124)



VO1021
Outer Tie Rod End
(Ø15*Ø33/M14*1.5)

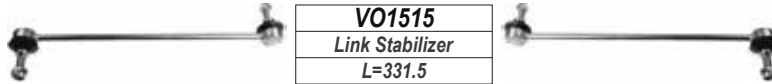

VO1515
Link Stabilizer
L=331.5



VO1517
Link Stabilizer
L=300

VO2116
Lower Control Arm



VO1913
Lower Ball Joint
(Ø12.7)



VO1913
Lower Ball Joint
(Ø12.7)



VO2028
Lower Control Arm

VO2029
Lower Control Arm

VO2814
Shock Mounting



VO2115
Lower Control Arm

VO2814
Shock Mounting



VO2815
Shock Mounting



VO2815
Shock Mounting



LEFT

RIGHT

VOLVO

XC70

FRONT

ALL MODELS

Year

2007-

LR1019
Outer Tie Rod End
(Ø16.7*Ø20.1/M18*1.5)



LR1315
Outer Tie Rod End Set
(Ø16.7*Ø20.1/M18*1.5)

VO1416
Rack End
(16*1.5/18*1.5/314)



LR1020
Outer Tie Rod End
(Ø16.7*Ø20.1/M18*1.5)



VO1517
Link Stabilizer
L=300

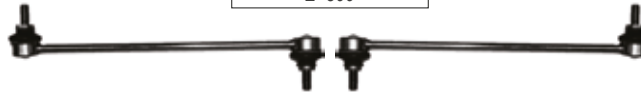

LR2115
Lower Control Arm Bush

VO1917
Lower Ball Joint
(Ø22)



VO2026
Lower Control Arm

VO2027
Lower Control Arm

VO1917
Lower Ball Joint
(Ø22)



LR2113 / LR2114
Lower Control Arm Bush

VO2813
Shock Mounting



VO2813
Shock Mounting



XC70

REAR

VO1518
Link Stabilizer
L=179.5

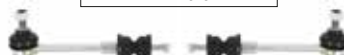

LEFT

RIGHT

VOLVO

XC90

FRONT

ALL MODELS

Year

2003-2014

VO1313
Outer Tie Rod End Set
(Ø12*Ø33/M14*1.5)



VO1414
Rack End
(16*1.5 / 14*1.5/124)



VO1020
Outer Tie Rod End
(Ø12*Ø33/M14*1.5)



VO1021
Outer Tie Rod End
(Ø12*Ø33/M14*1.5)



VO1415
Rack End
(16*1.5 / 14*1.5/124)



VO1515
Link Stabilizer
L=331.5

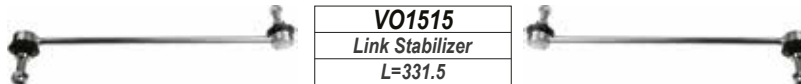

VO2117
Lower Control Arm Bush



VO1918
Lower Ball Joint
(Ø14.74)



VO1918
Lower Ball Joint
(Ø14.74)



VO2030
Lower Control Arm



VO2031
Lower Control Arm

VO2811
Shock Mounting



VO2811
Shock Mounting



VO2118
Lower Control Arm Bush

VO2812
Shock Mounting



VO2812
Shock Mounting



XC90

REAR

VO1516
Link Stabilizer
L=140



LEFT

RIGHT



teknosa[®]
STEERING & SUSPENSION PARTS

✉ info@teknosa.co.za

🌐 www.teknosa.co.za



2022/23

**STEERING & SUSPENSION
PARTS CATALOGUE**
FOR PASSENGER & LIGHT COMMERCIAL VEHICLES